

W

1969

Preferred Semiconductors and Components from Texas Instruments

a selection of popular, readily available discrete semiconductors
and components for new and present circuit designs.

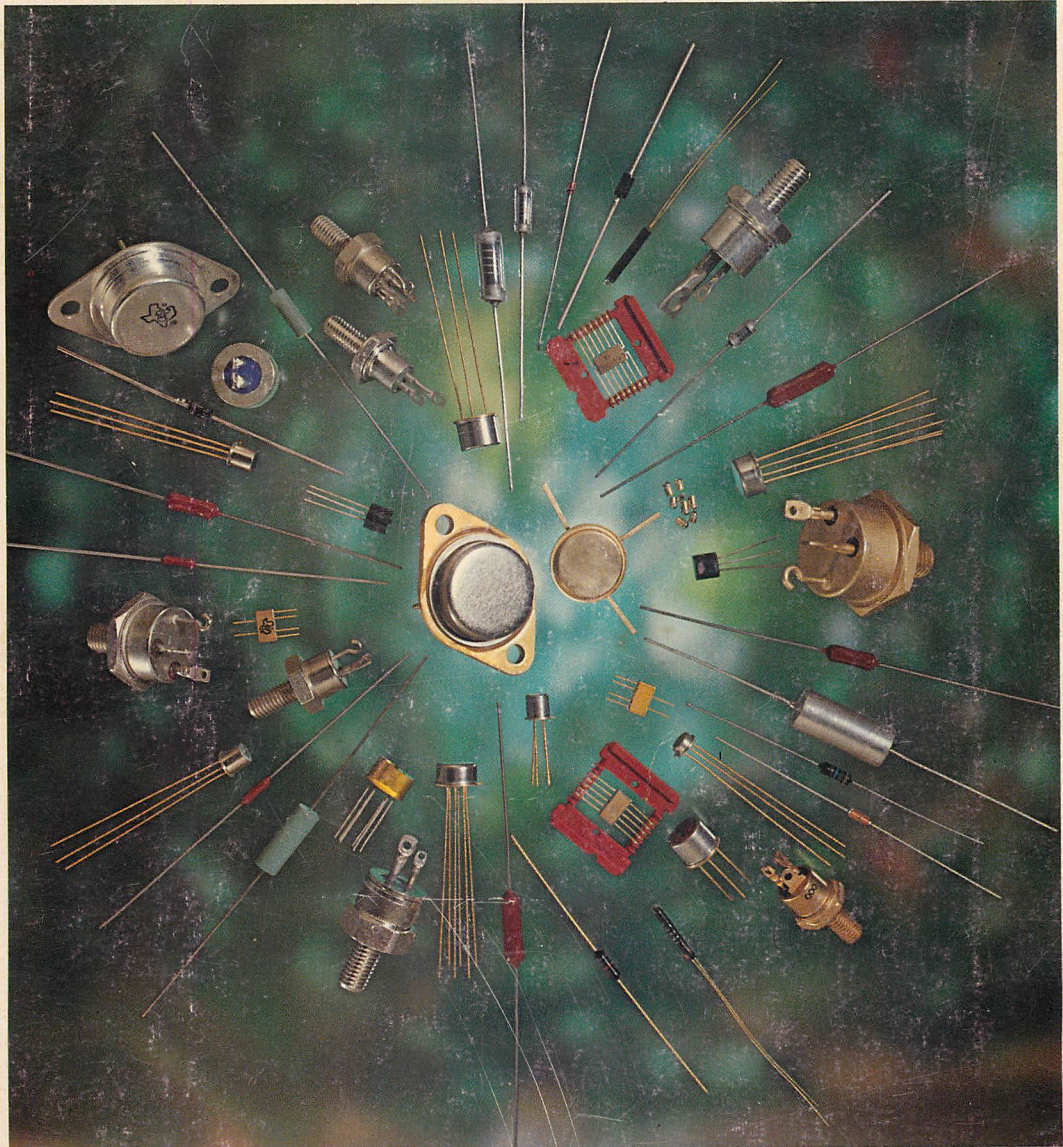

A TOTALLY NEW KIND OF CATALOG

Here's how to use it:

TI makes more than 14,800 different types of standard and special discrete semiconductors and passive electronic components. But this catalog includes detailed specifications on only 289.

Months of computer demand analysis reveal that these 289 types will meet the vast majority of your requirements. They are workhorse devices — customer preferred devices — all in wide use today, readily available from distributor or TI stocks, and in volume production that spells low prices. By specifying preferred TI products, you save design time, reduce purchasing costs, cut inventory requirements, and increase the certainty of on-time delivery. That makes this the most helpful semiconductor catalog you've ever used.

Preferred products are readily identifiable by their **bold numbers** at the top of the first page of each data sheet.

Holders of TI's 1967-68 Semiconductors and Components Catalog are urged to continue using their catalogs as a total index of specification data to the standard TI line. While improvement in ratings and characteristics of many devices are included in this catalog, most of the data sheets listed in the 1967-68 Semiconductors and Components Catalog are current.

A cross-reference guide between JEDEC or competitive type numbers and TI devices is presented on Pages 15-38.

Should you have interest in a device not listed as a preferred device, please check the Index to All Standard Discrete Semiconductors and Components shown on Pages 39-45. You may obtain specification data for any of these devices by writing to Inquiry Answering Service, Texas Instruments Incorporated, MS 980, P.O. Box 5621, Dallas, Texas 75222, specifying the device by type number.

Note that certain blocks of page numbers have intentionally been omitted to anticipate new products which may be added in future editions.

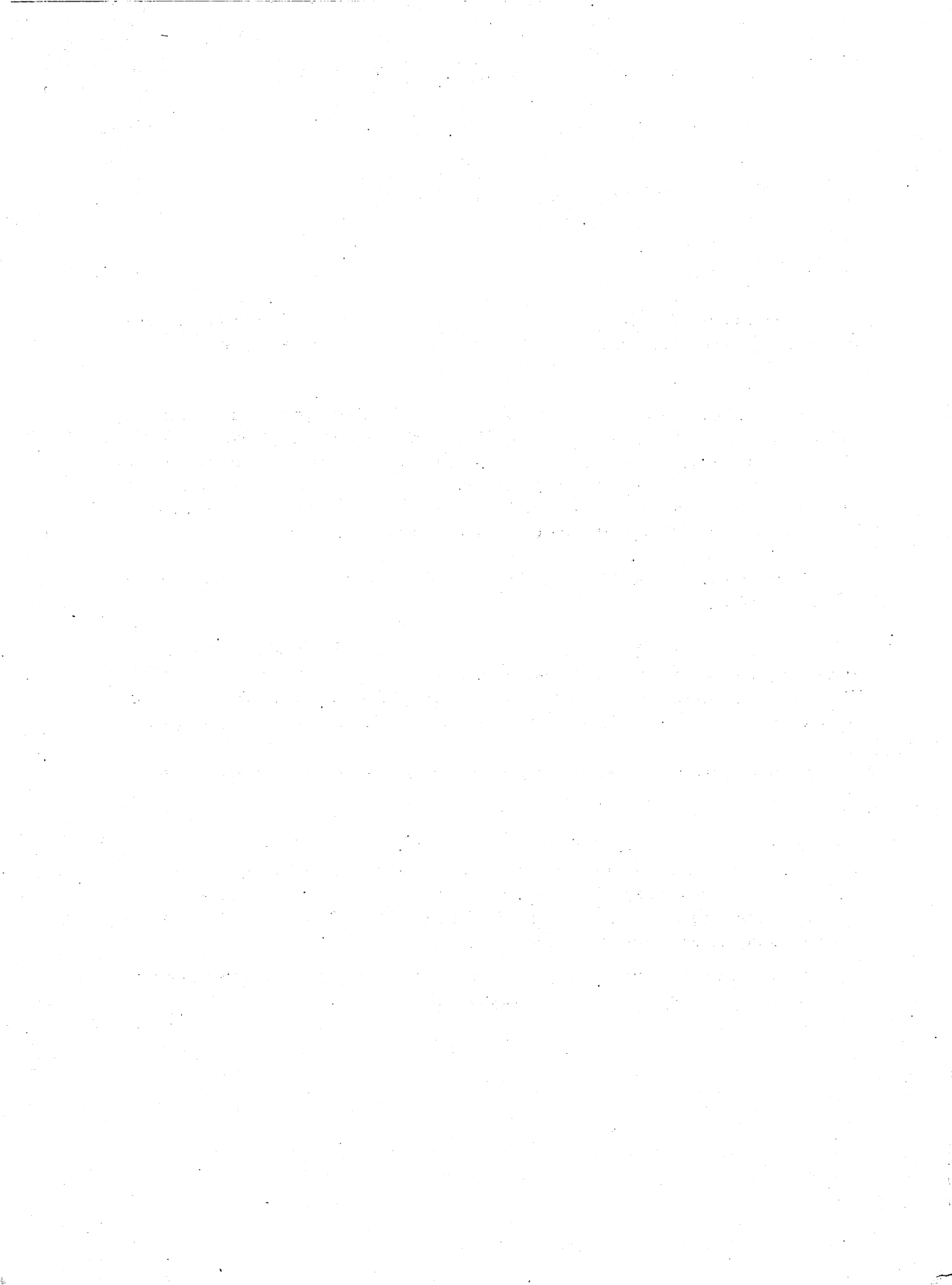

Preferred Semiconductors and Components from Texas Instruments

CONTENTS

	Page
How to Use the Indexes	2
Listing of Preferred Semiconductors and Components by Device Classification	3
Application Guide to Preferred Semiconductors and Components	5
Selection Guide to Preferred Silicon Power Transistors	11
Cross-Reference Guide Between JEDEC or Competitive Type Numbers and TI Devices	15
Index to All Standard Discrete Semiconductors and Components Manufactured by TI	39
Listing of Military Devices Available from TI	46

TEXAS INSTRUMENTS
INCORPORATED
POST OFFICE BOX 5012 • DALLAS, TEXAS 75222

HOW TO USE THE INDEXES

If you know only the **category of device**, look in the **Listing of Preferred Semiconductors and Components**, page 3.

If you want a device for a **particular application**, look in the **Application Guide to Preferred Semiconductors and Components**, page 5, also see pages 11-14 for Silicon Power devices.

If you are seeking the **TI device nearest** to a JEDEC or competitive type number, look in the **Cross-Reference Guide Between JEDEC or Competitive Type Numbers and TI Devices**, starting on page 15.

If you know the **Texas Instruments device number**, look in the **Index to All Standard Discrete Semiconductors and Components**, page 39.

SPECIAL INFORMATION

TI Field Sales Office Addresses, page 1332

TI Microlibrary Information, page 1524

Standard Mounting Hardware for Silicon Thyristors, page 24001

IMPORTANT NOTICES

Texas Instruments reserves the right to make changes at any time in order to improve design and to supply the best product possible.

TI cannot assume any responsibility for any circuits shown or represent that they are free from patent infringement.

**LISTING OF PREFERRED SEMICONDUCTORS AND COMPONENTS
BY DEVICE CLASSIFICATION (Cont'd.)**

**REGULATOR DIODES
(Cont'd.)**

1N758A	23109
1N759	23109
1N759A	23109
1N4370	23601
1N4370A	23601
1N4371	23601
1N4371A	23601
1N4372	23601
1N4372A	23601

**THYRISTORS AND
TRIGGER DIODES†**

TIC20	24101
TIC21	24101
TIC22	24101
TIC23	24101
T142A	24105
T143A	24105
TIC44	24109
TIC45	24109
TIC46	24109
TIC47	24109
2N3001	24401
2N3002	24401
2N3003	24401
2N3004	24401
2N3005	24407
2N3006	24407
2N3007	24407
2N3008	24407
2N3555	24417
2N3556	24417
2N3557	24417
2N3558	24417
2N3559	24425
2N3560	24425
2N3561	24425
2N3562	24425
2N5273	24601
2N5274	24601

SILICON RECTIFIERS

1N4001	25401
1N4002	25401
1N4003	25401
1N4004	25401
1N4005	25401
1N4006	25401
1N4007	25401

**OPTOELECTRONIC
DEVICES**

LS400	27401
LS600	27501
1N2175	27801

**PRECISION FILM
RESISTORS**

CG1/8	28201
CG1/4	28201
CG1/2	28201
MC55	28401
MC55D	28401
MC60	28401
MC60D	28401
MC65	28401
MC65D	28401

**TEMPERATURE-SENSING
SILICON RESISTORS**

TG1/8	29001
TM1/8	29003
TM1/4	29003

†See page 24001 for standard mounting hardware.

APPLICATIONS GUIDE TO PREFERRED SEMICONDUCTORS AND COMPONENTS

APPLICATION	DEVICE RECOMMENDATION								
	BIPOLAR				FET				
	N-P-N		P-N-P		N-CHANNEL		P-CHANNEL		
	Type No.	Page No.	Type No.	Page No.	Type No.	Page No.	Type No.	Page No.	
Small-Signal Transistor: Amplifier:	• TIS92	4105	• TIS93	4105	TIS88	6111	2N2386	6301	
	• TIS92M	4105	• TIS93M	4105	• 2N3819	6401	• 2N2498	6303	
DC to 1 MHz	• TIS97	1047	2N404	9105	• 2N3822	6405	• 2N3330	6305	
	• TIS98	1047	2N1303	9205			2N3909	6413	
	TIS99	1047	2N1305	9205			• 2N3820	6403	
	2N697	1201	2N1307	9205					
	2N718A	1201	2N1309	9205					
	2N930	1269	2N2000	9307					
	• 2N997	4301	2N2605	2119					
	• 2N1302	9205	• 2N2905	2127					
	• 2N1304	9205	• 2N2907	2127					
	• 2N1306	9205	• 2N3486	2213					
	• 2N1308	9205	• 2N3495	2215					
	2N1893	1209	• 2N3964	2241					
	• 2N2484	1337	• 2N4058-61	2301					
	2N3707	1431	• 2N5447	2305					
	2N3708	1431							
	2N3709	1431							
	2N3710	1431							
	2N3711	1431							
	• 2N4104	1501							
	• 2N5449	1701							
1 MHz to 10 MHz	TIS63	1025	• TIS37	2001	TIS88	6111	2N2386	6301	
	2N697	1201	2N404	9105	• 2N3819	6401	• 2N2498	6303	
	2N930	1269	2N1303	9205	• 2N3822	6405	• 2N3330	6305	
	2N1302	9205	2N1305	9205	• 2N3823	6407	2N3909	6413	
	2N1304	9205	2N1307	9205	• 2N4416	6503	• 2N3820	6403	
	2N1306	9205	2N1309	9205					
	2N1308	9205	2N1377	9213					
	2N1613	1201	2N1997	9301					
	2N1893	1209	2N2605	2119					
	• 2N2484	1337	• 2N2905	2127					
	• 2N4104	1501	• 2N3495	2215					
	• 2N4995	1441							
	• 2N4996	1511							
	10 MHz to 50 MHz	TIS56	1021	• TIS37	2001	TIS88	6111	• 2N2498	6303
• TIS63		1025	• 2N3495	2215	• 2N3819	6401	• 2N3330	6305	
• TIS84		1033	• 2N5043	14401	• 2N3822	6405			
• TIS85		1033			• 2N3823	6407			
• TIS86		1041			• 2N4416	6503			
• TIS87		1041							
2N918		3201							
• 2N2219		1305							
• 2N2222		1305							
• 2N2243A		1301							
2N4252		1503							
• 2N4996		1511							
50 MHz to 100 MHz		• TIS63	1025	• 2N2905	2127	TIS88	6111	• 2N2498	6303
		• TIS84	1033	• 2N2907	2127	• 2N3823	6407	• 2N3330	6305
	• TIS85	1033	• 2N3486	2213	• 2N4416	6503			
	• TIS86	1041	• 2N5043	14401					
	• TIS87	1041							
	2N918	3201							
	• 2N2219	1305							
	• 2N2222	1305							
	2N4252	1503							
	• 2N4875	3701							
• 2N4996	1511								
100 MHz to 5 GHz	2N918	3201	• 2N5043	14401	TIS88	6111			
	• 2N3570	3401			• 2N3823	6407			
	2N4252	1503			• 2N4416	6503			
	• 2N4875	3701							

• Devices especially recommended for new design.

**APPLICATIONS GUIDE TO
PREFERRED SEMICONDUCTORS AND COMPONENTS (Cont'd.)**

APPLICATION	DEVICE RECOMMENDATION							
	BIPOLAR				FET			
	N-P-N		P-N-P		N-CHANNEL		P-CHANNEL	
	Type No.	Page No.	Type No.	Page No.	Type No.	Page No.	Type No.	Page No.
Low-Noise Amplifier: 0 to 10 MHz	•TIS97	1047	•TIS37	2001	TIS88	6111	•2N2498	6303
	2N930	1269	2N2605	2119	•2N3822	6405	•2N3330	6305
10 MHz to 50 MHz	•2N2484	1337	•2N4058-61	2301	•2N4416	6503		
	2N3707	1431						
50 MHz to 100 MHz	•2N4104	1501						
	•TIS62	1025	•TIS37	2001	TIS88	6111		
100 MHz to 1 GHz	•TIS84	1033			•2N3822	6405		
	•TIS86	1041			•2N3823	6407		
Mixer and Converter: 0 to 10 MHz	2N918	3201	•2N5043	14401	•2N4416	6503	•2N2498	6303
	•2N4995	1441					•2N3330	6305
10 MHz to 50 MHz	TIS56	1021	•TIS37	2001	•TIS88	6111	•2N3820	6403
	•TIS63	1025			•2N3823	6407		
50 MHz to 100 MHz	•TIS85	1033			•2N4416	6503		
	•TIS86	1041						
100 MHz to 5 GHz	2N4252	1503						
	•2N4875	3701						
Oscillator: 0 to 10 MHz	•2N4995	1441						
	•TIS63	1025	•2N5043	14401	•TIS88	6111	•2N2498	6703
10 MHz to 50 MHz	•TIS85	1033			•2N3823	6407	•2N3330	6305
	•TIS86	1041			•2N4416	6503		
0 to 10 MHz	•2N3570	3401						
	2N4252	1503						
10 MHz to 50 MHz	•2N4875	3701						
	•2N4995	1441						
0 to 10 MHz	•TIS86	1041	•2N5043	14401	•TIS88	6111	•2N2498	6703
	2N918	3201			•2N3823	6407	•2N3330	6305
10 MHz to 50 MHz	•2N3570	3401			•2N4416	6503		
	2N4252	1503						
0 to 10 MHz	•2N4875	3701						
	•2N4995	1441						
10 MHz to 50 MHz	•TIS98	1047	•TIS38	2001	•TIS88	6111	•2N2498	6703
	2N697	1201	•2N2905	2127	•2N3819	6401	•2N3330	6305
10 MHz to 50 MHz	2N1613	1201	•2N3486	2213	•2N3822	6405		
	•2N2484	1337	•2N3495	2215	•2N3823	6407		
10 MHz to 50 MHz	2N3711	1431			•2N4416	6503		
	•2N5449	1701						
10 MHz to 50 MHz	•TIS63	1025	•TIS38	2001	•TIS88	6111		
	•TIS98	1047	•2N2905	2127	•2N3822	6405		
10 MHz to 50 MHz	2N918	3201	•2N2907	2127	•2N3823	6407		
	•2N2219	1305	•2N3486	2213	•2N4416	6503		
10 MHz to 50 MHz	•2N2222	1305	•2N5447	2305				
	•2N4875	3701						
10 MHz to 50 MHz	•2N5449	1701						

• Devices especially recommended for new design.

**APPLICATIONS GUIDE TO
PREFERRED SEMICONDUCTORS AND COMPONENTS (Cont'd.)**

APPLICATION	DEVICE RECOMMENDATION			
	BIPOLAR		FET	
	N-P-N	P-N-P	N-CHANNEL	P-CHANNEL
	Type No. Page No.	Type No. Page No.	Type No. Page No.	Type No. Page No.
50 MHz to 100 MHz	•TIS63 1025 •TIS86 1041 2N918 3201 •2N4875 3701 •2N5449 1701	•2N5043 14401 •2N5447 2305	TIS88 6111 •2N3823 6407 •2N4416 6503	
100 MHz to 5 GHz	•TIS63 1025 •TIS86 1041 2N918 3201 •2N3570 3401 •2N4875 3701	•2N5043 14401	TIS88 6111 •2N3823 6407 •2N4416 6503	
Power Oscillator:	•2N3866 3501			
Power Amplifier: Radio Frequency	•2N3866 3501 •2N4875 3701			
Audio Frequency	•TIP29 16101 •TIP29A 16101 •TIP31 16109 •TIP31A 16109 •TIP33 16117 •TIP33A 16117 •TIP35 16125 •TIP35A 16125 2N697 1201 2N718A 1201 2N1613 1201 2N1711 1201	•TIP30 16105 •TIP30A 16105 •TIP32 16113 •TIP32A 16113 •TIP34 16121 •TIP34A 16121 •TIP36 16129 •TIP36A 16129 2N456A 17101 2N1038 17201 •2N2905 2127 •2N2907 2127 TI3027 17301 •2N3486 2213 •2N3495 2215	•2N4857 6511	

	BIPOLAR		OTHER DEVICES	
	N-P-N	P-N-P	Type No. Page No.	Classification
	Type No. Page No.	Type No. Page No.	Type No. Page No.	
Switching: Multivibrator, Pulse Generator, Schmitt Trigger	2N1302 9205 2N1304 9205 2N1306 9205 2N1308 9205 •2N2219 1305 •2N2222 1305 •2N2369A 1315 •2N3010 1401 •2N3013 1405 •2N3725 1433 •2N4418 1519 •2N4420 1521	2N404 9105 2N1303 9205 2N1305 9205 2N1307 9205 2N1309 9205 2N1997 9301 2N2000 9307 2N2635 12301 •2N2894 2125 •2N2905 2127 •2N2907 2127 •2N3829 2235 •2N4423 2303	•2N3980 7201 •2N3993 6501 •2N4416 6503 •2N4857 6511	UJT P-FET N-FET N-FET
Ring Counter/ Latching Amplifier	2N930 1269 •2N2369A 1315 •2N3010 1401 •2N3013 1405 •2N4418 1519 •2N4420 1521 •2N5449 1701	•2N2894 2125 •2N2905 2127 •2N3250 2209 •2N3304 2211 •2N3829 2235 •2N4058-61 2301 •2N5447 2305	•TIC20-3 24101 •2N3001-4 24401 •2N3555-8 24417 •2N3993 6501 •2N4416 6503 •2N4857 6511 •2N5273-4 24601 •TIS73 6103	TRIAC SCR SCR P-FET N-FET N-FET TRIAC N-FET
Relaxation Oscillator			•TI42A 24105 •TI43A 24105 2N1671B 7109 •2N3980 7201 •2N4891 7301	Trigger Diode Trigger Diode UJT UJT UJT

• Devices especially recommended for new design.

**APPLICATIONS GUIDE TO
PREFERRED SEMICONDUCTORS AND COMPONENTS (Cont'd.)**

APPLICATION	DEVICE RECOMMENDATION						
	BIPOLAR				OTHER DEVICES		
	N-P-N		P-N-P		Type No.	Page No.	Classification
Type No.	Page No.	Type No.	Page No.	Type No.	Page No.		
Pulse Amplifier	• 2N2243A	1301	2N1907	17231	• 2N3993	6501	P-FET
	• 2N2369A	1315	• 2N2894	2125	• 2N4857	6511	N-FET
			• 2N2905	2127			
			• 2N3304	2211			
			• 2N3486	2213			
			• 2N3829	2235			
			• 2N5333	16701			
			• 2N5384	16707			
			• 2N5386	16711			
Chopper	• 3N79	4101	• 3N111	4109	• 2N3993	6501	P-FET
	• 2N2432	1325	• 2N2945A	2131	• 2N4857	6511	N-FET
	• TIP29	16101	• 2N3467	2203			
	• TIP29A	16101	• TIP30	16105			
	• TIP31	16109	• TIP30A	16105			
	• TIP31A	16109	• TIP32	16113			
	• TIP33	16117	• TIP32A	16113			
	• TIP33A	16117	• TIP34	16121			
	• TIP35	16125	• TIP34A	16121			
	• TIP35A	16125	• TIP36	16129			
			• TIP36A	16129			
Computer Memory Driver	• 2N3013	1405	• 2N3467	2203	• 2N3993	6501	P-FET
	• 2N3015	1409			• 2N4857	6511	N-FET
	• 2N3725	1433			• T1S73	6103	N-FET
Power Control/Regulator (See Selection Guide on pages 11 - 14)	• TIP29	16101	• TIP30	16105	• TIC20-3	24101	TRIAC
	• TIP29A	16101	• TIP30A	16105	• TIC44-7	24109	SCR
	• TIP31	16109	• TIP32	16113	• 2N3001-4	24401	SCR
	• TIP31A	16109	• TIP32A	16113	• 2N3005-08	24407	SCR
	• TIP33	16117	• TIP34	16121	• 2N3555-8	24417	SCR
	• TIP33A	16117	• TIP34A	16121	• 2N3559-62	24425	SCR
	• TIP35	16125	• TIP36	16129	• 2N5273-4	24601	TRIAC
	• TIP35A	16125	• TIP36A	16129			
	• 2N1724	16301	2N456A	17101			
	• 2N2987-94	16401	2N1539	17223			
	• 2N3055	16409	2N1907	17231			
	• 2N3418-21	16501	T13027	17301			
	• 2N3551,2	16507	• 2N5333	16701			
	• 2N3713-16	16511	• 2N5384,5	16707			
	• 2N3996-9	16601	• 2N5386	16711			
	• 2N4000,1	16607					
	• 2N4002,3	16613					
	• 2N4300	16625					
	• 2N4301	16631					
	• 2N5387-9	16715					
Computer Logic Switch	2N797	12101	2N404	9105	• 2N3993	6501	P-FET
	2N1302	9205	2N964	12105	• 2N4857	6511	N-FET
	2N1304	9205	2N1303	9205	• T1S73	6103	N-FET
	2N1306	9205	2N1305	9205			
	2N1308	9205	2N1307	9205			
	• 2N2369A	1315	2N1309	9205			
	• 2N3010	1401	2N1997	9301			
	• 2N3013	1405	2N2635	12301			
	• 2N4418	1519	• 2N2894	2125			
	• 2N4420	1521	• 2N3250	2209			
			• 2N3304	2211			
			• 2N3829	2235			
			• 2N4423	2303			

• Devices especially recommended for new design

**APPLICATIONS GUIDE TO
PREFERRED SEMICONDUCTORS AND COMPONENTS (Cont'd.)**

APPLICATION	DEVICE RECOMMENDATION						
	BIPOLAR				OTHER DEVICES		
	N-P-N		P-N-P		Type No.	Page No.	Classification
Type No.	Page No.	Type No.	Page No.	Type No.	Page No.		
Series/Shunt Register	• TIP29	16101	• TIP30	16105	• 2N3993	6501	P-FET
	• TIP29A	16101	• TIP30A	16105	• 2N4857	6511	N-FET
	• TIP31	16109	• TIP32	16113			
	• TIP31A	16109	• TIP32A	16113			
	• TIP33	16117	• TIP34	16121			
	• TIP33A	16117	• TIP34A	16121			
	• TIP35	16125	• TIP36	16129			
	• TIP35A	16125	• TIP36A	16129			
	2N1724	16301	2N456A	17101			
	• 2N2987-94	16401	2N1038	17201			
	2N3055	16409	2N1539	17223			
	• 2N3418-21	16501	2N1907	17231			
	• 2N3551,2	16507	TI3027	17301			
	• 2N3713-16	16511	• 2N5333	16701			
	• 2N3996-9	16601	• 2N5384,5	16707			
	• 2N4000,1	16607	• 2N5386	16711			
	• 2N4002,3	16613					
	• 2N4300	16625					
	• 2N4301	16631					
	• 2N5387-9	16715					
Lamp Driver (Nixie Driver) High Voltage	2N1893	1209	2N398	9101	• 2N4857	6511	N-FET
	• 2N2243A	1301	• 2N3495	2215			
Linear Application: Demodulator	• 3N79	4101	2N1907	17231	• 2N4857	6511	N-FET
	• 2N2432	1325	• 2N2945A	2131			
Differential Amplifier	• 2N2060	4401	• 2N3049	4503	• TIS69	6101	N-FET
	• 2N2642	4405	• 2N3350	4507	• 2N5045	6601	N-FET
	• 2N3043	4501	• 2N3351	4507			
	• 2N3045	4501					
	• 2N3680	4509					
	• 2N3838	4517					
Operational Amplifier	• 2N2060	4401	• 2N3049	4503	• TIS69	6101	N-FET
	• 2N2223	4401	• 2N3350	4507	• 2N4854	4701	NPN-PNP
	• 2N2642	4405	• 2N3351	4507	• 2N5045	6601	N-FET
	• 2N3043	4501					
	• 2N3045	4501					
Servo Amplifier	• 2N2060	4401	2N1038	17201	• TIS69	6101	N-FET
	• 2N2223	4401	2N1907	17231	• 2N5045	6601	N-FET
	• 2N2642	4405	• 2N3350	4507			
	• 2N3680	4509	• 2N3351	4507			
Sense Amplifier/ Comparator	• 2N2060	4401	• 2N3049	4503	TIS88	6111	N-FET
	• 2N2642	4405	• 2N3350	4507	• 2N4416	6503	N-FET
	• 2N3043	4501	• 2N3351	4507	• 2N5045	6601	N-FET
	• 2N3680	4509					
	• 2N3838	4517					
Waveform Generator/ Clipper/Compressor	2N930	1269	• 2N5447	2305	TIS88	6111	N-FET
	2N3707	1431			• 2N4416	6503	N-FET
	2N3708	1431			• 2N4857	6511	N-FET
	2N3709	1431					
	2N3711	1431					
	• 2N5449	1701					
Diodes: Mixer/Converter					1N456-8	18101	
					1N482-5	18105	
					1N914	19201	

• Devices especially recommended for new design.

**APPLICATIONS GUIDE TO
PREFERRED SEMICONDUCTORS AND COMPONENTS (Cont'd.)**

APPLICATION	DEVICE RECOMMENDATION					
	BIPOLAR				OTHER DEVICES	
	N-P-N		P-N-P		Type No.	Page No.
	Type No.	Page No.	Type No.	Page No.	Type No.	Page No.
						Classification
Detector					1N456-8 18101 1N914 19201 ●1N4148 19401 ●1N4448 19401	
Switch					1N914 19201 ●1N3064 19301 ●1N3070 19303 ●1N4148 19401 ●1N4448 19401 ●1N4531 19407	200 V
Tuning					●T1V306-08 21205	Voltage Variable
Voltage Regulator					1N746- 1N759 23109 ●1N746A- 1N759A 23109 1N4370 23601 ●1N4370A 23601	
Rectifier					1N456- 1N458 18101 1N482-5 18105 ●1N645-9 18109 ●1N4001-7 25401	
Computer					●T1D21-24 20005 ●T1D25-26 20009 ●T1D29-30 20013 1N914 19201 ●1N3064 19301	8-Diode Array 16-Diode Array 20-Diode Array
Transistor Biasing					●1N746A- 1N759A 23109	
TV "Color Killer"					●1N3070 19303	
Power Supply					●1N645-9 18109	
Logarithmic					●1N645-9 18109 ●1N746A- 1N759A 23109	
Light Sensor					●LS400 27401 ●LS600 27501 ●1N2175 27801	

● Devices especially recommended for new design.

SELECTION GUIDE SILICON POWER TRANSISTORS

The following curves, arranged in ascending order of rated power dissipation, show typical h_{FE} versus collector current at 25°C case temperature. Listed above each curve are the standard open-base collector-emitter voltage ratings available from among the device types listed.

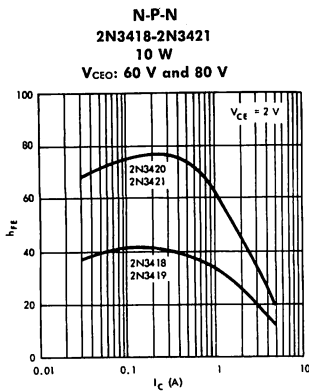

FIGURE 1

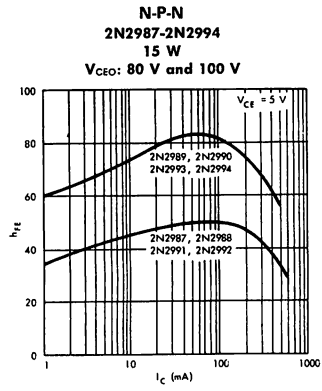

FIGURE 2

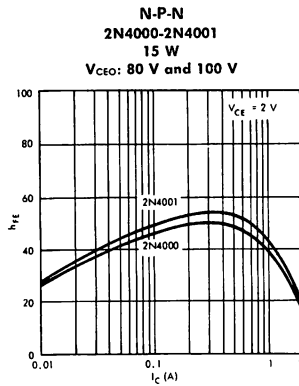

FIGURE 3

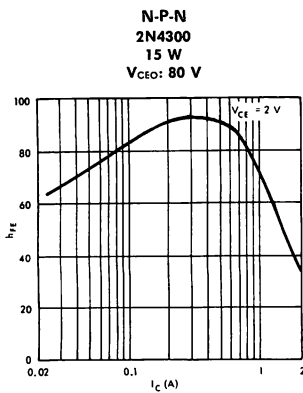

FIGURE 4

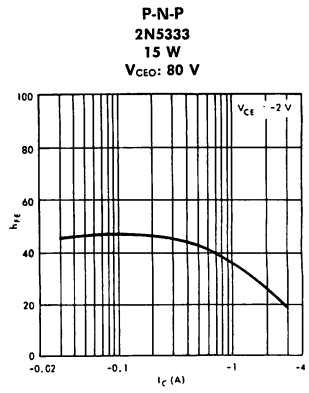

FIGURE 5

SELECTION GUIDE SILICON POWER TRANSISTORS

N-P-N
TIP29, TIP29A
30 W
 V_{CE0} : 40 V and 60 V

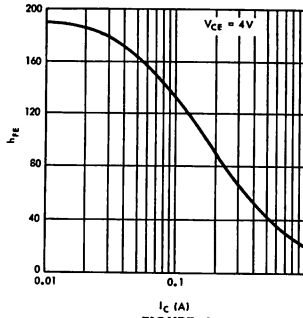

FIGURE 6

P-N-P
TIP30, TIP30A
30 W
 V_{CE0} : 40 V and 60 V

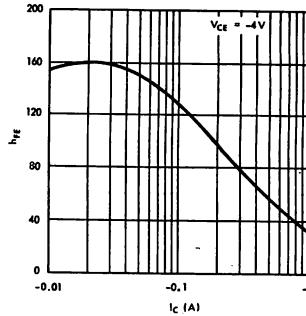

FIGURE 7

N-P-N
2N3996-2N3999
30 W
 V_{CE0} : 80 V

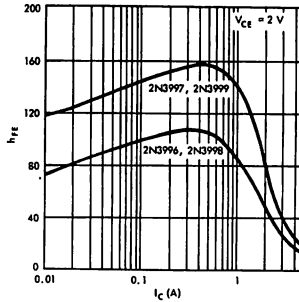

FIGURE 8

N-P-N
TIP31, TIP31A
40 W
 V_{CE0} : 40 V and 60 V

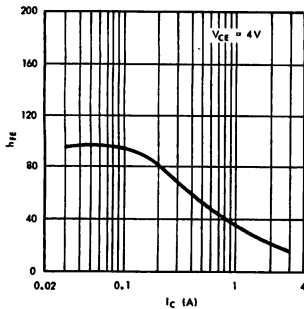

FIGURE 9

P-N-P
TIP32, TIP32A
40 W
 V_{CE0} : 40 V and 60 V

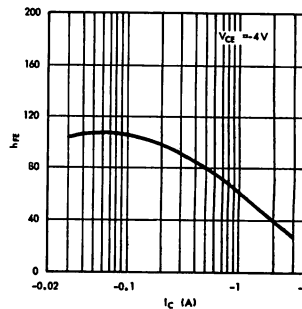

FIGURE 10

SELECTION GUIDE SILICON POWER TRANSISTORS

N-P-N
2N3551-2N3552
40 W
V_{CE0}: 60 V and 80 V

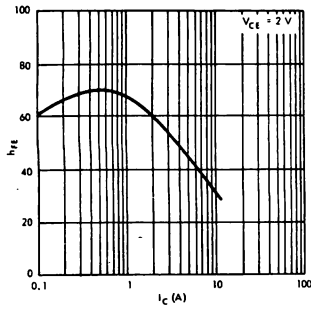

FIGURE 11

N-P-N
2N1724
50 W
V_{CE0}: 80 V

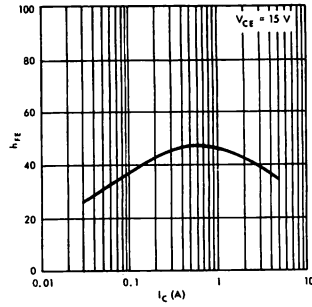

FIGURE 12

N-P-N
2N4301
50 W
V_{CE0}: 80 V

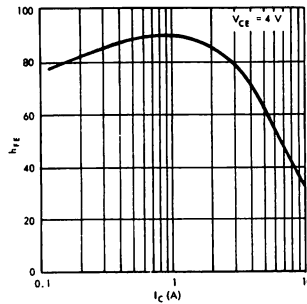

FIGURE 13

N-P-N
TIP33, TIP33A
80 W
V_{CE0}: 40 V and 60 V

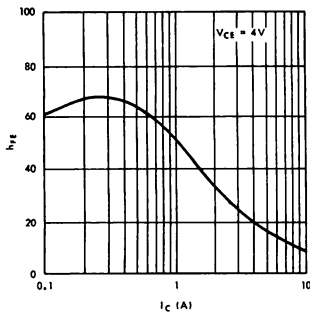

FIGURE 14

P-N-P
TIP34, TIP34A
80 W
V_{CE0}: 40 V and 60 V

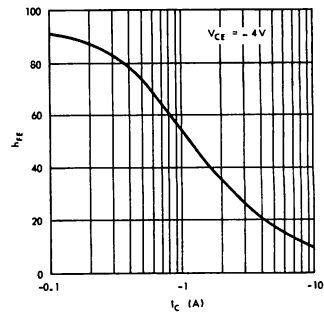

FIGURE 15

SELECTION GUIDE SILICON POWER TRANSISTORS

N-P-N
TIP35, TIP35A
90 W
 V_{CE0} : 40 V and 60 V

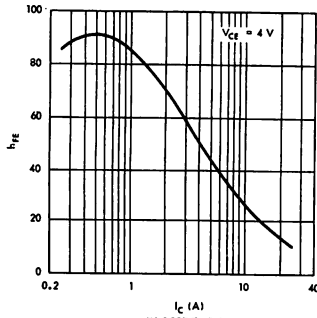

FIGURE 16

P-N-P
TIP36, TIP36A
90 W
 V_{CE0} : 40 V and 60 V

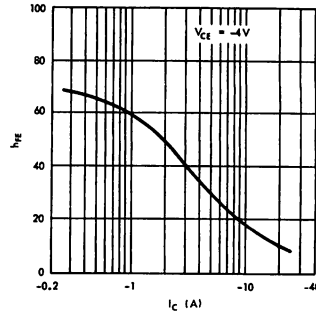

FIGURE 17

N-P-N
2N5387-2N5389
100 W
 V_{CE0} : 200 V, 250 V, and 300 V

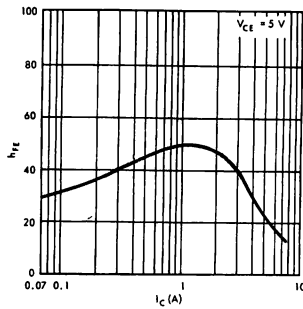

FIGURE 18

N-P-N
2N4002-2N4003
100 W
 V_{CE0} : 80 V and 100 V

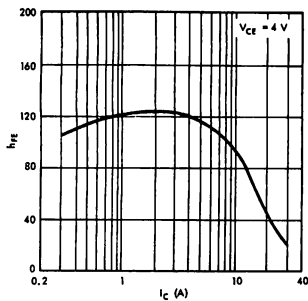

FIGURE 19

N-P-N
2N3713-2N3716
150 W
 V_{CE0} : 60 V and 80 V

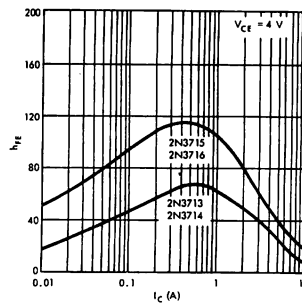

FIGURE 20

CROSS-REFERENCE GUIDE BETWEEN JEDEC OR COMPETITIVE TYPE NUMBERS AND TI DEVICES

Nearest TI types were selected on the basis of the general similarity of electrical characteristics. Interchangeability in particular applications is not guaranteed. Before using a substitute type, the user should compare the detailed specifications of the substitute device with the detailed specifications of the original device with emphasis on those ratings and characteristics which are actually critical. Occasionally another device on the same data sheet as the stated 'Nearest TI Type' may be found to be better suited for the particular application.

TI makes no warranty as to the information furnished and Buyer assumes all risk in the use thereof. No liability is assumed for damages resulting from the use of the information contained in this list.

Type	Preferred TI Type	Nearest TI Type	Type	Preferred TI Type	Nearest TI Type
1N38B	1N484	1N458A	1N315	1N4004	1N4004
1N39B	1N645	1N645	1N316	1N645	1N483A
1N52A	1N483	1N457A	1N317	1N645	1N484A
1N60	1N456	1N456	1N318	1N645	1N485
1N67A	1N484	1N458A	1N319	1N646	1N646
1N69A	1N483	1N457A	1N320	1N648	1N648
1N70A	1N484	1N458A	1N323	1N645	1N645
1N81A	1N483	1N457A	1N324	1N645	1N645
1N90	1N483	1N457A	1N325	1N645	1N645
1N91	1N645	1N484A	1N326	1N646	1N646
1N92	1N645	1N645	1N327	1N648	1N648
1N93	1N646	1N646	1N330	1N456	1N456
1N96	1N483	1N457A	1N331	1N456	1N456
1N98	1N484	1N458A	1N332		1N332
1N98A	1N484	1N458A	1N333		1N333
1N100A	1N484	1N458A	1N334		1N334
1N111	1N914B	1N663	1N335		1N335
1N112	1N914B	1N663	1N336		1N336
1N113	1N914B	1N663	1N337		1N337
1N114	1N914B	1N663	1N338		1N338
1N115	1N914B	1N663	1N339		1N339
1N118A	1N483	1N457A	1N340		1N340
1N119	1N914B	1N663	1N341		1N341
1N120	1N914B	1N663	1N342		1N342
1N126	1N483	1N547A	1N343		1N343
1N127	1N484	1N458A	1N344		1N344
1N128	1N483	1N457A	1N345		1N345
1N128A	1N457	1N457	1N346		1N346
1N137B	1N483	1N457A	1N347		1N347
1N138B	1N483	1N457A	1N348		1N348
1N144	1N914B	1N914B	1N349		1N349
1N145	1N914B	1N658	1N350	1N457	1N457
1N191	1N3070	1N663	1N351	1N484	1N458A
1N193	1N914	1N251	1N352	1N485	1N485
1N194	1N914	1N251	1N353	1N645	1N645
1N194A	1N914	1N251	1N354	1N646	1N646
1N195	1N914	1N251	1N359	1N483	1N457A
1N196	1N914	1N251	1N360	1N484	1N484
1N198	1N484	1N458A	1N361	1N485	1N485
1N198A	1N483	1N457A	1N362	1N646	1N646
1N198B	1N483	1N457A	1N363	1N648	1N648
1N200		1N764	1N417	1N914B	1N663
1N201		1N765	1N418	1N914B	1N663
1N202		1N766	1N419	1N914B	1N663
1N251	1N914	1N251	1N432	1N482	1N457A
1N253		1N253	1N432A	1N482	1N457A
1N254		1N254	1N433	1N485	1N458A
1N256		1N256	1N433A	1N485	1N458A
1N270		TID32	1N434	1N485	1N459A
1N273	1N914B	1N663	1N434A	1N485	1N459A
1N276	1N914B	1N915	1N440	1N4002	1N2069
1N277	1N914B	1N658	1N440B	1N4002	1N440B
1N278	1N914B	1N658	1N441	1N4003	1N2069
1N279	1N914B	1N663	1N441B	1N4003	1N441B
1N281	1N914B	TID29	1N442	1N4004	1N2070
1N282	1N456	1N456	1N442B	1N4004	1N442B
1N283		TID33	1N443	1N4004	1N2070
1N294	1N457	1N457	1N443B	1N4004	1N443B
1N294A	1N483	1N483	1N444	1N4005	1N2071
1N295	1N457	1N457	1N444B	1N4005	1N444B
1N297	1N483	1N458A	1N445	1N4005	1N2071
1N298	1N483	1N457A	1N445B	1N4005	1N445B
1N298A	1N483	1N457A	1N447	1N482	1N461A
1N300	1N482	1N456A	1N448	1N484	1N458A
1N300A	1N482	1N456A	1N449	1N482	1N461A
1N301	1N483	1N457A	1N450	1N484	1N458A
1N301A	1N483	1N457A	1N451	1N484	1N458A
1N301B	1N483	1N457A	1N452	1N482	1N461A
1N302A	1N645	1N645	1N453	1N484	1N458A
*1N302B	1N645	1N645	1N454	1N482	1N461A
1N303	1N484	1N484	1N455	1N482	1N461A
1N303B	1N484	1N484	1N456	1N456	1N456
1N305	1N645	1N483A	1N456A	1N482	1N456A
1N306	1N645	1N482A	1N457	1N457	1N457
1N307	1N484	1N458A	1N457A	1N483	1N457A

*Denotes 1N- or 2N- numbers not JEDEC registered through September 1968.

CROSS-REFERENCE GUIDE BETWEEN JEDEC OR COMPETITIVE TYPE NUMBERS AND TI DEVICES (Cont'd.)

Type	Preferred TI Type	Nearest TI Type	Type	Preferred TI Type	Nearest TI Type
1N458	1N458	1N458	1N606		1N606
1N458A	1N484	1N458A	1N606A	1N648	1N606A
1N459	1N485	1N459	1N607		1N607
1N459A	1N485	1N459A	1N607A	1N4001	1N607A
1N460	1N484	1N458A	1N608		1N608
1N460A	1N484	1N458A	1N608A	1N4002	1N608A
1N461	1N482	1N461	1N609		1N609
1N461A	1N482	1N461A	1N609A	1N4003	1N609A
1N462	1N483	1N462	1N610		1N610
1N462A	1N483	1N483	1N610A	1N4003	1N610A
1N463	1N485	1N463	1N611		1N611
1N463A	1N485	1N485	1N611A	1N4004	1N611A
1N464	1N484	1N464	1N612		1N612
1N464A	1N484	1N484	1N612A	1N4004	1N612A
1N465A	1N4370A	1N702A	1N613		1N613
1N466A	1N747A	650C0	1N613A	1N4005	1N613A
1N467A	1N749A	650	1N614		1N614
1N468A	1N750A	651	1N614A	1N4005	1N614A
1N469A	1N752A	652	1N615	1N4004	1N4004
1N470A	1N754A	653	1N619		1N625
1N471A	1N747A	650C0	1N622	1N3070	1N629
1N472A	1N749A	650	1N625	1N914	1N625
1N473A	1N750A	651	1N626	1N914	1N626
1N474A	1N752A	652	1N627	1N914	1N627
1N475A	1N754A	653	1N628	1N3070	1N628
1N481	1N645	1N645	1N629	1N3070	1N629
1N482	1N482	1N482	1N631	1N914B	1N915
1N482A	1N482	1N482A	1N632	1N914	1N914
1N482B	1N482	1N482B	1N633	1N3070	TID32
1N483	1N483	1N483	1N634	1N3070	1N3070
1N483A	1N483	1N483A	1N635	1N3070	1N3070
1N483B	1N483	1N483B	1N636	1N4448	1N916B
1N484	1N484	1N484	1N643	1N3070	1N643
1N484A	1N484	1N484A	1N643A	1N3070	1N643
1N484B	1N484	1N484B	1N645	1N645	1N645
1N485	1N485	1N485	1N645A	1N645	1N645A
1N485A	1N485	1N485A	1N646	1N646	1N646
1N485B	1N485	1N485B	1N647	1N647	1N647
1N486	1N645	1N645	1N648	1N648	1N648
1N486A	1N645	1N645	1N649	1N649	1N649
1N486B	1N645	1N645	1N658		1N658
1N487	1N646	1N646	1N658A	1N914B	1N658
1N487A	1N646	1N646	1N659		1N659
1N487B	1N646	1N646	1N659A	1N914	1N659
1N488	1N647	1N647	1N660		1N660
1N488A	1N647	1N647	1N660A	1N914B	1N660
1N488B	1N647	1N647	1N661		1N661
1N490	1N914	1N462	1N661A	1N3070	1N661
1N497	1N914B	TID17	1N662	1N914	1N662
1N498	1N914B	TID17	1N663	1N914B	1N663
1N499	1N914B	TID31	1N664	1N756A	1N712
1N500	1N914B	TID32	1N665	1N759	1N716
1N501	1N914B	TID32	1N674	1N750A	1N705A
1N502	1N914B	1N658	1N675	1N753A	1N709A
1N530		1N530	1N676	1N645	1N484A
1N532		1N532	1N677	1N645	1N645
1N533		1N533	1N678	1N645	1N645
1N534		1N534	1N679	1N645	1N645
1N535		1N535	1N681	1N646	1N646
1N536	1N4001	1N536	1N682	1N646	1N646
1N537	1N4002	1N537	1N683	1N647	1N647
1N538	1N4003	1N538	1N684	1N647	1N647
1N539	1N4004	1N539	1N685	1N648	1N648
1N540	1N4004	1N540	1N686	1N648	1N648
1N547	1N4005	1N547	1N687	1N649	1N649
1N548	1N4007	1N4007	1N689	1N649	1N649
1N549	1N4007	1N4007	1N690	1N645	1N645
1N550		1N550	1N691	1N645	1N645
1N551		1N551	1N692	1N645	1N645
1N552		1N552	1N693	1N645	1N645
1N553		1N553	1N695A	1N914B	1N663
1N554		1N554	1N696	1N914	1N914
1N555		1N555	1N699	1N914B	1N663
1N571	1N4001	TID31	1N701	1N758A	1N714A
1N599		1N599	1N702		1N702
1N599A	1N645	1N599A	1N702A	1N4370A	1N702A
1N600		1N600	1N703		1N703
1N600A	1N645	1N600A	1N703A	1N746A	1N703A
1N601		1N601	1N704		1N704
1N601A	1N645	1N601A	1N704A	1N749A	1N704A
1N602		1N602	1N705		1N705
1N602A	1N645	1N602A	1N705A	1N750A	1N705A
1N603		1N603	1N706		1N706
1N603A	1N646	1N603A	1N706A	1N752A	1N706A
1N604		1N604	1N707		1N707
1N604A	1N647	1N604A	1N707A	1N755A	1N707A
1N605		1N605	1N708		1N708
1N605A	1N648	1N605A	1N708A	1N752A	1N708A

CROSS-REFERENCE GUIDE BETWEEN JEDEC OR COMPETITIVE TYPE NUMBERS AND TI DEVICES (Cont'd.)

Type	Preferred TI Type	Nearest TI Type	Type	Preferred TI Type	Nearest TI Type
1N709		1N709	1N818	1N914B	1N916B
1N709A	1N753A	1N709A	1N890	1N914	1N4447
1N710		1N710	1N891	1N914B	1N915
1N710A	1N754A	1N710A	1N892	1N3070	1N658
1N711		1N711	1N897	1N4148	1N660
1N711A	1N755A	1N711A	1N898	1N914B	1N4444
1N712		1N712	1N899	1N914	1N662
1N712A	1N756A	1N712A	1N900	1N914B	1N658
1N713		1N713	1N901	1N914B	1N658
1N713A	1N757A	1N713A	1N902	1N3070	1N643
1N714		1N714	1N903A	1N914B	1N4446
1N714A	1N758A	1N714A	1N904A	1N914B	1N4446
1N715		1N715	1N905A	1N914B	1N4446
1N715A	1N758A	1N715A	1N906A	1N914B	1N4446
1N716		1N716	1N907A	1N914B	1N4446
1N716A	1N759A	1N716A	1N908A	1N914B	1N4446
1N746	1N746	1N746	1N912	1N759A	1N759
1N746A	1N746A	1N746A	1N913	1N759A	1N759
1N747	1N747	1N747	1N914	1N914	1N914
1N747A	1N747A	1N747A	1N914A	1N914B	1N914A
1N748	1N748	1N748	1N914B	1N914B	1N914B
1N748A	1N748A	1N748A	1N915	1N914B	1N915
1N749	1N749	1N749	1N916	1N914	1N916
1N749A	1N749A	1N749A	1N916A	1N914B	1N916A
1N750	1N750	1N750	1N916B	1N914B	1N916B
1N750A	1N750A	1N750A	1N917	1N917	1N917
1N751	1N751	1N751	1N919	1N3070	TID32
1N751A	1N751A	1N751A	1N920	1N645	1N645
1N752	1N752	1N752	1N921	1N645	1N645
1N752A	1N752A	1N752A	1N922	1N645	1N645
1N753	1N753	1N753	1N923	1N645	1N645
1N753A	1N753A	1N753A	1N925	1N914	1N251
1N754	1N754	1N754	1N926	1N914	1N251
1N754A	1N754A	1N754A	1N927	1N914	1N916
1N755	1N755	1N755	1N928	1N3070	1N643
1N755A	1N755A	1N755A	1N929	1N914B	1N4446
1N756	1N756	1N756	1N930	1N914B	1N4446
1N756A	1N756A	1N756A	1N931	1N914B	TID40
1N757	1N757	1N757	1N932	1N914B	TID40
1N757A	1N757A	1N757A	1N934	1N914B	1N916B
1N758	1N758	1N758	1N947	1N649	1N649
1N758A	1N758A	1N758A	1N957		1N957
1N759	1N759	1N759	1N957A		1N957A
1N759A	1N759A	1N759A	1N957B		1N957B
1N761	1N751	1N761	1N958		1N958
1N762	1N752	1N762	1N958A		1N958A
1N763	1N755	1N763	1N958B		1N958B
1N764	1N756	1N764	1N959		1N959
1N765	1N758	1N765	1N959A		1N959A
1N766	1N759	1N766	1N959B		1N959B
1N771	1N914B	TID37	1N960		1N960
1N771A	1N645	TID31	1N960A		1N960A
1N772	1N914B	TID37	1N960B		1N960B
1N772A	1N645	TID31	1N961		1N961
1N773	1N914B	TID37	1N961A		1N961A
1N773A	1N645	TID31	1N961B		1N961B
1N774	1N914B	TID37	1N993	1N914	1N914
1N774A	1N645	TID31	1N994	1N914	1N914
1N775	1N914B	TID37	1N995	1N914	1N914
1N776	1N645	1N915	1N996	1N914B	1N915
1N777	1N914B	TID37	1N997	1N914	1N914
1N778	1N914	1N643	1N999	1N914B	1N914B
1N779	1N3070	1N643	1N1095	1N4005	1N1095
1N781	1N914	TI72	1N1096	1N4005	1N1096
1N789	1N914	TI72	1N1100		1N1100
1N790	1N914	TI72	1N1101		1N1101
1N791	1N914B	TI75	1N1102		1N1102
1N792	1N914B	TID29	1N1103		1N1103
1N793	1N914	1N662	1N1104		1N1104
1N794	1N914	1N662	1N1105		1N1105
1N795	1N914B	1N915	1N1115		1N1115
1N796	1N914B	1N658	1N1116		1N1116
1N797	1N3070	TID42	1N1117		1N1117
1N798	1N3070	TID42	1N1118		1N1118
1N799	1N3070	1N658	1N1119		1N1119
1N800	1N3070	1N658	1N1120		1N1120
1N801	1N3070	TID42	1N1124A		1N1124A
1N802	1N3070	1N3070	1N1125A		1N1125A
1N806	1N914	1N628	1N1126A		1N1126A
1N807	1N3070	1N643	1N1127A		1N1127A
1N808	1N3070	1N663	1N1128A		1N1128A
1N810	1N914	1N4151		1N4004	1N4004
1N811	1N914	1N251		1N4003	1N4003
1N812	1N914	1N251	1N1440		1N4004
1N813	1N914	1N251	1N1441		1N4004
1N814	1N914	1N625	1N1442		1N4004
1N815	1N914B	1N658	1N1487	1N4002	1N1487
1N817	1N3070	1N643	1N1488	1N4003	1N1488

CROSS-REFERENCE GUIDE BETWEEN JEDEC OR COMPETITIVE TYPE NUMBERS AND TI DEVICES (Cont'd.)

Type	Preferred TI Type	Nearest TI Type	Type	Preferred TI Type	Nearest TI Type
1N1489	1N4004	1N1489	1N1831		1N1831
1N1490	1N4004	1N1490	1N1831A		1N1831A
1N1491	1N4005	1N1491	1N1831C		1N1831C
1N1492	1N4005	1N1492	1N1831CA		1N1831CA
1N1581		1N1581	1N1832		1N1832
1N1582		1N1582	1N1832A		1N1832A
1N1583		1N1583	1N1832C		1N1832C
1N1584		1N1584	1N1832CA		1N1832CA
1N1585		1N1585	1N1833		1N1833
1N1586		1N1586	1N1833A		1N1833A
1N1587		1N1587	1N1833C		1N1833C
1N1612		1N1612	1N1833CA		1N1833CA
1N1613		1N1613	1N1834		1N1834
1N1614		1N1614	1N1834A		1N1834A
1N1615		1N1615	1N1834C		1N1834C
1N1616		1N1616	1N1834CA		1N1834CA
1N1692	1N4002	1N1692	1N1835		1N1835
1N1693	1N4003	1N1693	1N1835A		1N1835A
1N1694	1N4004	1N1694	1N1835C		1N1835C
1N1695	1N4004	1N1695	1N1835CA		1N1835CA
1N1696		1N1696	1N1836		1N1836
1N1697		1N1697	1N1836A		1N1836A
1N1701	1N4001	1N4001	1N1836C		1N1836C
1N1702	1N4002	1N4002	1N1836CA		1N1836CA
1N1703	1N4003	1N4003	1N2008		1N2008
1N1704	1N4004	1N4004	1N2008A		1N2008A
1N1705	1N4004	1N4004	1N2008C		1N2008C
1N1706	1N4005	1N4005	1N2008CA		1N2008CA
1N1816		1N1816	1N2009		1N2009
1N1816A		1N1816A	1N2009A		1N2009A
1N1816C		1N1816C	1N2009C		1N2009C
1N1816CA		1N1816CA	1N2009CA		1N2009CA
1N1817		1N1817	1N2010		1N2010
1N1817A		1N1817A	1N2010A		1N2010A
1N1817C		1N1817C	1N2010C		1N2010C
1N1817CA		1N1817CA	1N2010CA		1N2010CA
1N1818		1N1818	1N2011		1N2011
1N1818A		1N1818A	1N2011A		1N2011A
1N1818C		1N1818C	1N2011C		1N2011C
1N1818CA		1N1818CA	1N2011CA		1N2011CA
1N1819		1N1819	1N2012		1N2012
1N1819A		1N1819A	1N2012A		1N2012A
1N1819C		1N1819C	1N2012C		1N2012C
1N1819CA		1N1819CA	1N2012CA		1N2012CA
1N1820		1N1820	1N2069	1N4003	1N2069
1N1820A		1N1820A	1N2069A	1N4003	1N2069A
1N1820C		1N1820C	1N2070	1N4004	1N2070
1N1820CA		1N1820CA	1N2070A	1N4004	1N2070A
1N1821		1N1821	1N2071	1N4005	1N2071
1N1821A		1N1821A	1N2071A	1N4005	1N2071A
1N1821C		1N1821C	1N2072	1N4001	1N4001
1N1821CA		1N1821CA	1N2073	1N4002	1N4002
1N1822		1N1822	1N2074	1N4003	1N4003
1N1822A		1N1822A	1N2075	1N4003	1N4003
1N1822C		1N1822C	1N2076	1N4004	1N4004
1N1822CA		1N1822CA	1N2077	1N4004	1N4004
1N1823		1N1823	1N2078	1N4004	1N4004
1N1823A		1N1823A	1N2079	1N4005	1N4005
1N1823C		1N1823C	1N2080	1N4001	1N4001
1N1823CA		1N1823CA	1N2081	1N4002	1N4002
1N1824		1N1824	1N2082	1N4003	1N4003
1N1824A		1N1824A	1N2083	1N4004	1N4004
1N1824C		1N1824C	1N2084	1N4004	1N4004
1N1824CA		1N1824CA	1N2085	1N4005	1N4005
1N1825		1N1825	1N2086	1N4005	1N4005
1N1825A		1N1825A	1N2088	1N4005	1N4005
1N1825C		1N1825C	1N2089	1N4005	1N4005
1N1825CA		1N1825CA	1N2116	1N4004	1N4004
1N1826		1N1826	1N2117	1N4006	1N4006
1N1826A		1N1826A	1N2175	1N2175	1N2175
1N1826C		1N1826C	1N2372	1N4007	1N4007
1N1826CA		1N1826CA	1N2482	1N4003	1N4003
1N1827		1N1827	1N2483	1N4004	1N4004
1N1827A		1N1827A	1N2484	1N4005	1N4005
1N1827C		1N1827C	1N2485	1N4003	1N4003
1N1827CA		1N1827CA	1N2486	1N4004	1N4004
1N1828		1N1828	1N2487	1N4004	1N4004
1N1828A		1N1828A	1N2488	1N4005	1N4005
1N1828C		1N1828C	1N2489	1N4005	1N4005
1N1828CA		1N1828CA	1N3062	1N914B	1N914B
1N1829		1N1829	1N3063	1N3064	1N3064
1N1829A		1N1829A	1N3064	1N3064	1N3064
1N1829C		1N1829C	1N3065	1N914B	1N914B
1N1829CA		1N1829CA	1N3066	1N3066	1N3066
1N1830		1N1830	1N3067	1N3064	1N3064
1N1830A		1N1830A	1N3068	1N3064	1N3064
1N1830C		1N1830C	1N3069	1N914B	1N914B
1N1830CA		1N1830CA	1N3070	1N3070	1N3070

CROSS-REFERENCE GUIDE BETWEEN JEDEC OR COMPETITIVE TYPE NUMBERS AND TI DEVICES (Cont'd.)

Type	Preferred TI Type	Nearest TI Type	Type	Preferred TI Type	Nearest TI Type
1N3071	1N3070	1N3070	1N4362	1N645	1N484A
1N3146	1N914B	1N4444	1N4370	1N4370	1N4370
1N3179	1N4003	1N4003	1N4370A	1N4370A	1N4370A
1N3192	1N645	1N645	1N4371	1N4371	1N4371
1N3215	1N914	1N914	1N4371A	1N4371A	1N4371A
1N3223	1N3070	1N3070	1N4372	1N4372	1N4372
1N3477	1N4370	1N702	1N4372A	1N4372A	1N4372A
1N3477A	1N4372A	1N702A	1N4373	1N914	1N4373
1N3478	1N645	1N645	1N4375	1N914B	1N4446
1N3479	1N647	1N647	1N4378	LS400	LS400
1N3480	1N649	1N649	1N4444	1N914B	1N4444
1N3485	1N3070	1N643	1N4446	1N4448	1N4446
1N3506		1N3506	1N4447	1N4448	1N4447
1N3507		1N3507	1N4448	1N4448	1N4448
1N3508		1N3508	1N4449	1N4448	1N4449
1N3509		1N3509	1N4450	1N914B	1N4444
1N3510		1N3510	1N4451	1N914B	1N4444
1N3511		1N3511	1N4453	1N4448	1N4448
1N3512		1N3512	1N4454	1N4454	1N4454
1N3513		1N3513	1N4523	1N4448	1N4448
1N3514		1N3514	1N4531	1N4531	1N4531
1N3515		1N3515	1N4532	1N4531	1N4532
1N3516		1N3516	1N4533	1N4531	1N4533
1N3517		1N3517	1N4534	1N4531	1N4534
1N3518		1N3518	1N4536	1N4531	1N4536
1N3519		1N3519	1N4541	1N645	1N645
1N3520		1N3520	1N4542	1N647	1N647
1N3535	1N645	1N645	1N4543	1N649	1N649
1N3536	1N457	1N457	1N4544	1N649	1N649
1N3550	1N3070	1N3070	1N4545	1N649	1N649
1N3568	1N914B	1N4446	1N4548	1N649	1N649
1N3593	1N4531	1N4531	1N4606	1N914B	1N4448
1N3594	1N4531	1N4531	1N4718	1N4001	1N4001
1N3596	1N3070	1N3070	1N4726	1N4148	1N4148
1N3598	1N914	1N914	1N4727	1N4148	1N4727
1N3599	1N3070	1N3070	1N4827	1N914	1N915
1N3601	1N3070	1N3070	1N4828	1N914B	1N914B
1N3602	1N3070	1N3070	1N4861	1N483	1N483
1N3603	1N3070	1N3070	1N4862	1N483	1N483
1N3604	1N914B	1N914B	1N4863	1N914B	1N914B
1N3607	1N914B	1N914B	1N4938	1N3070	1N4938
1N3656	1N4003	1N4003	2N34	2N404	2N404
1N3657	1N4004	1N4004	2N34A	2N404	2N404
1N3658	1N4005	1N4005	2N35	2N404	2N404
1N3668	1N914	1N914	2N36	2N404	2N404
1N3722	1N914B	1N4446	2N37	2N404	2N404
1N3728	1N649	1N649	2N38	2N404	2N404
1N3731	1N914B	1N914B	2N41	2N404	2N404
1N3753	1N645	1N483A	2N42	2N404	2N404
1N3866	1N4003	1N4003	2N45	2N404	2N404
1N3867	1N4004	1N4004	2N46	2N404	2N404
1N3868	1N4005	1N4005	2N47	2N404	2N404
1N3873	1N914B	1N914B	2N48	2N404	2N404
1N3894	1N648	1N648	2N49	2N404	2N404
1N3895	1N648	1N648	2N50	2N404	2N404
1N3956	1N914B	1N4534	2N51	2N404	2N404
1N4001	1N4001	1N4001	2N52	2N404	2N404
1N4002	1N4002	1N4002	2N53	2N404	2N404
1N4003	1N4003	1N4003	2N54	2N404	2N404
1N4004	1N4004	1N4004	2N55	2N404	2N404
1N4005	1N4005	1N4005	2N56	2N404	2N404
1N4006	1N4006	1N4006	2N57	TI3027	TI3027
1N4007	1N4007	1N4007	2N59	2N404	2N404
1N4043	1N914B	1N914B	2N60	2N404	2N404
1N4087	1N914B	1N914B	2N61	2N404	2N404
1N4099		1N4099	2N62	2N404	2N404
1N4100		1N4100	2N63	2N404	2N404
1N4101		1N4101	2N64	2N404	2N404
1N4102		1N4102	2N65	2N404	2N404
1N4103		1N4103	2N66	TI3027	TI3027
1N4104		1N4104	2N68	TI3027	TI3027
1N4105		1N4105	2N71	2N404	2N404
1N4106		1N4106	2N73	2N404	2N404
1N4147	1N914B	1N914B	2N74	2N404	2N404
1N4148	1N4148	1N4148	2N75	2N404	2N404
1N4149	1N4148	1N4149	2N76	2N404	2N404
1N4150	1N914B	1N4444	2N77	2N404	2N404
1N4151	1N4448	1N4151	2N78	2N1302	2N1302
1N4152	1N4448	1N4152	2N78A	2N1302	2N1302
1N4153	1N4448	1N4153	2N79	2N404	2N404
1N4154	1N4448	1N4154	2N80	2N404	2N404
1N4244	1N914B	1N4446	2N81	2N404	2N404
1N4305	1N4148	1N4305	2N82	2N404	2N404
1N4360	1N4370	1N4360			

CROSS-REFERENCE GUIDE BETWEEN JEDEC OR COMPETITIVE TYPE NUMBERS AND TI DEVICES (Cont'd.)

Type	Preferred TI Type	Nearest TI Type	Type	Preferred TI Type	Nearest TI Type
2N94	2N1304	2N1304	*2N204	2N1377	2N1373
2N96	2N404	2N404	*2N205	2N1377	2N1372
2N97	2N1302	2N1302	2N206	2N1377	2N1372
2N98	2N1304	2N1304	2N207	2N1377	2N1372
2N99	2N1306	2N1306	2N211	2N1302	2N1302
2N100	2N1306	2N1306	2N212	2N1302	2N1302
2N101	2N404	2N404	2N213	2N1304	2N1304
2N102	2N1302	2N1302	2N214	2N1304	2N1304
2N103	2N1302	2N1302	2N215	2N404	2N404
2N104	2N404	2N404	2N216	2N1302	2N1302
2N105	2N404	2N404	2N217	2N404	2N404
2N106	2N404	2N404	2N218	2N404	2N404
2N107	2N404	2N404	2N219	2N404	2N404
2N108	2N404	2N404	2N220	2N404	2N404
2N109	2N404	2N404	2N223	2N404	2N404
2N111	2N404	2N404	2N224	2N404	2N404
2N112	2N404	2N404	2N225	2N404	2N404
2N115	2N404	2N404	2N226	2N404	2N404
2N116	2N404	2N404	2N227	2N404	2N404
2N117		2N117	2N228	2N1302	2N1302
2N118		2N118	2N229	2N1302	2N1302
2N118A		2N118A	2N231	2N404	2N404
2N119		2N119	2N232	2N404	2N404
2N120		2N120	2N233	2N1306	2N1306
2N122		2N122	2N234	TI3027	TI3027
2N123	2N1303	2N1303	2N234A	TI3027	TI3027
2N124	2N1302	2N1302	2N235	TI3027	TI3027
2N125	2N1304	2N1304	2N235A	TI3027	TI3027
2N126	2N1304	2N1304	2N235B	TI3027	TI3027
2N127	2N1304	2N1304	2N236	TI3027	TI3027
2N128	2N404	2N404	2N236A	TI3027	TI3028
2N129	2N404	2N404	2N236B	TI3027	TI3028
2N130	2N404	2N404	2N237	2N404	2N404
2N131	2N404	2N404	2N238	2N404	2N404
2N132	2N404	2N404	2N240	2N404	2N404
2N133	2N404	2N404	2N241	2N404	2N404
2N135	2N404	2N404	2N242	TI3027	TI3029
2N136	2N404	2N404	2N243		2N243
2N137	2N404	2N404	2N244		2N244
2N138	2N404	2N404	2N247		2N2188
2N139	2N404	2N404	2N248		2N2188
2N140	2N404	2N404	2N249	2N404	2N404
2N141	2N1038	2N1038	2N250	2N456A	2N250
2N143	2N1038	2N1038	2N250A	2N456A	2N250A
2N145	2N1302	2N1302	2N251	2N456A	2N251
2N146	2N1302	2N1302	2N251A	2N456A	2N251A
2N147	2N1302	2N1302	2N252		2N2188
2N148	2N1302	2N1302	2N253	2N1302	2N1302
2N149	2N1302	2N1302	2N254	2N1302	2N1302
2N150	2N1302	2N1302	2N255	TI3027	TI3027
2N155	TI3027	TI3027	2N255A	TI3027	TI3027
2N156	TI3027	TI156	2N256	TI3027	TI3027
2N157	2N1038	2N1038	2N256A	TI3027	TI3027
2N158	TI3027	TI158	2N257	TI3027	TI3027
2N158A	TI3027	TI158A	*2N257B	TI3027	TI3027
*2N164	2N1302	2N1302	2N263		2N263
*2N165	2N1302	2N1302	2N264		2N264
2N166	2N1304	2N1304	2N265	2N404	2N404
2N167	2N1306	2N1306	2N266	2N404	2N404
2N168	2N1306	2N1306	2N267		2N2188
2N169	2N1308	2N1308	2N268	TI3027	TI3027
2N170	2N1308	2N1308	2N268A	TI3027	TI3030
2N173	TI3027	TI3027	2N269	2N1303	2N1303
2N174	TI3027	TI3027	2N270	2N404	2N404
2N174A	TI3027	TI3027	2N271	2N404	2N404
2N175	2N404	2N404	2N272	2N404	2N404
2N176	TI3027	TI3027	2N273	2N404	2N404
2N178	TI3027	TI3027	2N274		2N2188
2N179	TI3027	TI3027	2N279	2N404	2N404
2N180	2N404	2N404	2N280	2N404	2N404
2N181	2N404	2N404	2N281	2N404	2N404
2N182	2N1302	2N1302	2N282	2N404	2N404
2N183	2N1302	2N1302	2N283	2N404	2N404
2N184	2N1306	2N1306	2N284	2N404	2N404
2N185	2N404	2N404	2N285	TI3027	TI3027
2N186	2N404	2N404	2N285A	TI3027	TI3027
2N186A	2N404	2N404	*2N285B	TI3027	TI3027
2N193	2N1302	2N1302	2N291	2N404	2N404
2N194	2N1302	2N1302	2N292	2N1302	2N1302
			2N293	2N1304	2N1304

*Denotes 1N- or 2N- numbers not JEDEC registered through September 1968.

CROSS-REFERENCE GUIDE BETWEEN JEDEC OR COMPETITIVE TYPE NUMBERS AND TI DEVICES (Cont'd.)

Type	Preferred TI Type	Nearest TI Type	Type	Preferred TI Type	Nearest TI Type
2N296	2N456A	2N3146	2N388	2N1306	2N388
2N297	T13027	T13028	2N388A	2N1306	2N388A
2N297A		T13028	2N389		2N389
2N299		2N2188	2N389A		2N389A
2N300		2N2188	2N392	T13027	T13027
2N301	T13027	T13027	2N393		2N2189
2N301A	T13027	T13028	2N394	2N404	2N404
2N302	2N1303	2N1303	2N395	2N1308	2N395
2N303	2N1303	2N1303	2N396	2N1305	2N396
2N306	2N1302	2N1302	2N396A	2N1307	2N397
2N307	T13027	T13027	2N397	2N1307	2N397
2N307A	T13027	T13027	2N398	2N398	2N398
2N308	2N1377	2N1375	2N398A	2N398	2N398A
2N309	2N1377	2N1375	2N398B	2N398	2N398B
2N310	2N1377	2N1375	2N399	T13027	T13028
2N311	2N404	2N404	2N400	T13027	T13028
2N312	2N1304	2N1304	2N401	T13027	T13028
2N315		2N315A	2N402	2N404	2N404
2N315A		2N315A	2N403	2N404	2N404
2N316	2N404	2N404	2N404	2N404	2N404
2N317		2N317A	2N404A	2N404	2N404A
2N317A		2N317A	2N405	2N404	2N404
2N325	T13027	T13027	2N406	2N404	2N404
2N326	T13027	T13027	2N407	2N404	2N404
2N327A		2N327A	2N408	2N404	2N404
2N328A		2N328A	2N409	2N404	2N404
2N329A		2N329A	2N410	2N404	2N404
2N331	2N404	2N404	2N411	2N404	2N404
2N332	2N404	2N332	2N412	2N404	2N404
2N332A		2N332A	2N413	2N404	2N404
2N333		2N333	2N414	2N404	2N404
2N333A		2N333A	2N415	2N404	2N404
2N334		2N334	2N416	2N404	2N404
2N334A		2N334A	2N417	2N404	2N404
2N335		2N335	2N418	2N456A	2N3146
2N335A		2N335A	2N419	T13027	T13029
2N336		2N336	2N420	T13027	T13029
2N336A		2N336A	2N420A	2N456A	2N3146
2N337		2N337	2N424		2N424
2N338		2N338	2N424A		2N424A
2N339		2N339	2N425	2N404	2N404
2N340		2N340	2N426	2N404	2N426
2N341		2N341	2N427	2N404	2N427
2N342		2N342	2N428	2N404	2N428
2N342A		2N342A	2N428A	2N404	2N428
2N343		2N343	2N438	2N1304	2N438
2N344	2N404	2N404	2N438A	2N1304	2N438A
2N345	2N404	2N404	2N439	2N1304	2N439
2N346	2N404	2N404	2N439A	2N1304	2N439
2N350	T13027	T13028	2N440	2N1304	2N440
2N351	T13027	T13028	2N444	2N1304	2N1304
2N351A	T13027	T13028	2N444A	2N1304	2N1304
2N352	T13027	T13027	2N445	2N1304	2N1304
2N353	T13027	T13027	2N445A	2N1304	2N1304
2N356	2N1302	2N1302	2N446A	2N1304	2N1304
2N356A	2N1302	2N1302	2N447A	2N1304	2N1304
2N357	2N1302	2N1302	2N448	2N1307	2N1307
2N357A	2N1302	2N1302	2N449	2N1306	2N1306
2N358	2N1304	2N1304	2N450	2N1302	2N1302
2N358A	2N1304	2N1304	2N456	2N456A	2N456A
2N359	2N404	2N404	2N456A	2N456A	2N456A
2N360	2N404	2N404	2N456B	2N456A	2N456B
2N361	2N404	2N404	2N457	2N456A	2N457A
2N362	2N404	2N404	2N457A	2N456A	2N457A
2N363	2N404	2N404	2N457B	2N456A	2N457B
2N364	2N1306	2N1306	2N458	2N456A	2N458A
2N365	2N1306	2N1306	2N458A	2N456A	2N458A
2N366	2N1306	2N1306	2N458B	2N456A	2N458B
2N367	2N404	2N404	2N459	2N456A	2N3146
2N370	2N404	2N404	2N459A	T13027	T13031
2N371		2N2188	2N462		2N1319
2N372		2N2188	2N464	2N404	2N404
2N373		2N2188	2N465	2N404	2N404
2N374		2N2188	2N466	2N404	2N404
2N375	T13027	2N2188	2N467	2N404	2N404
2N376	T13027	T13031	2N470		2N470
2N377	2N1302	T13028	2N471		2N471
2N377A	2N1302	2N377	2N472		2N472
2N378	T13027	2N377	2N473		2N473
2N379	T13027	2N377	2N474		2N474
2N380	T13027	T13027	2N475		2N475
2N384		T13030	2N476		2N476
2N385	2N1304	2N2189	2N477		2N477
2N385A	2N1304	2N1304	2N478		2N478
2N386	T13027	2N1304	2N479		2N479
2N387	T13027	T13027	2N480		2N480
		T13027	2N481		2N2188

CROSS-REFERENCE GUIDE BETWEEN JEDEC OR COMPETITIVE TYPE NUMBERS AND TI DEVICES (Cont'd.)

Type	Preferred TI Type	Nearest TI Type	Type	Preferred TI Type	Nearest TI Type
2N482		2N2189	2N555	T13027	T13027
2N483		2N2189	2N556	2N1302	2N1302
2N484		2N2189	2N557	2N1304	2N1304
2N485		2N2190	2N558	2N1306	2N1306
2N486		2N2191	2N560	2N5015	2N2537
2N487		2N2191	2N561	2N456A	2N3146
2N489	2N491A	2N489	2N574	2N456A	2N1022A
2N489A	2N491A	2N489A	2N574A	2N456A	2N3146
2N489B	2N491A	2N489B	2N576	2N1304	2N1304
2N490	2N491A	2N490	2N578	2N404	2N404
2N490A	2N491A	2N490A	2N579	2N404	2N404
2N490B	2N491A	2N490B	2N580	2N404	2N404
2N491	2N491A	2N491	2N581	2N404	2N581
2N491A	2N491A	2N491A	2N582	2N404	2N582
2N491B	2N491A	2N491B	2N583	2N404	2N404
2N492	2N491A	2N492	2N584	2N404	2N404
2N492A	2N491A	2N492A	2N585	2N1304	2N1304
2N492B	2N491A	2N492B	2N586	2N404	2N404
2N492C	2N491A	2N492B	2N587	2N1304	2N587
2N493	2N491A	2N493	2N588		2N2189
2N493A	2N491A	2N493A	2N591	2N404	2N404
2N493B	2N491A	2N493B	2N594		2N594
2N494	2N491A	2N494	2N595		2N595
2N494A	2N491A	2N494A	2N596		2N596
2N494B	2N491A	2N494B	2N597	2N1997	2N1997
2N494C	2N491A	2N494C	2N598	2N1997	2N1998
2N495	2N2945A	2N2944	2N599	2N1997	2N1999
2N496	2N2945A	2N2944	2N600	2N1997	2N1998
2N497		2N497	2N601	2N1997	2N1999
2N497A		2N497A	2N602	2N2635	2N2635
2N498		2N498	2N603	2N2635	2N2635
2N498A		2N498A	2N604	2N2635	2N2635
2N499		2N2188	2N605	2N2635	2N2635
2N500		2N2189	2N606	2N2635	2N2635
2N501		2N2189	2N607	2N2635	2N2635
2N502		2N2189	2N608	2N2635	2N2635
2N503		2N2189	2N609	2N404	2N404
2N504		2N2189	2N610	2N404	2N404
2N508		2N508	2N611	2N404	2N404
2N511	2N456A	2N511	2N612	2N404	2N404
2N511A	2N456A	2N511A	2N613	2N404	2N404
2N511B	2N456A	2N511B	2N614	2N404	2N404
2N512	2N456A	2N512	2N615	2N404	2N404
2N512A	2N456A	2N512A	2N617	2N404	2N404
2N512B	2N456A	2N512B	2N618	T13027	T13030
2N513	2N456A	2N513	2N622	2N2432	2N2432
2N513A	2N456A	2N513A	2N624		2N2188
2N513B	2N456A	2N513B	2N625	2N1308	2N1308
2N514	2N456A	2N514	2N627	T13027	T13027
2N514A	2N456A	2N514A	2N628	T13027	T13028
2N514B	2N456A	2N514B	2N629	T13027	T13030
2N515		2N1304	2N630	T13027	T13031
2N516		2N1304	2N631	2N404	2N404
2N517	2N1306	2N1306	2N632	2N404	2N404
2N518	2N404	2N404	2N633	2N404	2N404
2N519	2N404	2N404	2N634	2N1304	2N634A
2N520	2N404	2N520	2N634A	2N1304	2N634A
2N520A	2N404	2N520A	2N635	2N1304	2N635A
2N521	2N1377	2N1377	2N635A	2N1304	2N635A
2N522		2N522A	2N636	2N1304	2N636A
2N522A		2N522A	2N636A	2N1304	2N636A
2N523	2N1377	2N1377	2N637	T13027	T13027
2N524		2N524	2N637A	T13027	T13031
2N525		2N525	2N637B	2N456A	2N3146
2N526		2N526	2N638	T13027	T13027
2N527		2N527	2N638A	T13027	T13028
2N534	2N404	2N404	2N638B	2N456A	2N3146
2N535	2N404	2N404	2N639	T13027	T13028
2N536	2N404	2N404	2N639A	2N456A	2N3146
2N538	T13027	T13031	2N639B	2N456A	2N3146
2N538A	T13027	T13031	2N640		2N2188
2N539	T13027	T13031	2N641		2N2188
2N539A	T13027	T13031	2N642		2N2188
2N540	T13027	T13031	2N643	2N2635	2N2635
2N540A	T13027	T13031	2N644	2N2635	2N2635
2N541		2N541	2N645	2N2635	2N2635
2N541A		2N541	2N647	2N1306	2N1306
2N542		2N542	2N649	2N1308	2N1308
2N542A		2N542	2N650	2N1997	2N650A
2N543		2N543	2N650A	2N1997	2N650A
2N543A		2N543	2N651	2N1997	2N651A
2N544		2N2188	2N651A	2N1997	2N651A
2N549	2N1893	2N1893	2N652	2N1997	2N652A
2N550	2N1893	2N1893	2N652A	2N1997	2N652A
2N551	2N1893	2N1893	2N653	2N1997	2N1997
2N552	2N1893	2N1893	2N654	2N1997	2N1997
2N554	T13027	T13027	2N655	2N1997	2N1997
			2N656		2N656

CROSS-REFERENCE GUIDE BETWEEN JEDEC OR COMPETITIVE TYPE NUMBERS AND TI DEVICES (Cont'd.)

Type	Preferred TI Type	Nearest TI Type	Type	Preferred TI Type	Nearest TI Type
2N656A		2N656A	2N727		2N727
2N657		2N657	2N728		2N2217
2N657A		2N657A	2N729		2N2217
2N658	2N2000	2N658	2N730	2N2219	2N730
2N659	2N2000	2N659	2N731	2N218A	2N731
2N660	2N2000	2N660	2N734	2N718A	2N734
2N661	2N2000	2N661	2N735		2N735
2N662	2N2000	2N662	2N735A		2N735
2N663	T13027	T13027	2N736		2N736
2N665	T13027	T13028	2N736A		2N736A
2N669	T13027	T13027	2N736B		2N736A
2N670	2N1038	2N1038	2N738		2N738
2N671	2N1038	2N1038	2N739		2N739
2N672	2N1038	2N1038	2N739A		2N739
2N673	2N1038	2N1038	2N740		2N740
2N674	2N1038	2N1038	2N740A		2N740
2N677	2N456A	2N456A	2N741	2N5043	2N2996
2N677A	2N456A	2N456B	2N741A	2N5043	2N2997
2N677B	2N456A	2N3146	2N742	2N2219	2N2217
2N677C	2N456A	2N3146	2N742A	2N2219	2N2217
2N678	2N456A	2N513	2N743		2N743
2N678A	2N456A	2N513	2N743A		2N743
2N678B	2N456A	2N513A	2N744		2N744
2N678C	2N456A	2N513B	2N744A		2N744
2N679	2N1304	2N1304	2N745		2N337
2N680	2N404	2N404	2N746		2N338
2N681		2N681	2N747		2N337
2N681A		2N681A	2N748		2N337
2N682		2N682	2N749	2N697	2N696
2N682A		2N682A	2N751	2N697	2N697
2N683		2N683	2N752		2N736
2N683A		2N683A	2N753		2N753
2N684		2N684	2N754	2N1893	2N1893
2N684A		2N684A	2N755	2N1893	2N1893
2N685		2N685	2N756		2N734
2N685A		2N685A	2N757		2N734
2N686		2N686	2N757A		2N734
2N686A		2N686A	2N758		2N734
2N687		2N687	2N758A		2N734
2N687A		2N687A	2N758B		2N734
2N688		2N688	2N759		2N759
2N688A		2N688A	2N759A		2N759A
2N689		2N689	2N759B		2N759A
2N689A		2N689A	2N760		2N760
2N694	2N2635	2N2635	2N760A		2N760A
2N695	2N2635	2N2635	2N760B		2N760A
2N696	2N697	2N696	2N768	2N964	2N961
2N697	2N697	2N697	2N769	2N964	2N964
2N698	2N1893	2N698	2N773		2N734
2N699	2N1893	2N699	2N774		2N734
2N699A	2N1893	2N699	2N775		2N735
2N699B	2N1893	2N699	2N776		2N734
2N700	2N5043	2N2415	2N777		2N734
2N700A	2N5043	2N2415	2N778		2N735
2N702		2N702	2N779	2N964	2N964
2N703		2N703	2N779A	2N964	2N964
2N705	2N964	2N705	2N780		2N780
2N705A	2N964	2N705	2N781	2N2635	2N2635
2N706		2N706	2N782	2N2635	2N2635
2N706A		2N706A	2N783	2N3010	2N3010
2N706B		2N706B	2N784	2N3010	2N3010
2N706C		2N706B	2N784A	2N3010	2N3010
2N707	2N2484	2N2483	2N789		2N332
2N707A	2N2484	2N2484	2N790		2N333
2N708		2N708	2N791		2N334
2N708A		2N708	2N792		2N335
2N709	2N3010	2N709	2N793		2N336
2N709A	2N3010	2N709	2N794	2N2635	2N2635
2N710	2N964	2N710	2N795	2N2635	2N2635
2N710A	2N964	2N710	2N796	2N2635	2N2635
2N711	2N964	2N711	2N797	2N797	2N797
2N711A	2N964	2N711A	2N799	2N1309	2N1309
2N711B	2N964	2N711B	2N800	2N404	2N404
2N715	2N4875	2N4875	2N801	2N404	2N404
2N716	2N4875	2N4875	2N802	2N404	2N404
2N717	2N718A	2N717	2N803	2N404	2N404
2N718	2N718A	2N718	2N804	2N404	2N404
2N718A	2N718A	2N718A	2N805	2N404	2N404
2N719	2N720A	2N719	2N806	2N404	2N404
2N719A	2N720A	2N719A	2N807	2N404	2N404
2N720	2N720A	2N720	2N808	2N404	2N404
2N720A	2N720A	2N720A	2N809	2N404	2N404
2N721	2N2907	2N721	2N810	2N404	2N404
2N721A	2N2907	2N721	2N812	2N404	2N404
2N722	2N2907	2N722	2N813	2N404	2N404
2N722A	2N2907	2N722	2N814	2N404	2N404
2N725	2N2635	2N2635	2N815	2N404	2N404
2N726		2N726	2N816	2N404	2N404

CROSS-REFERENCE GUIDE BETWEEN JEDEC OR COMPETITIVE TYPE NUMBERS AND TI DEVICES (Cont'd.)

Type	Preferred TI Type	Nearest TI Type	Type	Preferred TI Type	Nearest TI Type
2N817	2N404	2N404	2N934	2N2635	2N2635
2N818	2N404	2N404	2N935	2N2945A	2N2944
2N819	2N404	2N404	2N936	2N2945A	2N2944
2N820	2N404	2N404	2N937	2N2945A	2N2944
2N821	2N404	2N404	2N938	2N2945A	2N2944
2N822	2N404	2N404	2N939	2N2945A	2N2944
2N823	2N404	2N404	2N940	2N2945A	2N2944
2N824	2N404	2N404	2N941	2N2945A	2N2944
2N825	2N404	2N404	2N942	2N2945A	2N2944
2N826	2N404	2N404	2N943	2N2945A	2N2944
2N834		2N3014	2N944	2N2945A	2N2944
2N834A		2N3014	2N945	2N2945A	2N2944
2N835		2N3014	2N946	2N2945A	2N2944
2N838	2N2635	2N2635	2N947		2N706
2N839	2N930	2N929	2N955	2N797	2N797
2N840	2N930	2N929	2N955A	2N797	2N797
2N841	2N930	2N929	2N956	2N718A	2N956
2N842	2N4252	2N4253	2N957	2N2484	2N2484
2N843	2N4252	2N4253	2N958		2N706
2N844	2N1893	2N1893	2N959		2N706
2N845	2N1893	2N1893	2N960	2N964	2N960
2N846	2N964	2N964	2N961	2N964	2N961
2N846A	2N964	2N964	2N962	2N964	2N962
2N846B	2N964	2N964	2N963	2N964	2N963
2N849		2N849	2N964	2N964	2N964
2N850		2N850	2N964A	2N964	2N964A
2N851		2N851	2N965	2N964	2N965
2N852		2N852	2N966	2N964	2N966
2N858	2N2945A	2N2945	2N967	2N964	2N967
2N859	2N2945A	2N2945	2N968	2N964	2N968
2N860	2N2945A	2N2945	2N969	2N964	2N969
2N861	2N2945A	2N2944	2N970	2N964	2N970
2N862	2N2945A	2N2944	2N971	2N964	2N971
2N863	2N2945A	2N2944	2N972	2N964	2N972
2N864	2N2905	2N2904	2N973	2N964	2N973
2N864A	2N2905	2N2904	2N974	2N964	2N974
2N865	2N2905	2N2904	2N975	2N964	2N975
2N865A	2N2905	2N2904	2N976	2N964	2N961
2N869	2N2905	2N2904	2N977	2N964	2N985
2N869A	2N2894	2N3576	2N978	2N2907	2N721
2N870	2N720A	2N870	2N979	2N2635	2N2635
2N871	2N720A	2N871	2N980	2N2635	2N2635
2N876		2N876	2N982	2N964	2N985
2N877		2N877	2N983	2N964	2N985
2N878		2N878	2N984	2N964	2N985
2N879		2N879	2N985	2N964	2N985
2N880		2N880	2N986	LS600	LS600
2N881		2N881	2N987	2N2635	2N2635
2N884		2N884	2N988		2N706
2N885		2N885	2N989		2N706
2N886		2N886	2N990	2N2635	2N2635
2N887		2N887	2N991	2N2635	2N2635
2N888		2N888	2N992	2N2635	2N2635
2N889		2N889	2N993	2N2635	2N2635
2N902		2N332	2N995		2N995
2N903		2N333	2N995A		2N995
2N904		2N334	2N996	2N2907	2N2906
2N905		2N335	2N997	2N997	2N997
2N906		2N336	2N998	2N997	2N997
2N907	2N3015	2N2537	2N999	2N997	2N997
2N908	2N3015	2N2537	2N1000	2N404	2N404A
2N909	2N2243A	2N2192	2N1010	2N1302	2N1302
2N910	2N720A	2N910	2N1011	TI3027	TI3028
2N911	2N720A	2N911	2N1012	2N1306	2N388A
2N912	2N720A	2N912	2N1014	2N456A	2N1021
2N914		2N914	2N1017	2N404	2N582
2N914A		2N914	2N1018	2N404	2N582
2N915		2N915	2N1021	2N456A	2N1021
2N915A		2N915	2N1021A	2N456A	2N1021A
2N916		2N916	2N1022	2N456A	2N1022
2N916A		2N916	2N1022A	2N456A	2N1022A
2N916B		2N916	2N1023	2N2635	2N2635
2N917	2N918	2N917	2N1024	2N2945A	2N2944
2N917A	2N918	2N917	2N1025	2N2945A	2N2944
2N918	2N918	2N918	2N1026	2N2945A	2N2944
2N919		2N706	2N1027	2N2945A	2N2944
2N920		2N706	2N1028	2N2945A	2N2944
2N923	2N2605	2N2604	2N1029	TI3027	TI3027
2N924	2N2605	2N2604	2N1029A	TI3027	TI3027
2N925	2N2605	2N2604	2N1029B	TI3027	TI3031
2N926	2N2605	2N2604	2N1029C	2N456A	2N3146
2N927	2N2605	2N2604	2N1030	2N456A	2N514A
2N928	2N2605	2N2604	2N1030A	2N456A	2N514B
2N929	2N930	2N929	2N1031	TI3027	TI3027
2N929A	2N930	2N929A	2N1031A	TI3027	TI3027
2N930	2N930	2N930	2N1031B	TI3027	TI3031
2N930A	2N930	2N930A	2N1031C	2N456A	2N3146
2N930B	2N930	2N930A	2N1032	2N456A	2N514A

CROSS-REFERENCE GUIDE BETWEEN JEDEC OR COMPETITIVE TYPE NUMBERS AND TI DEVICES (Cont'd.)

Type	Preferred TI Type	Nearest TI Type	Type	Preferred TI Type	Nearest TI Type
2N1032A	2N456A	2N514B	2N1130	2N1377	2N1375
2N1034	2N2945A	2N2944	2N1131	2N2905	2N1131
2N1035	2N2945A	2N2944	2N1131A	2N2905	2N1131
2N1036	2N2945A	2N2944	2N1132	2N2905	2N1132
2N1037	2N2945A	2N2944	2N1132B	2N2905	2N1132
2N1038	2N1038	2N1038	2N1136	TI3027	TI3027
2N1038-1	2N1038	2N2552	2N1136A	TI3027	TI3028
2N1038-2	2N1038	2N2556	2N1136B	2N456A	2N3146
2N1039	2N1038	2N1039	2N1137	2N456A	2N456A
2N1039-1	2N1038	2N2553	2N1137A	2N456A	2N1022A
2N1039-2	2N1038	2N2557	2N1137B	2N456A	2N3146
2N1040	2N1038	2N1040	2N1138	TI3027	TI3029
2N1040-1	2N1038	2N2554	2N1138A	2N456A	2N3146
2N1040-2	2N1038	2N2558	2N1138B	2N456A	2N3146
2N1041	2N1038	2N1041	2N1141		2N1141
2N1041-1	2N1038	2N2555	2N1141A		2N1141A
2N1041-2	2N1038	2N2559	2N1142		2N1142
2N1042	2N1038	2N1042	2N1142A		2N1142A
2N1042-1	2N1038	2N2560	2N1143		2N1143
2N1042-2	2N1038	2N2564	2N1143A		2N1143A
2N1043	2N1038	2N1043	2N1144	2N1303	2N1303
2N1043-1	2N1038	2N2561	2N1145	2N1303	2N1303
2N1043-2	2N1038	2N2565	2N1146	2N456A	2N456A
2N1044	2N1038	2N1044	2N1146A	2N456A	2N456B
2N1044-1	2N1038	2N2562	2N1146B	2N456A	2N1021A
2N1044-2	2N1038	2N2566	2N1146C	2N456A	2N3146
2N1045	2N1038	2N1045	2N1147	2N456A	2N456A
2N1045-1	2N1038	2N2563	2N1147A	2N456A	2N456B
2N1045-2	2N1038	2N2567	2N1147B	2N456A	2N1021A
2N1046	2N1907	2N1046	2N1147C	2N456A	2N3146
2N1046A	2N1907	2N1046	2N1149		2N1149
2N1046B	2N1907	2N1046	2N1150		2N1150
2N1047		2N1047	2N1151		2N1151
2N1047A		2N1047A	2N1152		2N1152
2N1047B		2N1047B	2N1153		2N1153
2N1048		2N1048	2N1154		2N1154
2N1048A		2N1048A	2N1155		2N1155
2N1048B		2N1048B	2N1156		2N1156
2N1049		2N1049	2N1158	2N5043	2N2996
2N1049A		2N1049A	2N1159	2N456A	2N3146
2N1049B		2N1049B	2N1160	2N456A	2N3146
2N1050		2N1050	2N1162	2N456A	2N514A
2N1050A		2N1050A	2N1162A	2N456A	2N514A
2N1050B		2N1050B	2N1163	2N456A	2N514A
2N1051	2N2219	2N2217	2N1163A	2N456A	2N514A
2N1052		2N5058	2N1168	TI3027	TI3027
2N1054		2N5059	2N1169		2N1995
2N1058	2N404	2N404	2N1170		2N1996
2N1059	2N404	2N404	2N1171	2N404	2N404
2N1060	2N2219	2N2217	2N1172	TI3027	TI3028
2N1065		2N2188	2N1173	2N1304	2N1605
2N1066		2N2189	2N1174	2N404	2N404A
2N1074		2N328A	2N1176	2N1038	2N1038
2N1075		2N328A	*2N1176A	2N1038	2N1038
2N1076		2N328A	*2N1176B	2N1038	2N1041
2N1078	2N404	2N404	2N1177		2N2188
2N1081	2N3725	2N3724	2N1178		2N2188
2N1082	2N2219	2N2217	2N1179		2N2188
2N1086	2N1308	2N1308	2N1180		2N2188
2N1086A	2N1308	2N1308	2N1183	2N1038	2N1038
2N1087	2N1308	2N1308	2N1183A	2N1038	2N1038
2N1090	2N1304	2N1605	2N1183B	2N1038	2N1039
2N1091	2N1304	2N1605	2N1184	2N1038	2N2564
2N1093	2N1305	2N1305	2N1184A	2N1038	2N2564
2N1094	2N1308	2N1308	2N1184B	2N1038	2N2565
2N1101	2N1302	2N1302	2N1185	2N1377	2N1375
2N1102	2N1306	2N1306	2N1186	2N1377	2N1375
2N1107		2N2188	2N1187	2N1377	2N1376
2N1108		2N2188	2N1188	2N1377	2N1376
2N1109		2N2188	2N1189	2N1377	2N1377
2N1110		2N2188	2N1190	2N1377	2N1377
2N1111		2N2188	2N1191	2N404	2N404
*2N1111A		2N2188	2N1192	2N404	2N404
*2N1111B		2N2188	2N1193	2N404	2N404
2N1116	2N2243A	2N2243	2N1194	2N404	2N404
2N1117	2N2243A	2N2193	2N1195	2N404	2N1195
2N1118	2N2605	2N2604	2N1198	2N1304	2N1304
2N1118A	2N2605	2N2604	2N1200	2N4252	2N4252
2N1119	2N2605	2N2604	2N1201	2N4252	2N4252
2N1120	TI3027	TI3031	2N1202	2N456A	2N3146
2N1121	2N1306	2N1306	2N1203	2N456A	2N3146
2N1122	2N964	2N964	2N1206		2N5059
2N1122A	2N964	2N964	2N1207		2N5059
2N1123	2N1997	2N1997	2N1209	2N1724	2N1724
2N1124	2N1377	2N1375	2N1210		2N1722
2N1125	2N2000	2N2000	2N1211		2N1722
2N1128	2N1377	2N1377	2N1212	2N1724	2N1724
2N1129	2N1377	2N1379	2N1217	2N1308	2N1308

*Denotes 1N- or 2N- numbers not JEDEC registered through September 1968.

CROSS-REFERENCE GUIDE BETWEEN JEDEC OR COMPETITIVE TYPE NUMBERS AND TI DEVICES (Cont'd.)

Type	Preferred TI Type	Nearest TI Type	Type	Preferred TI Type	Nearest TI Type
2N1220	2N2905	2N2904	2N1356	2N404	2N404
2N1221	2N2905	2N2904	2N1357	2N404	2N404
2N1222	2N2905	2N2904	2N1359	T13027	T13027
2N1223	2N2905	2N2904	2N1360	T13027	T13027
2N1224	2N2635	2N2635	2N1362	2N456A	2N3146
2N1225	2N2635	2N2635	2N1363	2N456A	2N3146
2N1226	2N2635	2N2635	2N1364	2N456A	2N3146
2N1227	T13027	T13027	2N1365	2N456A	2N3146
2N1235		2N1235	2N1366	2N1302	2N1302
2N1245	2N404	2N404	2N1367	2N1304	2N1304
2N1246	2N404	2N404	2N1370	2N1377	2N1370
2N1249		2N1248	2N1371	2N1377	2N1371
2N1251	2N1304	2N1304	2N1372	2N1377	2N1372
2N1252		2N1252	2N1373	2N1377	2N1373
2N1252A		2N1252	2N1374	2N1377	2N1374
2N1253		2N1253	2N1375	2N1377	2N1375
2N1253A		2N1253	2N1376	2N1377	2N1376
2N1254	2N2907	2N722	2N1377	2N1377	2N1377
2N1255	2N2907	2N722	2N1378	2N1377	2N1378
2N1256	2N2907	2N722	2N1379	2N1377	2N1379
2N1257	2N2907	2N722	2N1380	2N1377	2N1380
2N1258	2N2907	2N722	2N1381	2N1377	2N1381
2N1259	2N2907	2N722	2N1382	2N1377	2N1382
2N1260		2N1260	2N1383	2N1377	2N1383
2N1261	T13027	T13030	2N1384	2N2635	2N2635
2N1262	T13027	T13030	2N1385		2N1385
2N1263	T13027	T13030	2N1391		2N1302
2N1265	2N404	2N404	2N1395	2N1302	2N2188
2N1266	2N404	2N404	2N1396		2N2191
2N1267	2N4252	2N4253	2N1397		2N2191
2N1268	2N4252	2N4253	2N1398		2N2996
2N1269	2N4252	2N4253	2N1399		2N2996
2N1270	2N4252	2N4253	2N1400		2N2996
2N1271	2N4252	2N4253	2N1401		2N2996
2N1272	2N4252	2N4253	2N1402		2N2996
2N1273	2N404	2N1273	2N1403		2N2996
2N1274	2N404	2N1274	2N1404	2N1303	2N1404
2N1275	2N2945A	2N2944	2N1404A	2N1303	2N1404
2N1276		2N1276	2N1405		2N2996
2N1277		2N1277	2N1406		2N2996
2N1278		2N1278	2N1407		2N2996
2N1279		2N1279	2N1408	2N2000	2N2000
2N1280	2N1305	2N1305	2N1411		2N2188
2N1281	2N1305	2N1305	2N1413		2N1413
2N1282	2N1305	2N1305	2N1414		2N1414
2N1284	2N1305	2N1305	2N1415		2N1415
2N1285		2N1285	2N1416	2N404	2N404
2N1287	2N1303	2N1303	2N1420	2N1893	2N1420
2N1287A	2N1305	2N1305	2N1420A	2N1893	2N1420
2N1291	T13027	T13027	2N1425		2N2188
2N1293	T13027	T13028	2N1426		2N2188
2N1295	2N456A	2N3146	2N1427	2N2635	2N2635
2N1297	2N456A	2N3146	2N1428	2N2905	2N1132
2N1298	2N1302	2N1302	2N1429	2N2905	2N1132
2N1299	2N1306	2N1306	2N1431	2N1302	2N1302
2N1300	2N2635	2N2635	2N1432		2N2189
2N1301	2N2635	2N2635	2N1437	2N456A	2N3146
2N1302	2N1302	2N1302	2N1438	2N456A	2N3146
2N1303	2N1303	2N1303	2N1439	2N2945A	2N2946
2N1304	2N1304	2N1304	2N1440	2N2945A	2N2946
2N1305	2N1305	2N1305	2N1441	2N2945A	2N2946
2N1306	2N1306	2N1306	2N1442	2N2945A	2N2946
2N1307	2N1307	2N1307	2N1443	2N2945A	2N2946
2N1308	2N1308	2N1308	2N1444		2N3252
2N1309	2N1309	2N1309	2N1445		2N1445
2N1314	T13027	T13027	2N1446	2N1377	2N1373
2N1316	2N1997	2N1999	2N1447	2N1377	2N1373
2N1317	2N1997	2N1999	2N1448	2N1377	2N1373
2N1318	2N1997	2N1998	2N1449	2N1377	2N1375
2N1319		2N1319	2N1450		2N1143
2N1320	2N1038	2N1038	2N1451	2N1377	2N1375
2N1322	2N1038	2N1038	2N1452	2N1377	2N1375
2N1324	2N1038	2N1038	2N1465	2N456A	2N3146
2N1326	2N1038	2N1041	2N1466	2N456A	2N3146
2N1328	2N1038	2N1038	2N1469	2N2945A	2N2944
2N1343	2N404	2N404	2N1471	2N1309	2N1309
2N1344	2N404	2N404	2N1472	2N3015	2N2537
2N1345	2N404	2N404	2N1473	2N2000	2N2000
2N1346	2N404	2N404	2N1474	2N2945A	2N2944
2N1347	2N404	2N404	2N1474A	2N2945A	2N2944
*2N1348	2N404	2N404	2N1475	2N2945A	2N2944
*2N1349	2N404	2N404	2N1476	2N2945A	2N2944
*2N1350	2N404	2N404	2N1477	2N2945A	2N2944
*2N1351	2N404	2N404	2N1478	2N1997	2N1997
2N1353	2N404	2N404	2N1479	2N2987	2N2987
2N1354	2N404	2N404	2N1480	2N2988	2N2988
2N1355	2N404	2N404	2N1481	2N2989	2N2989
			2N1482	2N2990	2N2990

*Denotes 1N- or 2N- numbers not JEDEC registered through September 1968.

CROSS-REFERENCE GUIDE BETWEEN JEDEC OR COMPETITIVE TYPE NUMBERS AND TI DEVICES (Cont'd.)

Type	Preferred TI Type	Nearest TI Type	Type	Preferred TI Type	Nearest TI Type
2N1499	2N964	2N964	2N1587		2N1587
2N1499A	2N964	2N964	2N1588		2N1588
2N1499B	2N964	2N964	2N1589		2N1589
2N1500	2N964	2N964	2N1590		2N1590
2N1501	T13027	T13028	2N1591		2N1591
2N1502	T13027	T13028	2N1592		2N1592
2N1504	2N456A	2N3146	2N1593		2N1593
2N1505	2N2219	2N2217	2N1594		2N1594
2N1506	2N2219	2N2217	2N1595		2N1595
2N1507	2N1893	2N1507	2N1596		2N1596
*2N1515		2N2191	2N1597		2N1597
2N1516		2N2189	2N1598		2N1598
*2N1517		2N2189	2N1599		2N1599
2N1524	T1S37	2N2188	2N1600		2N1600
2N1525	T1S37	2N2188	2N1601		2N1601
2N1526	T1S37	2N2189	2N1602		2N1602
2N1527	T1S37	2N2189	2N1603		2N1603
2N1529		2N1529	2N1604		2N1604
2N1530		2N1530	2N1605	2N1304	2N1605
2N1531		2N1531	2N1605A	2N1304	2N1605
2N1532		2N1532	2N1613	2N1613	2N1613
2N1533		2N1533	2N1614	2N2000	2N2001
2N1534		2N1534	2N1616	2N1724	2N1724
2N1534A		2N1534	2N1617	2N1724	2N1724
2N1535		2N1535	2N1618	2N1724	2N1724
2N1535A		2N1535	2N1620	2N1724	2N1724
2N1536		2N1536	2N1624	2N1308	2N1308
2N1536A		2N1536	2N1631	2N2635	2N2635
2N1537		2N1537	2N1632	2N2635	2N2635
2N1537A		2N1537	2N1633	2N2635	2N2635
2N1538		2N1538	2N1634	2N2635	2N2635
2N1539	2N1539	2N1539	2N1635	2N2635	2N2635
2N1540		2N1540	2N1636	2N2635	2N2635
2N1540A		2N1540	2N1637	2N2635	2N2635
2N1541		2N1541	2N1638	2N2635	2N2635
2N1541A		2N1541	2N1639	2N2635	2N2635
2N1542		2N1542	2N1640	2N2945A	2N2946
2N1542A		2N1542	2N1641	2N2945A	2N2946
2N1543		2N1543	2N1642	2N2945A	2N2946
2N1544		2N1544	2N1643	2N2945A	2N2944
2N1544A		2N1544	2N1644	2N1893	2N1893
2N1545		2N1545	2N1647		2N2150
2N1545A		2N1545	2N1648		2N2151
2N1546		2N1546	2N1649		2N2150
2N1546A		2N1546	2N1650		2N2151
2N1547		2N1547	2N1654	2N2945A	2N2944
2N1547A		2N1547	2N1655	2N2945A	2N2944
2N1548		2N1548	2N1656	2N2945A	2N2944
2N1549		T13027	2N1660		2N1722
2N1549A	T13027	T13027	2N1661		2N1722
2N1550		T13028	2N1662		2N1722
2N1550A		T13028	2N1663	2N2369A	2N3011
2N1551		2N458B	2N1666	T13027	T13027
2N1551A		2N458B	2N1667	T13027	T13027
2N1552		2N1021A	2N1668	T13027	T13027
2N1552A		2N1021A	2N1669	T13027	T13027
2N1553	T13027	T13027	2N1670	2N398	2N398A
2N1553A	T13027	T13027	2N1671	2N1671B	2N1671
2N1554		T13028	2N1671A	2N1671B	2N1671A
2N1554A		T13028	2N1671B	2N1671B	2N1671B
2N1555		2N458B	2N1671C	2N1671B	2N1671B
2N1555A		2N458B	2N1672	2N1302	2N1302
2N1556		2N1021A	2N1672A	2N1304	2N1304
2N1556A		2N1021A	2N1673	2N404	2N404
2N1557	2N456A	2N514	2N1676	2N2945A	2N2944
2N1557A	2N456A	2N514	2N1677	2N2945A	2N2944
2N1558		2N514A	2N1678		2N2191
2N1558A		2N514A	2N1682	2N2219	2N2217
2N1559		2N514B	2N1683	2N2635	2N2635
2N1559A		2N514B	2N1690		2N1690
2N1560		2N1021A	2N1691		2N1691
2N1560A		2N1021A	2N1694	2N1302	2N1302
2N1564		2N1564	2N1704	2N1893	2N1893
2N1565		2N1565	2N1708		2N743
2N1566		2N1566	2N1708A		2N743
2N1566A		2N1566A	2N1711	2N1711	2N1711
2N1572		2N1572	2N1711A	2N1711	2N1711
2N1573		2N1573	2N1711B	2N1711	2N1711
2N1574		2N1574	2N1714		2N1714
2N1574A		2N1574	2N1715		2N1715
2N1586		2N1586	2N1716		2N1716

*Denotes 1N- or 2N- numbers not JEDEC registered through September 1968.

CROSS-REFERENCE GUIDE BETWEEN JEDEC OR COMPETITIVE TYPE NUMBERS AND TI DEVICES (Cont'd.)

Type	Preferred TI Type	Nearest TI Type	Type	Preferred TI Type	Nearest TI Type
2N1717		2N1717	2N1876	2N3555	2N3555
2N1718		2N1718	2N1877	2N3556	2N3556
2N1719		2N1719	2N1878	2N3557	2N3557
2N1720		2N1720	2N1879	2N3558	2N3558
2N1721		2N1721	2N1880	2N3558	2N3558
2N1722		2N1722	2N1886		2N2151
2N1722A		2N1722A	2N1889	2N1893	2N1889
2N1724	2N1724	2N1724	2N1890	2N1893	2N1890
2N1724A		2N1724A	2N1891		2N1891
2N1725		2N1725	2N1892	2N1303	2N1892
2N1726		2N2996	2N1893	2N1893	2N1893
2N1727		2N2996	2N1899	2N4002	2N4002
2N1728		2N2996	2N1901	2N4002	2N4002
2N1729	2N1303	2N1729	2N1905		2N1046
2N1730	2N1302	2N1730	2N1906	2N1907	2N1907
2N1731	2N1303	2N1731	2N1907	2N1907	2N1907
2N1732	2N1302	2N1732	2N1907A	2N1907	2N1907
2N1742		2N2996	2N1908	2N1907	2N1908
2N1743		2N2996	2N1908A	2N1907	2N1908
2N1744		2N2996	2N1917	2N2945A	2N2944
2N1745		2N2996	2N1918	2N2945A	2N2944
2N1746		2N2996	2N1919	2N2945A	2N2944
2N1747		2N2996	2N1920	2N2945A	2N2944
2N1748		2N2996	2N1921	2N2945A	2N2944
2N1748A		2N2997	2N1922	2N2945A	2N2944
2N1749		2N2996	2N1924		2N1924
2N1750		2N2996	2N1925		2N1925
2N1752		2N2996	2N1926		2N1926
2N1754		2N2996	2N1936		2N3846
2N1755	2N1038	2N2552	2N1937		2N3846
2N1756	2N1038	2N2554	2N1940		2N3027
2N1757	2N1038	2N2555	2N1943	T13027	T13027
2N1758	2N1038	2N2555	2N1944	2N1893	2N1893
2N1759	2N1038	2N2564	2N1945	2N1893	2N1893
2N1760	2N1038	2N2566	2N1946	2N1893	2N1893
2N1761	2N1038	2N2567	2N1954	2N2000	2N2000
2N1762	2N1038	2N2567	2N1955	2N2000	2N2000
2N1763		2N3014	2N1956	2N2000	2N2000
2N1764	2N2369A	2N3011	2N1957	2N2000	2N2000
2N1768		2N1050	2N1960	2N964	2N964
2N1769		2N1050	2N1961	2N964	2N964
2N1770		2N1770	2N1962	2N2369A	2N3011
2N1770A		2N1770A	2N1963	2N2369A	2N3011
2N1771		2N1771	2N1964	2N2537	2N2537
2N1771A		2N1771A	2N1965	2N3015	2N2537
2N1772		2N1772	2N1968		2N2997
2N1772A		2N1772A	2N1969		2N2996
2N1773		2N1773	2N1972	2N2243A	2N2192
2N1773A		2N1773A	2N1973	2N1893	2N1973
2N1774		2N1774	2N1974	2N1893	2N1974
2N1774A		2N1774A	2N1975	2N1893	2N1975
2N1775		2N1775	2N1986	2N697	2N696
2N1775A		2N1775A	2N1988	2N1893	2N1893
2N1776		2N1776	2N1989	2N1893	2N1893
2N1776A		2N1776A	2N1990	2N697	2N696
2N1777		2N1777	2N1991	2N2905	2N1131
2N1777A		2N1777A	2N1992	2N2369A	2N3011
2N1778		2N1778	2N1993	2N1302	2N1993
2N1785		2N2996	2N1994		2N1994
2N1786		2N2996	2N1995		2N1995
2N1787		2N2996	2N1996		2N1996
2N1788		2N2996	2N1997	2N1997	2N1997
2N1789		2N2996	2N1998	2N1997	2N1998
2N1790		2N2996	2N1999	2N1997	2N1999
2N1808	2N1302	2N1808	2N2000	2N2000	2N2000
2N1842B		2N1842B	2N2001	2N2000	2N2001
2N1843B		2N1843B	2N2002	2N2945A	2N2944
2N1844B		2N1844B	2N2003	2N2945A	2N2944
2N1845B		2N1845B	2N2004	2N2945A	2N2944
2N1846B		2N1846B	2N2005	2N2945A	2N2944
2N1847B		2N1847B	2N2006	2N2945A	2N2944
2N1848B		2N1848B	2N2007	2N2945A	2N2944
2N1849B		2N1849B	2N2008	2N2990	2N2990
2N1850B		2N1850B	2N2018	2N3996	2N3996
2N1853	2N2635	2N2635	2N2019	2N3996	2N3996
2N1854	2N2635	2N2635	2N2033	2N3420	2N3420
2N1864		2N2997	2N2034	2N3421	2N3421
2N1865		2N2997	2N2048	2N2635	2N2635
2N1866		2N2997	2N2049	2N1711	2N1711
2N1867		2N2997	2N2060	2N2060	2N2060
2N1868		2N2997	2N2060A	2N2060	2N2060
2N1869	2N3559	2N3559	2N2060B	2N2060	2N2060
2N1870	2N3559	2N3559	2N2061A	T13027	T13027
2N1871	2N3560	2N3560	2N2062A	T13027	T13027
2N1872	2N3561	2N3561	2N2063A	T13027	T13027
2N1873	2N3562	2N3562	2N2064A	T13027	T13027
2N1874	2N3562	2N3562	2N2065A	T13027	T13030
2N1875	2N3555	2N3555	2N2066A	T13027	T13030

CROSS-REFERENCE GUIDE BETWEEN JEDEC OR COMPETITIVE TYPE NUMBERS AND TI DEVICES (Cont'd.)

Type	Preferred TI Type	Nearest TI Type	Type	Preferred TI Type	Nearest TI Type
2N2067	2N1038	2N2553	2N2193B	2N2243A	2N2193A
2N2068	2N1038	2N2555	2N2194	2N2243A	2N2194
2N2084		2N2189	2N2194A	2N2243A	2N2194A
2N2085	2N1304	2N1304	2N2194B	2N2243A	2N2194A
2N2086	2N2243A	2N2243	2N2195	2N2219	2N2217
2N2087	2N2243A	2N2243	2N2195A	2N2219	2N2218
2N2089		2N2188	2N2195B	2N2219	2N2218
2N2090		2N2188	2N2197	2N2989	2N2989
2N2091		2N2188	2N2205		2N706
2N2092		2N2189	2N2206	2N3015	2N2410
2N2095		2N2999	2N2214		2N706
2N2096		2N2997	2N2216		2N3114
2N2097		2N2997	2N2217	2N2219	2N2217
2N2098		2N2999	2N2218	2N2219	2N2218
2N2099		2N2997	2N2218A	2N2219	2N2218A
2N2100		2N2997	2N2219	2N2219	2N2219
2N2102		2N2102	2N2219A		2N2219A
2N2102A		2N2102A	2N2220	2N2222	2N2220
2N2104	2N2905	2N2904A	2N2221	2N2222	2N2221
2N2105	2N2905	2N2904A	2N2221A	2N2222	2N2221A
2N2106	2N2987	2N2987	2N2222	2N2222	2N2222
2N2107	2N2987	2N2987	2N2222A	2N2222	2N2222A
2N2108	2N2989	2N2989	2N2222B	2N2222	2N2222
2N2109		2N3846	2N2223	2N2223	2N2223
2N2110		2N3846	2N2223A	2N2223	2N2223A
2N2111		2N3846	2N2224	2N2219	2N2218
2N2112		2N3846	2N2225		2N1143
2N2113		2N3846	2N2236	2N2243A	2N2193
2N2114		2N3846	2N2237	2N2243A	2N2192
2N2116		2N3846	2N2240	2N1893	2N699
2N2117		2N3846	2N2241	2N1893	2N1890
2N2118		2N3846	2N2242	2N2369A	2N2369
2N2119		2N3846	2N2243	2N2243A	2N2243
2N2123	2N4002	2N4002	2N2243A	2N2243A	2N2243A
2N2124	2N4002	2N4002	2N2244	2N930	2N929
2N2125	2N4002	2N4002	2N2245	2N930	2N929
2N2126	2N4002	2N4002	2N2246	2N930	2N929
2N2130	2N4002	2N4002	2N2247	2N930	2N929
2N2131	2N4002	2N4002	2N2248	2N930	2N929
2N2132	2N4002	2N4002	2N2249	2N930	2N929
2N2133	2N4002	2N4002	2N2250	2N930	2N929
2N2137	2N1038	2N2552	2N2251	2N930	2N929
2N2138	2N1038	2N2552	2N2252	2N930	2N929
2N2138A	2N1038	2N2552	2N2253	2N930	2N929
2N2139	2N1038	2N2554	2N2254	2N930	2N929
2N2139A	2N1038	2N2554	2N2255	2N930	2N929
2N2140	2N1038	2N2555	2N2258	2N964	2N972
2N2140A	2N1038	2N2555	2N2259	2N964	2N972
2N2141	2N1038	2N2555	2N2270	2N2243A	2N2270
2N2141A	2N1038	2N2555	2N2271	2N404	2N404
2N2147	2N1907	2N1907	2N2272		2N914
2N2148	2N1907	2N1908	2N2274	2N2945A	2N2944
2N2150		2N2150	2N2288	2N1907	2N1046
2N2151		2N2151	2N2291	2N1907	2N1907
2N2160	2N1671B	2N2160	2N2294	2N1907	2N1907
2N2162	2N2945A	2N2946	2N2297	2N2243A	2N2243A
2N2163	2N2945A	2N2944	2N2303		2N2303
2N2164	2N2945A	2N2944	2N2307		2N1671
2N2165	2N2945A	2N2946	2N2309	2N697	2N696
2N2166	2N2945A	2N2944	2N2310	2N1893	2N698
2N2167	2N2945A	2N2944	2N2311	2N1893	2N698
2N2168		2N2997	2N2312	2N1893	2N699
2N2169		2N2996	2N2313	2N1893	2N1889
2N2170		2N2996	2N2314	2N1893	2N698
2N2171	2N1377	2N1376	2N2315	2N1893	2N699
2N2172	2N1377	2N1376	2N2316	2N1893	2N1893
2N2173		2N2173	2N2317	2N1613	2N1613
2N2175	2N2945A	2N2944	2N2318		2N3014
2N2176	2N2945A	2N2944	2N2319		2N3014
2N2177	2N2945A	2N2944	2N2320		2N3014
2N2178	2N2945A	2N2944	2N2322		2N2322
2N2180	2N2635	2N2635	2N2323		2N2323
2N2181	2N2945A	2N2944	2N2324		2N2324
2N2182	3N111	3N108	2N2325		2N2325
2N2183	2N2945A	2N2944	2N2326		2N2326
2N2184	3N111	3N108	2N2330	2N2432	2N2432
2N2185	2N2945A	2N2944	2N2331	2N2432	2N2432
2N2186	3N111	3N108	2N2332	2N2945A	2N2944
2N2187	3N111	3N108	2N2333	2N2945A	2N2944
2N2188		2N2188	2N2334	2N2945A	2N2944
2N2189		2N2189	2N2335	2N2945A	2N2944
2N2190		2N2190	2N2336	2N2945A	2N2944
2N2191		2N2191	2N2337	2N2945A	2N2944
2N2192		2N2192	2N2339		2N1049
2N2192A	2N2243A	2N2192A	2N2349		TI495
2N2192B	2N2243A	2N2192A	2N2350	2N2243A	2N2192
2N2193	2N2243A	2N2193	2N2350A	2N2243A	2N2192
2N2193A	2N2243A	2N2193A	2N2351	2N2243A	2N2193

CROSS-REFERENCE GUIDE BETWEEN JEDEC OR COMPETITIVE TYPE NUMBERS AND TI DEVICES (Cont'd.)

Type	Preferred TI Type	Nearest TI Type	Type	Preferred TI Type	Nearest TI Type
2N2351A	2N2243A	2N2193A	2N2451	2N2635	2N2635
2N2352	2N2243A	2N2194	2N2452	LS600	LS600
2N2352A	2N2243A	2N2194A	2N2453	2N3680	2N2453
2N2353	2N2243A	2N2243	2N2453A	2N3680	2N3680
2N2353A	2N2243A	2N2243A	2N2456		2N2999
2N2354	2N1302	2N1302	2N2472	2N2432	2N2432
2N2356	3N79	3N76	2N2473	2N2432	2N2432
2N2356A	3N79	3N74	2N2474	2N2432	2N2432
2N2360		2N2997	2N2475	2N3013	2N3013
2N2361		2N2997	2N2476	2N3015	2N2539
2N2363		2N2997	2N2477	2N3015	2N2537
2N2364	2N2243A	2N2243A	2N2478	2N3015	2N2537
2N2364A	2N2243A	2N2243A	2N2479		2N3252
2N2368	2N2369A	2N2368	2N2480	2N2060	2N2060
2N2369	2N2369A	2N2369	2N2480A	2N2639	2N2640
2N2369A	2N2369A	2N2369A	2N2481		2N2481
2N2370	2N2945A	2N2944	2N2482	2N797	2N797
2N2371	2N2945A	2N2944	2N2483	2N2484	2N2483
2N2372	2N2945A	2N2944	2N2484	2N2484	2N2484
2N2373	2N2945A	2N2944	2N2484A	2N2484	2N2484
2N2374	2N404	2N404	2N2487		2N2996
2N2375	2N404	2N404	2N2488		2N2996
2N2376	2N404	2N404	2N2489		2N2996
2N2377	2N2945A	2N2944	2N2494		2N2996
2N2378	2N2945A	2N2944	2N2495		2N2996
2N2380	2N1893	2N1893	2N2496		2N2996
2N2380A	2N2219	2N2217	2N2497	2N2498	2N2497
2N2386	2N2386	2N2386	2N2498	2N2498	2N2498
2N2386A		2N2386A	2N2499	2N2498	2N2499
2N2387		2N2387	2N2500	2N2498	2N2500
2N2388		2N2388	2N2501		2N3014
2N2389		2N2389	2N2509		2N3014
2N2390		2N2390	2N2510	2N930	2N930
2N2393		2N2393	2N2511	2N2484	2N2586
2N2394		2N2394	2N2520	2N930	2N929
2N2395		2N2395	2N2521	2N930	2N929
2N2396		2N2396	2N2522	2N930	2N929
2N2397	2N2369A	2N3011	2N2523	2N930	2N929
2N2398		2N2997	2N2524	2N930	2N930
2N2399		2N2997	2N2535	2N1038	2N2565
2N2400	2N964	2N711	2N2536	2N1038	2N2565
2N2401	2N964	2N711A	2N2537	2N3015	2N2537
2N2402	2N964	2N711B	2N2538	2N3015	2N2538
2N2405	2N1893	2N1893	2N2539	2N3015	2N2539
2N2410	2N3015	2N2410	2N2540	2N3015	2N2540
2N2411		2N2411	2N2541	2N1038	2N1038
2N2412		2N2412	2N2552	2N1038	2N2552
2N2414	2N2060	2N2060	2N2553	2N1038	2N2553
2N2415		2N2415	2N2554	2N1038	2N2554
2N2416		2N2416	2N2555	2N1038	2N2555
2N2417	2N3980	2N3980	2N2556	2N1038	2N2556
2N2417A	2N3980	2N3980	2N2557	2N1038	2N2557
2N2417B	2N3980	2N3980	2N2558	2N1038	2N2558
2N2418	2N3980	2N3980	2N2559	2N1038	2N2559
2N2418A	2N3980	2N3980	2N2560	2N1038	2N2560
2N2418B	2N3980	2N3980	2N2561	2N1038	2N2561
2N2419	2N3980	2N3980	2N2562	2N1038	2N2562
2N2419A	2N3980	2N3980	2N2563	2N1038	2N2563
2N2419B	2N3980	2N3980	2N2564	2N1038	2N2564
2N2420	2N3980	2N3980	2N2565	2N1038	2N2565
2N2420A	2N3980	2N3980	2N2566	2N1038	2N2566
2N2420B	2N3980	2N3980	2N2567	2N1038	2N2567
2N2421	2N3980	2N3980	2N2569	2N2432	2N2432
2N2421A	2N3980	2N3980	2N2570	2N2432	2N2432
2N2421B	2N3980	2N3980	2N2581		2N3847
2N2422	2N3980	2N3980	2N2582		2N3847
2N2422A	2N3980	2N3980	2N2583		2N3847
2N2422B	2N3980	2N3980	2N2586	2N2484	2N2586
2N2423	2N456A	2N3146	2N2588	2N1038	2N2188
2N2424	2N2945A	2N2944	2N2590	2N2605	2N2604
2N2425	2N2945A	2N2946	2N2591	2N2605	2N2604
2N2427	2N930	2N929	2N2592	2N2605	2N2604
2N2428	2N1377	2N1381	2N2593	2N2605	2N2604
2N2429	2N1377	2N1381	2N2595	2N2605	2N2604
2N2430	2N1304	2N1605	2N2596	2N2605	2N2604
2N2431	2N1377	2N1381	2N2597		2N736
2N2432	2N2432	2N2432	2N2598	2N2605	2N2604
2N2432A	2N2432	2N2432A	2N2599	2N2605	2N2604
2N2437	2N1893	2N1893	2N2599A	2N2605	2N2604
2N2438	2N1893	2N1893	2N2600	2N2605	2N2604
2N2439	2N1893	2N1893	2N2600A	2N2605	2N2604
2N2443	2N1893	2N1890	2N2601	2N2605	2N2604
2N2444	2N456A	2N3146	2N2602	2N2605	2N2604
2N2445	2N456A	2N3146	2N2603	2N2605	2N2604
2N2447	2N1309	2N1309	2N2604	2N2605	2N2604
2N2448	2N1309	2N1309	2N2605	2N2605	2N2605
2N2449	2N1307	2N1307	2N2605A	2N2605	2N2605
2N2450	2N1307	2N1307	2N2606	2N3330	2N3575

CROSS-REFERENCE GUIDE BETWEEN JEDEC OR COMPETITIVE TYPE NUMBERS AND TI DEVICES (Cont'd.)

Type	Preferred TI Type	Nearest TI Type	Type	Preferred TI Type	Nearest TI Type
2N2607	2N3330	2N3575	2N2819		2N3846
2N2608	2N3330	2N3575	2N2820		2N3846
2N2609	2N3330	2N3575	2N2821		2N3846
2N2610		2N1149	2N2822		2N3846
2N2612	TI3027	TI3031	2N2823		2N3846
2N2613	2N404	2N404	2N2824		2N3846
2N2614	2N404	2N404	2N2825		2N3846
2N2616	2N918	2N917	2N2832	2N1907	2N1908
2N2617	2N2945A	2N2944	2N2835	2N1038	2N2564
2N2632	2N3421	2N3421	2N2836	TI3027	TI3029
2N2633	2N3421	2N3421	2N2837	2N2905	2N2904
2N2634	2N3421	2N3421	2N2838	2N2905	2N2904
2N2635	2N2635	2N2635	2N2840	2N491A	2N489
2N2639	2N2639	2N2639	2N2841	2N3330	2N3573
2N2640	2N2639	2N2640	2N2842	2N3330	2N3574
2N2641	2N2639	2N2641	2N2843	2N3330	2N3575
2N2642	2N2642	2N2642	2N2844	2N3330	2N3575
2N2643	2N2642	2N2643	2N2845	2N3015	2N2537
2N2644	2N2643	2N2644	2N2846	2N3015	2N2537
2N2645	2N1711	2N1711	2N2847	2N3015	2N2537
2N2646		TI543	2N2848	2N3015	2N2537
2N2647	2N3980	2N3980	2N2850	2N3421	2N3421
2N2648	2N1377	2N1379	2N2851	2N3421	2N3421
2N2651		2N3554	2N2852	2N3419	2N3419
2N2652	2N2639	2N2639	2N2853	2N3418	2N3418
2N2652A	2N2639	2N2639	2N2855	2N3420	2N3420
2N2653		2N2653	2N2856	2N3418	2N3418
2N2657		2N2151	2N2857	2N918	2N918
2N2658		2N2151	2N2860	2N964	2N964
2N2659	2N1038	2N2659	2N2861		2N2861
2N2660	2N1038	2N2660	2N2862		2N2862
2N2661	2N1038	2N2661	2N2863		2N2863
2N2662	2N1038	2N2662	2N2864		2N2864
2N2663	2N1038	2N2663	2N2865		2N2865
2N2664	2N1038	2N2664	2N2868	2N1893	2N699
2N2665	2N1038	2N2665	2N2869	TI3027	TI3030
2N2666	2N1038	2N2666	2N2870	TI3027	TI3030
2N2667	2N1038	2N2667	2N2873		2N2997
2N2668	2N1038	2N2668	2N2875		2N3418
2N2669	2N1038	2N2669	2N2877	2N3418	2N3998
2N2670		2N2670	2N2878	2N3998	2N3998
2N2687		2N2687	2N2879	2N3998	2N3998
2N2688		2N2688	2N2880	2N3998	2N3998
2N2689		2N2689	2N2881	2N5333	2N5333
2N2690		2N2690	2N2882	2N5333	2N5333
2N2692		2N2692	2N2883		2N2883
2N2693		2N2693	2N2884		2N2884
2N2694		2N2694	2N2885		2N849
2N2695	2N2907	2N2695	2N2886	2N697	2N696
2N2696	2N2907	2N2696	2N2890	2N3421	2N3421
2N2697	2N3998	2N3998	2N2891	2N3421	2N3421
2N2698	2N3998	2N3998	2N2892	2N3998	2N3998
2N2699	2N964	2N964	2N2894	2N2894	2N2894
2N2706	2N404	2N404	2N2894	2N2894	2N2894
2N2708	2N918	2N918	2N2901	3N79	3N74
2N2709	2N2945A	2N2944	2N2902		2N2902
2N2711	TI598	TI598	2N2902		2N2640
2N2712	TI598	TI598	2N2903	2N2639	2N2639
2N2713	TI598	TI598	2N2903A	2N2905	2N2904
2N2714	TI598	TI598	2N2904	2N2905	2N2904A
2N2715	TI598	TI598	2N2904A	2N2905	2N2905
2N2717	2N2635	2N2635	2N2905	2N2905	2N2905A
2N2720	2N2639	2N2639	2N2905A	2N2905	2N2905A
2N2721	2N2639	2N2639	2N2906	2N2907	2N2906
2N2722	2N2639	2N2639	2N2907	2N2907	2N2907
2N2784	2N3010	2N3010	2N2907A	2N2907	2N2907A
2N2795	2N2635	2N2635	2N2909	2N2243A	2N2193A
2N2796	2N2635	2N2635	2N2910	2N2639	2N2639
2N2797	2N2635	2N2635	2N2911		2N3421
2N2798	2N2635	2N2635	2N2913	2N2643	2N2913
2N2799	2N2635	2N2635	2N2914	2N2643	2N2914
2N2800	2N2905	2N2904	2N2915	2N3680	2N2915
2N2801		2N3244	2N2915A	2N3680	2N2915
2N2802	2N3350	2N2802	2N2916	2N3680	2N2916
2N2803	2N3351	2N2803	2N2916A	2N3680	2N2916
2N2804	2N3351	2N2804	2N2917	2N2642	2N2917
2N2805	2N3351	2N2805	2N2918	2N2642	2N2918
2N2806	2N3351	2N2806	2N2919	2N3680	2N2919
2N2807	2N3351	2N2807	2N2919A	2N3680	2N2919
2N2811	2N4301	2N4301	2N2920	2N3680	2N2920
2N2812	2N4301	2N4301	2N2920A	2N3680	2N2920
2N2813	2N4301	2N4301	2N2921	TI598	TI598
2N2814	2N4301	2N4301	2N2922	TI598	TI598
2N2815	2N4002	2N4002	2N2923	TI598	TI598
2N2816		2N3846	2N2924	TI598	TI598
2N2817		2N3846	2N2925	TI598	TI598
2N2818		2N3846	2N2926	TI598	TI598
			2N2929		2N1141
			2N2936	2N2639	2N2639
			2N2937	2N2639	2N2639

CROSS-REFERENCE GUIDE BETWEEN JEDEC OR COMPETITIVE TYPE NUMBERS AND TI DEVICES (Cont'd.)

Type	Preferred TI Type	Nearest TI Type	Type	Preferred TI Type	Nearest TI Type
2N2942	2N2635	2N2635	2N3067	2N3822	2N3821
2N2943	2N2635	2N2635	2N3068	2N3822	2N3821
2N2944	2N2945A	2N2944	2N3069	2N3822	2N3821
2N2944A	2N2945A	2N2944A	2N3070	2N3822	2N3821
2N2945	2N2945A	2N2945	2N3071	2N3822	2N3821
2N2945A	2N2945A	2N2945A	2N3072	2N2905	2N2904
2N2946	2N2945A	2N2946	2N3073	2N2907	2N2906
2N2946A	2N2945A	2N2946A	2N3077	2N2484	2N2484
2N2953	2N404	2N404	2N3079		2N3846
2N2954	2N918	2N918	2N3080		2N3847
2N2955	2N2635	2N2635	2N3082	3N79	3N76
2N2956	2N2635	2N2635	2N3083	3N79	3N74
2N2957	2N2635	2N2635	2N3084	2N3822	2N3821
2N2958	2N2219	2N2217	2N3085	2N3822	2N3821
2N2959	2N697	2N697	2N3086	2N3822	2N3821
2N2966		2N2997	2N3087	2N3822	2N3821
2N2968	2N2945A	2N2944	2N3088	2N3822	2N3821
2N2969	2N2945A	2N2944	2N3088A	2N3822	2N3821
2N2970	2N2945A	2N2944	2N3089	2N3822	2N3821
2N2971	2N2945A	2N2944	2N3089A	2N3822	2N3821
2N2987	2N2987	2N2987	2N3107	2N2243A	2N2243
2N2988	2N2988	2N2988	2N3108	2N1613	2N1613
2N2989	2N2989	2N2989	2N3109	2N697	2N697
2N2990	2N2990	2N2990	2N3110	2N2243A	2N2243A
2N2991	2N2991	2N2991	2N3114		2N3114
2N2992	2N2992	2N2992	2N3115	2N2222	2N2221
2N2993	2N2993	2N2993	2N3116	2N2222	2N2221
2N2994	2N2994	2N2994	2N3117	2N2484	2N3117
2N2996		2N2996	2N3121	2N2907	2N2906
2N2997		2N2997	2N3125	2N456A	2N3146
2N2998		2N2998	2N3126	2N456A	2N3146
2N2999		2N2999	2N3132	TI3027	TI3031
2N3001	2N3001	2N3001	2N3133	2N2905	2N2904
2N3002	2N3002	2N3002	2N3134	2N2905	2N2905
2N3003	2N3003	2N3003	2N3137		2N3014
2N3004	2N3004	2N3004	2N3146	2N456A	2N3146
2N3005	2N3005	2N3005	2N3147	2N456A	2N3147
2N3006	2N3006	2N3006	2N3153	2N2432	2N2432
2N3007	2N3007	2N3007	2N3202	2N5333	2N5333
2N3008	2N3008	2N3008	2N3203	2N5333	2N5333
2N3009		2N3009	2N3204	2N5333	2N5333
2N3010	2N3010	2N3010	2N3205	2N5333	2N5333
2N3011	2N2369A	2N3011	2N3206	2N5333	2N5333
2N3012	2N2894	2N3012	2N3207	2N5333	2N5333
2N3013	2N3013	2N3013	2N3208	2N5333	2N5333
2N3014		2N3014	2N3209	2N2894	2N3576
2N3015	2N3015	2N3015	2N3217	2N2945A	2N2944
2N3019	2N2243A	2N2243A	2N3218	2N2945A	2N2944
2N3020	2N1893	2N1893	2N3219	2N2945A	2N2944
2N3021	2N5384	2N5384	2N3224	2N2905	2N2904
2N3022	2N5384	2N5384	2N3227	2N2369A	2N3011
2N3023	2N5384	2N5384	2N3242	2N718A	2N730
2N3024	2N5384	2N5384	2N3242A	2N718A	2N730
2N3025	2N5384	2N5384	2N3244		2N3244
2N3026	2N5384	2N5384	2N3245		2N3245
2N3033		2N3033	2N3246	2N2484	2N2484
2N3034		2N3034	2N3247	2N2484	2N2484
2N3035		2N3035	2N3248	2N2894	2N2894
2N3036	2N2243A	2N3036	2N3249	2N2894	2N2894
2N3037		2N3037	2N3250	2N3250	2N3250
2N3038		2N3038	2N3250A		2N3250A
2N3039		2N3039	2N3251	2N3250	2N3251
2N3040		2N3040	2N3251A		2N3251A
2N3043	2N3043	2N3043	2N3252		2N3252
2N3044	2N3043	2N3044	2N3253		2N3253
2N3045	2N3045	2N3045	2N3263	2N4002	2N4002
2N3046	2N3043	2N3046	2N3264	2N4002	2N4002
2N3047	2N3043	2N3047	2N3265	2N4002	2N4002
2N3048	2N8045	2N3048	2N3266	2N4002	2N4002
2N3049	2N3049	2N3049	2N3267		2N3267
2N3050	2N3049	2N3050	2N3268		2N337
2N3051	2N3051	2N3051	2N3277	2N3330	2N3328
2N3052		2N3052	2N3278	2N3330	2N3328
2N3053	2N2243A	2N3053	2N3279		2N2997
2N3055	2N3055	2N3055	2N3280		2N2997
2N3056	2N2243A	2N2243	2N3281		2N2996
2N3056A	2N2243A	2N2243A	2N3282		2N2996
2N3057	2N2243A	2N2243	2N3283		2N2996
2N3057A	2N2243A	2N2243A	2N3284		2N2996
2N3058	2N2945A	2N2944	2N3285		2N2996
2N3059	2N2945A	2N2944	2N3286		2N2996
2N3060	2N2945A	2N2944	2N3287	2N2945A	2N2944
2N3061	2N2945A	2N2944	2N3288	2N2945A	2N2944
2N3062	2N2945A	2N2944	2N3289	2N918	2N918
2N3063	2N2945A	2N2944	2N3291	2N918	2N918
2N3064	2N2945A	2N2944	2N3292	2N918	2N918
2N3065	2N2945A	2N2944	2N3293	2N918	2N918
2N3066	2N3822	2N3821	2N3294	2N918	2N918

CROSS-REFERENCE GUIDE BETWEEN JEDEC OR COMPETITIVE TYPE NUMBERS AND TI DEVICES (Cont'd.)

Type	Preferred TI Type	Nearest TI Type	Type	Preferred TI Type	Nearest TI Type
2N3295	2N2219	2N2217	2N3428	2N1377	2N1377
2N3299	2N3015	2N2537	2N3436	2N3822	2N3822
2N3303		2N3303	2N3437	2N3822	2N3821
2N3304	2N3304	2N3304	2N3438	2N3822	2N3821
2N3305	2N2907	2N2907	2N3439		2N3821
2N3306	2N2907	2N2907	2N3444		2N3821
2N3317	2N2945A	2N2944	2N3449		2N3449
2N3318	2N2945A	2N2944	2N3452	2N3822	2N3821
2N3319	2N2945A	2N2944	2N3453	2N3822	2N3821
2N3320	2N2945A	2N2944	2N3454	2N3822	2N3821
2N3321	2N964	2N964	2N3455	2N3822	2N3821
2N3328		2N3328	2N3456	2N3822	2N3821
2N3329	2N3330	2N3329	2N3457	2N3822	2N3821
2N3330	2N3330	2N3330	2N3458	2N3822	2N3822
2N3331	2N3330	2N3331	2N3459	2N3822	2N3821
2N3332	2N3330	2N3332	2N3460	2N3822	2N3821
2N3333		2N3333	2N3465	2N3822	2N3822
2N3334		2N3334	2N3466	2N3822	2N3822
2N3335		2N3335	2N3467	2N3822	2N3822
2N3336		2N3336	2N3468	2N3467	2N3467
2N3337		2N2883	2N3469	2N3420	2N3420
2N3338		2N2883	2N3479	2N491A	2N489A
2N3339		2N2883	2N3480	2N3980	2N3980
2N3341	2N2605	2N2604	2N3481	2N3980	2N3980
2N3342	2N2945A	2N2944	2N3482	2N3980	2N3980
2N3343	2N2945A	2N2944	2N3483	2N3980	2N3980
2N3344	2N2945A	2N2944	2N3485	2N3486	2N3485
2N3345	2N2945A	2N2944	2N3485A	2N3486	2N3485A
2N3346	2N2945A	2N2944	2N3486	2N3486	2N3486
2N3347	2N3350	2N3347	2N3486A	2N3486	2N3486A
2N3348	2N3351	2N3348	2N3493	2N4252	2N4252
2N3349	2N3351	2N3349	2N3494	2N3495	2N3494
2N3350	2N3350	2N3350	2N3495	2N3495	2N3495
2N3351	2N3351	2N3351	2N3496	2N3495	2N3496
2N3352	2N3351	2N3352	2N3497	2N3495	2N3497
2N3365	2N3822	2N3821	2N3498	2N697	2N698
2N3366	2N3822	2N3821	2N3499		2N5058
2N3367	2N3822	2N3821	2N3500	2N2243A	2N2243
2N3368	2N3822	2N3821	2N3501	2N2243A	2N2243
2N3369	2N3822	2N3821	2N3502	2N2905	2N3502
2N3370	2N3822	2N3821	2N3503	2N2905	2N3503
2N3371		2N3371	2N3504	2N5447	2N5447
2N3375		2N3375	2N3504	2N2907	2N3504
2N3376	2N3330	2N3329	2N3505	2N2907	2N3505
2N3377	2N3330	2N3329	2N3506	2N2989	2N2989
2N3378	2N3330	2N3330	2N3507	2N2989	2N2989
2N3379	2N3330	2N3330	2N3512	2N3015	2N2537
2N3380	2N3330	2N3331	2N3513	2N2639	2N2640
2N3381	2N3330	2N3331	2N3516	2N2639	2N2639
2N3382	2N3993	2N3994	2N3518	2N3043	2N3046
2N3383	2N3993	2N3994	2N3520	2N3043	2N3043
2N3384	2N3993	2N3994	2N3521	2N2643	2N2643
2N3385	2N3993	2N3994	2N3522	2N2643	2N2643
2N3386	2N3993	2N3994	2N3524	2N2639	2N2640
2N3387	2N3993	2N3994	2N3527	2N2945A	2N2944
2N3390	TIS98	TIS98	2N3544	2N918	2N918
2N3391	TIS98	TIS98	2N3546	2N2894	2N3576
2N3391A	TIS98	TIS98	2N3549	2N2605	2N2604
2N3392	TIS98	TIS98	2N3550	2N2945A	2N2944
2N3393	TIS98	TIS98	2N3551	2N3551	2N3551
2N3394	TIS98	TIS98	2N3552	2N3552	2N3552
2N3395	TIS98	TIS98	2N3554		2N3554
2N3396	TIS98	TIS98	2N3555	2N3555	2N3555
2N3397	TIS98	TIS98	2N3556	2N3556	2N3556
2N3398	TIS98	TIS98	2N3557	2N3557	2N3557
2N3399		2N2996	2N3558	2N3558	2N3558
2N3401	2N2945A	2N2944	2N3559	2N3559	2N3559
2N3402	2N5449	2N5449	2N3560	2N3560	2N3560
2N3403	2N5449	2N5449	2N3561	2N3561	2N3561
2N3404	2N5449	2N5449	2N3562	2N3562	2N3562
2N3405	2N5449	2N5449	2N3563	TIS62	TIS62
2N3406	2N1671B	2N1671	2N3565	TIS98	TIS98
2N3409	2N2639	2N2639	2N3566	2N5449	2N5449
2N3410	2N2639	2N2639	2N3570	2N3570	2N3570
2N3411	2N2639	2N2639	2N3571	2N3570	2N3571
2N3414	2N5449	2N5449	2N3572	2N3572	2N3572
2N3415	2N5449	2N5449	2N3573	2N3573	2N3573
2N3416	2N5449	2N5449	2N3574	2N3574	2N3574
2N3417	2N5449	2N5449	2N3575	2N3575	2N3575
2N3418	2N3418	2N3418	2N3576	2N3576	2N3576
2N3419	2N3419	2N3419	2N3578	2N3330	2N3329
2N3420	2N3420	2N3420	2N3579	2N2605	2N2604
2N3421	2N3421	2N3421	2N3580	2N2605	2N2605
2N3423	2N2639	2N2639	2N3581	2N2605	2N2605
2N3424	2N2639	2N2639	2N3582	2N2605	2N2605
2N3425	2N2639	2N3014	2N3597	2N4002	2N4002
2N3426		2N3303	2N3598	2N4002	2N4002
2N3427	2N1377	2N1377	2N3599	2N4002	2N4002

CROSS-REFERENCE GUIDE BETWEEN JEDEC OR COMPETITIVE TYPE NUMBERS AND TI DEVICES (Cont'd.)

Type	Preferred TI Type	Nearest TI Type	Type	Preferred TI Type	Nearest TI Type
2N3600		2N918	2N3802	2N3350	2N3347
2N3608		3N160	2N3803	2N3351	2N3351
2N3610		3N160	2N3804	2N3350	2N3350
2N3611	TI3027	TI3027	2N3804A	2N3350	2N3350
2N3613	TI3027	TI3027	2N3805	2N3350	2N3350
2N3614	TI3027	TI3028	2N3805A	2N3350	2N3350
2N3615	TI3027	TI3031	2N3806	2N3351	2N3806
2N3616	2N456A	2N3146	2N3807	2N3351	2N3807
2N3617	TI3027	TI3030	2N3808	2N3350	2N3808
2N3618		2N3146	2N3809	2N3350	2N3809
2N3632		2N3632	2N3810	2N3350	2N3810
2N3638	2N5447	2N5447	2N3810A	2N3350	2N3810
2N3638A	2N5447	2N5447	2N3811	2N3351	2N3811
2N3641	2N5449	2N5449	2N3811A	2N3351	2N3811
2N3642	2N5449	2N5449	2N3819	2N3819	2N3819
2N3643	2N5449	2N5449	2N3820	2N3820	2N3820
2N3644	2N5449	2N5449	2N3821	2N3822	2N3821
2N3647		2N3303	2N3822	2N3822	2N3822
2N3648		2N3303	2N3823	2N3823	2N3823
2N3659		2N5058	2N3824	2N3824	2N3824
2N3665	2N2432	2N2432	2N3826	2N3826	2N3826
2N3666	2N2432	2N2432	2N3827	2N3827	2N3827
2N3671	2N2905	2N2905	2N3828	2N3828	2N3828
2N3672	2N2905	2N2905	2N3829	2N3829	2N3829
2N3673	2N2905	2N2905	2N3830	2N3830	2N3830
2N3677	2N2945A	2N2944	2N3831	2N3831	2N3831
2N3679	2N3980	2N3980	2N3832	2N3832	2N3832
2N3680		2N3680	2N3833	2N3833	2N3833
2N3681	2N3570	2N3570	2N3834	2N3834	2N3834
2N3682	2N918	2N918	2N3835	2N3835	2N3835
2N3683	2N3570	2N3570	2N3838	2N3838	2N3838
2N3684	2N3822	2N3822	2N3839	2N3839	2N3571
2N3685	2N3822	2N3821	2N3840	2N2945A	2N2946
2N3686	2N3822	2N3821	2N3841	2N2945A	2N2946
2N3687	2N3822	2N3821	2N3842	2N2945A	2N2946
2N3691	TIS98	TIS98	2N3846		2N3846
2N3692	TIS98	TIS98	2N3847		2N3847
2N3695	2N3330	2N3575	2N3850	2N3998	2N3998
2N3696	2N3330	2N3575	2N3851	2N3998	2N3998
2N3697	2N3330	2N3575	2N3852	2N3998	2N3998
2N3702	2N5447	2N3702	2N3853	2N3998	2N3998
2N3703	2N5448	2N3703	2N3857	2N2945A	2N2944
2N3704	2N5449	2N3704	2N3858	TIS98	TIS98
2N3705	2N5450	2N3705	2N3858A	TIS98	TIS98
2N3706	2N5451	2N3706	2N3859	TIS98	TIS98
2N3707	2N3707	2N3707	2N3860	TIS98	TIS98
2N3708	2N3708	2N3708	2N3866	2N3866	2N3866
2N3709	2N3709	2N3709	2N3867	2N5333	2N5333
2N3710	2N3710	2N3710	2N3868	2N5333	2N5333
2N3711	2N3711	2N3711	2N3877	TIS98	TIS98
2N3712		2N3712	2N3877A	TIS98	TIS98
2N3713	2N3713	2N3713	2N3900	TIS98	TIS98
2N3714	2N3714	2N3714	2N3900A	TIS98	TIS98
2N3715	2N3715	2N3715	2N3909	2N3909	2N3909
2N3716	2N3716	2N3716	2N3909A	2N3909A	2N3909A
2N3719	2N5333	2N5333	2N3910	2N2945A	2N2944
2N3720	2N5333	2N5333	2N3911	2N2945A	2N2944
2N3722	2N3015	2N3015	2N3912	2N2945A	2N2944
2N3723	2N3015	2N3015	2N3913	2N2945A	2N2944
2N3724	2N3725	2N3724	2N3914	2N2945A	2N2944
2N3724A	2N3725	2N3724A	2N3915	2N2945A	2N2944
2N3725	2N3725	2N3725	2N3921	2N5045	TIS25
2N3725A	2N3725	2N3725A	2N3922	2N5045	TIS25
2N3733		2N3733	2N3930	2N3495	2N3497
2N3737	2N3725	2N3725A	2N3934	2N5045	TIS25
2N3742		2N5058	2N3935	2N5045	TIS25
2N3744	2N3996	2N3996	2N3936		2N3936
2N3745	2N3996	2N3996	2N3937		2N3937
2N3746	2N3996	2N3996	2N3938		2N3938
2N3747	2N3996	2N3996	2N3939		2N3939
2N3748	2N3996	2N3996	2N3940		2N3940
2N3749	2N3996	2N3996	2N3941		2N2920
2N3750	2N3996	2N3996	2N3942		2N2920
2N3751	2N3996	2N3996	2N3943		2N2920
2N3752	2N3996	2N3996	2N3944		2N2920
2N3752		2N3244	2N3946	2N2219	2N2217
2N3764	2N3486	2N3486	2N3947	2N2219	2N2217
2N3765	2N3486	2N3486A	2N3954	2N5045	TIS25
2N3771		2N3771	2N3955	2N5045	TIS25
2N3772		2N3772	2N3956	2N5045	TIS25
2N3783	2N5043	TIXM101	2N3957	2N5045	TIS25
2N3784	2N5043	TIXM101	2N3958	2N5045	TIS25
2N3796	2N3823	2N3823	2N3962	2N3964	2N3962
2N3797	2N3823	2N3823	2N3963	2N3964	2N3963
2N3798	2N2605	2N3798	2N3964	2N3964	2N3964
2N3799	2N2605	2N3799	2N3965	2N3964	2N3965
2N3800	2N3351	2N3352	2N3966	2N3823	2N3824
2N3801	2N3351	2N3352	2N3967	2N3822	2N3822

CROSS-REFERENCE GUIDE BETWEEN JEDEC OR COMPETITIVE TYPE NUMBERS AND TI DEVICES (Cont'd.)

Type	Preferred TI Type	Nearest TI Type	Type	Preferred TI Type	Nearest TI Type
2N3967A	2N3822	2N3821	2N4117	2N3822	2N3821
2N3968	2N3822	2N3821	2N4117A	2N3822	2N3821
2N3968A	2N3822	2N3821	2N4118	2N3822	2N3821
2N3969	2N3822	2N3821	2N4118A	2N3822	2N3821
2N3969A	2N3822	2N3821	2N4119	2N3822	2N3821
2N3970	2N4857	2N3970	2N4119A	2N3822	2N3821
2N3971	2N4857	2N3971	2N4120		3N160
2N3972	2N4857	2N3972	2N4121	2N4423	2N4423
2N3973	2N5449	2N5449	2N4122	2N4423	2N4423
2N3974	2N5449	2N5449	2N4123	TIS99	TIS99
2N3975	2N5449	2N5449	2N4124	TIS98	TIS98
2N3976	2N5449	2N5449	2N4125	2N5447	2N5447
2N3977	2N2945A	2N2944	2N4126	2N4061	2N4061
2N3978	2N2945A	2N2944	2N4138	2N2432	2N4138
2N3979	2N2945A	2N2944	2N4139	2N3823	2N3823
2N3980	2N3980	2N3980	2N4150	2N3421	2N3421
2N3983	TIS62	TI407	2N4210	2N4002	2N4002
2N3984	TIS63	TI408	2N4211	2N4002	2N4002
2N3985	TIS63	TI409	2N4220	2N3822	2N3821
2N3993	2N3993	2N3993	2N4220A	2N3822	2N3821
2N3994	2N3993	2N3994	2N4221	2N3822	2N3822
2N3995		2N3995	2N4221A	2N3822	2N3822
2N3996	2N3996	2N3996	2N4222	2N3823	2N3821
2N3997	2N3997	2N3997	2N4222A	2N3823	2N3821
2N3998	2N3998	2N3998	2N4223	2N3823	2N3823
2N3999	2N3999	2N3999	2N4224	2N3819	2N3819
2N4000	2N4000	2N4000	2N4235	2N5333	2N5333
2N4001	2N4001	2N4001	2N4236	2N5333	2N5333
2N4002	2N4002	2N4002	2N4241	TI3027	TI3027
2N4003	2N4003	2N4003	2N4242	TI3027	TI3028
2N4004		2N4004	2N4243	TI3027	TI3028
2N4005		2N4005	2N4244	TI3027	TI3028
2N4008	2N2945A	2N2944	2N4245	TI3027	TI3028
2N4014	2N2219	2N2219A	2N4246	TI3027	TI3028
2N4015	2N3350	2N3350	2N4247	TI3027	TI3028
2N4016	2N3350	2N3350	2N4248	2N4058	2N4058
2N4017	2N3351	2N3352	2N4249	2N4058	2N4058
2N4018	2N3351	2N3352	2N4250	2N4059	2N4059
2N4020	2N3350	2N3350	2N4252	2N4252	2N4252
2N4021	2N3350	2N3350	2N4253	2N4252	2N4253
2N4022	2N3350	2N3350	2N4254		2N4254
2N4023	2N3350	2N3350	2N4255		2N4255
2N4024	2N3350	2N3350	2N4259	2N4252	2N4252
2N4025	2N3350	2N3350	2N4267		3N160
2N4026	2N2907	2N2906A	2N4268		3N160
2N4027	2N2907	2N2906A	2N4269	2N2243A	2N2243A
2N4028	2N2907	2N2907A	2N4274	2N4418	2N4419
2N4029	2N2907	2N2907A	2N4275	2N4418	2N4418
2N4030		2N4030	2N4284	2N4060	2N4060
2N4031		2N4031	2N4285	2N4060	2N4060
2N4032		2N4032	2N4286	TIS98	TIS98
2N4033		2N4033	2N4287	TIS98	TIS98
2N4034	2N3250	2N3250	2N4288	2N4062	2N4062
2N4035	2N3250	2N3250	2N4289	2N4062	2N4062
2N4036	2N2905	2N2904	2N4290	2N5447	2N3702
2N4037	2N2905	2N2904	2N4291	2N5447	2N3702
2N4040		2N4040	2N4292	TIS62	TIS62
2N4041		2N4041	2N4293	TIS62	TIS62
2N4042	2N3680	2N3680	2N4300	2N4300	2N4300
2N4043	2N3680	2N3680	2N4301	2N4301	2N4301
2N4044	2N3680	2N3680	2N4302	TIS88	2N5246
2N4045	2N3680	2N3680	2N4303	TIS88	2N5245
2N4046		2N3252	2N4304	2N3819	2N3819
2N4058	2N4058	2N4058	2N4313	2N4423	2N4423
2N4059	2N4059	2N4059	2N4338	2N3822	2N3821
2N4060	2N4060	2N4060	2N4339	2N3822	2N3821
2N4061	2N4061	2N4061	2N4340	2N3822	2N3821
2N4062	2N4062	2N4062	2N4341	2N3822	2N3822
2N4065	3N160	3N160	2N4342	2N3820	2N3820
2N4066	3N160	3N160	2N4343	2N3820	2N3820
2N4072		2N2863	2N4357	2N3495	2N3494
2N4073		2N2863	2N4358	2N3495	2N3494
2N4075	2N3996	2N3996	2N4360	2N3820	2N3820
2N4076	2N3996	2N3996	2N4381	2N3330	2N3330
2N4081	2N4252	2N4252	2N4382	2N3330	2N3331
2N4082	2N5045	TIS25	2N4390		2N5058
2N4083	2N5045	TIS25		2N4857	2N4391
2N4084	2N5045	TIS25		2N4857	2N4392
2N4085	2N5045	TIS25		2N4857	2N4393
2N4086	TIS98	TIS98		2N4252	2N4252
2N4087	TIS97	TIS97		2N4400	2N5449
2N4091	2N4857	2N4091		2N5449	2N5449
2N4092	2N4857	2N4092		2N2905	2N2904
2N4093	2N4857	2N4093		2N4403	2N2905
2N4099	2N3680	2N3680		2N4416	2N4416
2N4104	2N4104	2N4104		2N4416A	2N4416A
2N4115	2N3996	2N3996		2N4418	2N4418
2N4116	2N3996	2N3996			

CROSS-REFERENCE GUIDE BETWEEN JEDEC OR COMPETITIVE TYPE NUMBERS AND TI DEVICES (Cont'd.)

Type	Preferred TI Type	Nearest TI Type	Type	Preferred TI Type	Nearest TI Type
2N4419	2N4418	2N4419	2N5127	TIS98	TIS98
2N4420	2N4420	2N4420	2N5128	2N5451	2N5451
2N4421	2N4420	2N4421	2N5129	2N5451	2N5451
2N4422		2N4422	2N5130	2N5450	2N5450
2N4423	2N4423	2N4423	2N5131	2N5451	2N5451
2N4436	2N5449	2N5449	2N5132	2N5451	2N5451
2N4437	2N5449	2N5449	2N5133	2N5449	2N5449
2N4854	2N4854	2N4854	2N5134	2N4420	2N4420
2N4855		2N4855	2N5138	2N4061	2N4061
2N4856	2N4857	2N4856	2N5139	2N3250	2N3250
2N4856A	2N4857	2N4856A	2N5140	2N3250	2N3250
2N4857	2N4857	2N4857	2N5141	2N3829	2N3829
2N4857A	2N4857	2N4857A	2N5142	2N3829	2N3829
2N4858	2N4857	2N4858	2N5143	2N3829	2N3829
2N4858A	2N4857	2N4858A	2N5196	2N5045	2N5045
2N4859	2N4857	2N4859	2N5197	2N5045	2N5045
2N4859A	2N4857	2N4859A	2N5198	2N5045	2N5045
2N4860	2N4857	2N4860	2N5199	2N5045	2N5045
2N4860A	2N4857	2N4860A	2N5245	TIS88	TIS88
2N4861	2N4857	2N4861	2N5246	TIS88	TIS88
2N4861A	2N4857	2N4861A	2N5247	TIS88	TIS88
2N4867	2N3822	2N3821	2N5248	2N3819	2N3819
2N4867A	2N3822	2N3821	2N5273	2N5273	2N5273
2N4868	2N3822	2N3821	2N5274	2N5274	2N5274
2N4868A	2N3822	2N3821	2N5275		2N5275
2N4869	2N3822	2N3821	2N5312	2N5386	2N5386
2N4869A	2N3822	2N3821	2N5313	2N5386	2N5386
2N4874	2N4875	2N4874	2N5314	2N5386	2N5386
2N4875	2N4875	2N4875	2N5316	2N5384	2N5384
2N4876	2N4875	2N4876	2N5317	2N5384	2N5384
2N4891	2N4891	2N4891	2N5318	2N5384	2N5384
2N4892	2N4891	2N4892	2N5332		2N5332
2N4893	2N4891	2N4893	2N5333	2N5333	2N5333
2N4894	2N4891	2N4894	2N5384	2N5384	2N5384
2N4913	2N4891	2N4913	2N5385	2N5385	2N5385
2N4914		2N4914	2N5386	2N5386	2N5386
2N4915		2N4915	2N5387	2N5387	2N5387
2N4934	2N4252	2N4252	2N5388	2N5388	2N5388
2N4935	2N4252	2N4252	2N5389	2N5389	2N5389
2N4936	2N4252	2N4252			2N5390
2N4944	2N5449	2N5449	2N5390		2N5390
2N4946	2N5449	2N5449	2N5399		2N5399
2N4947	2N3980	2N4947	*2N5404	2N5384	2N5384
2N4948	2N3980	2N4948	*2N5405	2N5384	2N5384
2N4949	2N3980	2N4949	*2N5406	2N5384	2N5384
2N4951	2N5450	2N3705	*2N5407	2N5384	2N5384
2N4952	2N5499	2N3704	2N5413		2N5413
2N4954	2N5449	2N5449	2N5414		2N5414
2N4964	2N4060	2N4060	2N5417		2N5417
2N4965	2N4058	2N4058	*2N5441	2N5273	2N5273
2N4966	TIS99	TIS99	*2N5442	2N5274	2N5274
2N4967	TIS99	TIS99	*2N5444	2N5273	2N5273
2N4968	TIS99	TIS99	*2N5445	2N5274	2N5274
2N4976	2N4875	TIS99	2N5447	2N5447	2N5447
2N4977	2N4857	2N4856A	2N5448	2N5448	2N5448
2N4978	2N4857	2N4856A	2N5449	2N5449	2N5449
2N4979	2N4857	2N4856A	2N5450	2N5450	2N5450
2N4994		2N4994	2N5451	2N5451	2N5451
2N4995	2N4995	2N4995			
2N4996	2N4996	2N4996	3N34		3N34
2N4997		2N4997	3N35		3N35
2N5020	2N2386	2N2386A	3N62	3N79	3N79
2N5021	2N2386	2N2386A	3N63	3N79	3N78
2N5022	2N2386	2N2386A	3N64	3N79	3N77
2N5023	2N2386	2N2386A	3N65	3N79	3N79
2N5043	2N5043	2N5043	3N66	3N79	3N78
2N5044		2N5044	3N67	3N79	3N77
2N5045	2N5045	2N5045	3N68	3N79	3N79
2N5046	2N5045	2N5046	3N68A	3N79	3N108
2N5047	2N5045	2N5047	3N69	3N79	3N78
2N5053	2N918	2N918	3N70	3N79	3N77
2N5054	2N918	2N918	3N71	3N79	3N77
2N5055	2N3829	2N3829	3N72	3N79	3N78
2N5056	2N3829	2N3829	3N73	3N79	3N79
2N5057	2N3829	2N3829	3N74	3N79	3N74
2N5058		2N5058	3N75	3N79	3N75
2N5059		2N5059	3N76	3N79	3N76
2N5066	2N2432	2N2432	3N77	3N79	3N77
2N5078	2N4416	2N4416	3N78	3N79	3N78
2N5086	2N4058	2N4058	3N79	3N79	3N79
2N5103	2N4416	2N4416	3N87	3N79	3N77
2N5104	2N4416	2N4416	3N88	3N79	3N78
2N5105	2N4416	2N4416	3N90	3N111	3N110
2N5106		2N5399	3N91	3N111	3N110
2N5107		2N5399	3N92	3N111	3N111
2N5126	TIS98	TIS98	3N93	3N111	3N108

CROSS-REFERENCE GUIDE BETWEEN JEDEC OR COMPETITIVE TYPE NUMBERS AND TI DEVICES (Cont'd.)

Type	Preferred TI Type	Nearest TI Type	Type	Preferred TI Type	Nearest TI Type
3N94	3N111	3N108	3N117	3N111	3N110
3N95	3N111	3N109	3N118	3N111	3N110
3N100	3N111	3N108	3N119	3N111	3N110
3N101	3N111	3N108	3N120	3N111	3N111
3N102	3N111	3N108	3N121	3N111	3N111
3N103	3N111	3N108	3N123	3N111	3N111
3N104	3N111	3N108	3N124		TIXS80
3N105	3N111	3N108	3N125		TIXS80
3N106	3N111	3N108	3N126		TIXS80
3N107	3N111	3N108	3N127	3N79	3N79
3N108	3N111	3N108	3N129	3N111	3N108
3N109	3N111	3N109	3N130	3N111	3N108
3N110	3N111	3N110	3N131	3N111	3N108
3N111	3N111	3N111	3N132	3N111	3N108
3N112	3N111	3N108	3N133	3N111	3N108
3N113	3N111	3N108	3N134	3N111	3N108
3N114	3N111	3N110	3N135	3N111	3N108
3N115	3N111	3N110	3N136	3N111	3N108
3N116	3N111	3N111			

Type	Manufacturer	Preferred TI Type	Nearest TI Type	Type	Manufacturer	Preferred TI Type	Nearest TI Type
3RC2	INR		2N1600	C5G	GE		2N2325
3RC5	INR		2N1600	C5U	GE		2N2322
3RC10	INR		2N1601	C6A	GE	2N3561	2N3561
3RC15	INR		2N1602	C6B	GE	2N3562	2N3562
3RC20	INR		2N1602	C6F	GE	2N3560	2N3560
3RC25	INR		2N1603	C6G	GE	2N3562	2N3562
3RC30	INR		2N1603	C6U	GE	2N3559	2N3559
3RC40	INR		2N1604	C7A	GE	2N3557	2N3557
5RC2	INR		2N1770	C7B	GE	2N3558	2N3558
5RC5	INR		2N1771	C7F	GE	2N3556	2N3556
5RC10	INR		2N1772	C7G	GE	2N3558	2N3558
5RC15	INR		2N1773	C7U	GE	2N3555	2N3555
5RC20	INR		2N1774	C10A	GE		2N1772A
5RC25	INR		2N1775	C10B	GE		2N1774A
5RC30	INR		2N1776	C10C	GE		2N1776A
5RC40	INR		2N1777	C10D	GE		2N1777A
5RC50	INR		2N1778	C10F	GE		2N1771A
5RCL2	INR		T140A0	C10G	GE		2N1773A
5RCL5	INR		T140A0	C10H	GE		2N1775A
5RCL10	INR		T140A1	C10U	GE		2N1770A
5RCL15	INR		T140A2	C11A	GE		2N1772
5RCL20	INR		T140A2	C11B	GE		2N1774
5RCL25	INR		T140A3	C11C	GE		2N1776
5RCL30	INR		T140A3	C11D	GE		2N1777
5RCL40	INR		T140A4	C11E	GE		2N1777
10RC2	INR		2N1842B	C11F	GE		2N1771
10RC5	INR		2N1843B	C11G	GE		2N1773
10RC10	INR		2N1844B	C11H	GE		2N1775
10RC15	INR		2N1845B	C11U	GE		2N1770
10RC20	INR		2N1846B	C12A	GE		2N3936
10RC25			2N1847B	C12B	GE		2N3937
10RC30	INR		2N1848B	C12C	GE		2N3938
10RC40	INR		2N1849B	C12D	GE		2N3939
10RC50	INR		2N1850B	C12F	GE		2N3936
10RCL2	INR		2N1842B	C12G	GE		2N3937
10RCL5	INR		2N1843B	C12H	GE		2N3938
10RCL10	INR		2N1844B	C12U	GE		2N3936
10RCL15	INR		2N1845B	C15A	GE		T140A1
10RCL20	INR		2N1846B	C15B	GE		T140A2
10RCL30	INR		2N1848B	C15C	GE		T140A3
10RCL40	INR		2N1849B	C15D	GE		T140A4
16RC2	INR		2N1842B	C15F	GE		T140A0
16RC5	INR		2N1843B	C15G	GE		T140A2
16RC10	INR		2N1844B	C15U	GE		T140A0
16RC15	INR		2N1845B	C20A	GE		T140A1
16RL20	INR		2N1846B	C20B	GE		T140A2
16RL25	INR		2N1847B	C20C	GE		T140A3
16RL30	INR		2N1848B	C20D	GE		T140A4
16RL40	INR		2N1849B	C20F	GE		T140A0
16RL50	INR		2N1850B	C20U	GE		T140A0
40598	RCA		TIXL09	C36A	GE		2N1844B
C5A	GE		2N2324	C36B	GE		2N1846B
C5B	GE		2N2326				
C5F	GE		2N2323				

KEY TO MANUFACTURERS

ECC — Electronic Control Corporation
 FSC — Fairchild Semiconductor Corporation
 GE — General Electric Company
 GSI — General Sensors, Incorporated
 HPA — Hewlett-Packard Associates
 HUDSON — Hudson Electronics

INR — International Rectifier Corporation
 MOTA — Motorola Semiconductor Products, Incorporated
 RAYN — Raytheon Semiconductor Division
 RCA — Radio Corporation of America
 SOD — Solitron Devices, Incorporated
 TEC — Transitron Electronic Corporation

CROSS REFERENCE GUIDE BETWEEN COMPETITIVE DEVICES AND TI DEVICES (Cont'd.)

Type	Manufacturer	Preferred TI Type	Nearest TI Type	Type	Manufacturer	Preferred TI Type	Nearest TI Type
C36C	GE		2N1848B	MPS6542	MOTA	TIS62	TIS62
C36D	GE		2N1849B	MPS6543	MOTA	TIS86	TIS86
C36E	GE		2N1850B	MPS6544	MOTA	TIS87	TIS87
C36F	GE		2N1843B	MPS6545	MOTA	TIS87	TIS87
C36G	GE		2N1845B	MPS6546	MOTA	TIS86	TIS86
C36H	GE		2N1847B	MPS6547	MOTA	TIS86	TIS86
C36U	GE		2N1842B	MPS6552	MOTA	TIS98	TIS98
C37A	GE		2N1844B	MPS6553	MOTA	TIS97	TIS97
C37B	GE		2N1846B	MPS6554	MOTA	TIS97	TIS97
C37C	GE		2N1848B	MPS6555	MOTA	TIS97	TIS97
C37D	GE		2N1849B	MPS6560	MOTA	TIS92	TIS92
C37E	GE		2N1850B	MPS6561	MOTA	TIS92	TIS92
C37F	GE		2N1843B	MPS6562	MOTA	TIS93	TIS93
C37U	GE		2N1842B	MPS6563	MOTA	TIS93	TIS93
ER900	TEC	TI43A	TI43A	MPS6564	MOTA		2N4994
FK918	FSC		A3T918	MPS6565	MOTA	TIS99	TIS99
FK2484	FSC		A3T2484	MPS6566	MOTA	TIS98	TIS98
FLB100	FSC		TIL01	MPS6567	MOTA	TIS86	TIS86
FPD100	FSC	LS600	LS600	MPS6579	MOTA	TIS37	TIS37
FPM100	FSC	LS600	LS600	MRD200	MOTA	LS600	LS600
FPM200	FSC	1N2175	1N2175	MRD300	MOTA	LS600	LS600
FPT100	FSC	LS600	LS600	Q2040	ECC	2N5273	2N5273
FV918	FSC		A3T918	Q3040	ECC	2N5274	2N5274
FV2484	FSC		A3T2484	Q4040	ECC	2N5274	2N5274
FW2894	FSC		A3T2894	Q6040	ECC		2N5275
FW2484	FSC		A3T2484	Q6540	ECC		2N5275
GA1	RAYN		TIXL03	SDT6905-6908	SOD	2N3421	2N3421
GA2	RAYN		TIXL03	SDT8105-8116	SOD		2N4004
GS600	GSI	LS600	LS600	SDT8801-8805	SOD		2N3846
HI6820	HUDSON	LS400	LS400	SDT9901-9904	SOD	2N4301	2N4301
HP4107	HPA		TIL01	SE1001	FSC		2N4994
HP4120	HPA		TIXL10	SE1002	FSC		2N4995
HP4205	HPA		LSX900	SE2001	FSC	TIS98	TIS98
HP4220	HPA		TIXL51-2	SE2002	FSC	2N5449	2N5449
HP4309	HPA		TIXL101	SE3001	FSC	TIS62	TIS62
HP4310	HPA		TIXL102-3	SE3002	FSC	TIS62	TIS62
MHM2001-2017	SOD		2N5390	SE4001	FSC	TIS97	TIS97
MHM2101-2117	SOD		2N5390	SE4002	FSC	TIS97	TIS97
MHM2201-2217	SOD		2N5390	SE4010	FSC	TIS97	TIS97
MHT4551-4583	SOD		2N2151	SE5020	FSC	TIS84	TIS84
MHT5501-5508	SOD	2N4300	2N4300	SE5021	FSC	TIS85	TIS85
MHT6408-6416	SOD	2N4301	2N3996	SE5022	FSC	TIS85	TIS85
MHT7011-7019	SOD	2N3996	2N4301	SE5023	FSC	TIS85	TIS85
MHT7401-7419	SOD	2N3421	2N3421	SE5024	FSC	TIS85	TIS85
MHT7801-7809	SOD	2N5387	2N5387	SE7001	FSC		TIXS100
MHT8002-8304	SOD	2N4002	2N4002	SE7002	FSC		TIXS100
MHT9001-9012	SOD	2N4002	2N4002	ST2	GE	TI43A	TI43A
MPS918	MOTA	TIS62	TIS62	TA2314	RCA		2N3847
MPS2923	MOTA	TIS99	TIS99	TCR3	TEC		2N1600
MPS2924	MOTA	TIS98	TIS98	TCR8	TEC		TI40A0
MPS2925	MOTA	TIS98	TIS98	TCR13	TEC		2N1601
MPS3563	MOTA	TIS62	TIS62	TCR18	TEC		TI40A1
MPS6506	MOTA	TIS86	2N4996	TCR23	TEC		2N1602
MPS6507	MOTA	TIS86	2N4996	TCR28	TEC		TI40A2
MPS6508	MOTA	TIS86	2N4996	TCR33	TEC		2N1603
MPS6509	MOTA	TIS84	TIS84	TCR35C	TEC		TI145A0
MPS6510	MOTA	TIS84	TIS84	TCR38	TEC		TI40A3
MPS6511	MOTA	TIS87	TIS87	TCR40C	TEC	2N3559	2N3559
MPS6512	MOTA	TIS99	TIS99	TCR41C	TEC	2N3559	2N3559
MPS6513	MOTA	TIS99	TIS99	TCR42C	TEC	2N3560	2N3560
MPS6514	MOTA	TIS98	TIS98	TCR43	TEC		2N1604
MPS6515	MOTA	TIS97	TIS97	TCR43C	TEC	2N3561	2N3561
MPS6516	MOTA	2N5447	2N5447	TCR44C	TEC	2N3562	2N3562
MPS6517	MOTA	2N5447	2N5447	TCR45C	TEC	2N3562	2N3562
MPS6518	MOTA	2N5447	2N5447	TCR48	TEC	2N3562	
MPS6519	MOTA	2N5447	2N5447	TCR65C	TEC		TI40A4
MPS6520	MOTA	TIS98	TIS98	TCR105C	TEC		TI145A0
MPS6521	MOTA	TIS97	TIS97	TCR205C	TEC		TI145A1
MPS6522	MOTA	2N5447	2N5447	TCR305C	TEC		TI145A2
MPS6523	MOTA	2N5447	2N5447	TCR405C	TEC		TI145A3
MPS6528	MOTA	TIS84	TIS84		TEC		TI145A4
MPS6529	MOTA	TIS85	TIS85	TCR730	TEC		TI40A0
MPS6530	MOTA	TIS92	TIS92	TCR731	TEC		TI40A1
MPS6531	MOTA	TIS92	TIS92	TCR732	TEC		TI40A2
MPS6532	MOTA	TIS92	TIS92	TCR733	TEC		TI40A3
MPS6533	MOTA	TIS93	TIS93	TCR734	TEC		TI40A4
MPS6534	MOTA	TIS93	TIS93	TT500	TEC	2N3560	2N3560
MPS6535	MOTA	TIS93	TIS93	TT501	TEC	2N3561	2N3561
MPS6541	MOTA	TIS86	2N4996	TT502	TEC	2N3562	2N3562

KEY TO MANUFACTURERS

ECC — Electronic Control Corporation
 FSC — Fairchild Semiconductor Corporation
 GE — General Electric Company
 GSI — General Sensors, Incorporated
 HPA — Hewlett-Packard Associates
 HUDSON — Hudson Electronics

INR — International Rectifier Corporation
 MOTA — Motorola Semiconductor Products, Incorporated
 RAYN — Raytheon Semiconductor Division
 RCA — Radio Corporation of America
 SOD — Solitron Devices, Incorporated
 TEC — Transitron Electronic Corporation

**INDEX TO ALL STANDARD DISCRETE
SEMICONDUCTORS AND COMPONENTS MANUFACTURED
BY TEXAS INSTRUMENTS**

(Preferred Devices in Bold Type)

Devices shown below represent the entire line of TI standard discrete semiconductors arranged in strict numerical order disregarding prefix.

Example: LSX900

A905-A908 (A900) (parentheses indicate first device listed on data sheet)

2N910-2N912

1N914-1N917

DEVICE TYPE	PAGE/CODE	DEVICE TYPE	PAGE/CODE
CD 1/8 R	SCC	TID31-TID37	SCC
CG 1/8	28201	TIP31	16109
CR 1/8	SCC	TIP31A (TIP31)	16109
TC 1/8 (TM 1/8)	29003	TIP32	16113
TG 1/8	29001	TIP32A (TIP32)	16113
TM 1/8	29003	TIP33	16117
CD 1/4 R (CD 1/8 R)	SCC	TIP33A (TIP33)	16117
CG 1/4 (CG 1/8)	28201	TIXS33	NR
CR 1/4 (CR 1/8)	SCC	3N34	SCC
TM 1/4 (TM 1/8)	29003	TIP34	16121
CD 1/2 MR (CD 1/8 R)	SCC	TIP34A (TIP34)	16121
CD 1/2 PR (CD 1/8 R)	SCC	TIS34	SCC
CD 1/2 SR (CD 1/8 R)	SCC	3N35	SCC
CG 1/2 (CG 1/8)	28201	H35 (H11)	SCC
CR 1/2 (CR 1/8)	SCC	TIP35	16125
CD 1 R (CD 1/8 R)	SCC	TIP35A (TIP35)	16125
G01	CSO	TIXS35-TIXS36	SCC
TIL01	SCC	TIP36	16129
TIXV01-TIXV04	SCC	TIP36A (TIP36)	16129
CD 2 R (CD 1/8 R)	SCC	TIS37-TIS38	2001
G02	CSO	H38 (H11)	SCC
TIXL02	NR	TIS39 (Same as TIXS39)	SCC
TIXL03	SCC	TIXS39	SCC
TIS05	NR	TI40A0-TI40A4	SCC
TIXL05-TIXL06	SCC	TID40-TID44	SCC
TIXV05-TIXV07	SCC	TI42A-TI43A	24105
TIXL08	SCC	TIS42	SCC
TIXV08-TIXV19	SCC	TIS43	SCC
TIXL09	SCC	TIC44-TIC47	24109
TIXL10	SCC	TIS44(706)	SCC
H11	SCC	TIS45(708)	SCC
TIXM12	SCC	TIS46(914)	SCC
TIXS12-TIXS13	SCC	TIS47(2368)-TIS48(2369)	SCC
TIS14	SCC	TIS49(2369A)	SCC
TIXM14-TIXM17	SCC	TIS50(2894)	SCC
TID17-TID20	SCC	TI51-TI60	SCC
TIS18	SCC	TIS51(3011)	SCC
TIC20-TIC23	24101	TIXL51-TIXL53	SCC
TID21-TID24	20005	TIS52(3014)	SCC
TIS22-TIS24	SCC	TIS53(3639)-TIS54(3640)	SCC
TID25-TID26	20009	TIC54-TIC57 (TI42A)	24105
TIS25-TIS27	SCC	TIXL54	SCC
TID29-TID30	20013	MC55	28401
TIP29	16101	MC55D (MC55)	28401
TIP29A (TIP29)	16101	TIS55(3646)	SCC
TIP30	16105	TIXL55-TIXL56	SCC
TIP30A (TIP30)	16105	TIS56-TIS57	1021

Explanation of Page/Code column:

Page Number — Page number in this catalog of data sheet for device listed at left.
 SCC — Data sheet in 1967-68 Semiconductors and Components Catalog — data sheet available on request.
 CSO — Data sheet not presently available; contact TI sales office.
 NR — Not recommended for new design; data sheet available on request.
 R — Data sheet available on request.

DEVICE TYPE	PAGE/CODE	DEVICE TYPE	PAGE/CODE
TIXL57	SCC	300	
TIS58-TIS59	SCC	TIXM301	SCC
H60-H62 (H11)	SCC	TIXV304	SCC
MC60 (MC55)	28401	TIV305	SCC
MC60D (MC55)	28401	TIV306-TIV308	21205
MM60	SCC	2N315A	CSO
TIS60-TIS61	SCC	2N317A	CSO
TIS60M-TIS61M (TIS60)	SCC	2N327A-2N329A	SCC
TIS62, TIS63, TIS64	1025	1N332-1N349	CSO
MC65 (MC55)	28401	2N332	SCC
MC65D (MC55)	28401	2N332A	CSO
MM65 (MM60)	SCC	2N333	SCC
TIXS67	SCC	2N333A	CSO
TIS68, TIS69, TIS70	6101	2N334	SCC
MM70 (MM60)	SCC	2N334A	CSO
TI71-TI75	CSO	2N335	SCC
TIS71-TIS72	SCC	2N335A	CSO
TIS73-TIS75	6103	2N336	SCC
3N74-3N79	4101	2N336A	CSO
TIS78-TIS79	SCC	2N337	SCC
TIXS80-TIXS81	SCC	2N338	SCC
TIS82	SCC	2N339-2N343	SCC
TIS83	SCC	2N342A (2N339)	SCC
TIS84-TIS85	1033	TI363-TI364	NR
TIS86-TIS87	1041	TI365	CSO
TIS88	6111	2N377	CSO
TIS90, TIS91, TIS92, TIS93	4105	2N388	SCC
TIS90M, TIS91M, TIS92M,		2N388A (2N388)	SCC
TIS93M (TIS90)	4105	TI388-TI391	CSO
TIS94, TIS95, TIS96, TIS97,		2N389	SCC
TIS98, TIS99	1047	2N389A	CSO
100		2N395-2N397	NR
P100 Probe (TM 1/8)	29003	TI395	CSO
TIXS100-TIXS101	CSO	TI397-TI398	CSO
TIXL101	SCC	2N398	9101
TIXM101	SCC	2N398A (2N398)	9101
TIXL102-TIXL103	SCC	2N398B (2N398)	9101
TIXS102-TIXS103	CSO	TI399	CSO
TIXM103-TIXM104	SCC	400	
TIXL104-TIXL106	CSO	LS400	27401
TIXM105-TIXM106	SCC	TI400-TI403	SCC
TIXM107-TIXM108	SCC	2N404	9105
3N108-3N111	4109	2N404A (2N404)	9105
2N117	SCC	TI407-TI409	SCC
2N118	SCC	2N424 (2N389)	SCC
2N118A	SCC	2N424A	CSO
2N119	SCC	2N426-2N428	SCC
2N120	SCC	2N438	CSO
2N122	SCC	2N438A	CSO
G129	SCC	2N439-2N440	CSO
G130	SCC	1N440B-1N445B	CSO
TI145A0-TI145A4	SCC	1N456, 1N457, 1N458, 1N459	18101
TI156	SCC	1N456A-1N459A	CSO
TI156L (TI156)	SCC	2N456A-2N458A	17101
TI158 (TI156)	SCC	2N456B-2N458B	SCC
TI158A (TI156)	SCC	1N461-1N464	SCC
TI158AL (TI156)	SCC	1N461A	CSO
TI158L (TI156)	SCC	2N470-2N480	CSO
TI159-TI162	SCC	TI480-TI481	SCC
200		1N482-1N485	18105
2N243-2N244	SCC	1N482A-1N485A	CSO
2N250	NR	1N482B-1N485B	CSO
2N250A-2N251A	SCC	TI482	SCC
1N251	SCC	TI483-TI484	SCC
2N251	NR	TI485	CSO
1N253-1N256	CSO	TI486-TI487	SCC
2N263-2N264	CSO	2N489-2N494	7101

Explanation of Page/Code column:

Page Number — Page number in this catalog of data sheet for device listed at left.
 SCC — Data sheet in 1967-68 Semiconductors and Components Catalog — data sheet available on request.
 CSO — Data sheet not presently available; contact TI sales office.
 NR — Not recommended for new design; data sheet available on request.
 R — Data sheet available on request.

DEVICE TYPE	PAGE/CODE	DEVICE TYPE	PAGE/CODE
2N489A, 2N490A, 2N491A, 2N492A, 2N493A, 2N494A (2N489)	7101	1N645A (1N645)	18109
2N489B-2N494B (2N489)	7101	2N650A-2N652A	NR
T1492	SCC	650-653	SCC
T1493-T1495	SCC	650C0-650C7 (650)	SCC
2N494C	CSO	651C0-651C9 (650)	SCC
T1496	SCC	652C0-652C9 (650)	SCC
2N497-2N498	SCC	653C0-653C9 (650)	SCC
2N497A-2N498A	CSO	654C9 (650)	SCC
500		655C9 (650)	SCC
LS500	CSO	2N656-2N657 (2N497)	SCC
XD500-XD502	SCC	2N656A-2N657A	CSO
2N508	CSO	1N658	CSO
2N511	SCC	2N658-2N662	NR
2N511A (2N511)	SCC	1N659-1N661	SCC
2N511B (2N511)	SCC	1N662-1N663	SCC
2N512	SCC	2N681-2N688	SCC
2N512A (2N512)	SCC	2N681A-2N689A	SCC
2N512B (2N512)	SCC	2N689	CSO
2N513	SCC	2N696-2N697	1201
2N513A (2N513)	SCC	2N698-2N699	1209
2N513B (2N513)	SCC	700	
2N514	SCC	1N702-1N707	SCC
2N514A (2N514)	SCC	1N702A 1N707A (1N702)	SCC
2N514B (2N514)	SCC	2N702	NR
A516-A517	SCC	2N703	NR
2N520	CSO	2N705	NR
2N520A	CSO	A706-A713	SCC
2N522A	CSO	2N706	CSO
2N524-2N527	SCC	2N706A	SCC
1N530-1N540	CSO	2N706B	CSO
T1539-T1540	NR	1N708-1N716	SCC
A543	CSO	1N708A-1N716A (1N708)	SCC
2N541-2N543	CSO	2N708	SCC
1N547	CSO	2N709	SCC
1N550-1N555	CSO	2N710	CSO
T1550-T1551	SCC	2N711	NR
2N581-2N582	CSO	2N711A	SCC
2N587	CSO	2N711B (2N711A)	SCC
2N594-2N596	NR	2N715-2N716	CSO
1N599	CSO	2N717-2N718 (2N696)	1201
1N599A	CSO	2N718A (2N696)	1201
600		2N719-2N720 (2N698)	1209
600C-601C	SCC	2N719A-2N720A (2N698)	1209
1N600-1N606	CSO	2N721-2N722	CSO
1N600A-1N606A	CSO	2N726-2N727	SCC
A600-A602	SCC	2N730-2N731 (2N696)	1201
LS600	27501	2N734	CSO
604C (600C)	SCC	2N735	SCC
606C (600C)	SCC	2N736	SCC
1N607-1N614	CSO	2N736A	SCC
1N607A-1N614A	CSO	2N738	NR
608C (600C)	SCC	2N739	SCC
610C (600C)	SCC	2N740	SCC
A610-A612	SCC	2N743-2N744	SCC
612C (600C)	SCC	1N746-1N759	23109
614C (600C)	SCC	1N746A-1N759A (1N746)	23109
616C (600C)	SCC	2N753 (2N706A)	SCC
618C (600C)	SCC	2N759	SCC
620C (600C)	SCC	2N759A (2N759)	SCC
622C (600C)	SCC	2N760	SCC
624C (600C)	SCC	2N760A (2N760)	SCC
1N625-1N629	SCC	1N761-1N766	SCC
2N634A-2N636A	CSO	2N780	SCC
1N643	SCC	2N797	12101
1N645-1N649	18109	800	
		2N849-2N850	SCC
		2N851-2N852	SCC

Explanation of Page/Code column:

Page Number — Page number in this catalog of data sheet for device listed at left.

SCC — Data sheet in 1967-68 Semiconductors and Components Catalog — data sheet available on request.

CSO — Data sheet not presently available; contact TI sales office.

NR — Not recommended for new design; data sheet available on request.

R — Data sheet available on request.

DEVICE TYPE	PAGE/CODE	DEVICE TYPE	PAGE/CODE
2N870-2N871 (2N698)	1209	1300	
2N876-2N881	SCC	2N1302-2N1309	9205
2N884-2N888	SCC	2N1319	CSO
2N889	CSO	2N1370-2N1371 (2N1273)	SCC
900		2N1372-2N1377	9213
A900-A903	SCC	2N1378-2N1381 (2N1372)	9213
LSX900	SCC	2N1382-2N1383	NR
A905-A908 (A900)	SCC	2N1385	CSO
2N910-2N912	SCC	1400	
1N914-1N917	19201	2N1404	CSO
2N914	SCC	2N1413-2N1415	SCC
1N914A (1N914)	19201	2N1420 (2N696)	1201
1N914B (1N914)	19201	2N1445	CSO
2N915	SCC	1N1487-1N1492	CSO
2N916	SCC	1500	
1N916A (1N914)	19201	2N1507 (2N696)	1201
1N916B (1N914)	19201	2N1529-2N1538	CSO
2N917	SCC	2N1539-2N1543	17223
2N918	3201	2N1544-2N1548	CSO
A3T918	CSO	2N1564	NR
2N929-2N930	1269	2N1565	SCC
A3T929-A3T930	CSO	2N1566	SCC
2N929A-2N930A	CSO	2N1566A (2N736A)	SCC
2N956 (2N696)	1201	2N1572	NR
1N957-1N961	CSO	2N1573	SCC
1N957A-1N961A	CSO	2N1574	SCC
1N957B-1N961B	CSO	1N1581-1N1587	CSO
2N960-2N962	12105	2N1586-2N1594	CSO
2N963	SCC	2N1595-2N1599	SCC
2N964-2N966 (2N960)	12105	1600	
2N967 (2N963)	SCC	2N1600-2N1604	SCC
2N968-2N975	SCC	2N1605	SCC
2N985	SCC	1N1612-1N1616	CSO
2N995	SCC	2N1613 (2N696)	1201
2N997	4301	2N1671	7109
1000		2N1671A (2N1671)	7109
NP1000-NP1001 (Solar Cells)	SCC	2N1671B (2N1671)	7109
2N1021-2N1022 (2N456A)	17101	2N1690-2N1691	CSO
2N1021A-2N1022A (2N456B)	SCC	1N1692-1N1697	CSO
2N1038-2N1041	17201	1700	
2N1042-2N1045	SCC	2N1711 (2N696)	1201
2N1046	SCC	2N1714-2N1721	SCC
2N1047-2N1050	SCC	2N1722	16301
2N1047A-2N1050A	CSO	2N1722A	SCC
2N1047B-2N1050B	SCC	2N1723	SCC
1N1095-1N1096	CSO	2N1724 (2N1722)	16301
1100		2N1724A (2N1722A)	SCC
1N1100-1N1105	CSO	2N1725 (2N1723)	SCC
1N1115-1N1120	CSO	2N1729-2N1732	CSO
T11121-T11126	SCC	2N1770-2N1778	SCC
1N1124A-1N1128A	CSO	2N1770A-2N1777A	SCC
2N1131-2N1132	SCC	1800	
T11131-T11136	SCC	2N1808 (2N1605)	SCC
2N1141-2N1143	SCC	1N1816-1N1836	CSO
2N1141A-2N1143A	CSO	1N1816A-1N1836A	CSO
T11141-T11146	SCC	1N1816C-1N1836C	CSO
2N1149-2N1153	SCC	1N1816CA-1N1836CA	CSO
T11151-T11156	SCC	2N1842B-2N1850B	SCC
2N1154-2N1156	SCC	2N1889-2N1890 (2N698)	1209
2N1195	CSO	2N1891-2N1892	CSO
1200		2N1893 (2N698)	1209
2N1235	CSO	1900	
2N1252	SCC	2N1907-2N1908	17231
2N1253	SCC	2N1924-2N1926	SCC
2N1260	CSO	2N1973-2N1975 (2N910)	SCC
2N1273-2N1274	SCC	2N1993	CSO
2N1276-2N1279	CSO	2N1994-2N1996	SCC

Explanation of Page/Code column:

Page Number — Page number in this catalog of data sheet for device listed at left.
 SCC — Data sheet in 1967-68 Semiconductors and Components Catalog — data sheet available on request.
 CSO — Data sheet not presently available; contact TI sales office.
 NR — Not recommended for new design; data sheet available on request.
 R — Data sheet available on request.

DEVICE TYPE	PAGE/CODE	DEVICE TYPE	PAGE/CODE
2N1997-2N1999	9301	2N2653	R
2000		2N2659-2N2670	SCC
NP2000-NP2001 (Solar Cells)	SCC	2N2687-2N2690	SCC
2N2000-2N2001	9307	2N2692-2N2694	SCC
1N2008-1N2012	CSO	2N2695-2N2696	SCC
1N2008A-1N2012A	CSO	2800	
1N2008C-1N2012C	CSO	2N2802-2N2807	SCC
1N2008CA-1N2012CA	CSO	2N2861-2N2862	R
2N2060	4401	2N2863-2N2864	SCC
1N2069-1N2071	SCC	2N2865	SCC
1N2069A-1N2071A (1N2069)	SCC	2N2883-2N2884	SCC
2100		2N2894	2125
2N2102	CSO	A3T2894	CSO
2N2102A	CSO	2900	
2N2150-2N2151	SCC	2N2902	CSO
2N2160 (2N1671)	7109	2N2904, 2N2905, 2N2906, 2N2907	2127
2N2173	CSO	2N2904A-2N2907A	SCC
1N2175	27801	A3T2906-A3T2907	CSO
2N2188-2N2191	SCC	A3T2906A-A3T2907A	CSO
2N2192-2N2194	1301	2N2913-2N2920	SCC
2N2192A-2N2194A (2N2192)	1301	2N2944-2N2946	2131
2200		2N2944A, 2N2945A,	
2N2217-2N2219	1305	2N2946A (2N2944)	2131
2N2218A-2N2219A	SCC	1N2970-1N3011	CSO
2N2220-2N2222	1305	1N2970A-1N3011A	CSO
A3T2221-A3T2222	CSO	1N2970B-1N3011B	CSO
2N2221A-2N2222A (2N2218A)	SCC	2N2987-2N2994	16401
A3T2221A-A3T2222A	CSO	2N2996	SCC
2N2223 (2N2060)	4401	2N2997	SCC
2N2223A (2N2060)	4401	2N2998	NR
2N2243 (2N2192)	1301	2N2999	NR
2N2243A (2N2192)	1301	3000	
2N2270	CSO	NP3000 (Solar Cells)	SCC
2300		2N3001-2N3004	24401
2N2303	SCC	2N3005-2N3008	24407
2N2322-2N2326	CSO	2N3009	NR
2N2368-2N2369	SCC	2N3010	1401
2N2369A	1315	2N3011	SCC
2N2386	6301	A3T3011	CSO
2N2386A	CSO	2N3012 (2N2894)	2125
2N2387-2N2388	SCC	2N3013	1405
2N2389-2N2390	SCC	2N3014	SCC
2N2393-2N2394	SCC	2N3015	1409
2N2395-2N2396	SCC	T13027-T13028	17301
2400		T13029-T13031	SCC
2N2410	SCC	2N3033-2N3035	SCC
2N2411-2N2412	SCC	2N3036	SCC
2N2413	CSO	2N3037-2N3038	SCC
2N2415-2N2416	SCC	2N3039-2N3040	SCC
2N2432	1325	2N3043-2N3044	4501
2N2432A (2N2432)	1325	2N3045-2N3048 (2N3043)	4501
2N2453	SCC	2N3049, 2N3050, 2N3051	4503
2N2481	SCC	2N3052	SCC
2N2483-2N2484	1337	2N3053	CSO
A3T2484	CSO	2N3055	16409
2N2497, 2N2498, 2N2499	6303	1N3064	19301
2500		1N3070	19303
2N2500 (2N2497)	6303	3100	
2N2537-2N2540	SCC	2N3114	SCC
2N2552-2N2559 (2N1038)	17201	2N3117	SCC
2N2560-2N2567 (2N1042)	SCC	2N3146-2N3147	SCC
2N2586	SCC	3200	
2600		2N3244-2N3245	2203
2N2604-2N2605	2119	2N3250-2N3251	2209
2N2635	12301	2N3250A-2N3251A (2N3250)	2209
2N2639-2N2641	4405	2N3252-2N3253	SCC
2N2642, 2N2643, 2N2644 (2N2639)	4405	2N3267	CSO

Explanation of Page/Code column:

Page Number — Page number in this catalog of data sheet for device listed at left.
 SCC — Data sheet in 1967-68 Semiconductors and Components Catalog — data sheet available on request.
 CSO — Data sheet not presently available; contact TI sales office.
 NR — Not recommended for new design; data sheet available on request.
 R — Data sheet available on request.

DEVICE TYPE	PAGE/CODE	DEVICE TYPE	PAGE/CODE
3300		2N3980	7201
2N3303	SCC	2N3993-2N3994	6501
2N3304	2211	2N3995	SCC
2N3328	NR	2N3996-2N3999	16601
2N3329,2N3330, 2N3331, 2N3332	6305	4000	
2N3333-2N3336	SCC	2N4000-2N4001	16607
2N3347-2N3350	4507	1N4001-1N4007	25401
2N3351-2N3352 (2N3347)	4507	2N4002-2N4003	16613
2N3371	SCC	2N4004-2N4005	SCC
2N3375	SCC	2N4030-2N4033	CSO
3400		2N4040-2N4041	CSO
2N3418-2N3421	16501	2N4058-2N4060	2301
2N3444	SCC	2N4061-2N4062 (2N4058)	2301
2N3449	CSO	2N4091-2N4093	SCC
2N3467-2N3468 (2N3244)	2203	1N4099	SCC
2N3485-2N3486	2213	4100	
2N3485A-2N3486A (2N3485)	2213	1N4100-1N4106	SCC
2N3494, 2N3495, 2N3496, 2N3497	2215	2N4104	1501
3500		2N4138 (2N2432)	1325
2N3502-2N3505	SCC	1N4148-1N4149	19401
1N3506-1N3520	CSO	1N4151-1N4154	SCC
2N3551-2N3552	16507	4200	
2N3553	CSO	2N4252-2N4253	1503
2N3554	SCC	2N4254-2N4255	1511
2N3555-2N3558	24417	4300	
2N3559-2N3562	24425	2N4300	16625
2N3570-2N3572	3401	2N4301	16631
2N3573-2N3575	CSO	1N4305	19405
2N3576	SCC	1N4360	CSO
3600		1N4370-1N4372	23601
2N3632	SCC	1N4370A-1N4372A (1N4370)	23601
2N3680	4509	1N4373	CSO
3700		1N4378	CSO
2N3702-2N3703	SCC	2N4391-2N4393	SCC
2N3704-2N3706	SCC	4400	
2N3707-2N3711	1431	2N4416	6503
2N3712	NR	2N4416A (2N4416)	6503
2N3713-2N3716	16511	2N4418-2N4419	1519
2N3724-2N3725	1433	2N4420-2N4421	1521
2N3724A-2N3725A (2N3724)	1433	2N4422	SCC
2N3733	CSO	2N4423	2303
2N3771-2N3772	CSO	1N4444 (1N4305)	19405
2N3798-2N3799	SCC	1N4446, 1N4447, 1N4448, 1N4449 (1N4148)	19401
3800		1N4454 (1N4305)	19405
2N3806-2N3811	SCC	4500	
2N3819	6401	1N4531-1N4534	19407
2N3820	6403	1N4536 (1N4531)	19407
2N3821-2N3822	6405	4600	
A3T3821-A3T3823	CSO	1N4606	SCC
2N3823	6407	4700	
2N3824	SCC	1N4727	SCC
2N3826-2N3827	1441	4800	
2N3828	NR	2N4854-2N4855	4701
2N3829	2235	2N4856-2N4857	6511
2N3830-2N3831	SCC	2N4858-2N4861 (2N4856)	6511
2N3832	SCC	2N4856A-2N4861A	SCC
2N3833-2N3835	SCC	2N4874, 2N4875, 2N4876	3701
2N3838	4517	2N4891-2N4894	7301
2N3846-2N3847	CSO	4900	
2N3866	3501	2N4913-2N4915	CSO
3900		1N4938	CSO
2N3909	6413	2N4947-2N4949 (2N3980)	7201
2N3909A	CSO	2N4994-2N4995 (2N3826)	1441
2N3936-2N3940	SCC	2N4996-2N4997 (2N4254)	1511
2N3962-2N3964	2241	5000	
2N3965 (2N3962)	2241	2N5043-2N5044	14401
2N3970-2N3972	SCC		

Explanation of Page/Code column:

Page Number — Page number in this catalog of data sheet for device listed at left.
 SCC — Data sheet in 1967-68 Semiconductors and Components Catalog — data sheet available on request.
 CSO — Data sheet not presently available; contact TI sales office.
 NR — Not recommended for new design; data sheet available on request.
 R — Data sheet available on request.

DEVICE TYPE	PAGE/CODE
2N5045-2N5047	6601
2N5058-2N5059	SCC
5200	
2N5245-2N5247	CSO
2N5248	CSO
2N5273, 2N5274, 2N5275	24601
5300	
2N5332	CSO
2N5333	16701
2N5384-2N5385	16707
2N5386	16711
2N5387-2N5389	16715
2N5390	SCC
2N5399	CSO
5400	
2N5413-2N5414	CSO
2N5417	CSO
2N5447-2N5448	2305
2N5449-2N5451	1701
MISC.	
ECM	SCC
N on P Silicon Solar Cells	SCC
SCM	30201
XMST	SCC

Explanation of Page/Code column:

- Page Number — Page number in this catalog of data sheet for device listed at left.
- SCC — Data sheet in 1967-68 Semiconductors and Components Catalog — data sheet available on request.
- CSO — Data sheet not presently available; contact TI sales office.
- NR — Not recommended for new design; data sheet available on request.
- R — Data sheet available on request.

TYPES TIS56 AND TIS57 N-P-N PLANAR SILICON TRANSISTORS



TYPES TIS56 AND TIS57
BULLETIN NO. DI-S 668628, APRIL 1966

**ESPECIALLY DESIGNED FOR TELEVISION AND VHF COMMUNICATIONS APPLICATIONS
REQUIRING HIGH GAIN AND FORWARD AGC**

- Low Capacitance... 0.32 pF Max
- AGC Operation Guaranteed at 45 Mc/s and 200 Mc/s

mechanical data

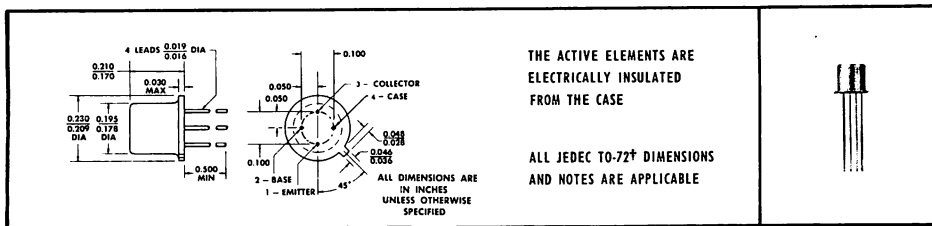

THE ACTIVE ELEMENTS ARE
ELECTRICALLY INSULATED
FROM THE CASE

ALL JEDEC TO-72† DIMENSIONS
AND NOTES ARE APPLICABLE

†TO-72 outline is same as TO-18 outline with the addition of a fourth lead.

absolute maximum ratings at 25°C free-air temperature (unless otherwise noted)

Collector-Base Voltage	30 V
Collector-Emitter Voltage (See Note 1)	20 V
Emitter-Base Voltage	3 V
Continuous Collector Current	30 mA
Continuous Device Dissipation at (or below) 25°C Free-Air Temperature (See Note 2)	200 mW
Storage Temperature Range	-65°C to 200°C
Lead Temperature 1/8 Inch from Case for 10 Seconds	300°C

- NOTES: 1. This value applies when the base-emitter diode is open-circuited.
2. Derate linearly to 175°C free-air temperature at the rate of 1.33 mW/deg.



TEXAS INSTRUMENTS
INCORPORATED
POST OFFICE BOX 5012 • DALLAS, TEXAS 75222

TYPES TIS56 AND TIS57

N-P-N PLANAR SILICON TRANSISTORS

electrical characteristics at 25°C free-air temperature

PARAMETER	TEST CONDITIONS†	MIN TYP MAX			UNIT
		MIN	TYP	MAX	
$V_{(BR)CBO}$ Collector-Base Breakdown Voltage	$I_C = 100 \mu A, I_E = 0$	30			V
$V_{(BR)CEO}$ Collector-Emitter Breakdown Voltage	$I_C = 2 \text{ mA}, I_B = 0, \text{ See Note 3}$	20			V
$V_{(BR)EBO}$ Emitter-Base Breakdown Voltage	$I_E = 100 \mu A, I_C = 0$	3			V
I_{CBO} Collector-Cutoff Current	$V_{CB} = 10 \text{ V}, I_E = 0$		50		nA
h_{FE} Static Forward Current Transfer Ratio	$V_{CE} = 10 \text{ V}, I_C = 4 \text{ mA}$	20			
$V_{CE(sat)}$ Collector-Emitter Saturation Voltage	$I_B = 5 \text{ mA}, I_C = 10 \text{ mA}$		1	3	V
$ h_{fe} $ Small-Signal Common-Emitter Forward Current Transfer Ratio	$V_{CE} = 10 \text{ V}, I_C = 4 \text{ mA}, f = 100 \text{ Mc/s}$	5	9	14	
	$V_{CE} = 10 \text{ V}, I_C = 4 \text{ mA}, f = 45 \text{ Mc/s}$		20		
C_{cb} Collector-Base Capacitance	$V_{CB} = 10 \text{ V}, I_E = 0, f = 1 \text{ Mc/s}, \text{ See Note 4}$	0	0.2	0.32	pF
τ_b, τ_c Collector-Base Time Constant	$V_{CB} = 10 \text{ V}, I_E = -4 \text{ mA}, f = 79.8 \text{ Mc/s}$		6	12	ps

NOTES: 3. These parameters must be measured using pulse techniques. $t_p = 300 \mu s$, duty cycle $\leq 2\%$.

4. Collector-Base Capacitance is measured using three-terminal measurement techniques with the case and emitter guarded.

operating characteristics at 25°C free-air temperature

PARAMETER	TEST CONDITIONS†	TIS56			TIS57			UNIT
		MIN	TYP	MAX	MIN	TYP	MAX	
NF Spot Noise Figure	$V_{CE} = 10 \text{ V}, I_C = 3 \text{ mA}, R_G = 50 \Omega, f = 200 \text{ Mc/s}$	2.8	3.3					dB
	$V_{CE} = 10 \text{ V}, I_C = 3 \text{ mA}, R_G = 50 \Omega, f = 45 \text{ Mc/s}$				3	6		dB
G_{po} Unneutralized Small-Signal Common-Emitter Insertion Power Gain	$V_{CC} = 12 \text{ V}, I_C \approx 2.5 \text{ mA}, V_{BB} = 2.1 \text{ V}, R'_G = 150 \Omega, R'_L = 1 \text{ k}\Omega, f = 200 \text{ Mc/s}, \text{ See Figure 2}$	12	16	18				dB
	$V_{CC} = 12 \text{ V}, I_C \approx 4.5 \text{ mA}, V_{BB} = 3.1 \text{ V}, R'_G = 500 \Omega, R'_L = 250 \Omega, f = 45 \text{ Mc/s}, \text{ See Figure 2}$				25	30	33	dB
$V_{BB(GC)}$ Gain-Control Base-Supply Voltage	$V_{CC} = 12 \text{ V}, I_C \approx 2.5 \text{ mA}, \Delta G_{po} = -30 \text{ dB}, R'_G = 150 \Omega, R'_L = 1 \text{ k}\Omega, f = 200 \text{ Mc/s}, \text{ See Figure 2}$	3.7	4.6					V
	$V_{CC} = 12 \text{ V}, I_C \approx 4.5 \text{ mA}, \Delta G_{po} = -30 \text{ dB}, R'_G = 500 \Omega, R'_L = 250 \Omega, f = 45 \text{ Mc/s}, \text{ See Figure 2}$				3.7	4.6		V

†The fourth lead (case) is grounded for all measurements except C_{cb} .

TYPES TIS56 AND TIS57 N-P-N PLANAR SILICON TRANSISTORS

THERMAL INFORMATION

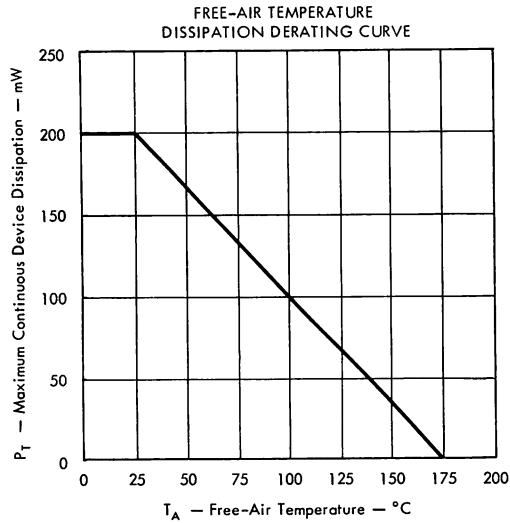
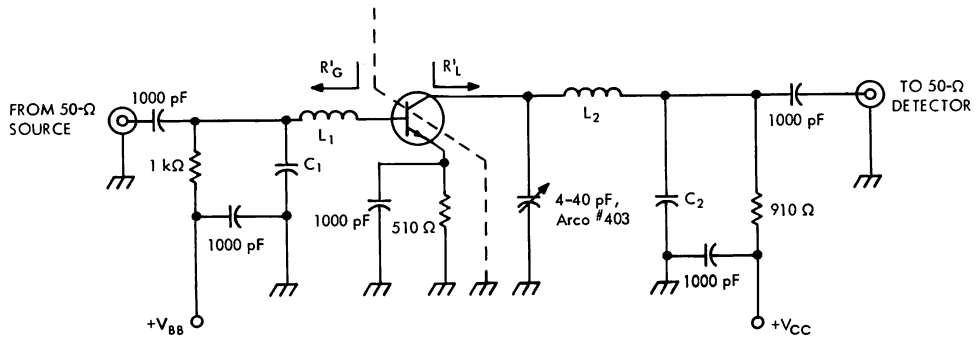

FIGURE 1

PARAMETER MEASUREMENT INFORMATION



COMPONENTS FOR $f = 45$ Mc/s

- C_1 : 36 pF
- C_2 : 47 pF
- L_1 : 8T #20 enameled copper wire, close-wound on $\frac{1}{4}$ " diameter form
- L_2 : 10T #20 enameled copper wire, close-wound on $\frac{1}{4}$ " diameter form

COMPONENTS FOR $f = 200$ Mc/s

- C_1 : 18 pF
- C_2 : 270 pF
- L_1 : 2T #20 enameled copper wire, $\frac{1}{8}$ " pitch, wound on $\frac{7}{32}$ " diameter form
- L_2 : 2T #14 enameled copper wire, $\frac{1}{8}$ " pitch, wound on $\frac{7}{32}$ " diameter form

FIGURE 2 — POWER-GAIN AND GAIN-CONTROL-VOLTAGE TEST CIRCUIT

TYPES TIS56 AND TIS57

N-P-N PLANAR SILICON TRANSISTORS

TYPICAL CHARACTERISTICS

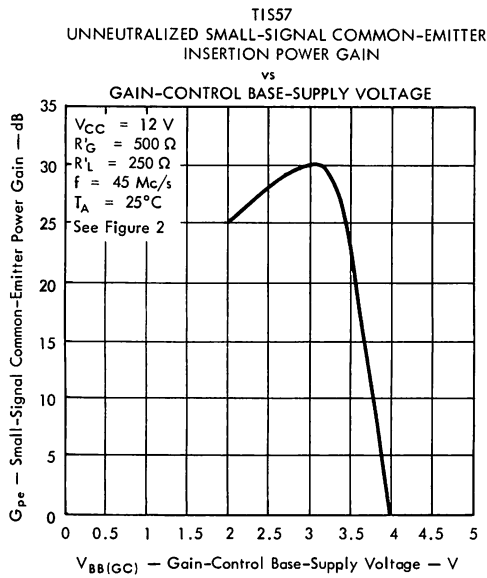
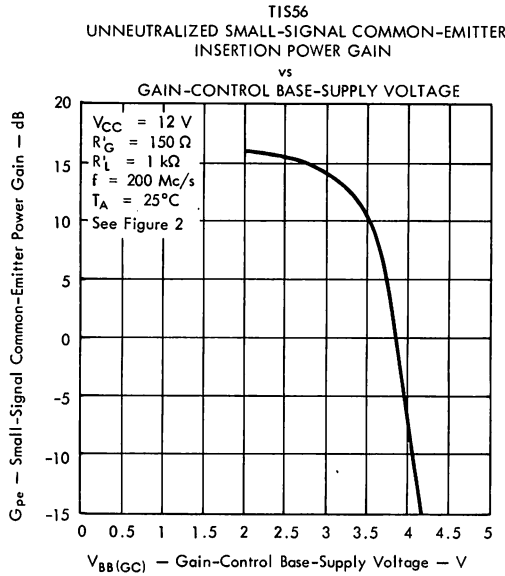

TYPES TIS62, TIS63, TIS64 N-P-N PLANAR SILICON TRANSISTORS



TYPES TIS62, TIS63, TIS64
BULLETIN NO. DL-5 689443, DECEMBER 1966
REVISED MAY 1968

SILECT† TRANSISTORS

Electrical Equivalents of TI407, TI408, and TI409

Encapsulated in Plastic for Application in
AM-FM Receivers and General-Purpose High-Frequency Amplifiers

TIS62 Features:

- $f_T \dots 500$ MHz min
- Low $r_b'C_c \dots 20$ ps max
- NF... 6 dB max at 100 MHz

Rugged, One-Piece Construction with Standard TO-18 100-mil Pin Circle

mechanical data

These transistors are encapsulated in a plastic compound specifically designed for this purpose, using a highly mechanized process‡ developed by Texas Instruments. The case will withstand soldering temperatures without deformation. These devices exhibit stable characteristics under high-humidity conditions and are capable of meeting MIL-STD-202C method 106B. The transistors are insensitive to light.

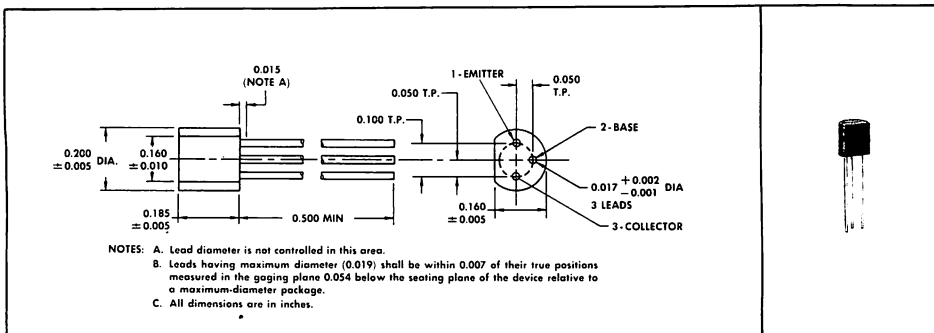

absolute maximum ratings at 25°C free-air temperature (unless otherwise noted)

Collector-Base Voltage	30 V
Collector-Emitter Voltage (See Note 1)	12 V
Emitter-Base Voltage	3 V
Continuous Collector Current	30 mA
Continuous Device Dissipation at (or below) 25°C Free-Air Temperature (See Note 2)	250 mW
Storage Temperature Range	-65°C to 150°C
Lead Temperature 1/8 Inch from Case for 10 Seconds	260°C

- NOTES: 1. This value applies when the base-emitter diode is open-circuited.
2. Derate linearly to 150°C free-air temperature at the rate of 2 mW/deg.

†Trademark of Texas Instruments
‡Patent Pending



TEXAS INSTRUMENTS
INCORPORATED
POST OFFICE BOX 5012 • DALLAS, TEXAS 75222

TYPES TIS62, TIS63, TIS64

N-P-N PLANAR SILICON TRANSISTORS

electrical characteristics at 25°C free-air temperature

PARAMETER	TEST CONDITIONS	TIS62		TIS63		TIS64		UNIT
		MIN	MAX	MIN	MAX	MIN	MAX	
$V_{(BR)CBO}$ Collector-Base Breakdown Voltage	$I_C = 100 \mu A, I_E = 0$	30		30		30		V
$V_{(BR)CEO}$ Collector-Emitter Breakdown Voltage	$I_C = 4 mA, I_B = 0$	12		12		12		V
$V_{(BR)EBO}$ Emitter-Base Breakdown Voltage	$I_E = 100 \mu A, I_C = 0$	3		3		3		V
I_{CBO} Collector Cutoff Current	$V_{CB} = 10 V, I_E = 0$		100		100		100	nA
h_{FE} Static Forward Current Transfer Ratio	$V_{CE} = 10 V, I_C = 4 mA$	30		20		20		
$ h_{fe} $ Small-Signal Common-Emitter Forward Current Transfer Ratio	$V_{CE} = 10 V, I_C = 4 mA, f = 455 kHz$			27				dB
	$V_{CE} = 10 V, I_C = 4 mA, f = 10 MHz$			27				
	$V_{CE} = 10 V, I_C = 4 mA, f = 100 MHz$	5	18	4	18	3	18	
C_{cb} Collector-Base Capacitance	$V_{CB} = 10 V, I_E = 0, f = 1 MHz, \text{ See Note 3}$	0.7	1.6	0.7	1.6	0.7	2.2	pF
$\tau_b' C_c$ Collector-Base Time Constant	$V_{CB} = 10 V, I_E = -4 mA, f = 79.8 MHz$		20		26		32	ps

NOTE 3: This parameter is measured using three-terminal measurement techniques with the emitter guarded.

operating characteristics at 25°C free-air temperature

PARAMETER	TEST CONDITIONS	TIS62		UNIT
		TYP	MAX	
NF Spot Noise Figure	$V_{CE} = 10 V, I_C = 2 mA, R_G = 300 \Omega, f = 100 MHz$	4	6	dB

TYPICAL CHARACTERISTICS AT $T_A = 25^\circ C$

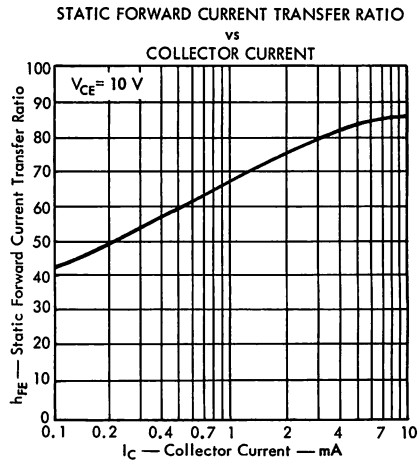
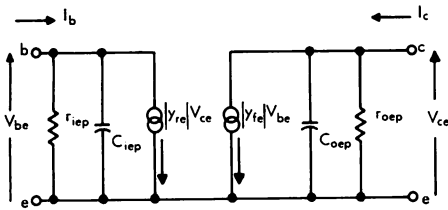

FIGURE 1

TYPES TIS62, TIS63, TIS64 N-P-N PLANAR SILICON TRANSISTORS

COMMON-EMITTER EQUIVALENT CIRCUIT USING SHORT-CIRCUIT "y" PARAMETERS



$$I_b = |y_{re}| V_{ce} + |y_{ie}| V_{be}$$

$$I_c = |y_{re}| V_{be} + |y_{oe}| V_{ce}$$

$$|y_{ie}| = \frac{I_b}{V_{be}} \Big|_{V_{ce} = 0} = \frac{1}{r_{iep}} + j\omega C_{iep}$$

$$|y_{oe}| = \frac{I_c}{V_{ce}} \Big|_{V_{be} = 0} = \frac{1}{r_{oep}} + j\omega C_{oep}$$

TYPICAL CHARACTERISTICS AT 455 kHz, $T_A = 25^\circ\text{C}$

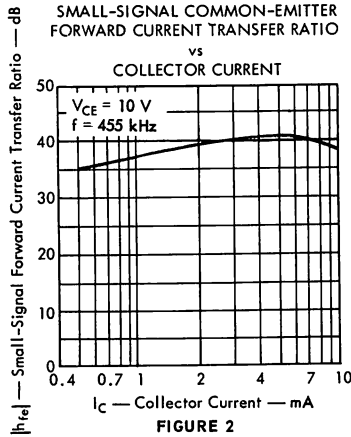

FIGURE 2

PARALLEL-EQUIVALENT SMALL-SIGNAL COMMON-EMITTER SHORT-CIRCUIT INPUT RESISTANCE vs COLLECTOR CURRENT

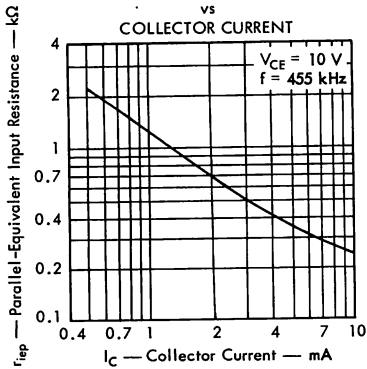

FIGURE 3

PARALLEL-EQUIVALENT SMALL-SIGNAL COMMON-EMITTER SHORT-CIRCUIT OUTPUT RESISTANCE vs COLLECTOR CURRENT

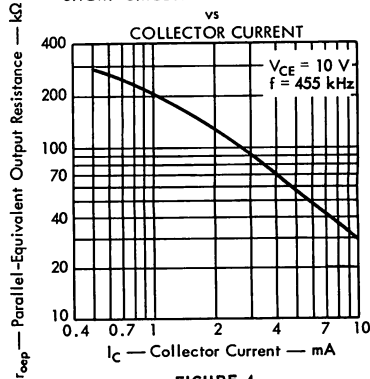

FIGURE 4

TYPES TIS62, TIS63, TIS64

N-P-N PLANAR SILICON TRANSISTORS

TYPICAL CHARACTERISTICS AT 10 MHz, $T_A = 25^\circ\text{C}$

PARALLEL-EQUIVALENT SMALL-SIGNAL COMMON-EMITTER
SHORT-CIRCUIT INPUT CAPACITANCE

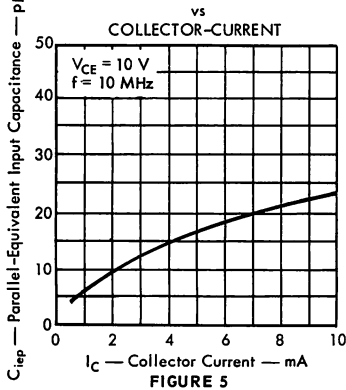

PARALLEL-EQUIVALENT SMALL-SIGNAL COMMON-EMITTER
SHORT-CIRCUIT OUTPUT CAPACITANCE

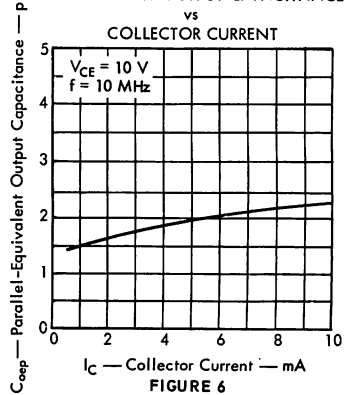

SMALL-SIGNAL COMMON-EMITTER
FORWARD CURRENT TRANSFER RATIO

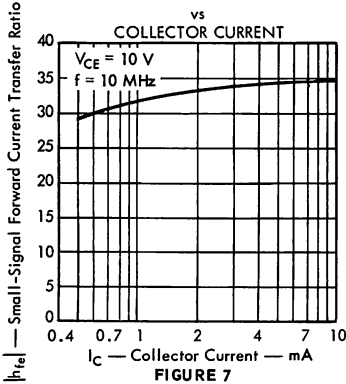

SMALL-SIGNAL COMMON-EMITTER
FORWARD TRANSFER ADMITTANCE

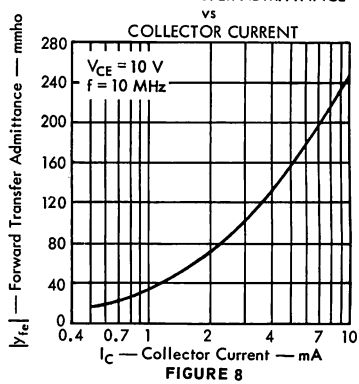

PARALLEL-EQUIVALENT SMALL-SIGNAL COMMON-EMITTER
SHORT-CIRCUIT INPUT RESISTANCE

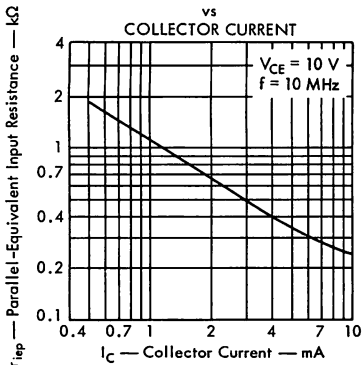

PARALLEL-EQUIVALENT SMALL-SIGNAL COMMON-EMITTER
SHORT-CIRCUIT OUTPUT RESISTANCE

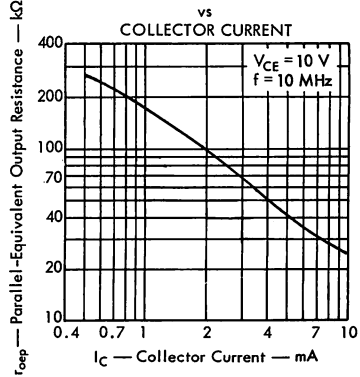

TYPES TIS62, TIS63, TIS64 N-P-N PLANAR SILICON TRANSISTORS

TYPICAL CHARACTERISTICS AT 100 MHz, $T_A = 25^\circ\text{C}$

PARALLEL-EQUIVALENT SMALL-SIGNAL COMMON-EMITTER
SHORT-CIRCUIT INPUT CAPACITANCE

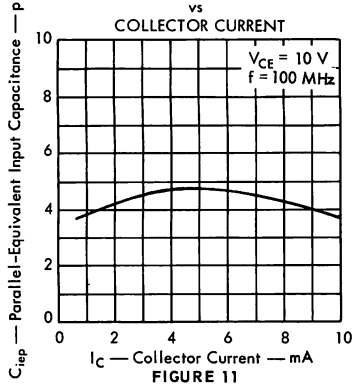

PARALLEL-EQUIVALENT SMALL-SIGNAL COMMON-EMITTER
SHORT-CIRCUIT OUTPUT CAPACITANCE

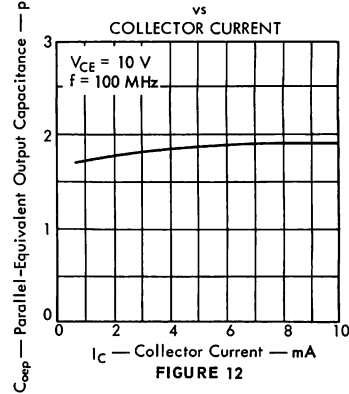

SMALL-SIGNAL COMMON-EMITTER
FORWARD CURRENT TRANSFER RATIO

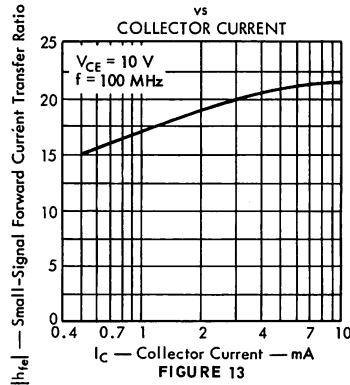

PARALLEL-EQUIVALENT SMALL-SIGNAL COMMON-EMITTER
SHORT-CIRCUIT INPUT RESISTANCE

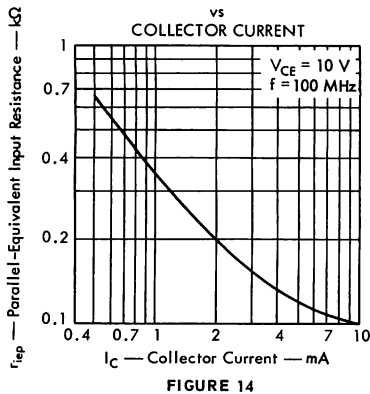

PARALLEL-EQUIVALENT SMALL-SIGNAL COMMON-EMITTER
SHORT-CIRCUIT OUTPUT RESISTANCE

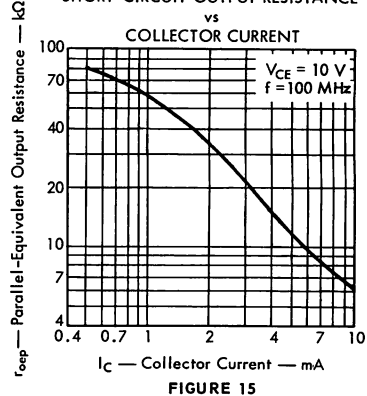

TYPES TIS62, TIS63, TIS64 N-P-N PLANAR SILICON TRANSISTORS

TYPICAL APPLICATION DATA

TYPICAL FM TUNER WITH IF AMPLIFIER STAGE

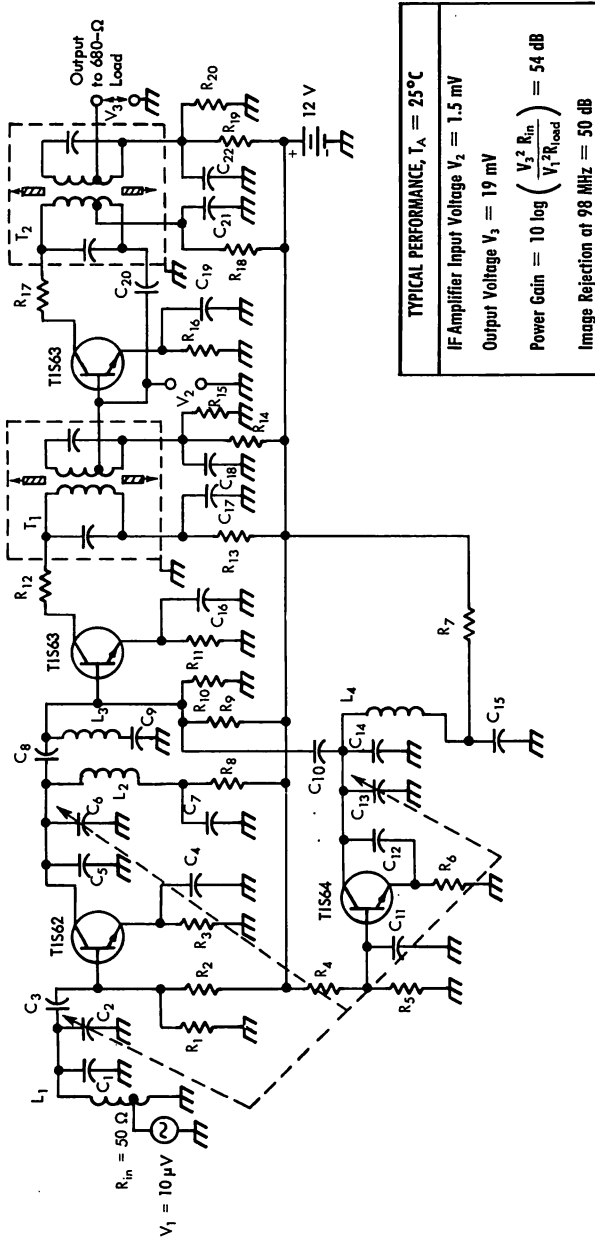

CIRCUIT COMPONENT INFORMATION

TRANSFORMERS

- T₁: Radio Industries #18300 (or equivalent)
- T₂: Radio Industries #18301 (or equivalent)

COILS

- L₁: 4 T #18 bus, 5/16" ID, 3/4" length, Turns Ratio $\approx 1/2$ to 4.
- L₂: 4 T #18 bus, 5/16" ID, 3/4" length,
- L₃: 1 μH
- L₄: 3 T #18 bus, 5/16" ID, 3/4" length

RESISTORS

- R₁: 8.2 k Ω
 - R₂: 33 k Ω
 - R₃: 1 k Ω
 - R₄: 27 k Ω
 - R₅: 2.7 k Ω
 - R₆: 1 k Ω
 - R₇: 330 Ω
 - R₈: 330 Ω
 - R₉: 15 k Ω
 - R₁₀: 2.7 k Ω
 - R₁₁: 1 k Ω
 - R₁₂: 120 Ω
 - R₁₃: 330 Ω
 - R₁₄: 10 k Ω
 - R₁₅: 3.9 k Ω
 - R₁₆: 1.2 k Ω
 - R₁₇: 120 Ω
 - R₁₈: 330 Ω
 - R₁₉: 10 k Ω
 - R₂₀: 3.9 k Ω
- All resistors 1/2 W, ten percent tolerance.

CAPACITORS

- C₁: 10 pF
- C₂: 30-45 pF
- C₃: 3.3 pF
- C₄: 0.001 μF
- C₅: 10 pF
- C₆: 30-45 pF
- C₇: 0.001 μF
- C₈: 3.3 pF
- C₉: 240 pF
- C₁₀: 0.82 pF
- C₁₁: 0.001 μF
- C₁₂: 3.3 pF
- C₁₃: 30-45 pF
- C₁₄: 10 pF
- C₁₅: 0.001 μF
- C₁₆: 0.01 μF
- C₁₇: 0.01 μF
- C₁₈: 0.01 μF
- C₁₉: 0.01 μF
- C₂₀: 2.2 pF
- C₂₁: 0.01 μF
- C₂₂: 0.01 μF

TYPES TIS84, TIS85 N-P-N PLANAR SILICON TRANSISTORS



TYPES TIS84, TIS85
BULLETIN NO. DI-S-6710195, JUNE 1967

SILECT† HIGH-FREQUENCY TRANSISTORS DESIGNED FOR TV TUNER AND IF APPLICATIONS

Featuring Low-Feedback Capacitance and Forward-AGC Characteristics

- TIS84 for Tuner RF Amplifiers
- TIS85 for IF Amplifiers

Rugged, One-Piece Construction with Standard TO-18 100-mil Pin Circle

mechanical data

These transistors are encapsulated in a plastic compound specifically designed for this purpose, using a highly mechanized process‡ developed by Texas Instruments. The case will withstand soldering temperatures without deformation. These devices exhibit stable characteristics under high-humidity conditions and are capable of meeting MIL-STD-202C method 106B. The transistors are insensitive to light.

Feedback capacitance is minimized by placing the emitter terminal between the base and collector terminals, thus optimizing compatibility with advanced high-frequency design.

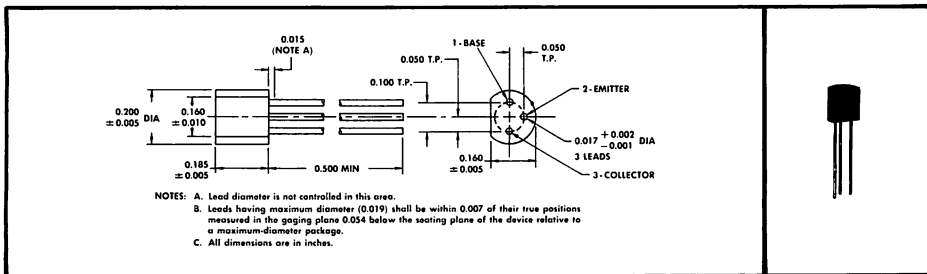

absolute maximum ratings at 25°C free-air temperature (unless otherwise noted)

Collector-Base Voltage	40 V
Collector-Emitter Voltage (See Note 1)	30 V
Emitter-Base Voltage	4 V
Continuous Collector Current	50 mA
Continuous Device Dissipation at (or below) 25°C Free-Air Temperature (See Note 2)	250 mW
Storage Temperature Range	-65°C to 150°C
Lead Temperature 1/8 Inch from Case for 10 Seconds	260°C

electrical characteristics at 25°C free-air temperature (unless otherwise noted)

PARAMETER	TEST CONDITIONS	TIS84			TIS85			UNIT
		MIN	TYP	MAX	MIN	TYP	MAX	
$V_{(BR)CBO}$ Collector-Base Breakdown Voltage	$I_C = 10 \mu A, I_E = 0$	40			40			V
$V_{(BR)CEO}$ Collector-Emitter Breakdown Voltage	$I_C = 10 \text{ mA}, I_B = 0$, See Note 3	30			30			V
I_{CBO} Collector Cutoff Current	$V_{CB} = 10 \text{ V}, I_E = 0$			50			50	nA
	$V_{CB} = 10 \text{ V}, I_E = 0, T_A = 85^\circ C$			5			5	μA
I_{EBO} Emitter Cutoff Current	$V_{EB} = 4 \text{ V}, I_C = 0$			10			10	μA
h_{FE} Static Forward Current Transfer Ratio	$V_{CE} = 10 \text{ V}, I_C = 4 \text{ mA}$	30			25			
V_{BE} Base-Emitter Voltage	$V_{CE} = 10 \text{ V}, I_C = 4 \text{ mA}$		0.84			0.84		V

- NOTES: 1. This value applies when the base-emitter diode is open-circuited.
2. Derate linearly to 150°C free-air temperature at the rate of 2 mW/deg.
3. This parameter must be measured using pulse techniques. $I_p = 300 \mu s$, duty cycle $\leq 2\%$.

†Trademark of Texas Instruments
‡Patent pending

TYPES TIS84, TIS85

N-P-N PLANAR SILICON TRANSISTORS

electrical characteristics at 25°C free-air temperature

PARAMETER	TEST CONDITIONS	TIS84			TIS85			UNIT
		MIN	TYP	MAX	MIN	TYP	MAX	
$ h_{fe} $	Small-Signal Common-Emitter Forward Current Transfer Ratio $V_{CE} = 10\text{ V}, I_C = 4\text{ mA}, f = 100\text{ MHz}$	3.5	6.5		3.5	6.5		
$ y_{fo} $	Small-Signal Common-Emitter Forward Transfer Admittance $V_{CE} = 10\text{ V}, I_C = 4\text{ mA}, f = 200\text{ MHz}$	60	80				mmho	
	$V_{CE} = 10\text{ V}, I_C = 4\text{ mA}, f = 45\text{ MHz}$				80	105		
ϕ_{yfo}	Phase Angle of Small-Signal Common-Emitter Forward Transfer Admittance $V_{CE} = 10\text{ V}, I_C = 4\text{ mA}, f = 200\text{ MHz}$	-50°	-60°	-80°				
	$V_{CE} = 10\text{ V}, I_C = 4\text{ mA}, f = 45\text{ MHz}$				-10°	-18°		-25°
C_{ios}	Parallel-Equivalent Common-Emitter Short-Circuit Input Capacitance† $V_{CE} = 10\text{ V}, I_C = 4\text{ mA}, f = 200\text{ MHz}$		11				pF	
	$V_{CE} = 10\text{ V}, I_C = 4\text{ mA}, f = 45\text{ MHz}$				18			
C_{res}	Common-Emitter Short-Circuit Reverse Transfer Capacitance† $V_{CE} = 10\text{ V}, I_C = 1\text{ mA}, f = 0.1\text{ MHz to }1\text{ MHz}$	0.32	0.4		0.32	0.4	pF	
C_{oes}	Parallel-Equivalent Common-Emitter Short-Circuit Output Capacitance† $V_{CE} = 10\text{ V}, I_C = 4\text{ mA}, f = 200\text{ MHz}$		1.1				pF	
	$V_{CE} = 10\text{ V}, I_C = 4\text{ mA}, f = 45\text{ MHz}$				1.1			
$Re(h_{ie})$	Real Part of Small-Signal Common-Emitter Input Impedance $V_{CE} = 10\text{ V}, I_C = 4\text{ mA}, f = 200\text{ MHz}$	25	60				Ω	
	$V_{CE} = 10\text{ V}, I_C = 4\text{ mA}, f = 45\text{ MHz}$				50	80		
$Re(y_{ie})$	Real Part of Small-Signal Common-Emitter Input Admittance $V_{CE} = 10\text{ V}, I_C = 4\text{ mA}, f = 200\text{ MHz}$	14	40				mmho	
	$V_{CE} = 10\text{ V}, I_C = 4\text{ mA}, f = 45\text{ MHz}$				3	6		
$Re(y_{oe})$	Real Part of Small-Signal Common-Emitter Output Admittance $V_{CE} = 10\text{ V}, I_C = 4\text{ mA}, f = 200\text{ MHz}$	0.2	0.5				mmho	
	$V_{CE} = 10\text{ V}, I_C = 4\text{ mA}, f = 45\text{ MHz}$				0.05	0.2		

† C_{ies} , C_{res} , and C_{oes} are defined as the imaginary parts of the small-signal, common-emitter, short-circuit admittances divided by $2\pi f$.

operating characteristics at 25°C free-air temperature

PARAMETER	TEST CONDITIONS	TIS84			TIS85			UNIT
		MIN	TYP	MAX	MIN	TYP	MAX	
NF	Spot Noise Figure $V_{CE} = 10\text{ V}, I_C = 3\text{ mA}, R_G = 50\ \Omega, f = 200\text{ MHz}$	2.8	3.3				dB	
	$V_{CE} = 10\text{ V}, I_C = 3\text{ mA}, R_G = 50\ \Omega, f = 45\text{ MHz}$				3	6		
G_{po}	Unneutralized Small-Signal Common-Emitter Insertion Power Gain $V_{CC} = 12\text{ V}, I_C \approx 2.5\text{ mA}, V_{BB} = 2.1\text{ V}, R_{E'} = 150\ \Omega, R_L' = 1\text{ k}\Omega, f = 200\text{ MHz},$ See Figure 1	12	16	18			dB	
	$V_{CC} = 12\text{ V}, I_C \approx 4.5\text{ mA}, V_{BB} = 3.1\text{ V}, R_{E'} = 500\ \Omega, R_L' = 250\ \Omega, f = 45\text{ MHz},$ See Figure 1				25	30		33
$V_{BB(BC)}$	Gain-Control Base-Supply Voltage $V_{CC} = 12\text{ V}, R_{E'} = 150\ \Omega, R_L' = 1\text{ k}\Omega, \Delta G_{po} = -30\text{ dB}\ddagger, f = 200\text{ MHz},$ See Figure 1	3.7	4.6				V	
	$V_{CC} = 12\text{ V}, R_{E'} = 500\ \Omega, R_L' = 250\ \Omega, \Delta G_{po} = -30\text{ dB}\ddagger, f = 45\text{ MHz},$ See Figure 1				3.7	4.6		

‡ ΔG_{po} is defined as the change in G_{po} from the value at $V_{BB} = 2.1\text{ V}$ at 200 MHz or from the value at $V_{BB} = 3.1\text{ V}$ at 45 MHz.

TYPES TIS84, TIS85 N-P-N PLANAR SILICON TRANSISTORS

PARAMETER MEASUREMENT INFORMATION

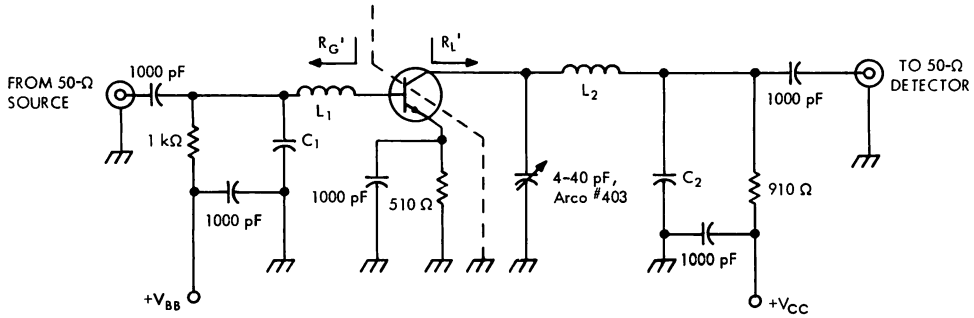

COMPONENTS FOR $f = 45$ MHz

- C_1 : 36 pF
- C_2 : 47 pF
- L_1 : 8 T #20 enameled copper wire, close-wound on $\frac{1}{4}$ " diameter form
- L_2 : 10 T #20 enameled copper wire, close-wound on $\frac{1}{4}$ " diameter form

COMPONENTS FOR $f = 200$ MHz

- C_1 : 18 pF
- C_2 : 270 pF
- L_1 : 2 T #20 enameled copper wire, $\frac{1}{8}$ " pitch, wound on $\frac{7}{32}$ " diameter form
- L_2 : 2 T #14 enameled copper wire, $\frac{1}{8}$ " pitch, wound on $\frac{7}{32}$ " diameter form

FIGURE 1 — POWER-GAIN AND GAIN-CONTROL-VOLTAGE TEST CIRCUIT

TYPICAL CHARACTERISTICS

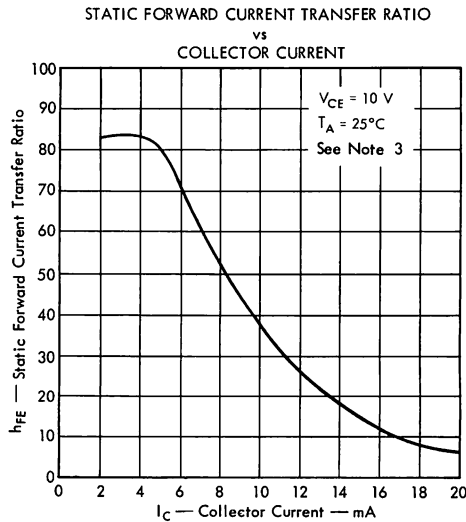

FIGURE 2

NOTE 3: This parameter must be measured using pulse techniques. $t_p = 300 \mu s$, duty cycle = 10%.

TYPES TIS84, TIS85 N-P-N PLANAR SILICON TRANSISTORS

TYPICAL CHARACTERISTICS

TIS84
SMALL-SIGNAL COMMON-EMITTER INPUT ADMITTANCE
vs
COLLECTOR CURRENT

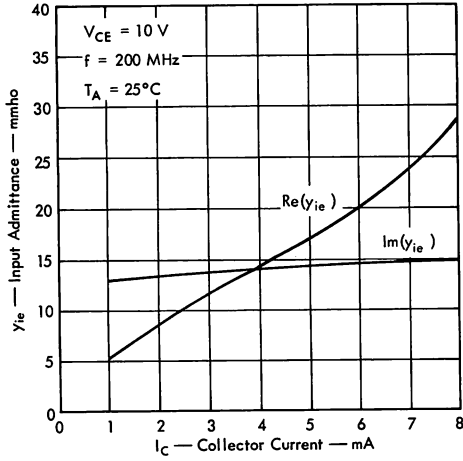

FIGURE 3

TIS84
SMALL-SIGNAL COMMON-EMITTER
FORWARD TRANSFER ADMITTANCE
vs
COLLECTOR CURRENT

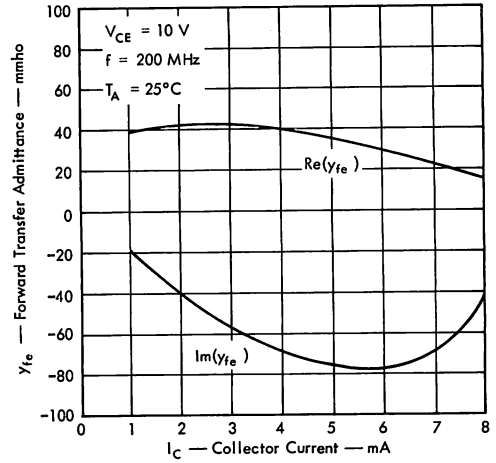

FIGURE 4

TIS84
SMALL-SIGNAL COMMON-EMITTER OUTPUT ADMITTANCE
vs
COLLECTOR CURRENT

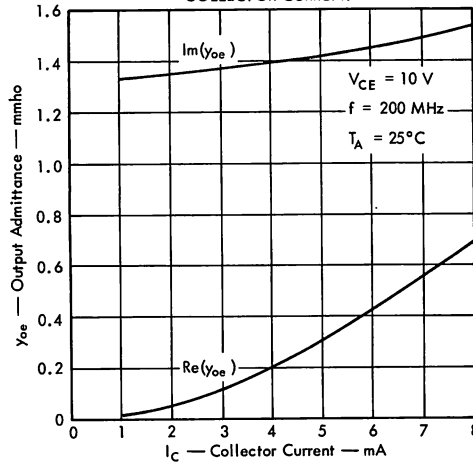

FIGURE 5

TYPES T1S84, T1S85 N-P-N PLANAR SILICON TRANSISTORS

TYPICAL CHARACTERISTICS

T1S85
SMALL-SIGNAL COMMON-EMITTER INPUT ADMITTANCE
vs
COLLECTOR CURRENT

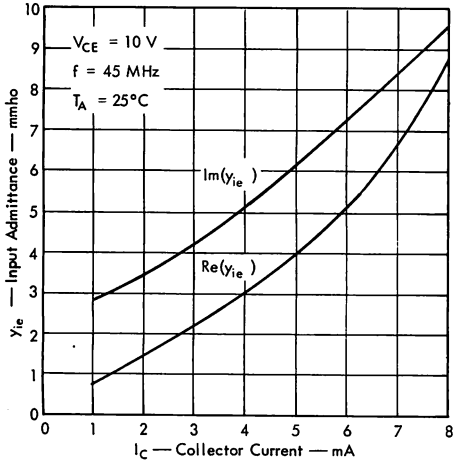

FIGURE 6

T1S85
SMALL-SIGNAL COMMON-EMITTER
FORWARD TRANSFER ADMITTANCE
vs
COLLECTOR CURRENT

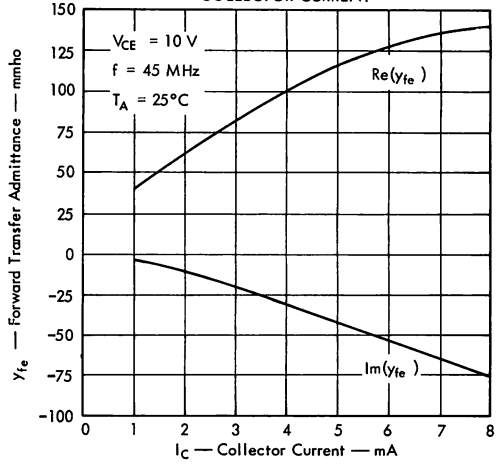

FIGURE 7

T1S85
SMALL-SIGNAL COMMON-EMITTER OUTPUT ADMITTANCE
vs
COLLECTOR CURRENT

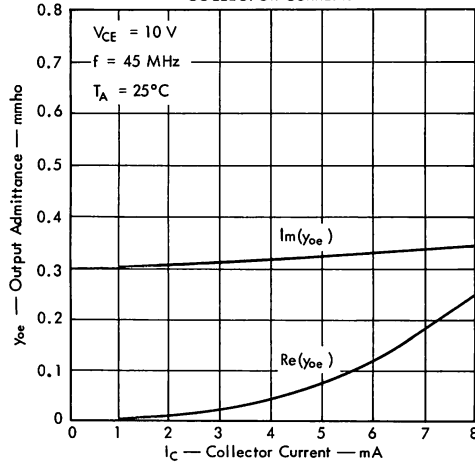
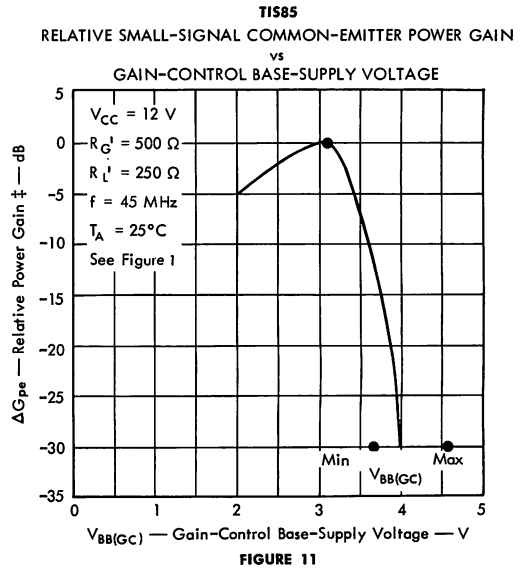
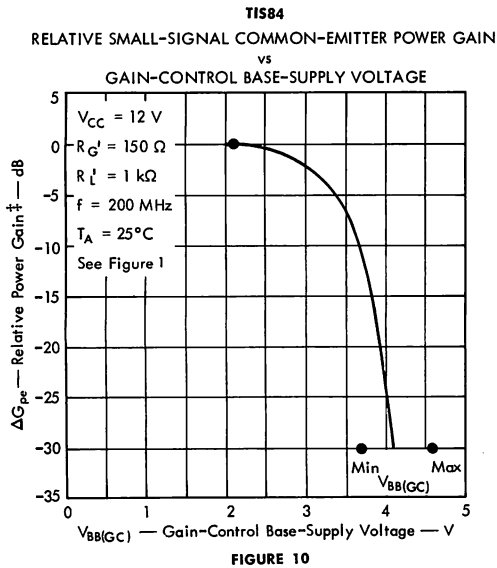
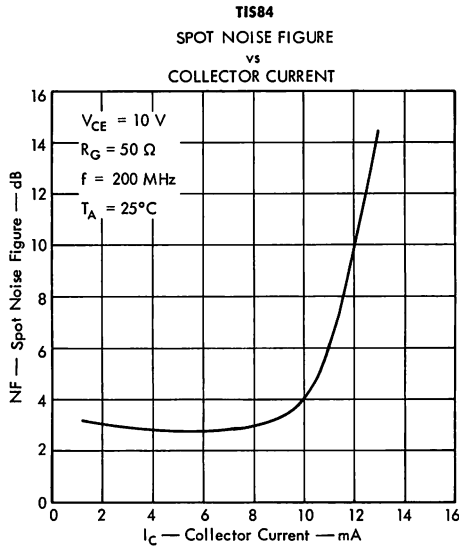

FIGURE 8

TYPES TIS84, TIS85 N-P-N PLANAR SILICON TRANSISTORS

TYPICAL CHARACTERISTICS



† ΔG_{pe} is defined as the change in G_{pe} from the value at $V_{BB} = 2.1$ V at 200 MHz or from the value at $V_{BB} = 3.1$ V at 45 MHz.

TYPES TIS84, TIS85 N-P-N PLANAR SILICON TRANSISTORS

TYPICAL APPLICATION DATA

TYPICAL TV VHF TUNER PERFORMANCE			
CHANNEL	POWER GAIN	NOISE FIGURE	IF REJECT
2	39	5.5	55
3	38	5.2	55
4	38	5.7	57
5	36	5.5	59
6	38	6.0	63
7	37	5.5	72
8	35	6.1	71
9	36	5.5	72
10	34	5.5	84
11	35	6.2	79
12	35	6.2	76
13	35	6.1	65

POWER SUPPLY INFORMATION		
Power Supply	MAXIMUM GAIN	MINIMUM GAIN
12 V at 19.5 mA	12 V at 19.5 mA	12 V at 34 mA
V _{acc} Supply	1.8 V at 0.1 mA	8 V at 2.85 mA

TYPICAL TUNER AND IF AMPLIFIER (SEE FIG. 13) COMBINED PERFORMANCE	
CHANNEL	V _{in(cri)} (μV)
2	3.5
3	3.5
4	3.5
5	4.5
6	3.5
7	11.0
8	10.0
9	9.0
10	13.0
11	12.0
12	9.5
13	11.0

Frequency Rejection:
 39.75 MHz: down 13.5 dB
 41.25 MHz: down 13.5 dB
 41.80 MHz: down 6 dB
 45.75 MHz: down 6 dB
 47.25 MHz: down 46.5 dB

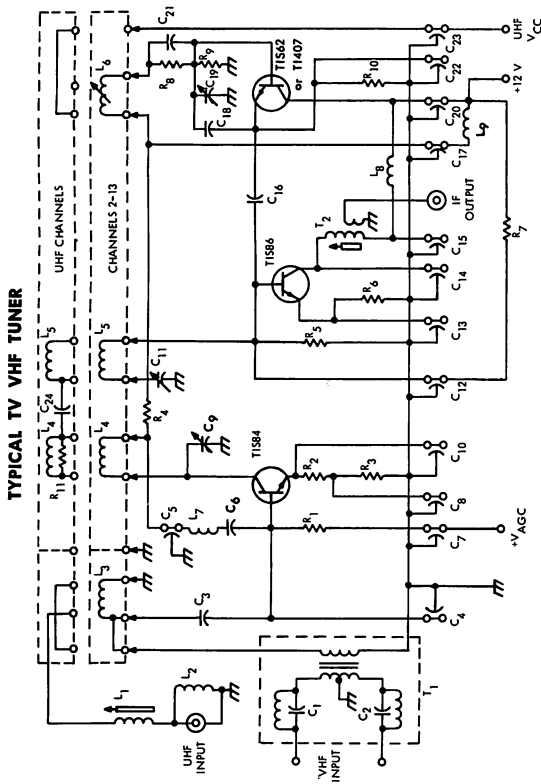

CIRCUIT COMPONENT INFORMATION

CAPACITORS

- C₁: 47 pF
- C₂: 47 pF
- C₃: 8.2 pF
- C₄: 18 pF feed-thru
- C₅: 30 pF feed-thru
- C₆: 0.68 pF
- C₇: 1000 pF feed-thru
- C₈: 1000 pF feed-thru
- C₉: 2.8 pF air trimmer
- C₁₀: 39 pF feed-thru
- C₁₁: 2.8 pF air trimmer
- C₁₂: 30 pF feed-thru
- C₁₃: 1000 pF feed-thru
- C₁₄: 10 pF feed-thru
- C₁₅: 1000 pF feed-thru
- C₁₆: 3.6 pF
- C₁₇: 1000 pF feed-thru
- C₁₈: 5.6 pF
- C₁₉: 0.5-3 pF air trimmer
- C₂₀: 1000 pF feed-thru
- C₂₁: 5.6 pF
- C₂₂: 2.5 pF feed-thru
- C₂₃: 1000 pF feed-thru
- C₂₄: 5.6 pF

RESISTORS (1/2 W, ten percent)

- R₁: 1 kΩ
- R₂: 10 kΩ
- R₃: 15 Ω
- R₄: 560 Ω
- R₅: 390 Ω
- R₆: 1.2 kΩ
- R₇: 10 kΩ
- R₈: 5.6 kΩ
- R₉: 10 kΩ
- R₁₀: 1 kΩ
- R₁₁: 10 kΩ

INDUCTORS

- L₁: UHF matching coil
- L₂: UHF matching coil
- L₃: as required per channel
- L₄: as required per channel
- L₅: as required per channel
- L₆: as required per channel
- L₇: neutralizing coil
- L₈: RFC
- L₉: RFC

TRANSFORMERS

- T₁: balun assembly, including IF traps
- T₂: IF output transformer

FIGURE 12 — TYPICAL TV VHF TUNER

TYPES TIS84, TIS85 N-P-N PLANAR SILICON TRANSISTORS

TYPICAL APPLICATION DATA

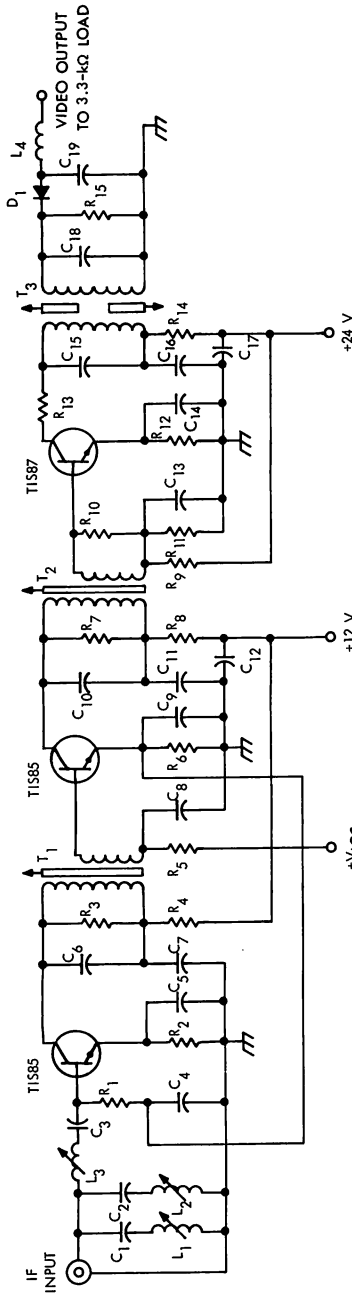

CIRCUIT COMPONENT INFORMATION

RESISTORS (1/2 W, TEN PERCENT)

R ₁ : 20 Ω	R ₁₁ : 4.7 kΩ
R ₂ : 470 Ω	R ₁₂ : 1 kΩ
R ₃ : 1 kΩ	R ₁₃ : 56 Ω
R ₄ : 270 Ω	R ₁₄ : 220 Ω
R ₅ : 1 kΩ	R ₁₅ : 20 Ω

CAPACITORS

C ₁ : 8.2 pF	C ₁₁ : 0.002 μF
C ₂ : 10 pF	C ₁₂ : 0.002 μF
C ₃ : 18 pF	C ₁₃ : 0.002 μF
C ₄ : 0.002 μF	C ₁₄ : 0.002 μF
C ₅ : 0.002 μF	C ₁₅ : 15 pF

DIODE

D₁: 1N60

C ₆ : 15 pF	C ₁₆ : 0.002 μF
C ₇ : 0.002 μF	C ₁₇ : 0.002 μF
C ₈ : 0.002 μF	C ₁₈ : 18 pF
C ₉ : 0.002 μF	C ₁₉ : 10 pF

INDUCTORS

- L₁: self sound, 14 T, #27 enameled, close-wound, 9/32" OD form, Arnold Eng. core type "J"
- L₂: adjacent sound, 10 T, #27 enameled, close-wound, 9/32" OD form, Arnold Eng. core type "J"
- L₃: series inductor, 6 T, #27 enameled, close-wound, 9/32" OD form, Arnold Eng. core type "J"
- L₄: filter inductor, 10 μH, Delevan RFC

TRANSFORMERS

- T₁: pri.: 6T, sec.: 2 T, #27 enameled, close-wound, bifilar, 9/32" OD form, Arnold Eng. core type "J"
- T₂: pri.: 8T, sec.: 2 T, #27 enameled, close-wound, bifilar, 9/32" OD form, Arnold Eng. core type "J"
- T₃: pri.: 9T, sec.: 8 T, #25 enameled, close-wound, pri. and sec. spacing: 0.18", 9/32" OD form, Arnold Eng. core type "J"

POWER SUPPLY INFORMATION	
	MINIMUM GAIN
Power Supply	12 V at 9 mA 24 V at 10 mA
V _{acc} Supply	4 V at 0 mA 7.5 V at 0.5 mA

TYPICAL TV IF AMPLIFIER PERFORMANCE	
Sensitivity: V _{int(f)}	= 100 μV for V _{out(pcc)} = 1 V
Frequency Rejection:	
	39.75 MHz: down 17 dB
	41.25 MHz: down 20 dB
	45.75 MHz: down 3 dB
	47.25 MHz: down 18 dB

FIGURE 13 — TYPICAL TV IF AMPLIFIER

TYPES TIS86, TIS87 N-P-N EPITAXIAL PLANAR SILICON TRANSISTORS



TYPES TIS86, TIS87
BULLETIN NO. DL-5 6810225, JUNE 1967
REVISED MAY 1968

SILECT† HIGH-FREQUENCY TRANSISTORS DESIGNED FOR TV MIXER AND NON-AGC IF STAGES

Featuring Low Feedback Capacitance and
Full Characterization to Simplify Circuit Design

- TIS86 for Mixer
- TIS87 for Non-AGC IF Amplifier

Rugged, One-Piece Construction with Standard TO-18 100-mil Pin Circle

mechanical data

These transistors are encapsulated in a plastic compound specifically designed for this purpose, using a highly mechanized process‡ developed by Texas Instruments. The case will withstand soldering temperatures without deformation. These devices exhibit stable characteristics under high-humidity conditions and are capable of meeting MIL-STD-202C method 106B. The transistors are insensitive to light.

High thermal-conductivity leads allow operation at unusually high dissipation levels.

Feedback capacitance is minimized by placing the emitter terminal between the base and collector terminals, thus optimizing compatibility with advanced high-frequency design.

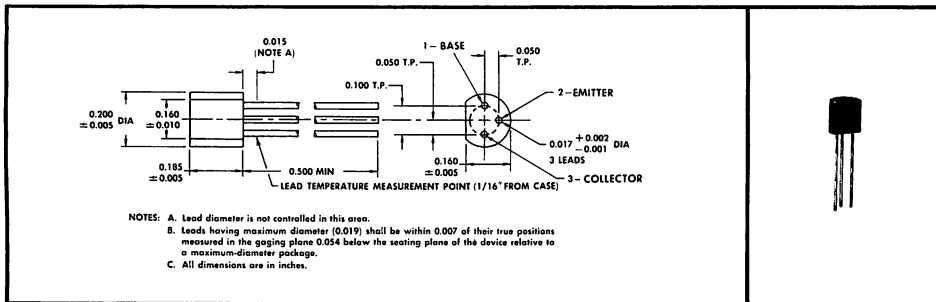

absolute maximum ratings at 25°C free-air temperature (unless otherwise noted)

	TIS86	TIS87
Collector-Base Voltage	30 V	45 V
Collector-Emitter Voltage (See Note 1)	30 V	45 V
Emitter-Base Voltage	4 V	4 V
Continuous Collector Current	← 50 mA →	
Continuous Device Dissipation at (or below) 25°C Free-Air Temperature (See Note 2)	← 400 mW →	
Continuous Device Dissipation at (or below) 25°C Lead Temperature (See Note 3)	← 700 mW →	
Storage Temperature Range	-65°C to 150°C	
Lead Temperature 1/16 Inch from Case for 10 Seconds	← 260°C →	

- NOTES: 1. This value applies when the base-emitter diode is open-circuited.
2. Derate linearly to 150°C free-air temperature at the rate of 3.2 mW/deg.
3. Derate linearly to 150°C lead temperature at the rate of 5.6 mW/deg. Lead temperature is measured on the collector lead 1/16 inch from the case.

†Trademark of Texas Instruments
‡Patent pending



TEXAS INSTRUMENTS
INCORPORATED
POST OFFICE BOX 5012 • DALLAS, TEXAS 75222

TYPES TIS86, TIS87

N-P-N EPITAXIAL PLANAR SILICON TRANSISTORS

electrical characteristics at 25°C free-air temperature (unless otherwise noted)

PARAMETER	TEST CONDITIONS	TIS86			TIS87			UNIT
		MIN	TYP	MAX	MIN	TYP	MAX	
$V_{(BR)CBO}$ Collector-Base Breakdown Voltage	$I_C = 10 \mu A, I_E = 0$	30			45			V
$V_{(BR)CEO}$ Collector-Emitter Breakdown Voltage	$I_C = 10 \text{ mA}, I_B = 0, \text{ See Note 4}$	30			45			V
I_{CBO} Collector Cutoff Current	$V_{CB} = 15 \text{ V}, I_E = 0$			100			100	nA
	$V_{CB} = 15 \text{ V}, I_E = 0, T_A = 85^\circ C$			10			10	μA
I_{EBO} Emitter Cutoff Current	$V_{EB} = 4 \text{ V}, I_C = 0$			10			10	μA
h_{FE} Static Forward Current Transfer Ratio	$V_{CE} = 10 \text{ V}, I_C = 4 \text{ mA}$	40		200				
	$V_{CE} = 12 \text{ V}, I_C = 12 \text{ mA}$				30		150	
V_{BE} Base-Emitter Voltage	$V_{CE} = 12 \text{ V}, I_C = 15 \text{ mA}$			0.87			0.87	V
$V_{CE(sat)}$ Collector-Emitter Saturation Voltage	$I_B = 1.5 \text{ mA}, I_C = 15 \text{ mA}$						0.5	V
$ h_{fe} $ Small-Signal Common-Emitter Forward Current Transfer Ratio	$V_{CE} = 10 \text{ V}, I_C = 4 \text{ mA}, f = 100 \text{ MHz}$	5						
	$V_{CE} = 12 \text{ V}, I_C = 12 \text{ mA}, f = 100 \text{ MHz}$				5			
$ y_{fe} $ Small-Signal Common-Emitter Forward Transfer Admittance	$V_{CE} = 10 \text{ V}, I_C = 4 \text{ mA}, f = 45 \text{ MHz}$	90	115					mmho
	$V_{CE} = 12 \text{ V}, I_C = 12 \text{ mA}, f = 45 \text{ MHz}$				130	200		
ϕ_{yfo} Phase Angle of Small-Signal Common-Emitter Forward Transfer Admittance	$V_{CE} = 10 \text{ V}, I_C = 4 \text{ mA}, f = 45 \text{ MHz}$	-7°	-15°	-20°				
	$V_{CE} = 12 \text{ V}, I_C = 12 \text{ mA}, f = 45 \text{ MHz}$				-18°	-25°	-35°	
C_{ios} Parallel-Equivalent Common-Emitter Short-Circuit Input Capacitance†	$V_{CE} = 10 \text{ V}, I_C = 4 \text{ mA}, f = 200 \text{ MHz}$			9				pF
	$V_{CE} = 12 \text{ V}, I_C = 12 \text{ mA}, f = 45 \text{ MHz}$				25			
C_{ros} Common-Emitter Short-Circuit Reverse Transfer Capacitance†	$V_{CE} = 10 \text{ V}, I_C = 1 \text{ mA}, f = 0.1 \text{ MHz to } 1 \text{ MHz}$	0.33	0.45		0.33	0.45		pF
C_{oes} Parallel-Equivalent Common-Emitter Short-Circuit Output Capacitance†	$V_{CE} = 10 \text{ V}, I_C = 4 \text{ mA}, f = 45 \text{ MHz}$			1.1				pF
	$V_{CE} = 12 \text{ V}, I_C = 12 \text{ mA}, f = 45 \text{ MHz}$				1.1			
$Re(h_{ie})$ Real Part of Small-Signal Common-Emitter Input Impedance	$V_{CE} = 10 \text{ V}, I_C = 4 \text{ mA}, f = 200 \text{ MHz}$	32	60					Ω
	$V_{CE} = 12 \text{ V}, I_C = 12 \text{ mA}, f = 45 \text{ MHz}$				55	100		
$Re(y_{ie})$ Real Part of Small-Signal Common-Emitter Input Admittance	$V_{CE} = 10 \text{ V}, I_C = 4 \text{ mA}, f = 200 \text{ MHz}$	8.5	30					mmho
	$V_{CE} = 12 \text{ V}, I_C = 12 \text{ mA}, f = 45 \text{ MHz}$				5	12		
$Re(y_{oe})$ Real Part of Small-Signal Common-Emitter Output Admittance	$V_{CE} = 10 \text{ V}, I_C = 4 \text{ mA}, f = 45 \text{ MHz}$	0.02	0.15					mmho
	$V_{CE} = 12 \text{ V}, I_C = 12 \text{ mA}, f = 45 \text{ MHz}$				0.07	0.2		

NOTE 4: This parameter must be measured using pulse techniques. $t_p = 300 \mu s$, duty cycle $\leq 2\%$.

† C_{ios} , C_{ros} , and C_{oes} are defined as the imaginary parts of the small-signal, common-emitter, short-circuit admittances divided by $2\pi f$.

operating characteristics at 25°C free-air temperature

PARAMETER	TEST CONDITIONS	TIS86		UNIT
		TYP	MAX	
NF Spot Noise Figure	$V_{CE} = 10 \text{ V}, I_C = 4 \text{ mA}, R_G = 50 \Omega, f = 200 \text{ MHz}$	2.5	5	dB

TYPES TIS86, TIS87 N-P-N EPITAXIAL PLANAR SILICON TRANSISTORS

TYPICAL CHARACTERISTICS

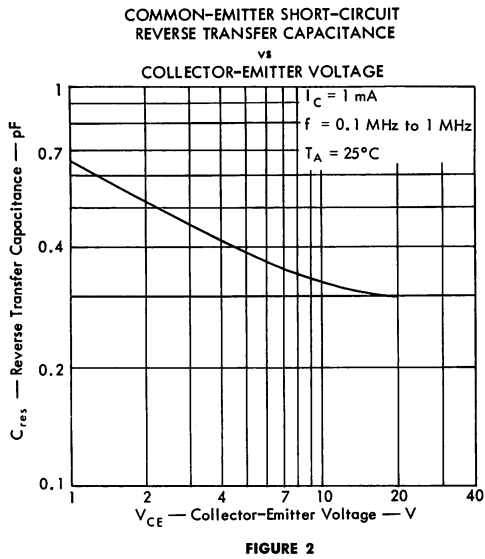
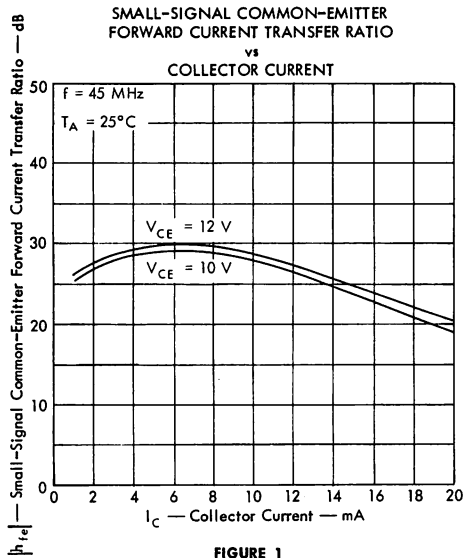

TYPES TIS86, TIS87

N-P-N EPITAXIAL PLANAR SILICON TRANSISTORS

TYPICAL CHARACTERISTICS

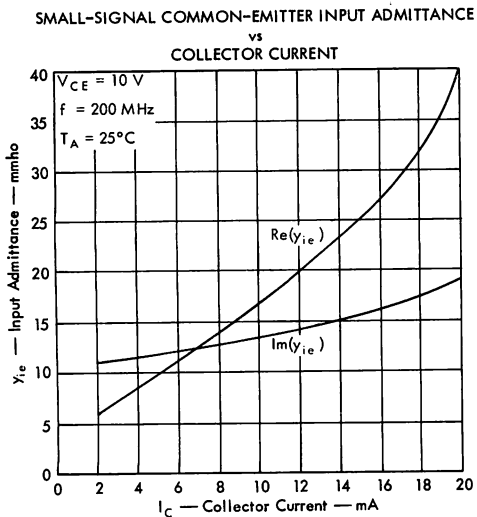

FIGURE 3

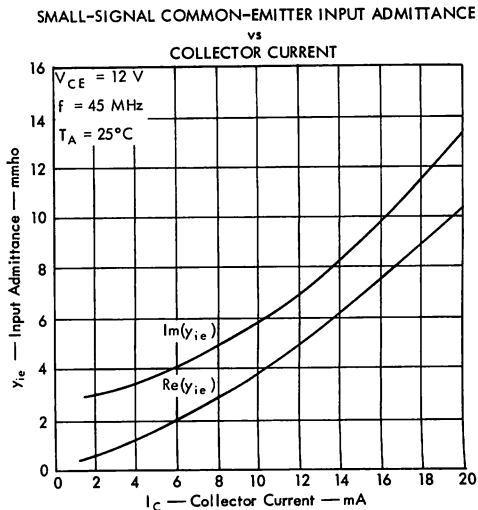

FIGURE 4

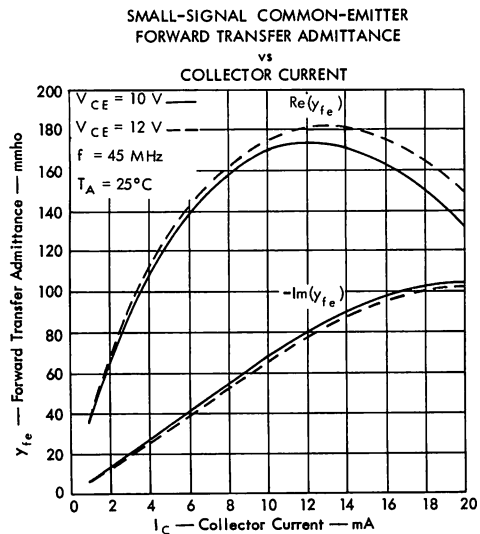

FIGURE 5

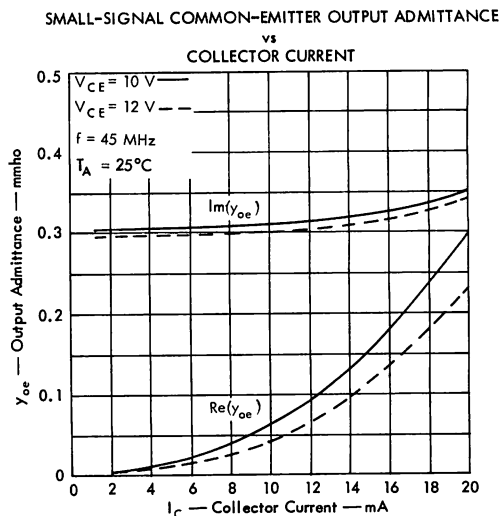

FIGURE 6

TYPES T1S86, T1S87 N-P-N EPITAXIAL PLANAR SILICON TRANSISTORS

TYPICAL APPLICATION DATA

TYPICAL TV VHF TUNER PERFORMANCE			
CHANNEL	POWER GAIN	NOISE FIGURE	IF REJECT
2	39	5.5	55
3	38	5.2	55
4	38	5.7	57
5	36	5.5	59
6	38	6.0	63
7	37	5.5	72
8	35	6.1	71
9	36	5.5	72
10	34	5.5	84
11	35	6.2	79
12	35	6.2	76
13	35	6.1	65

POWER SUPPLY INFORMATION			
Power Supply	MAXIMUM GAIN	MINIMUM GAIN	UNIT
12 V at 19.5 mA	12 V at 19.5 mA	12 V at 34 mA	dB
V _{AEC} Supply	1.8 V at 0.1 mA	8 V at 2.85 mA	dB

TYPICAL TUNER AND IF AMPLIFIER (SEE FIG. 13) COMBINED PERFORMANCE			
CHANNEL	V _{in(frf)}	UNIT	
2		3.5	
3		3.5	
4		3.5	
5		4.5	
6		3.5	
7		11.0	
8		10.0	
9		9.0	
10		13.0	
11		12.0	
12		9.5	
13		11.0	

Frequency Rejection:			
39.75 MHz:	down	13.5 dB	
41.25 MHz:	down	13.5 dB	
41.80 MHz:	down	6 dB	
45.75 MHz:	down	6 dB	
47.25 MHz:	down	46.5 dB	

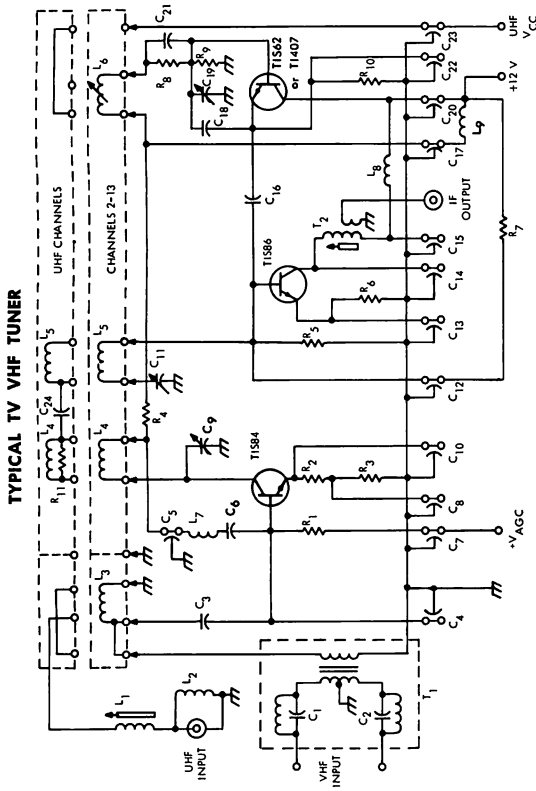

CIRCUIT COMPONENT INFORMATION

CAPACITORS

- C₁: 47 pF
- C₂: 47 pF
- C₃: 6.2 pF
- C₄: 18 pF feed-thru
- C₅: 30 pF feed-thru
- C₆: 0.68 pF
- C₇: 1000 pF feed-thru
- C₈: 1000 pF feed-thru
- C₉: 2-8 pF air trimmer
- C₁₀: 39 pF feed-thru
- C₁₁: 2-8 pF air trimmer
- C₁₂: 30 pF feed-thru
- C₁₃: 1000 pF feed-thru
- C₁₄: 10 pF feed-thru
- C₁₅: 1000 pF feed-thru
- C₁₆: 3.6 pF
- C₁₇: 1000 pF feed-thru
- C₁₈: 5.6 pF
- C₁₉: 0.5-3 pF air trimmer
- C₂₀: 1000 pF feed-thru
- C₂₁: 5.6 pF
- C₂₂: 2.5 pF feed-thru
- C₂₃: 1000 pF feed-thru
- C₂₄: 5.6 pF

RESISTORS (1/2 W, ten percent)

- R₁: 1 kΩ
- R₂: 10 kΩ
- R₃: 5.6 kΩ
- R₄: 15 Ω
- R₅: 360 Ω
- R₆: 390 Ω
- R₇: 1.2 kΩ
- R₈: 10 kΩ
- R₉: 1 kΩ
- R₁₀: 1 kΩ
- R₁₁: 10 kΩ
- R₁₂: 220 Ω

TRANSFORMERS

- T₁: balun assembly, including IF traps
- T₂: IF output transformer

INDUCTORS

- L₁: UHF matching coil
- L₂: UHF matching coil
- L₃: as required per channel
- L₄: as required per channel
- L₅: as required per channel
- L₆: as required per channel
- L₇: neutralizing coil
- L₈: REC
- L₉: REC

FIGURE 12 — TYPICAL TV VHF TUNER

TYPES TIS86, TIS87 N-P-N EPITAXIAL PLANAR SILICON TRANSISTORS

TYPICAL APPLICATION DATA

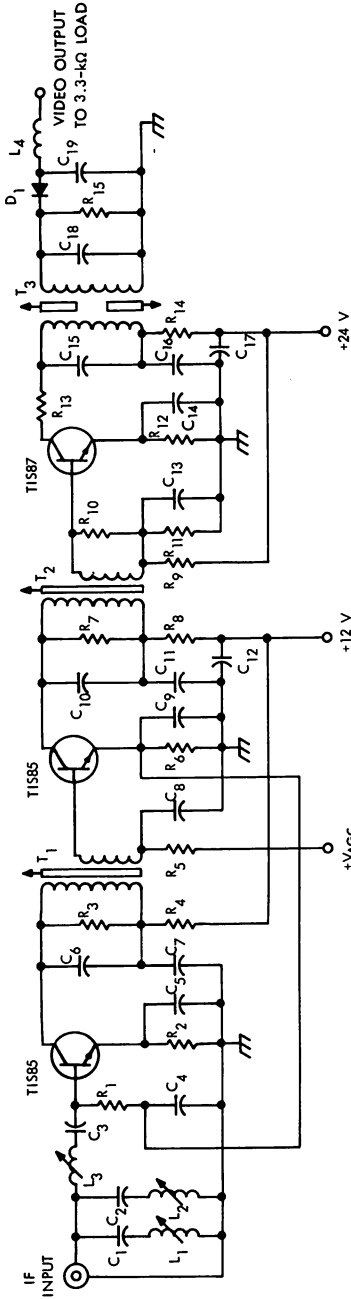

CIRCUIT COMPONENT INFORMATION

RESISTORS (1/2 W, TEN PERCENT)

R ₁ : 20 Ω	R ₅ : 680 Ω	R ₁₁ : 4.7 kΩ
R ₂ : 470 Ω	R ₇ : 1 kΩ	R ₁₂ : 510 Ω
R ₃ : 1 kΩ	R ₈ : 270 Ω	R ₁₃ : 56 Ω
R ₄ : 270 Ω	R ₉ : 15 kΩ	R ₁₄ : 220 Ω
R ₅ : 1 kΩ	R ₁₀ : 20 Ω	R ₁₅ : 5.6 kΩ

CAPACITORS

C ₁ : 8.2 pF	C ₁₁ : 0.002 μF	C ₆ : 0.002 μF
C ₂ : 10 pF	C ₁₂ : 0.002 μF	C ₇ : 0.002 μF
C ₃ : 18 pF	C ₁₃ : 0.002 μF	C ₈ : 18 pF
C ₄ : 0.002 μF	C ₁₄ : 0.002 μF	C ₉ : 10 pF
C ₅ : 0.002 μF	C ₁₅ : 15 pF	

DIODE

D₁: 1N60

INDUCTORS

- L₁: self sound, 14 T, #27 enameled, close-wound, 9/32" OD form, Arnold Eng. core type "J"
- L₂: adjacent sound, 10 T, #27 enameled, close-wound, 9/32" OD form, Arnold Eng. core type "J"
- L₃: series inductor, 6 T, #27 enameled, close-wound, 9/32" OD form, Arnold Eng. core type "J"
- L₄: filter inductor, 10 μH, Delevan RFC

TRANSFORMERS

- T₁: pri.: 6T, sec.: 2 T, #27 enameled, close-wound, bifilar, 9/32" OD form, Arnold Eng. core type "J"
- T₂: pri.: 8T, sec.: 2 T, #27 enameled, close-wound, bifilar, 9/32" OD form, Arnold Eng. core type "J"
- T₃: pri.: 9T, sec.: 8 T, #25 enameled, close-wound, pri. and sec. spacings: 0.18", 9/32" OD form, Arnold Eng. core type "J"

POWER SUPPLY INFORMATION

	MAXIMUM GAIN	MINIMUM GAIN
Power Supply	12 V at 9 mA	12 V at 20 mA
V _{acc} Supply	24 V at 10 mA	24 V at 10 mA
	4 V at 0 mA	7.5 V at 0.5 mA

TYPICAL TV IF AMPLIFIER PERFORMANCE

Sensitivity: V_{in(f)} = 100 μV for V_{out(oc)} = 1 V

Frequency Rejection:

39.75 MHz:	down 17 dB
41.25 MHz:	down 20 dB
45.75 MHz:	down 3 dB
47.25 MHz:	down 18 dB

FIGURE 13 — TYPICAL TV IF AMPLIFIER

TYPES TIS94, TIS95, TIS96, TIS97, TIS98, TIS99 N-P-N EPITAXIAL PLANAR SILICON TRANSISTORS



TYPES TIS94 THRU TIS99
BULLETIN NO. DL-5 6710187, JUNE 1967

A COMPLETE FAMILY OF LOW-NOISE, LOW- TO MEDIUM-CURRENT SILECT† TRANSISTORS FOR USE IN HI-FI AUDIO AMPLIFIERS AND GENERAL PURPOSE LOW-FREQUENCY APPLICATIONS

- High $V_{(BR)CEO} \dots 65 \text{ V Min (TIS96 and TIS99)}$
- Excellent h_{FE} Linearity to 100 mA

mechanical data

These transistors are encapsulated in a plastic compound specifically designed for this purpose, using a highly mechanized process developed by Texas Instruments. The case will withstand soldering temperatures without deformation. These devices exhibit stable characteristics under high-humidity conditions and are capable of meeting MIL-STD-202C method 106B. The transistors are insensitive to light.

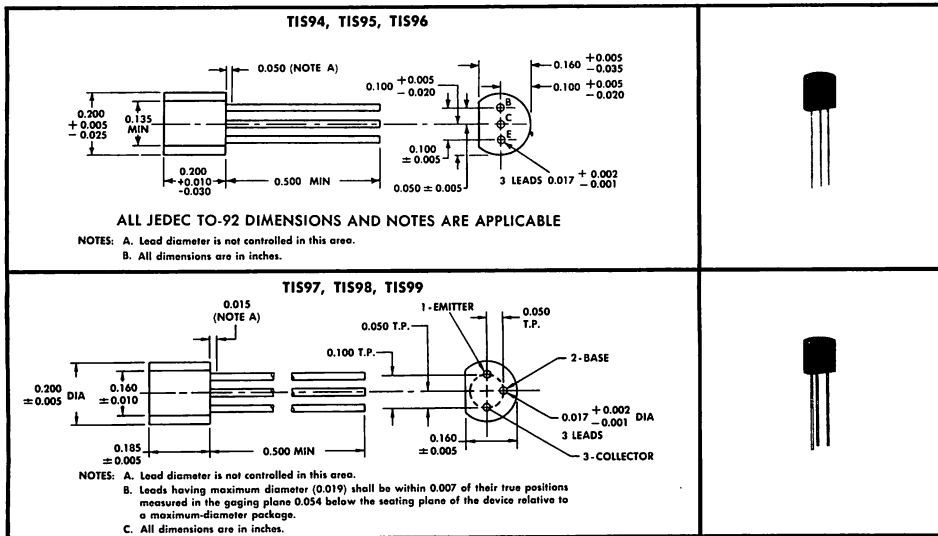

absolute maximum ratings at 25°C free-air temperature (unless otherwise noted)

	TIS94	TIS95	TIS96
	TIS97	TIS98	TIS99
Collector-Base Voltage	60 V	80 V	80 V
Collector-Emitter Voltage (See Note 1)	40 V	60 V	65 V
Emitter-Base Voltage	6 V	6 V	6 V
Continuous Collector Current	← 200 mA →		
Continuous Device Dissipation at (or below) 25°C Free-Air Temperature (See Note 2)	← 360 mW →		
Continuous Device Dissipation at (or below) 25°C Lead Temperature (See Note 3)	← 500 mW →		
Storage Temperature Range	← 65°C to 150°C →		
Lead Temperature 1/16 Inch from Case for 10 Seconds	← 260°C →		

- NOTES: 1. These values apply between 0 and 10 mA collector current when the base-emitter diode is open-circuited.
 2. Derate linearly to 150°C free-air temperature at the rate of 2.88 mW/deg.
 3. Derate linearly to 150°C lead temperature at the rate of 4 mW/deg. Lead temperature is measured on the collector lead 1/16 inch from the case.

†Trademark of Texas Instruments
‡Patent pending

TYPES TIS94 THRU TIS99

N-P-N EPITAXIAL PLANAR SILICON TRANSISTORS

electrical characteristics at 25°C free-air temperature

PARAMETER	TEST CONDITIONS	TIS94 TIS97			TIS95 TIS98			TIS96 TIS99			UNIT
		MIN	TYP	MAX	MIN	TYP	MAX	MIN	TYP	MAX	
$V_{(BR)CEO}$ Collector-Emitter Breakdown Voltage	$I_C = 10 \text{ mA}, I_B = 0,$ See Note 4	40			60			65			V
I_{CBO} Collector Cutoff Current	$V_{CB} = 40 \text{ V}, I_E = 0$		10			10			10		nA
	$V_{CB} = 60 \text{ V}, I_E = 0$			10							μA
I_{EBO} Emitter Cutoff Current	$V_{CB} = 80 \text{ V}, I_E = 0$					10			10		μA
	$V_{EB} = 6 \text{ V}, I_C = 0$			20		20			20		nA
h_{FE} Static Forward Current Transfer Ratio	$V_{CE} = 5 \text{ V}, I_C = 100 \mu\text{A}$	250	340	700							
	$V_{CE} = 5 \text{ V}, I_C = 1 \text{ mA}$				100	200	300				
	$V_{CE} = 5 \text{ V}, I_C = 10 \text{ mA},$ See Note 4							60	125		
	$V_{CE} = 5 \text{ V}, I_C = 100 \text{ mA},$ See Note 4							55	110	300	
V_{BE} Base-Emitter Voltage	$V_{CE} = 5 \text{ V}, I_C = 100 \mu\text{A}$	0.45	0.65								V
	$V_{CE} = 5 \text{ V}, I_C = 1 \text{ mA}$				0.5	0.7					V
	$V_{CE} = 5 \text{ V}, I_C = 10 \text{ mA},$ See Note 4							0.6	0.8		V
V_{CE} Collector-Emitter Voltage	$I_B = 0.1 \text{ mA}, I_C = 10 \text{ mA},$ See Note 4					1					V
	$I_B = 2 \text{ mA}, I_C = 100 \text{ mA},$ See Note 4								2		V
$V_{CE(sat)}$ Collector-Emitter Saturation Voltage	$I_B = 5 \text{ mA}, I_C = 100 \text{ mA},$ See Note 4					0.5			0.5		V
h_{ie} Small-Signal Common-Emitter Input Impedance	$V_{CE} = 5 \text{ V}, I_C = 100 \mu\text{A}$	115									$\text{k}\Omega$
	$V_{CE} = 5 \text{ V}, I_C = 1 \text{ mA}$				6.4						
	$V_{CE} = 5 \text{ V}, I_C = 10 \text{ mA}$							0.5			
h_{fo} Small-Signal Common-Emitter Forward Current Transfer Ratio	$V_{CE} = 5 \text{ V}, I_C = 100 \mu\text{A}$	250	440	800							
	$V_{CE} = 5 \text{ V}, I_C = 1 \text{ mA}$				100	240	400				
	$V_{CE} = 5 \text{ V}, I_C = 10 \text{ mA}$							60	130	500	
h_{re} Small-Signal Common-Emitter Reverse Voltage Transfer Ratio	$V_{CE} = 5 \text{ V}, I_C = 100 \mu\text{A}$	30×10^{-4}									
	$V_{CE} = 5 \text{ V}, I_C = 1 \text{ mA}$				1.5×10^{-4}						
	$V_{CE} = 5 \text{ V}, I_C = 10 \text{ mA}$							0.9×10^{-4}			
h_{oo} Small-Signal Common-Emitter Output Admittance	$V_{CE} = 5 \text{ V}, I_C = 100 \mu\text{A}$	11									μmho
	$V_{CE} = 5 \text{ V}, I_C = 1 \text{ mA}$				6						
	$V_{CE} = 5 \text{ V}, I_C = 10 \text{ mA}$							50			
Y_{fe} Small-Signal Common-Emitter Forward Transfer Admittance	$V_{CE} = 5 \text{ V}, I_C = 100 \mu\text{A}$	3.8									mmho
	$V_{CE} = 5 \text{ V}, I_C = 1 \text{ mA}$				30			38			
	$V_{CE} = 5 \text{ V}, I_C = 10 \text{ mA}$							260			
$ h_{fe} $ Small-Signal Common-Emitter Forward Current Transfer Ratio	$V_{CE} = 5 \text{ V}, I_C = 10 \text{ mA},$ $f = 100 \text{ MHz}$	2			2			2			
C_{cb} Collector-Base Capacitance	$V_{CB} = 5 \text{ V}, I_E = 0,$ $f = 1 \text{ MHz},$ See Note 5	1	4		1	4		1	4		pF
C_{ob} Emitter-Base Capacitance	$V_{EB} = 0.5 \text{ V}, I_C = 0,$ $f = 1 \text{ MHz},$ See Note 5		16			16			16		pF

operating characteristics at 25°C free-air temperature

PARAMETER	TEST CONDITIONS	TIS94, TIS97		UNIT
		MAX		
NF Spot Noise Figure	$V_{CE} = 5 \text{ V}, I_C = 30 \mu\text{A},$ $R_G = 10 \text{ k}\Omega,$ $f = 1 \text{ kHz},$ Noise Bandwidth = 100 Hz	2		dB
$\overline{\text{NF}}$ Average Noise Figure	$V_{CE} = 5 \text{ V}, I_C = 100 \mu\text{A},$ Noise Bandwidth = 15.7 kHz, $R_G = 10 \text{ k}\Omega,$ See Note 6	3		dB

NOTES: 4. These parameters must be measured using pulse techniques. $t_p = 300 \mu\text{s}$, duty cycle $\leq 2\%$.

5. C_{cb} and C_{ob} are measured using three-terminal measurement techniques with the third electrode (emitter or collector respectively) guarded.

6. Average Noise Figure is measured in an amplifier with response down 3 dB at 10 Hz and 10 kHz and a high-frequency rolloff of 6 dB/octave.

TYPES TIS94 THRU TIS99 N-P-N EPITAXIAL PLANAR SILICON TRANSISTORS

PARAMETER COLOR-CODE INFORMATION

The TIS96 and TIS99 are furnished in three color-coded h_{FE} brackets, each having a 2-to-1 spread as shown in the table below. No h_{FE} -bracket distribution is implied by this coding system.

COLOR CODE	h_{FE} BRACKET
red	$V_{CE} = 5 V, I_C = 100 \text{ mA}$
orange	55–110
yellow	90–180
	150–300

TABLE 1 — TIS96, TIS99 h_{FE} BRACKETS

TYPICAL CHARACTERISTICS

TIS94, TIS97

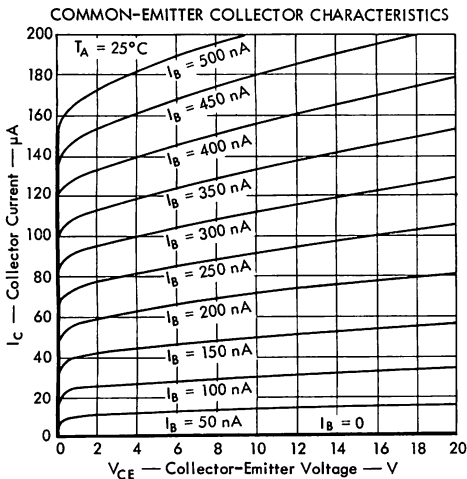

FIGURE 1

TIS96, TIS99

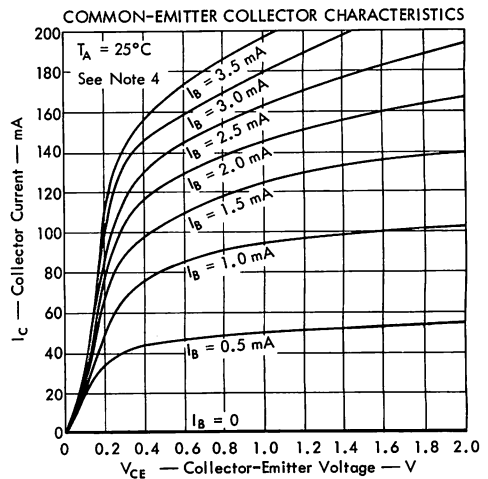
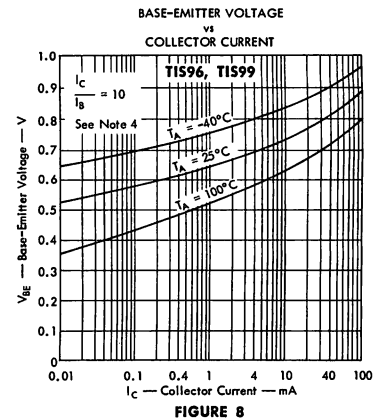
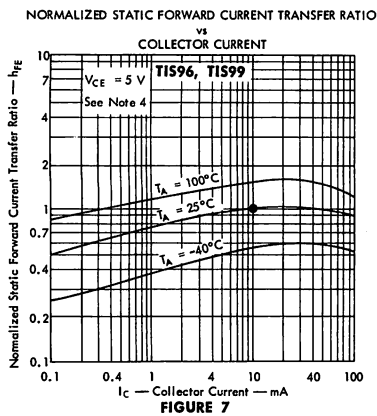
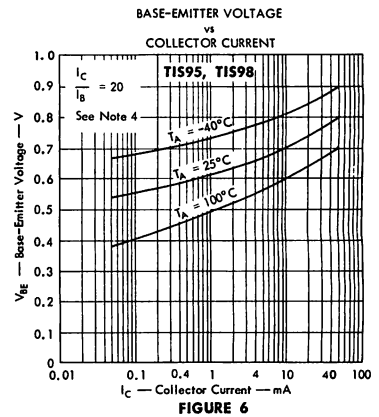
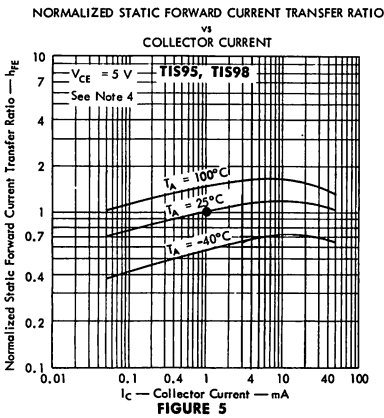
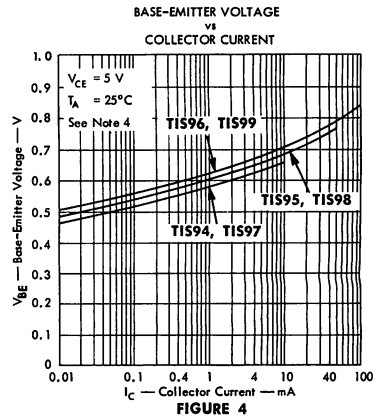
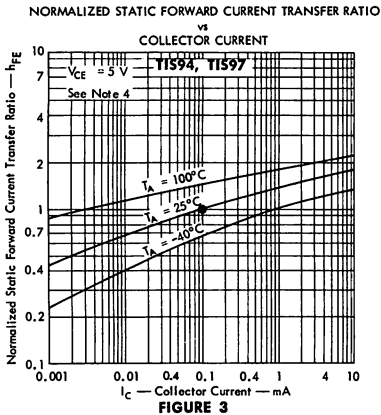

FIGURE 2

NOTE 4: These parameters must be measured using pulse techniques. $t_p = 300 \mu\text{s}$, duty cycle $\leq 2\%$.

TYPES TIS94 THRU TIS99 N-P-N EPITAXIAL PLANAR SILICON TRANSISTORS

TYPICAL CHARACTERISTICS



NOTE 4: These parameters must be measured using pulse techniques. $t_p = 300\ \mu\text{s}$, duty cycle $\leq 2\%$.

TYPES TIS94 THRU TIS99 N-P-N EPITAXIAL PLANAR SILICON TRANSISTORS

TYPICAL CHARACTERISTICS

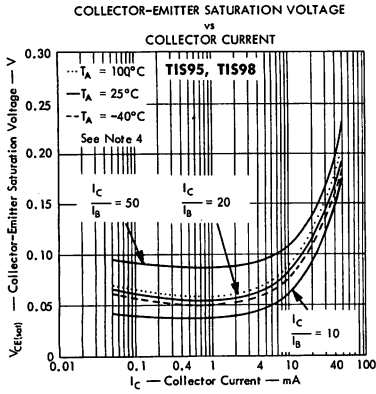

FIGURE 9

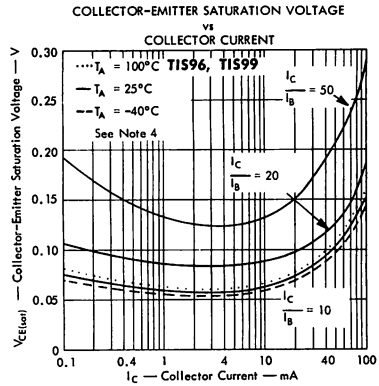

FIGURE 10

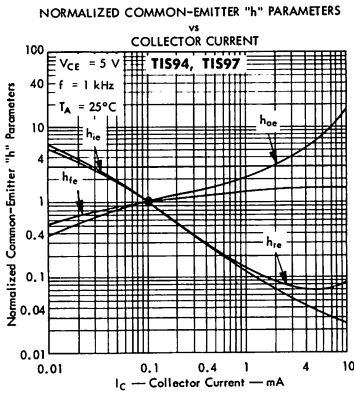

FIGURE 11

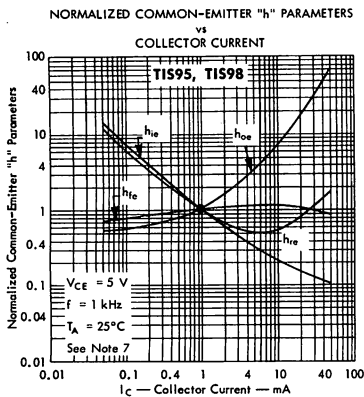

FIGURE 12

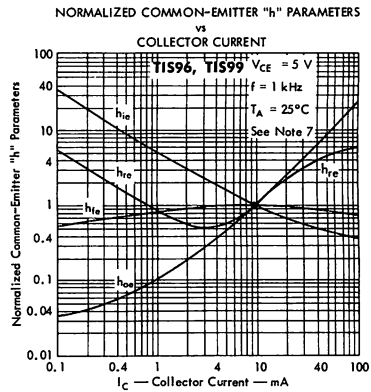

FIGURE 13

NOTES: 4. These parameters must be measured using pulse techniques. $I_p = 300\ \mu\text{s}$, duty cycle $\leq 2\%$.

7. These parameters are measured with bias voltages applied for less than five seconds to avoid overheating the transistor.

TYPES T1S94 THRU T1S99 N-P-N EPITAXIAL PLANAR SILICON TRANSISTORS

TYPICAL CHARACTERISTICS

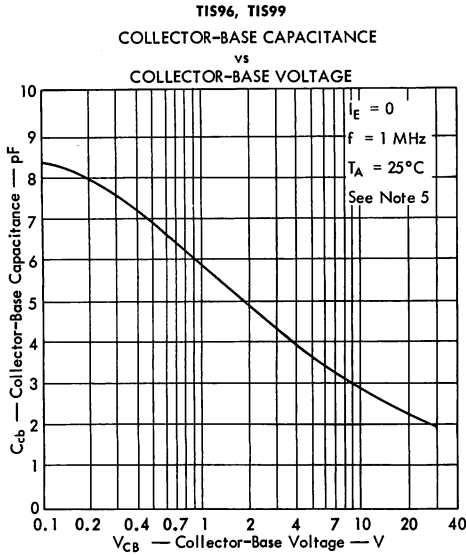

FIGURE 14

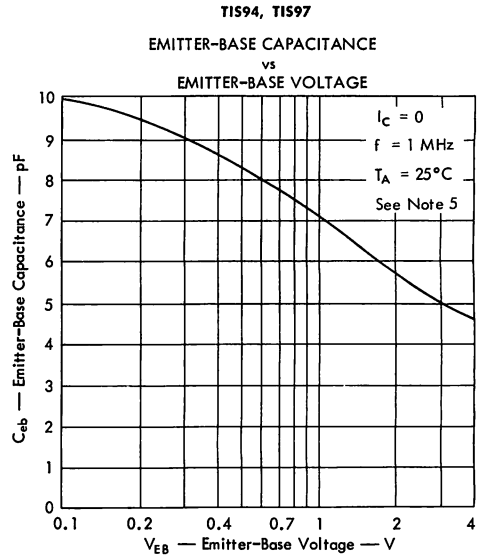

FIGURE 15

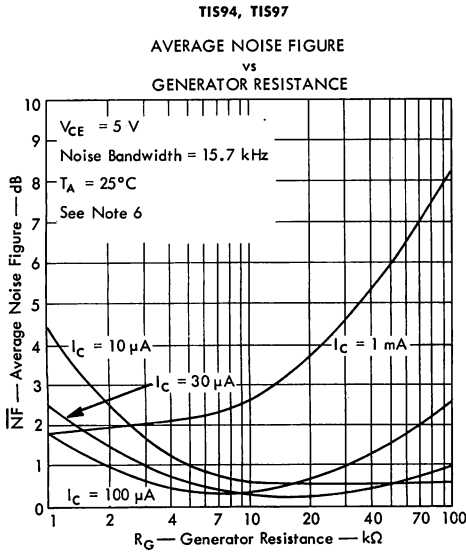

FIGURE 16

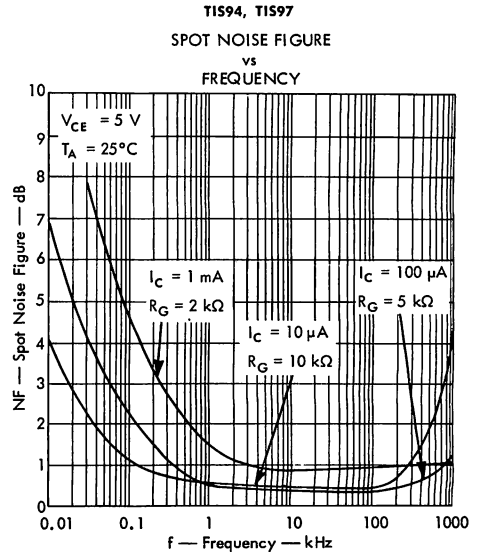

FIGURE 17

NOTES: 5. C_{cb} and C_{eb} are measured using three-terminal measurement techniques with the third electrode (emitter or collector respectively) guarded.
6. Average Noise Figure is measured in an amplifier with response down 3 dB at 10 Hz and 10 kHz and a high-frequency rolloff of 6 dB/octave.

TYPES TIS94 THRU TIS99 N-P-N EPITAXIAL PLANAR SILICON TRANSISTORS

TYPICAL CHARACTERISTICS

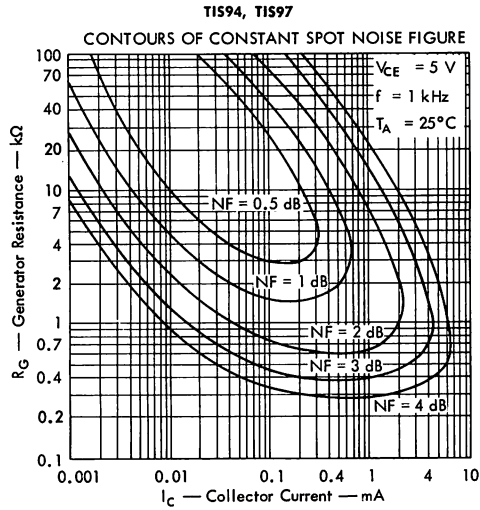

FIGURE 18

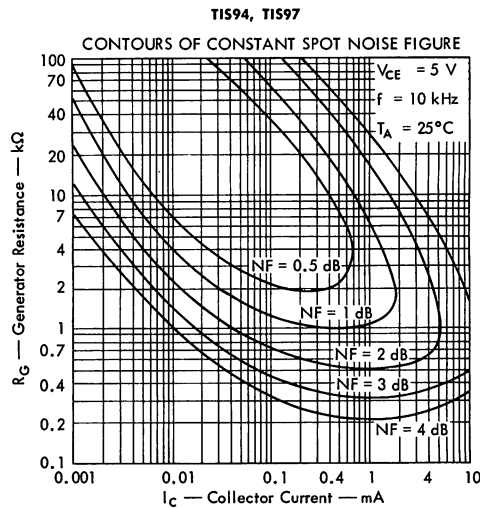
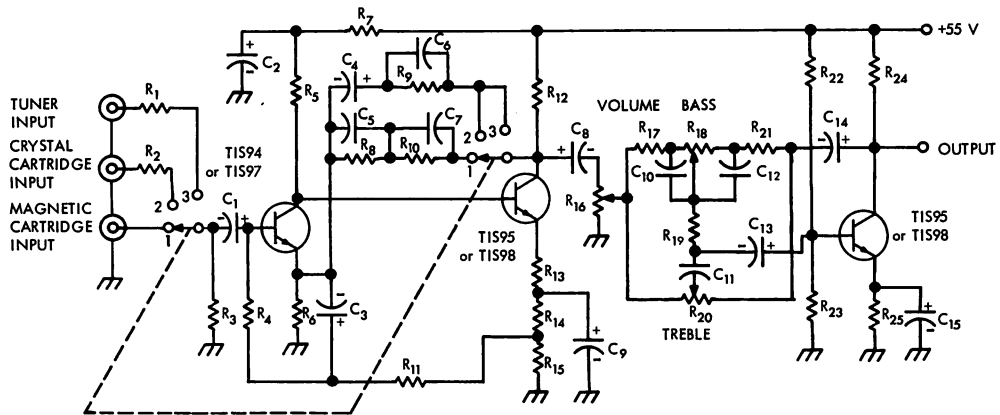

FIGURE 19

TYPES TIS94 THRU TIS99 N-P-N EPITAXIAL PLANAR SILICON TRANSISTORS

TYPICAL APPLICATION DATA



CIRCUIT COMPONENT INFORMATION

RESISTORS

R ₁ : 1 MΩ	R ₁₀ : 56 kΩ	R ₁₈ : 0-1 MΩ
R ₂ : 2.7 MΩ	R ₁₁ : 100 kΩ	R ₁₉ : 47 kΩ
R ₃ : 47 kΩ	R ₁₂ : 33 kΩ	R ₂₀ : 0-500 kΩ
R ₄ : 100 kΩ	R ₁₃ : 270 Ω	R ₂₁ : 82 kΩ
R ₅ : 150 kΩ	R ₁₄ : 2.2 kΩ	R ₂₂ : 470 kΩ
R ₆ : 330 Ω	R ₁₅ : 1 kΩ	R ₂₃ : 56 kΩ
R ₇ : 15 kΩ	R ₁₆ : 0-100 kΩ	R ₂₄ : 39 kΩ
R ₈ : 1.2 MΩ	R ₁₇ : 82 kΩ	R ₂₅ : 4.7 kΩ
R ₉ : 75 kΩ		

CAPACITORS

C ₁ : 10 μF, 3 V, electrolytic	C ₉ : 50 μF, 6 V, electrolytic
C ₂ : 2 μF, 50 V, electrolytic	C ₁₀ : 0.003 μF
C ₃ : 50 μF, 3 V, electrolytic	C ₁₁ : 470 pF
C ₄ : 20 μF, 25 V, electrolytic	C ₁₂ : 0.003 μF
C ₅ : 0.0033 μF	C ₁₃ : 5 μF, 6 V, electrolytic
C ₆ : 47 pF	C ₁₄ : 1 μF, 25 V, electrolytic
C ₇ : 1200 pF	C ₁₅ : 20 μF, 6 V, electrolytic
C ₈ : 1 μF, 50 V, electrolytic	

All resistors 1/2 W, ten percent tolerance

TYPICAL PERFORMANCE AT RATED OUTPUT	
$V_{out}=1$ V, $R_L=22$ kΩ, $f=1$ kHz (unless otherwise noted), $T_A=25^\circ$ C	
Sensitivity:	
Magnetic Cartridge Input	4 mV
Crystal Cartridge Input	220 mV
Tuner Input	100 mV
Total Harmonic Distortion:	
Magnetic Cartridge Input	0.06%
Crystal and Tuner Inputs	0.14%
Unweighted Noise Below 1 V rms	
With Grounded Input	72 dB
Frequency Response:	
Crystal and Tuner Inputs	±1 dB
Overload Capability:	
Magnetic Cartridge Input	35 to 50 mV†
Crystal Cartridge Input	2 to 2.8 V†
Tuner Input	0.9 to 1.3 V†
Input Impedance:	
Magnetic Cartridge Input	47 kΩ
Crystal Cartridge Input	2.7 MΩ
Tuner Input	1 MΩ
RIAA Compensation (Magnetic Input Only)	
Within ±1 dB of Ideal Curve from	20 Hz to 20 kHz
†Value dependent on volume control setting	

FIGURE 20 — TYPICAL AUDIO PREAMPLIFIER

TYPES 2N696, 2N697, 2N717, 2N718, 2N718A, 2N730, 2N731, 2N956, 2N1420, 2N1507, 2N1613, 2N1711

N-P-N DOUBLE-DIFFUSED PLANAR SILICON TRANSISTORS



TYPES 2N696, 2N697, 2N717, 2N718, 2N718A, 2N730, 2N731, 2N956, 2N1420, 2N1507, 2N1613, 2N1711 BULLETIN NO. DL-5 683471 MAY 1968 REVISED MAY 1968

Highly Reliable, Versatile Devices Designed for Amplifier, Switching and Oscillator Applications from <0.1 ma to >150 ma, dc to 30 mc

- High Voltage • Low Leakage
- Useful h_{FE} Over Wide Current Range

*mechanical data

Device types 2N717, 2N718, 2N718A, 2N730, 2N731, and 2N956 are in JEDEC TO-18 packages.
Device types 2N696, 2N697, 2N1420, 2N1507, 2N1613, and 2N1711 are in JEDEC TO-5 packages.

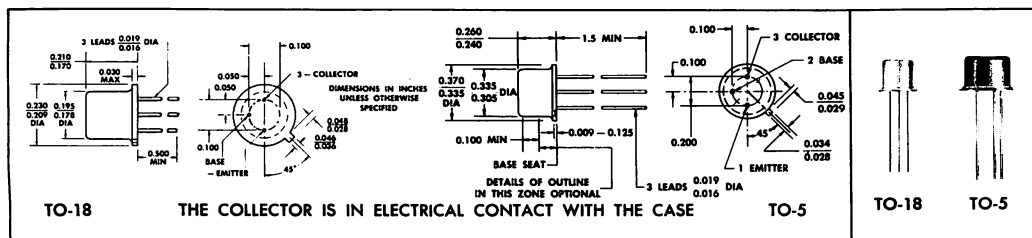

*absolute maximum ratings at 25°C free-air temperature (unless otherwise noted)

	2N696 2N697	2N717 2N718	2N718A	2N730 2N731	2N956	2N1420 2N1507	2N1613	2N1711	UNIT
Collector-Base Voltage	60	60	75	60	75	60	75	75	v
Collector-Emitter Voltage (See Note 1)	40	40	50	40	50	30	50	50	v
Collector-Emitter Voltage (See Note 2)			32						v
Emitter-Base Voltage	5	5	7	5	7	5	7	7	v
Collector Current				1.0		1.0		1.0	a
Total Device Dissipation at (or below) 25°C Free-Air Temperature (See Note Indicated in Parentheses) →	0.6 † (3)	0.4 †† (5)	0.5 (7)	0.5 †† (9)	0.5 (7)	0.6 † (3)	0.8 (10)	0.8 (10)	w
Total Device Dissipation at (or below) 25°C Case Temperature (See Note Indicated in Parentheses) →	2.0 † (4)	1.5 †† (6)	1.8 (8)	1.5 †† (6)	1.8 (8)	2.0 † (4)	3.0 (11)	3.0 (11)	w
Total Device Dissipation at 100°C Case Temperature	1.0 †	0.75 ††	1.0	0.75 ††	1.0	1.0 †	1.7	1.7	w
Operating Collector Junction Temperature	175†	175††	200	175††	200	175†	200	200	°C
Storage Temperature Range	-65°C to 200°C								

- NOTES: 1. This value applies when the base-emitter resistance (R_{BE}) is equal to or less than 10 ohms.
2. This value applies when the base-emitter diode is open-circuited.
3. Derate linearly to 175°C free-air temperature at the rate of 4.0 mw/°C.
4. Derate linearly to 175°C case temperature at the rate of 13.3 mw/°C.
5. Derate linearly to 175°C free-air temperature at the rate of 2.67 mw/°C.
6. Derate linearly to 175°C case temperature at the rate of 10.0 mw/°C.
7. Derate linearly to 200°C free-air temperature at the rate of 2.86 mw/°C.
8. Derate linearly to 200°C case temperature at the rate of 10.3 mw/°C.
9. Derate linearly to 175°C free-air temperature at the rate of 3.33 mw/°C.
10. Derate linearly to 200°C free-air temperature at the rate of 4.56 mw/°C.
11. Derate linearly to 200°C case temperature at the rate of 17.2 mw/°C.

- †Texas Instruments guarantees its types 2N696, 2N697, 2N1420, and 2N1507 to be capable of the same dissipation as registered and shown for types 2N1613 and 2N1711 with appropriate derating factors shown in Notes 10 and 11. See derating curves, page 8.
- ††Texas Instruments guarantees its types 2N717, 2N718, 2N730, and 2N731 to be capable of the same dissipation as registered and shown for types 2N718A and 2N956 with appropriate derating factors shown in Notes 7 and 8. See derating curves, page 8.

*Indicates JEDEC registered data.

**TYPES 2N696, 2N697, 2N717, 2N718, 2N718A, 2N730,
2N731, 2N956, 2N1420, 2N1507, 2N1613, 2N1711
N-P-N DOUBLE-DIFFUSED PLANAR SILICON TRANSISTORS**

*electrical characteristics at 25°C free-air temperature (unless otherwise noted)

PARAMETER	TEST CONDITIONS	TO-18 →		2N717 2N730		2N718 2N731		UNIT	
		TO-5 →		2N696		2N697			
		MIN	MAX	MIN	MAX	MIN	MAX		
V_{CB0} Collector-Base Breakdown Voltage	$I_C = 100 \mu\text{a}, I_E = 0$	60		60		60	60	v	
V_{CEO} Collector-Emitter Breakdown Voltage	$I_C = 30 \text{ ma}, I_B = 0$, See Note 12							v	
V_{CEr} Collector-Emitter Breakdown Voltage	$I_C = 100 \text{ ma}, R_{BE} = 10 \Omega$, See Note 12	40		40		40	40	v	
V_{EBO} Emitter-Base Breakdown Voltage	$I_E = 100 \mu\text{a}, I_C = 0$ Except 2N717, 2N718: $I_E = 1 \text{ ma}$	5		5		5	5	v	
I_{CBO} Collector Cutoff Current	$V_{CB} = 30 \text{ v}, I_E = 0$	1.0		1.0		1.0	1.0	μa	
	$V_{CB} = 30 \text{ v}, I_E = 0, T_A = 150^\circ\text{C}$	100		100		100	100	μa	
	$V_{CB} = 60 \text{ v}, I_E = 0$							μa	
	$V_{CB} = 60 \text{ v}, I_E = 0, T_A = 150^\circ\text{C}$							μa	
I_{CER} Collector Cutoff Current	$V_{CE} = 20 \text{ v}, R_{BE} = 100 \text{ k}\Omega$							μa	
I_{EBO} Emitter Cutoff Current	$V_{EB} = 5 \text{ v}, I_C = 0$							μa	
h_{FE} Static Forward Current Transfer Ratio	$V_{CE} = 10 \text{ v}, I_C = 10 \mu\text{a}$								
	$V_{CE} = 10 \text{ v}, I_C = 100 \mu\text{a}$								
	$V_{CE} = 10 \text{ v}, I_C = 10 \text{ ma}$, See Note 12								
	$V_{CE} = 10 \text{ v}, I_C = 10 \text{ ma}, T_A = -55^\circ\text{C}$ See Note 12								
	$V_{CE} = 10 \text{ v}, I_C = 150 \text{ ma}$, See Note 12	20	60	40	120	20	60	40	120
	$V_{CE} = 10 \text{ v}, I_C = 500 \text{ ma}$, See Note 12								
V_{BE} Base-Emitter Voltage	$I_B = 15 \text{ ma}, I_C = 150 \text{ ma}$, See Note 12	1.3		1.3		1.3	1.3	v	
$V_{CE(sat)}$ Collector-Emitter Saturation Voltage	$I_B = 15 \text{ ma}, I_C = 150 \text{ ma}$, See Note 12	1.5		1.5		1.5	1.5	v	
h_{ib} Small-Signal Common-Base Input Impedance	$V_{CB} = 5 \text{ v}, I_C = 1 \text{ ma}, f = 1 \text{ kc}$							ohm	
	$V_{CB} = 10 \text{ v}, I_C = 5 \text{ ma}, f = 1 \text{ kc}$							ohm	
h_{rb} Small-Signal Common-Base Reverse Voltage Transfer Ratio	$V_{CB} = 5 \text{ v}, I_C = 1 \text{ ma}, f = 1 \text{ kc}$								
	$V_{CB} = 10 \text{ v}, I_C = 5 \text{ ma}, f = 1 \text{ kc}$								
h_{ob} Small-Signal Common-Base Output Admittance	$V_{CB} = 5 \text{ v}, I_C = 1 \text{ ma}, f = 1 \text{ kc}$							μmho	
	$V_{CB} = 10 \text{ v}, I_C = 5 \text{ ma}, f = 1 \text{ kc}$							μmho	
h_{fe} Small-Signal Common-Emitter Forward Current Transfer Ratio	$V_{CE} = 5 \text{ v}, I_C = 1 \text{ ma}, f = 1 \text{ kc}$								
	$V_{CE} = 10 \text{ v}, I_C = 5 \text{ ma}, f = 1 \text{ kc}$								
$ h_{fe} $ Small-Signal Common-Emitter Forward Current Transfer Ratio	$V_{CE} = 10 \text{ v}, I_C = 50 \text{ ma}, f = 20 \text{ mc}$	2.0		2.5		2.0	2.5		
C_{ob} Common-Base Open-Circuit Output Capacitance	$V_{CB} = 10 \text{ v}, I_E = 0, f = 1 \text{ mc}$	35		35		35	35	pf	
C_{ib} Common-Base Open-Circuit Input Capacitance	$V_{EB} = 0.5 \text{ v}, I_C = 0, f = 1 \text{ mc}$					80	80	pf	

NOTE 12: These parameters must be measured using pulse techniques. $PW \leq 300 \mu\text{sec}$, Duty Cycle $\leq 2\%$. Pulse width must be such that halving or doubling does not cause a change greater than the required accuracy of the measurement.

*Indicates JEDEC registered data

TYPES 2N696, 2N697, 2N717, 2N718, 2N718A, 2N730, 2N731, 2N956, 2N1420, 2N1507, 2N1613, 2N1711 N-P-N DOUBLE-DIFFUSED PLANAR SILICON TRANSISTORS

* electrical characteristics at 25°C free-air temperature (unless otherwise noted)

PARAMETER	TEST CONDITIONS	TO-18 →	2N718A			2N956	UNIT
		TO-5 →	2N1613	2N1420	2N1507	2N1711	
			MIN MAX	MIN MAX	MIN MAX	MIN MAX	
V_{CBO} Collector-Base Breakdown Voltage	$I_C = 100 \mu\text{a}, I_E = 0$		75	60	60	75	v
V_{CEO} Collector-Emitter Breakdown Voltage	$I_C = 30 \text{ ma}, I_B = 0$, See Note 12				25		v
V_{CER} Collector-Emitter Breakdown Voltage	$I_C = 100 \text{ ma}, R_{BE} = 10 \Omega$, See Note 12		50	30	30	50	v
V_{EBO} Emitter-Base Breakdown Voltage	$I_E = 100 \mu\text{a}, I_C = 0$		7			7	v
I_{CBO} Collector Cutoff Current	$V_{CB} = 30 \text{ v}, I_E = 0$			1.0	1.0		μa
	$V_{CB} = 30 \text{ v}, I_E = 0, T_A = 150^\circ\text{C}$			100	50		μa
	$V_{CB} = 60 \text{ v}, I_E = 0$		0.010			0.010	μa
	$V_{CB} = 60 \text{ v}, I_E = 0, T_A = 150^\circ\text{C}$		10			10	μa
I_{CER} Collector Cutoff Current	$V_{CE} = 20 \text{ v}, R_{BE} = 100 \text{ k}\Omega$				10		μa
I_{EBO} Emitter Cutoff Current	$V_{EB} = 5 \text{ v}, I_C = 0$		0.01		100	0.005	μa
h_{FE} Static Forward Current Transfer Ratio	$V_{CE} = 10 \text{ v}, I_C = 10 \mu\text{a}$					20	
	$V_{CE} = 10 \text{ v}, I_C = 100 \mu\text{a}$		20			35	
	$V_{CE} = 10 \text{ v}, I_C = 10 \text{ ma}$, See Note 12		35			75	
	$V_{CE} = 10 \text{ v}, I_C = 10 \text{ ma}, T_A = -55^\circ\text{C}$, See Note 12		20			35	
	$V_{CE} = 10 \text{ v}, I_C = 150 \text{ ma}$, See Note 12		40 120	100 300	100 300	100 300	
V_{BE} Base-Emitter Voltage	$I_B = 15 \text{ ma}, I_C = 150 \text{ ma}$, See Note 12		1.3	1.3	1.3	1.3	v
$V_{CE(sat)}$ Collector-Emitter Saturation Voltage	$I_B = 15 \text{ ma}, I_C = 150 \text{ ma}$, See Note 12		1.5	1.5	1.5	1.5	v
h_{ib} Small-Signal Common-Base Input Impedance	$V_{CB} = 5 \text{ v}, I_C = 1 \text{ ma}, f = 1 \text{ kc}$		24 34			24 34	ohm
	$V_{CB} = 10 \text{ v}, I_C = 5 \text{ ma}, f = 1 \text{ kc}$		4 8			4 8	ohm
h_{rb} Small-Signal Common-Base Reverse Voltage Transfer Ratio	$V_{CB} = 5 \text{ v}, I_C = 1 \text{ ma}, f = 1 \text{ kc}$		3×10^{-4}			5×10^{-4}	
	$V_{CB} = 10 \text{ v}, I_C = 5 \text{ ma}, f = 1 \text{ kc}$		3×10^{-4}			5×10^{-4}	
h_{ob} Small-Signal Common-Base Output Admittance	$V_{CB} = 5 \text{ v}, I_C = 1 \text{ ma}, f = 1 \text{ kc}$		0.1 0.5			0.1 0.5	μmho
	$V_{CB} = 10 \text{ v}, I_C = 5 \text{ ma}, f = 1 \text{ kc}$		0.1 1.0			0.1 1.0	μmho
h_{fe} Small-Signal Common-Emitter Forward Current Transfer Ratio	$V_{CE} = 5 \text{ v}, I_C = 1 \text{ ma}, f = 1 \text{ kc}$		30 100			50 200	
	$V_{CE} = 10 \text{ v}, I_C = 5 \text{ ma}, f = 1 \text{ kc}$		35 150			70 300	
$ h_{fo} $ Small-Signal Common-Emitter Forward Current Transfer Ratio	$V_{CE} = 10 \text{ v}, I_C = 50 \text{ ma}, f = 20 \text{ mc}$		3.0	2.5	2.5	3.5	
C_{ob} Common-Base Open-Circuit Output Capacitance	$V_{CB} = 10 \text{ v}, I_E = 0, f = 1 \text{ mc}$		25	35	35	25	pf
C_{ib} Common-Base Open-Circuit Input Capacitance	$V_{EB} = 0.5 \text{ v}, I_C = 0, f = 1 \text{ mc}$		80			80	pf

See operating and switching characteristics for types 2N718A, 2N956, 2N1613, and 2N1711 on page 4.

NOTE 12: These parameters must be measured using pulse techniques. $PW \leq 300 \mu\text{s}$, Duty Cycle $\leq 2\%$. Pulse width must be such that halving or doubling does not cause a change greater than the required accuracy of the measurement.

*Indicates JEDEC registered data

TYPES 2N696, 2N697, 2N717, 2N718, 2N718A, 2N730, 2N731, 2N956, 2N1420, 2N1507, 2N1613, 2N1711 N-P-N DOUBLE-DIFFUSED PLANAR SILICON TRANSISTORS

*operating characteristics at 25°C free-air temperature

PARAMETER	TEST CONDITIONS	2N956		2N718A		UNIT
		2N1711		2N1613		
		TYP	MAX	TYP	MAX	
NF Spot Noise Figure	$V_{CE} = 10 \text{ v}$, $I_C = 300 \mu\text{a}$ $R_E = 510 \Omega$, $f = 1 \text{ kc}$	5	8	6	12	db

* switching characteristics at 25°C free-air temperature

PARAMETER	TEST CONDITIONS	2N718A		UNIT
		2N1613		
		TYP	MAX	
t_T Total Switching Time	See Figure 1	20	30	nsec

*PARAMETER MEASUREMENT INFORMATION

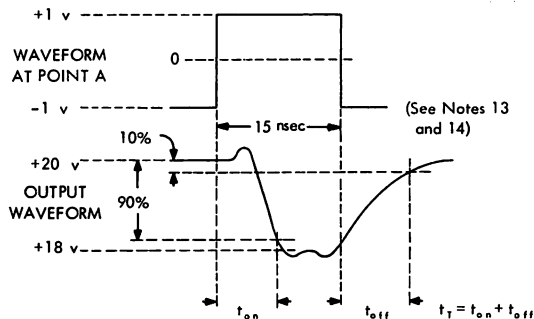
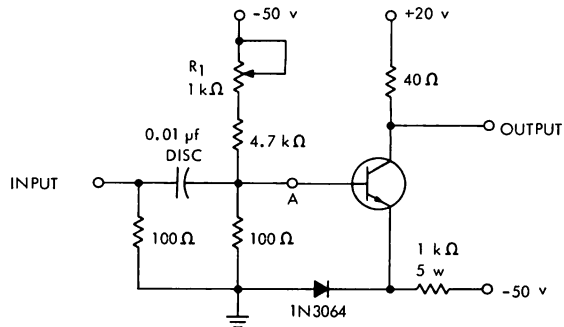

FIGURE 1 — SWITCHING TIME MEASUREMENT CIRCUIT FOR 2N718A AND 2N1613

NOTES: 13. The input waveform is supplied by a mercury relay pulse generator with the following characteristics: $t_r \leq 1 \text{ nsec}$, $t_f \leq 1 \text{ nsec}$, $PW = 15 \text{ nsec}$. Adjust R_1 and the input pulse amplitude to obtain the specified voltage levels at Point A.

14. Waveforms are monitored on a sampling oscilloscope ($t_r \leq 0.4 \text{ nsec}$) using a 2000 Ω probe.

*Indicates JEDEC registered data (typical data excluded)

TYPES 2N696, 2N697, 2N717, 2N718, 2N718A, 2N730, 2N731, 2N956, 2N1420, 2N1507, 2N1613, 2N1711 N-P-N DOUBLE-DIFFUSED PLANAR SILICON TRANSISTORS

TYPICAL CHARACTERISTICS

COLLECTOR-EMITTER SATURATION VOLTAGE
vs
COLLECTOR CURRENT

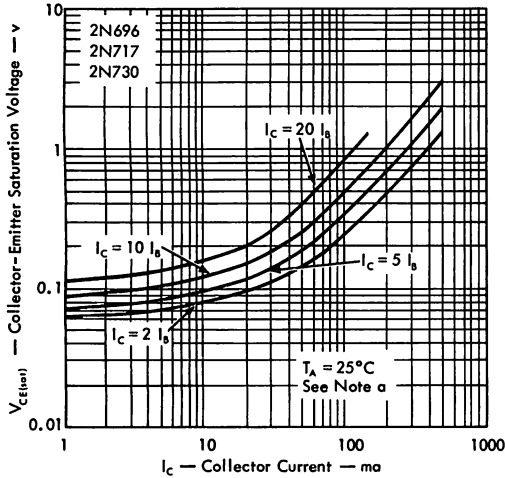

COLLECTOR-EMITTER SATURATION VOLTAGE
vs
COLLECTOR CURRENT

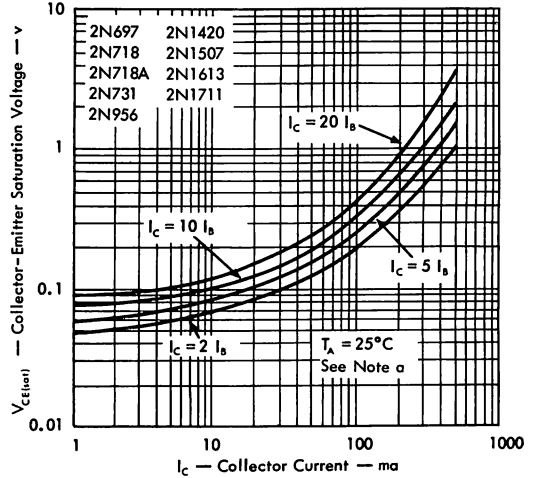

COLLECTOR-EMITTER SATURATION VOLTAGE
vs
FREE-AIR TEMPERATURE

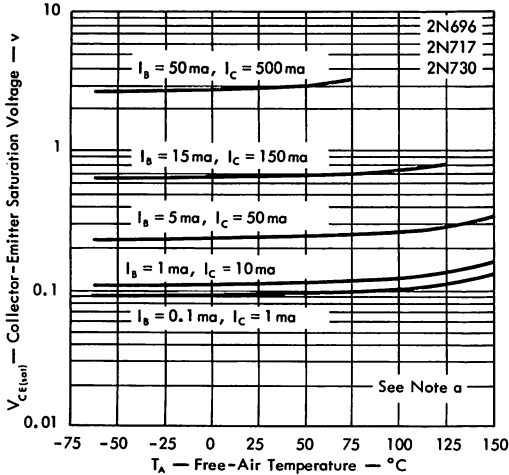

COLLECTOR-EMITTER SATURATION VOLTAGE
vs
FREE-AIR TEMPERATURE

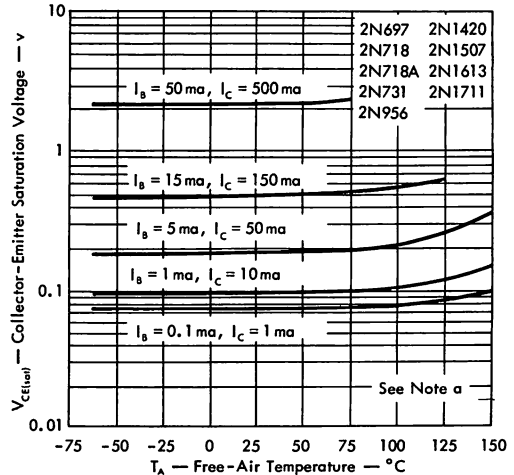

NOTE a: These parameters were measured using pulse techniques. PW = 300 μsec , Duty Cycle $\leq 2\%$.

TYPES 2N696, 2N697, 2N717, 2N718, 2N718A, 2N730, 2N731, 2N956, 2N1420, 2N1507, 2N1613, 2N1711

N-P-N DOUBLE-DIFFUSED PLANAR SILICON TRANSISTORS

TYPICAL CHARACTERISTICS

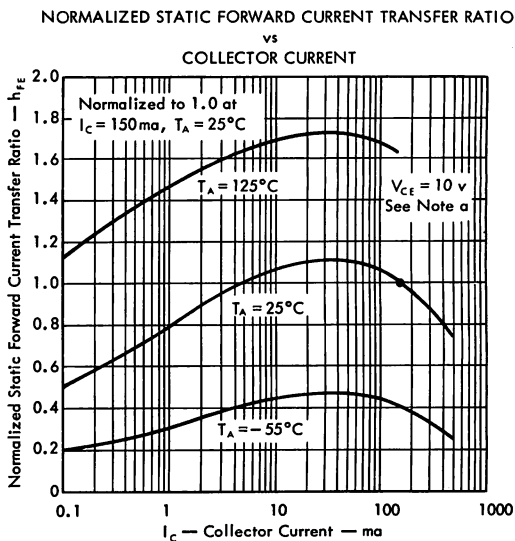
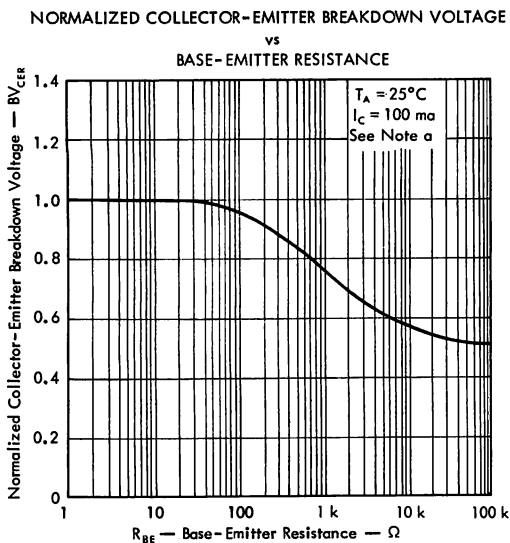
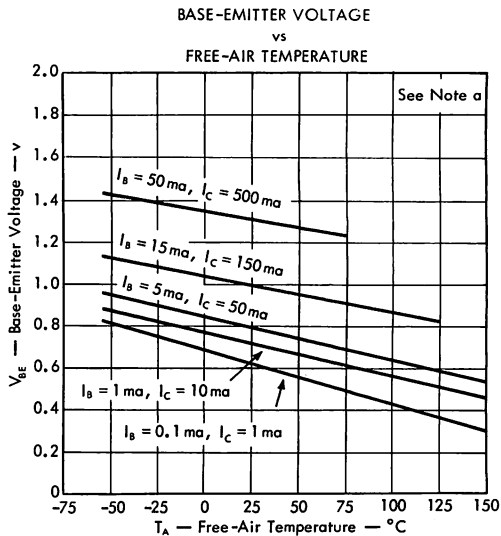
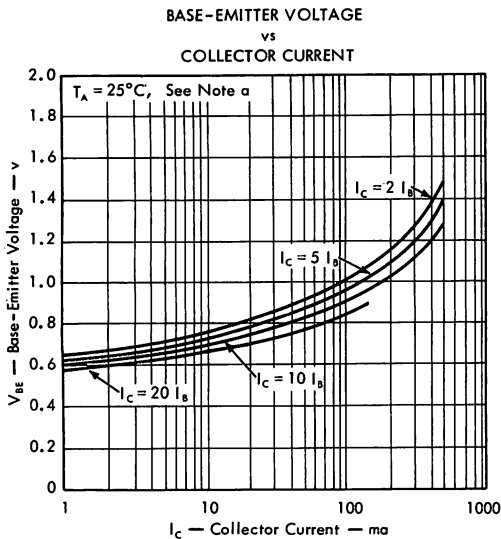

NOTE a: These parameters were measured using pulse techniques. PW = 300 μsec , Duty Cycle $\leq 2\%$.

TYPES 2N696, 2N697, 2N717, 2N718, 2N718A, 2N730, 2N731, 2N956, 2N1420, 2N1507, 2N1613, 2N1711 N-P-N DOUBLE-DIFFUSED PLANAR SILICON TRANSISTORS

TYPICAL CHARACTERISTICS

SMALL-SIGNAL COMMON-BASE INPUT IMPEDANCE
vs
COLLECTOR CURRENT

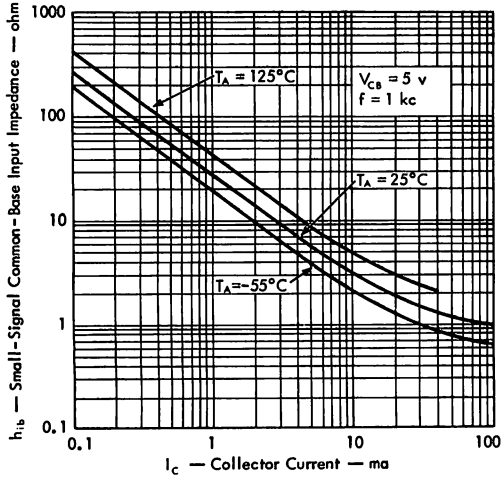

SMALL-SIGNAL COMMON-BASE OUTPUT ADMITTANCE
vs
COLLECTOR CURRENT

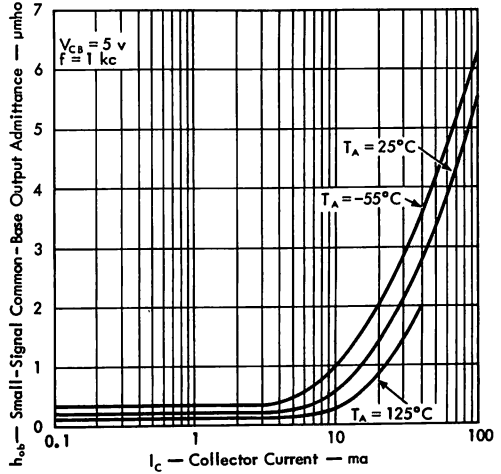

SMALL-SIGNAL COMMON-BASE
REVERSE VOLTAGE TRANSFER RATIO
vs
COLLECTOR CURRENT

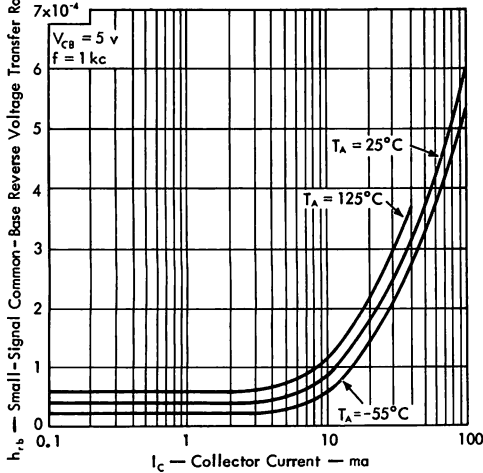

NORMALIZED SMALL-SIGNAL COMMON-EMITTER
FORWARD CURRENT TRANSFER RATIO
vs
COLLECTOR CURRENT

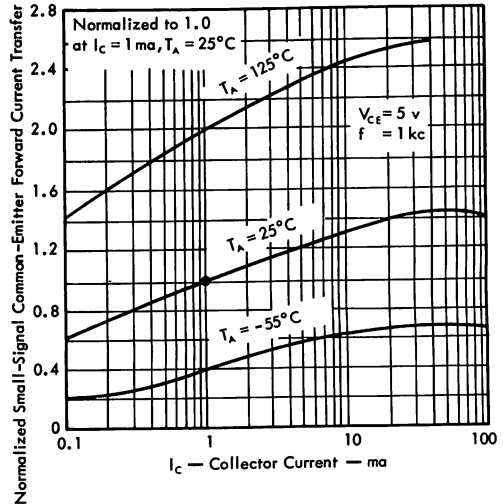

TYPES 2N696, 2N697, 2N717, 2N718, 2N718A, 2N730, 2N731, 2N956, 2N1420, 2N1507, 2N1613, 2N1711 N-P-N DOUBLE-DIFFUSED PLANAR SILICON TRANSISTORS

TYPICAL CHARACTERISTICS

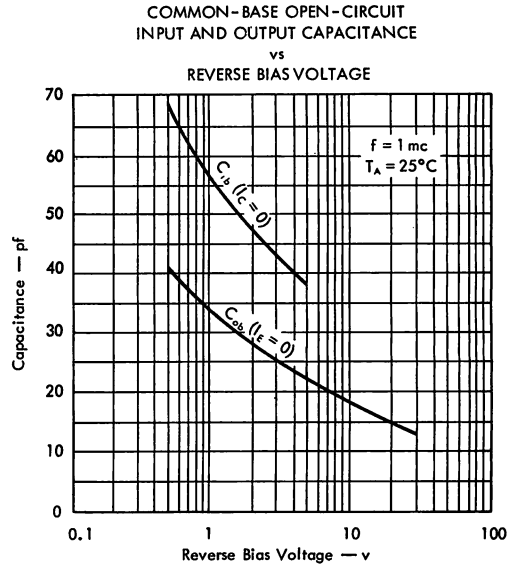
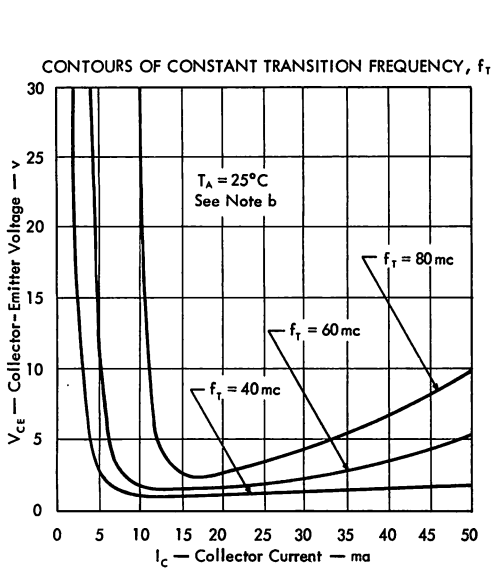

NOTE b: To obtain f_T , the $|h_{fe}|$ response with frequency is extrapolated at the rate of -6 db per octave from $f = 20\text{ mc}$ to the frequency at which $|h_{fe}| = 1$.

THERMAL CHARACTERISTICS

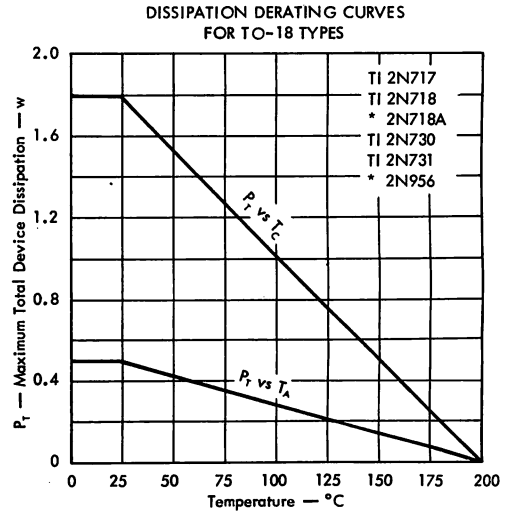
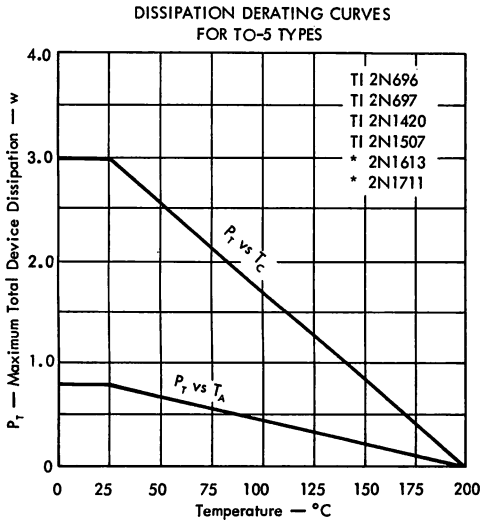

*Indicates JEDEC registered data

TYPES 2N698, 2N699, 2N719, 2N719A, 2N720 2N720A, 2N870, 2N871, 2N1889, 2N1890, 2N1893 N-P-N DOUBLE-DIFFUSED PLANAR SILICON TRANSISTORS



TYPES 2N698, 2N699, 2N719, 2N719A, 2N720
 2N720A, 2N870, 2N871, 2N1889, 2N1890, 2N1893
 BULLETIN NO. D1-S-683442, MAY 1963
 REVISED MAY 1968

Highly Reliable, Versatile Devices Designed for
 Amplifier, Switching and Oscillator Applications
 from <0.1 ma to >150 ma, dc to 30 mc

- High Voltage • Low Leakage
- Useful h_{FE} Over Wide Current Range

***mechanical data**

Device types 2N719, 2N719A, 2N720, 2N720A, 2N870 and 2N871 are in JEDEC TO-18 packages.

Device types 2N698, 2N699, 2N1889, 2N1890, and 2N1893 are in JEDEC TO-5 packages.

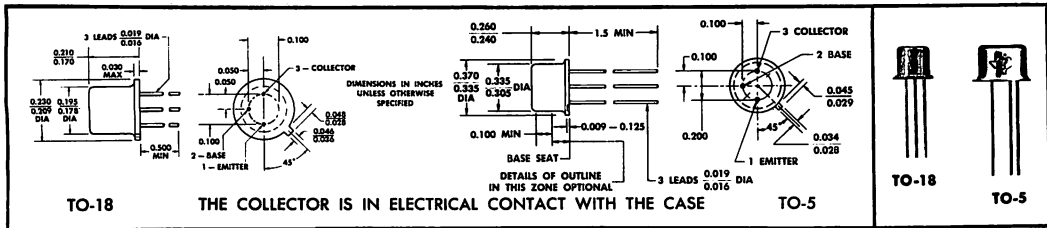

***absolute maximum ratings at 25°C free-air temperature (unless otherwise noted)**

	2N698	2N699	2N719 2N720	2N719A	2N720A	2N870 2N871	2N1889 2N1890	2N1893	UNIT
Collector-Base Voltage	120	120	120	120	120	100	100	120	v
Collector-Emitter Voltage (See Note 1)	80	80	80	80	100	80	80	100	v
Collector-Emitter Voltage (See Note 2)	60			60	80	60	60	80	v
Emitter-Base Voltage	7	5	5	7	7	7	7	7	v
Collector Current				1.0				0.5	a
Total Device Dissipation at (or below) 25°C Free-Air Temperature (See Note Indicated in Parentheses) →	0.8 (3)	0.6 † (5)	0.4 †† (7)	0.5 (9)	0.5 (9)	0.5 (9)	0.8 (3)	0.8 (3)	w
Total Device Dissipation at (or below) 25°C Case Temperature (See Note Indicated in Parentheses) →	3.0 (4)	2.0 † (6)	1.5 †† (8)	1.8 (10)	1.8 (10)	1.8 (10)	3.0 (4)	3.0 (4)	w
Total Device Dissipation at 100°C Case Temperature	1.7	1.0 †	0.75 ††	1.0	1.0	1.0	1.7	1.7	w
Operating Collector Junction Temperature	200	175†	175††	200	200	200	200	200	°C
Storage Temperature Range	-65°C to 200°C								

- NOTES: 1. This values applies when the base-emitter resistance (R_{BE}) is equal to or less than 10 ohms.
 2. This values applies when the base-emitter diode is open-circuited.
 3. Derate linearly to 200°C free-air temperature at the rate of 4.56 mw/°C.
 4. Derate linearly to 200°C case temperature at the rate of 17.2 mw/°C.
 5. Derate linearly to 175°C free-air temperature at the rate of 4.0 mw/°C.
 6. Derate linearly to 175°C case temperature at the rate of 13.3 mw/°C.
 7. Derate linearly to 175°C free-air temperature at the rate of 2.67 mw/°C.
 8. Derate linearly to 175°C case temperature at the rate of 10.0 mw/°C.
 9. Derate linearly to 200°C free-air temperature at the rate of 2.86 mw/°C.
 10. Derate linearly to 200°C case temperature at the rate of 10.3 mw/°C.

†Texas Instruments guarantees its type 2N699 to be capable of the same dissipation as registered and shown for types 2N698, 2N1889, 2N1890, and 2N1893 with appropriate derating factors shown in Notes 3 and 4. See derating curves, page 6.

††Texas Instruments guarantees its types 2N719 and 2N720 to be capable of the same dissipation as registered and shown for types 2N719A, 2N720A, 2N870, and 2N871 with appropriate derating factors shown in Notes 9 and 10. See derating curves, page 6.

*Indicates JEDEC registered data.



TYPES 2N698, 2N699, 2N719, 2N719A, 2N720 2N720A, 2N870, 2N871, 2N1889, 2N1890, 2N1893 N-P-N DOUBLE-DIFFUSED PLANAR SILICON TRANSISTORS

*electrical characteristics at 25°C free-air temperature (unless otherwise noted)

PARAMETER	TEST CONDITIONS	TO-18	2N698		2N699		2N719		2N719A		UNIT
		TO-5	MIN	MAX	MIN	MAX	MIN	MAX	MIN	MAX	
		$I_C = 100 \mu\text{a}, I_E = 0$	120				120	120			
$I_C = 30 \text{ ma}, I_B = 0$, See Note 11	60					60				v	
$I_C = 100 \text{ ma}, R_{BE} = 10 \Omega$, See Note 11	80			80		80				v	
$I_E = 100 \mu\text{a}, I_C = 0$	7							7		v	
$I_E = 1 \text{ ma}, I_C = 0$						5				v	
I_{CBO} Collector Cutoff Current	$V_{CB} = 60 \text{ v}, I_E = 0$				2		2			μa	
	$V_{CB} = 60 \text{ v}, I_E = 0, T_A = 150^\circ\text{C}$					200				μa	
	$V_{CB} = 75 \text{ v}, I_E = 0$		0.005					0.010		μa	
	$V_{CB} = 75 \text{ v}, I_E = 0, T_A = 150^\circ\text{C}$		15					15		μa	
	$V_{CB} = 90 \text{ v}, I_E = 0$									μa	
	$V_{CB} = 90 \text{ v}, I_E = 0, T_A = 150^\circ\text{C}$									μa	
I_{EBO} Emitter Cutoff Current	$V_{EB} = 2 \text{ v}, I_C = 0$					100				μa	
	$V_{EB} = 5 \text{ v}, I_C = 0$		0.010					0.010		μa	
h_{FE} Static Forward Current Transfer Ratio	$V_{CE} = 10 \text{ v}, I_C = 100 \mu\text{a}$										
	$V_{CE} = 10 \text{ v}, I_C = 10 \text{ ma}$, See Note 11										
	$V_{CE} = 10 \text{ v}, I_C = 10 \text{ ma}, T_A = -55^\circ\text{C}$, See Note 11										
	$V_{CE} = 10 \text{ v}, I_C = 150 \text{ ma}$, See Note 11	20	60	40	120	20	60	20	60		
V_{BE} Base-Emitter Voltage	$I_B = 5 \text{ ma}, I_C = 50 \text{ ma}$, See Note 11		0.9						0.9	v	
	$I_B = 15 \text{ ma}, I_C = 150 \text{ ma}$, See Note 11		1.3		1.3		1.3		1.3	v	
$V_{CE(sat)}$ Collector-Emitter Saturation Voltage	$I_B = 5 \text{ ma}, I_C = 50 \text{ ma}$, See Note 11		1.2					1.2		v	
	$I_B = 15 \text{ ma}, I_C = 150 \text{ ma}$, See Note 11		5		5		5		5	v	
h_{ib} Small-Signal Common-Base Input Impedance	$V_{CB} = 5 \text{ v}, I_C = 1 \text{ ma}, f = 1 \text{ kc}$	20	35	20	30	20	35	20	35	ohm	
	$V_{CB} = 10 \text{ v}, I_C = 5 \text{ ma}, f = 1 \text{ kc}$		10		10		10		10	ohm	
h_{rb} Small-Signal Common-Base Reverse Voltage Transfer Ratio	$V_{CB} = 5 \text{ v}, I_C = 1 \text{ ma}, f = 1 \text{ kc}$		2.5×10^{-4}		2.5×10^{-4}		2.5×10^{-4}		2.5×10^{-4}		
	$V_{CB} = 10 \text{ v}, I_C = 5 \text{ ma}, f = 1 \text{ kc}$		5×10^{-4}		3×10^{-4}		5×10^{-4}		5×10^{-4}		
h_{ob} Small-Signal Common-Base Output Admittance	$V_{CB} = 5 \text{ v}, I_C = 1 \text{ ma}, f = 1 \text{ kc}$	0.5		0.1	0.5	0.1	0.5	0.1	0.5	μmho	
	$V_{CB} = 10 \text{ v}, I_C = 5 \text{ ma}, f = 1 \text{ kc}$		1.0		1.0		1.0		1.0	μmho	
h_{fe} Small-Signal Common-Emitter Forward Current Transfer Ratio	$V_{CE} = 5 \text{ v}, I_C = 1 \text{ ma}, f = 1 \text{ kc}$	15		35	100	15		15			
	$V_{CE} = 10 \text{ v}, I_C = 5 \text{ ma}, f = 1 \text{ kc}$	25		45		25		25			
$ h_{fe} $ Small-Signal Common-Emitter Forward Current Transfer Ratio	$V_{CE} = 10 \text{ v}, I_C = 50 \text{ ma}, f = 20 \text{ mc}$	2.0		2.5		2.0		2.0			
C_{ob} Common-Base Open-Circuit Output Capacitance	$V_{CB} = 10 \text{ v}, I_E = 0$, Except 2N719: $f = 140 \text{ kc}$	15		20		20		15		pf	
C_{ib} Common-Base Open-Circuit Input Capacitance	$V_{EB} = 0.5 \text{ v}, I_C = 0$, Except 2N719: $f = 140 \text{ kc}$	85				85		85		pf	

NOTE 11: These parameters must be measured using pulse techniques. $PW \leq 300 \mu\text{sec}$, Duty cycle $\leq 2\%$. Pulse width must be such that halving or doubling does not cause a change greater than the required accuracy of the measurement.

*Indicates JEDEC registered data.

TYPES 2N698, 2N699, 2N719, 2N719A, 2N720 2N720A, 2N870, 2N871, 2N1889, 2N1890, 2N1893 N-P-N DOUBLE-DIFFUSED PLANAR SILICON TRANSISTORS

*electrical characteristics at 25°C free-air temperature (unless otherwise noted)

PARAMETER	TEST CONDITIONS	TO-18		2N720		2N720A		2N870		2N871		UNIT
		TO-5				2N1893		2N1889		2N1890		
		MIN	MAX	MIN	MAX	MIN	MAX	MIN	MAX	MIN	MAX	
V_{CB0} Collector-Base Breakdown Voltage	$I_C = 100 \mu\text{a}$, $I_E = 0$	120		120		100		100				v
V_{CEO} Collector-Emitter Breakdown Voltage	$I_C = 30 \text{ ma}$, $I_B = 0$, See Note 11			80		60		60				v
V_{CER} Collector-Emitter Breakdown Voltage	$I_C = 100 \text{ ma}$, $R_{BE} = 10 \Omega$, See Note 11	80		100		80		80				v
V_{EBO} Emitter-Base Breakdown Voltage	$I_E = 100 \mu\text{a}$, $I_C = 0$			7		7		7				v
	$I_E = 1 \text{ ma}$, $I_C = 0$	5										v
I_{CBO} Collector Cutoff Current	$V_{CB} = 60 \text{ v}$, $I_E = 0$		2									μa
	$V_{CB} = 60 \text{ v}$, $I_E = 0$, $T_A = 150^\circ\text{C}$		200									μa
	$V_{CB} = 75 \text{ v}$, $I_E = 0$					0.010		0.010				μa
	$V_{CB} = 75 \text{ v}$, $I_E = 0$, $T_A = 150^\circ\text{C}$					15		15				μa
	$V_{CB} = 90 \text{ v}$, $I_E = 0$					0.010		0.010				μa
	$V_{CB} = 90 \text{ v}$, $I_E = 0$, $T_A = 150^\circ\text{C}$					15		15				μa
I_{EBO} Emitter Cutoff Current	$V_{EB} = 2 \text{ v}$, $I_C = 0$											μa
	$V_{EB} = 5 \text{ v}$, $I_C = 0$			0.010		0.010		0.010		0.010		μa
h_{FE} Static Forward Current Transfer Ratio	$V_{CE} = 10 \text{ v}$, $I_C = 100 \mu\text{a}$			20		20						
	$V_{CE} = 10 \text{ v}$, $I_C = 10 \text{ ma}$, See Note 11			35		35						
	$V_{CE} = 10 \text{ v}$, $I_C = 10 \text{ ma}$, $T_A = -55^\circ\text{C}$, See Note 11			20		20						
	$V_{CE} = 10 \text{ v}$, $I_C = 150 \text{ ma}$, See Note 11	40	120	40	120	40	120	100	300			
V_{BE} Base-Emitter Voltage	$I_B = 5 \text{ ma}$, $I_C = 50 \text{ ma}$, See Note 11					0.9		0.9		0.9		v
	$I_B = 15 \text{ ma}$, $I_C = 150 \text{ ma}$, See Note 11			1.3		1.3		1.3		1.3		v
$V_{CE(sat)}$ Collector-Emitter Saturation Voltage	$I_B = 5 \text{ ma}$, $I_C = 50 \text{ ma}$, See Note 11					1.2		1.2		1.2		v
	$I_B = 15 \text{ ma}$, $I_C = 150 \text{ ma}$, See Note 11			5		5		5		5		v
h_{ib} Small-Signal Common-Base Input Impedance	$V_{CB} = 5 \text{ v}$, $I_C = 1 \text{ ma}$, $f = 1 \text{ kc}$	20	30	20	30	20	30	20	30	20	30	ohm
	$V_{CB} = 10 \text{ v}$, $I_C = 5 \text{ ma}$, $f = 1 \text{ kc}$	10		4	8	4	8	4	8	4	8	ohm
h_{rb} Small-Signal Common-Base Reverse Voltage Transfer Ratio	$V_{CB} = 5 \text{ v}$, $I_C = 1 \text{ ma}$, $f = 1 \text{ kc}$	2.5×10^{-4}		1.25×10^{-4}		1.25×10^{-4}		1.25×10^{-4}		1.5×10^{-4}		
	$V_{CB} = 10 \text{ v}$, $I_C = 5 \text{ ma}$, $f = 1 \text{ kc}$	3×10^{-4}		1.5×10^{-4}		1.5×10^{-4}		1.5×10^{-4}		1.5×10^{-4}		
h_{ob} Small-Signal Common-Base Output Admittance	$V_{CB} = 5 \text{ v}$, $I_C = 1 \text{ ma}$, $f = 1 \text{ kc}$	0.1	0.5			0.5		0.5		0.3		μmho
	$V_{CB} = 10 \text{ v}$, $I_C = 5 \text{ ma}$, $f = 1 \text{ kc}$		1.0			0.5		0.5		0.3		μmho
h_{fe} Small-Signal Common-Emitter Forward Current Transfer Ratio	$V_{CE} = 5 \text{ v}$, $I_C = 1 \text{ ma}$, $f = 1 \text{ kc}$	35	100	30	100	30	100	30	100	50	200	
	$V_{CE} = 10 \text{ v}$, $I_C = 5 \text{ ma}$, $f = 1 \text{ kc}$	45		45		45	150	70	300			
$ h_{fe} $ Small-Signal Common-Emitter Forward Current Transfer Ratio	$V_{CE} = 10 \text{ v}$, $I_C = 50 \text{ ma}$, $f = 20 \text{ mc}$	2.5		2.5		2.5		3.0				
C_{ob} Common-Base Open-Circuit Output Capacitance	$V_{CB} = 10 \text{ v}$, $I_E = 0$, $f = 1 \text{ mc}$ Except 2N720: $f = 140 \text{ kc}$		20		15		15		15		15	pf
C_{ib} Common-Base Open-Circuit Input Capacitance	$V_{EB} = 0.5 \text{ v}$, $I_C = 0$, $f = 1 \text{ mc}$ Except 2N720: $f = 140 \text{ kc}$		85		85		85		85		85	pf

NOTE 11: These parameters must be measured using pulse techniques. $PW \leq 300 \mu\text{sec.}$, Duty cycle $\leq 2\%$. Pulse width must be such that halving or doubling does not cause a change greater than the required accuracy of the measurement.

*Indicates JEDEC registered data.

TYPES 2N698, 2N699, 2N719, 2N719A, 2N720 2N720A, 2N870, 2N871, 2N1889, 2N1890, 2N1893 N-P-N DOUBLE-DIFFUSED PLANAR SILICON TRANSISTORS

TYPICAL CHARACTERISTICS

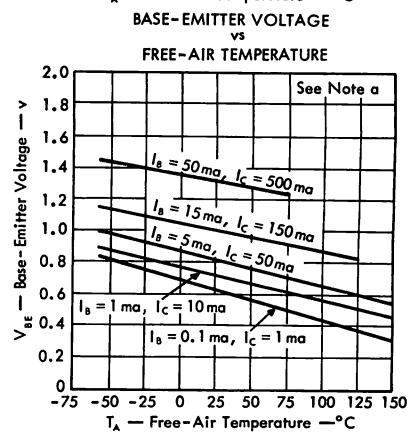
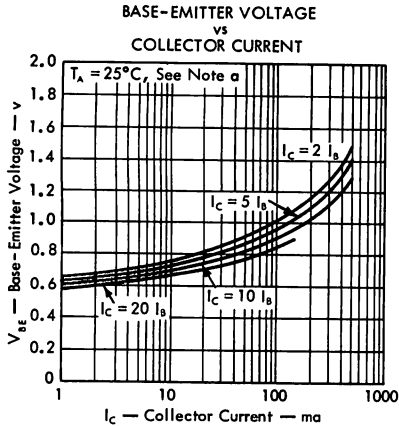
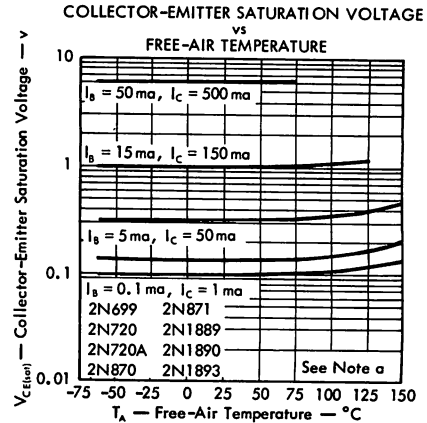
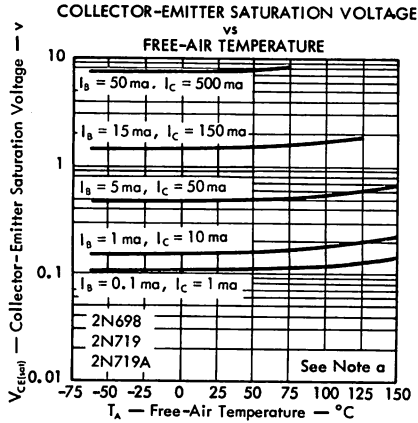
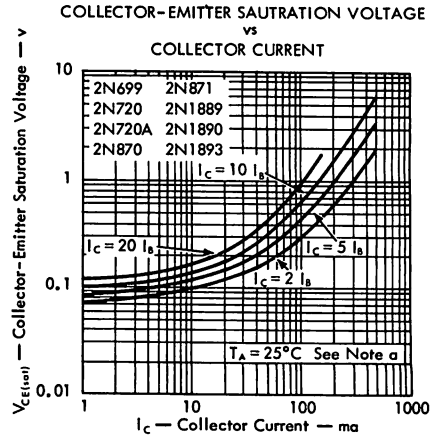
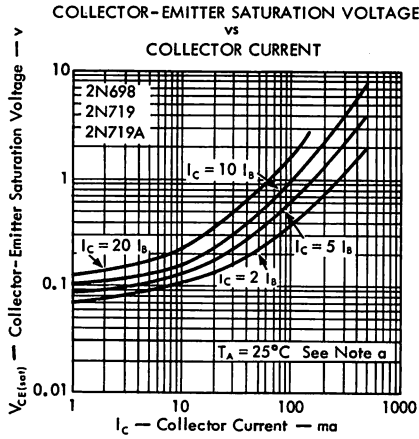

NOTE a: These parameters were measured using pulse techniques. PW = 300 μ sec, Duty Cycle 2%.

TYPES 2N698, 2N699, 2N719, 2N719A, 2N720 2N720A, 2N870, 2N871, 2N1889, 2N1890, 2N1893 N-P-N DOUBLE-DIFFUSED PLANAR SILICON TRANSISTORS

TYPICAL CHARACTERISTICS

NORMALIZED COLLECTOR-EMITTER BREAKDOWN VOLTAGE

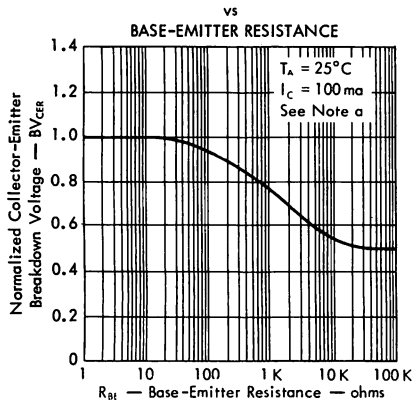

NORMALIZED STATIC FORWARD CURRENT TRANSFER RATIO

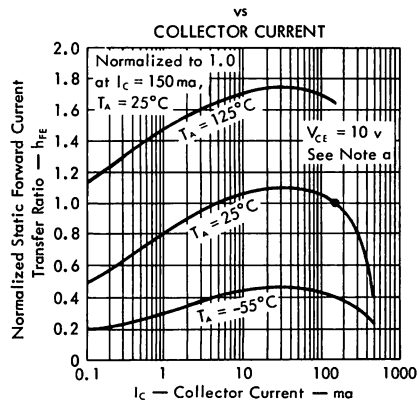

SMALL-SIGNAL COMMON-BASE INPUT IMPEDANCE

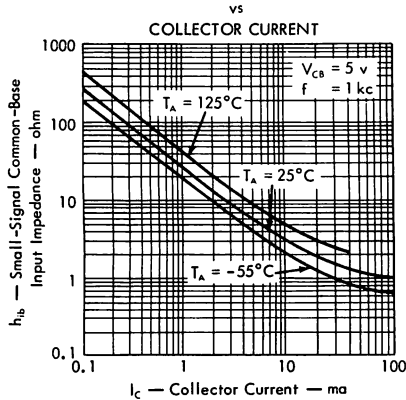

SMALL-SIGNAL COMMON-BASE OUTPUT ADMITTANCE

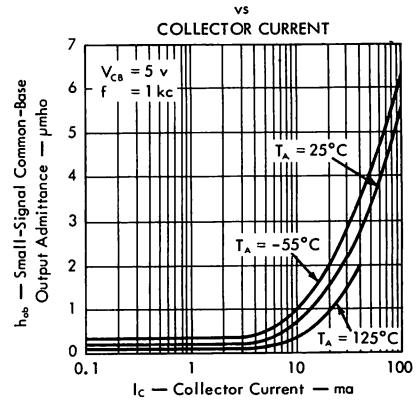

SMALL-SIGNAL COMMON-BASE REVERSE VOLTAGE TRANSFER RATIO

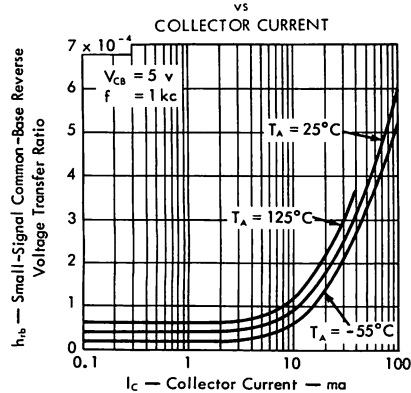

NORMALIZED SMALL-SIGNAL COMMON-EMITTER FORWARD CURRENT TRANSFER RATIO

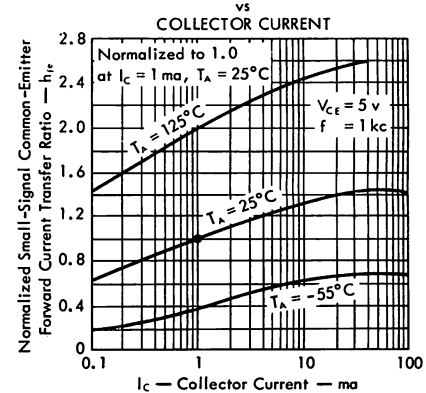

NOTE a: These parameters were measured using pulse techniques. PW = 300 μ sec, Duty Cycle \leq 2%.

TYPES 2N698, 2N699, 2N719, 2N719A, 2N720 2N720A, 2N870, 2N871, 2N1889, 2N1890, 2N1893 N-P-N DOUBLE-DIFFUSED PLANAR SILICON TRANSISTORS

TYPICAL CHARACTERISTICS

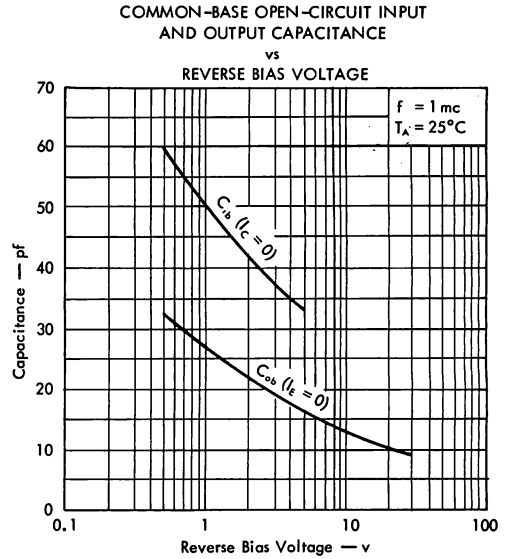
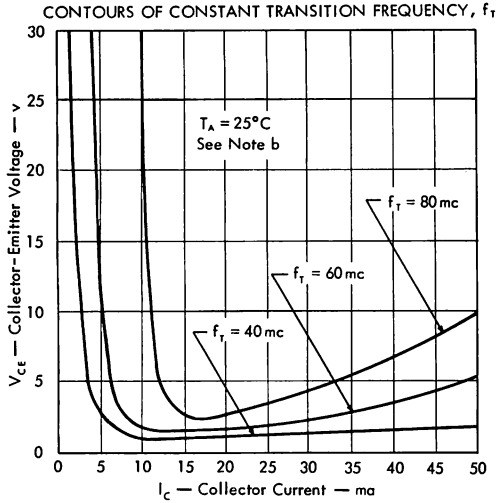

NOTE b: To obtain f_T , the h_{fe} response with frequency is extrapolated at the rate of -6 db per octave from $f = 20$ mc to the frequency at which $|h_{fe}| = 1$.

THERMAL CHARACTERISTICS

DISSIPATION DERATING CURVES
FOR TO-5 TYPES

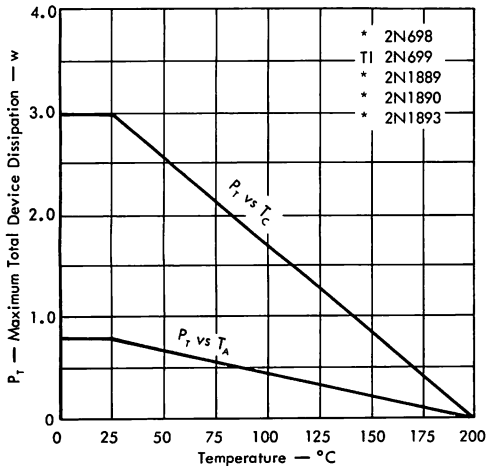

*Indicates JEDEC registered data.

DISSIPATION DERATING CURVES
FOR TO-18 TYPES

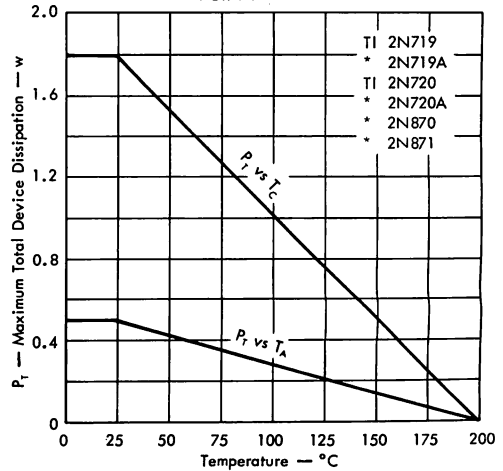

TYPES 2N929, 2N930 N-P-N PLANAR SILICON TRANSISTORS



TYPES 2N929, 2N930
BULLETIN NO. DL-5-633533
REVISED SEPTEMBER 1965
MAY 1963

FOR EXTREMELY LOW-LEVEL, LOW-NOISE, HIGH-GAIN,
SMALL-SIGNAL AMPLIFIER APPLICATIONS

- Guaranteed h_{FE} at 10 μ a, $T_A = -55^\circ\text{C}$ and 25°C
- Guaranteed Low-Noise Characteristics at 10 μ a
- Usable at Collector Currents as Low as 1 μ a
- Very High Reliability
- 2N929 and 2N930 Also Are Available to MIL-S-19500/253 (Sig C)

***mechanical data**

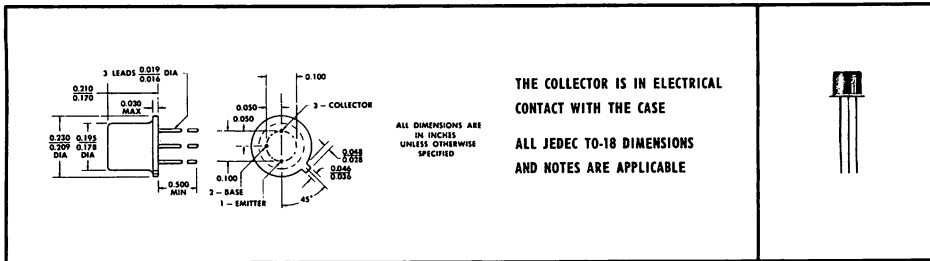

THE COLLECTOR IS IN ELECTRICAL CONTACT WITH THE CASE
ALL JEDEC TO-18 DIMENSIONS AND NOTES ARE APPLICABLE

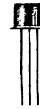

***absolute maximum ratings at 25°C free-air temperature (unless otherwise noted)**

Collector-Base Voltage	45 v
Collector-Emitter Voltage (See Note 1)	45 v
Emitter-Base Voltage	5 v
Collector Current	30 ma
Total Device Dissipation at (or below) 25°C Free-Air Temperature (See Note 2)	300 mw
Total Device Dissipation at (or below) 25°C Case Temperature (See Note 3)	600 mw
Operating Collector Junction Temperature	175°C
Storage Temperature Range	-65°C to +200°C

NOTES: 1. This value applies when the base-emitter diode is open-circuited.
2. Derate linearly to 175°C free-air temperature at the rate of 2.0 mw/°C.
3. Derate linearly to 175°C case temperature at the rate of 4.0 mw/°C.

*Indicates JEDEC registered data



TYPES 2N929, 2N930

N-P-N PLANAR SILICON TRANSISTOR

*electrical characteristics at 25°C free-air temperature (unless otherwise noted)

PARAMETER	TEST CONDITIONS	2N929		2N930		UNIT
		MIN	MAX	MIN	MAX	
BV_{CEO} Collector-Emitter Breakdown Voltage	$I_C = 10 \text{ ma}$, $I_B = 0$, (See Note 4)	45		45		v
BV_{EBO} Emitter-Base Breakdown Voltage	$I_E = 10 \text{ ma}$, $I_C = 0$	5		5		v
I_{CBO} Collector Cutoff Current	$V_{CB} = 45 \text{ v}$, $I_E = 0$		10		10	na
I_{CES} Collector Cutoff Current (See Note 5)	$V_{CE} = 45 \text{ v}$, $V_{BE} = 0$		10		10	na
	$V_{CE} = 45 \text{ v}$, $V_{BE} = 0$, $T_A = 170^\circ\text{C}$		10		10	μa
I_{CEO} Collector Cutoff Current	$V_{CE} = 5 \text{ v}$, $I_B = 0$		2		2	na
I_{EBO} Emitter Cutoff Current	$V_{EB} = 5 \text{ v}$, $I_C = 0$		10		10	na
h_{FE} Static Forward Current Transfer Ratio	$V_{CE} = 5 \text{ v}$, $I_C = 10 \mu\text{a}$	40	120	100	300	
	$V_{CE} = 5 \text{ v}$, $I_C = 10 \mu\text{a}$, $T_A = -55^\circ\text{C}$	10		20		
	$V_{CE} = 5 \text{ v}$, $I_C = 500 \mu\text{a}$	60		150		
	$V_{CE} = 5 \text{ v}$, $I_C = 10 \text{ ma}$, (See Note 4)		350		600	
V_{BE} Base-Emitter Voltage	$I_B = 0.5 \text{ ma}$, $I_C = 10 \text{ ma}$, (See Note 4)	0.6	1.0	0.6	1.0	v
$V_{CE(sat)}$ Collector-Emitter Saturation Voltage	$I_B = 0.5 \text{ ma}$, $I_C = 10 \text{ ma}$, (See Note 4)		1.0		1.0	v
h_{ib} Small-Signal Common-Base Input Impedance	$V_{CB} = 5 \text{ v}$, $I_E = -1 \text{ ma}$, $f = 1 \text{ kc}$	25	32	25	32	ohm
h_{rb} Small-Signal Common-Base Reverse Voltage Transfer Ratio	$V_{CB} = 5 \text{ v}$, $I_E = -1 \text{ ma}$, $f = 1 \text{ kc}$	0	6.0×10^{-4}	0	6.0×10^{-4}	
h_{ob} Small-Signal Common-Base Output Admittance	$V_{CB} = 5 \text{ v}$, $I_E = -1 \text{ ma}$, $f = 1 \text{ kc}$	0	1.0	0	1.0	μmho
h_{fe} Small-Signal Common-Emitter Forward Current Transfer Ratio	$V_{CE} = 5 \text{ v}$, $I_C = 1 \text{ ma}$, $f = 1 \text{ kc}$	60	350	150	600	
$ h_{re} $ Small-Signal Common-Emitter Reverse Current Transfer Ratio	$V_{CE} = 5 \text{ v}$, $I_C = 500 \mu\text{a}$, $f = 30 \text{ mc}$	1.0		1.0		
C_{ob} Common-Base Open-Circuit Output Capacitance	$V_{CB} = 5 \text{ v}$, $I_E = 0$, $f = 1 \text{ mc}$		8		8	pf

*operating characteristics at 25°C free-air temperature

PARAMETER	TEST CONDITIONS	2N929	2N930	UNIT
		MAX	MAX	
NF Average Noise Figure	$V_{CE} = 5 \text{ v}$, $I_C = 10 \mu\text{a}$, $R_G = 10 \text{ k}\Omega$ Noise Bandwidth 10 cps to 15.7 kc	4	3	db

NOTES: 4. These parameters must be measured using pulse techniques. PW = 300 μsec , Duty Cycle $\leq 2\%$.

5. I_{CES} may be used in place of I_{CBO} for circuit stability calculations.

• Indicates JEDEC registered data

TYPES 2N929, 2N930 N-P-N PLANAR SILICON TRANSISTORS

TYPICAL CHARACTERISTICS

2N929

SMALL-SIGNAL COMMON-EMITTER FORWARD CURRENT TRANSFER RATIO
vs
COLLECTOR CURRENT

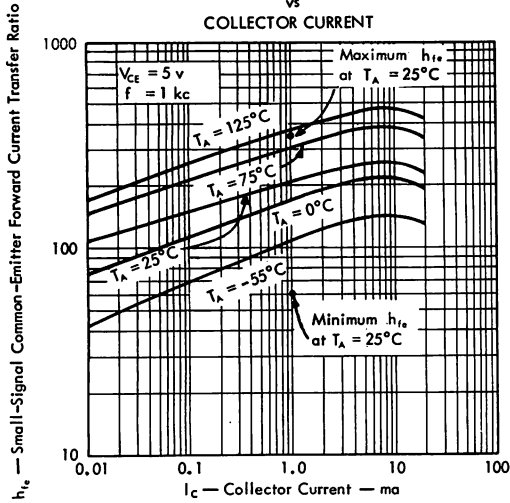

2N930

SMALL-SIGNAL COMMON-EMITTER FORWARD CURRENT TRANSFER RATIO
vs
COLLECTOR CURRENT

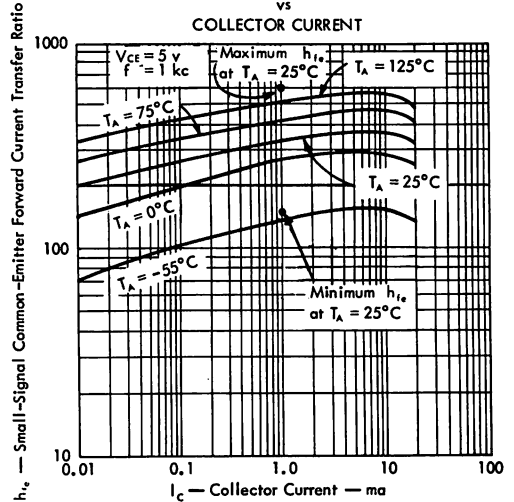

2N929 2N930

SMALL-SIGNAL COMMON-BASE INPUT IMPEDANCE
vs
EMITTER CURRENT

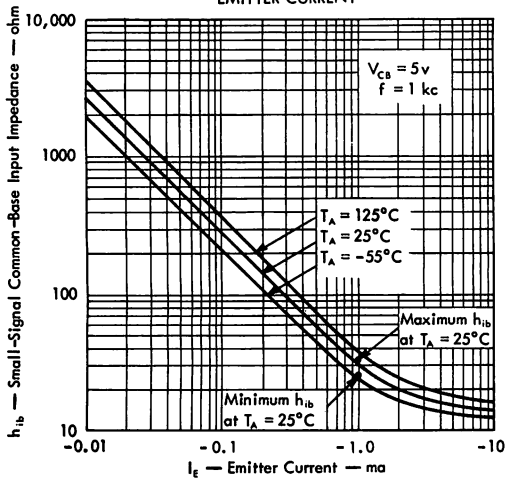

2N929 2N930

SMALL-SIGNAL COMMON-BASE OUTPUT ADMITTANCE
vs
EMITTER CURRENT

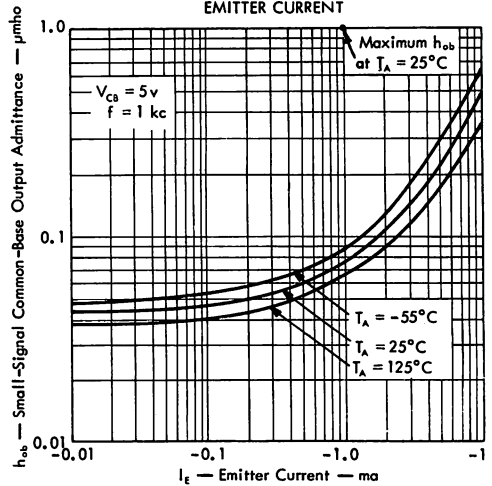

TYPES 2N929, 2N930

N-P-N PLANAR SILICON TRANSISTORS

TYPICAL CHARACTERISTICS

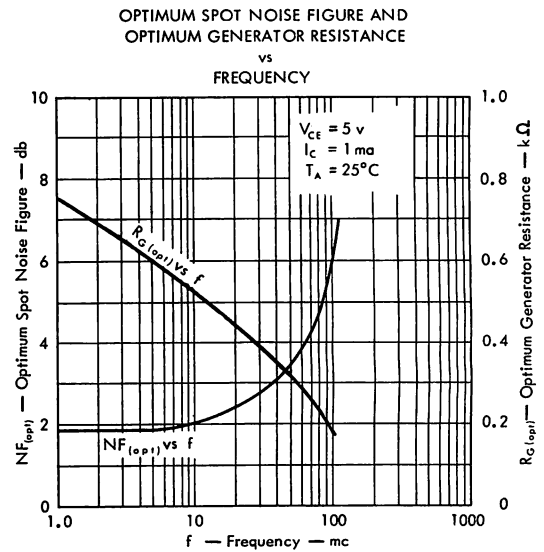
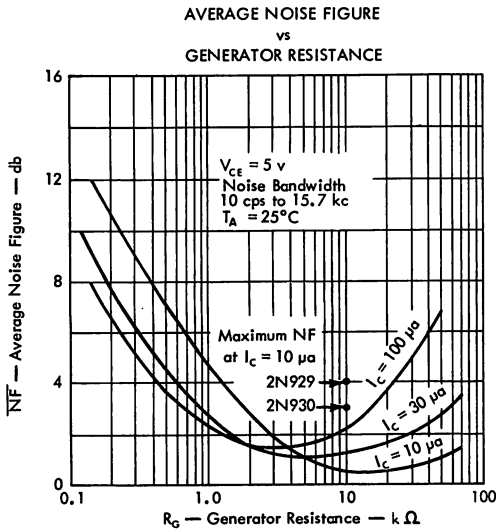
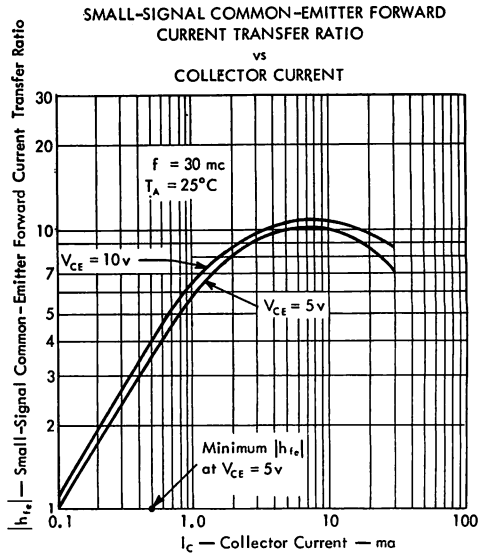
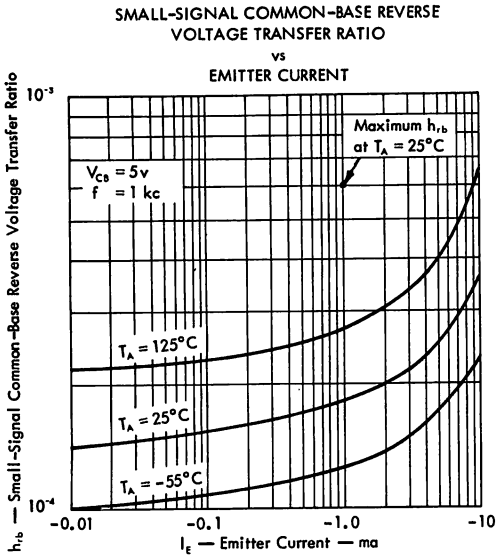

TYPES 2N929, 2N930 N-P-N PLANAR SILICON TRANSISTORS

TYPICAL CHARACTERISTICS

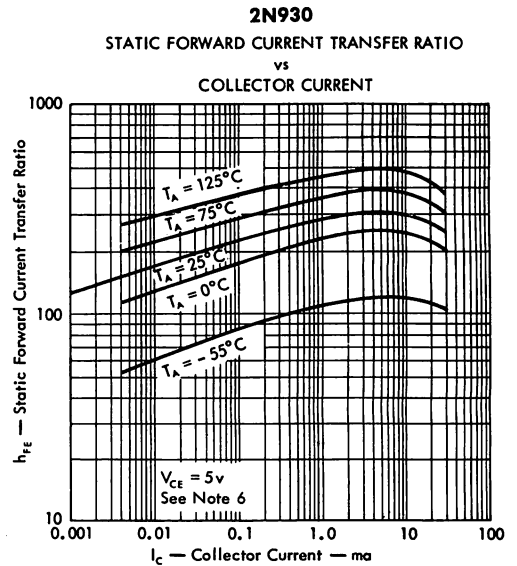
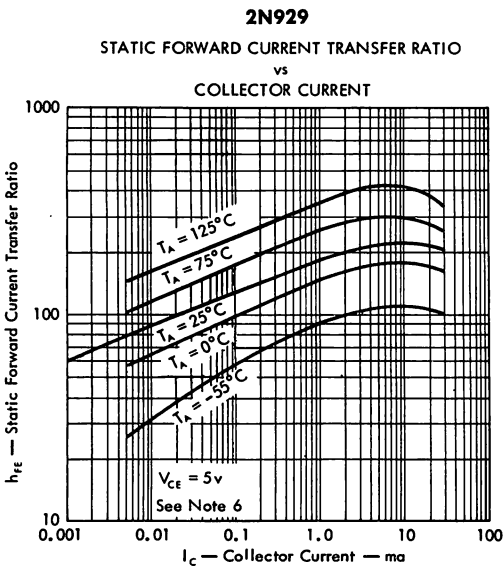
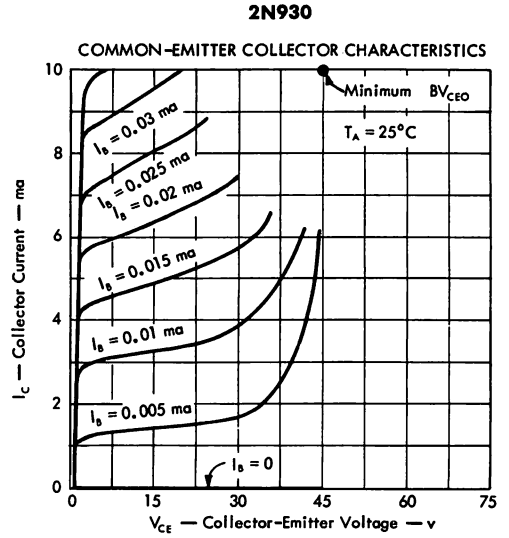
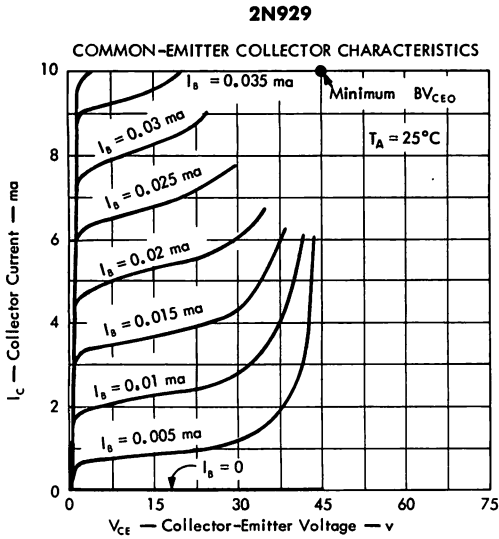

NOTE 6: These parameters were measured using pulse techniques. $PW = 300\ \mu\text{sec}$, Duty Cycle $\leq 2\%$.

TYPES 2N929, 2N930 N-P-N PLANAR SILICON TRANSISTORS

TYPICAL CHARACTERISTICS

2N929

BASE-EMITTER VOLTAGE
vs
FREE-AIR TEMPERATURE

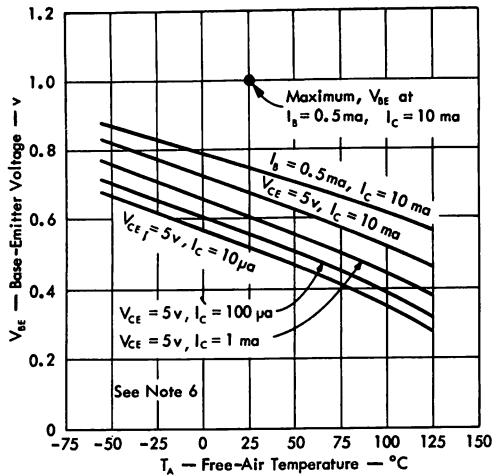

2N930

BASE-EMITTER VOLTAGE
vs
FREE-AIR TEMPERATURE

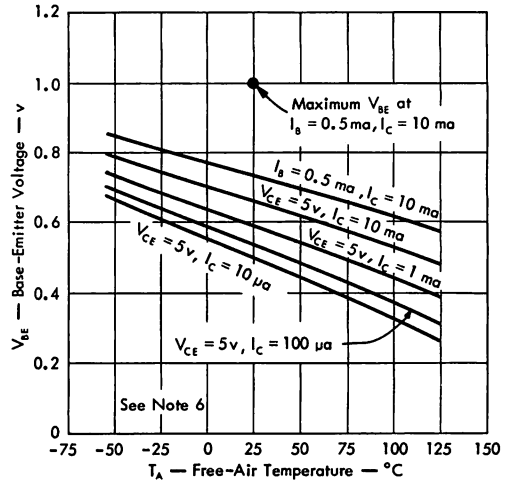

2N929

COLLECTOR-EMITTER SATURATION VOLTAGE
vs
FREE-AIR TEMPERATURE

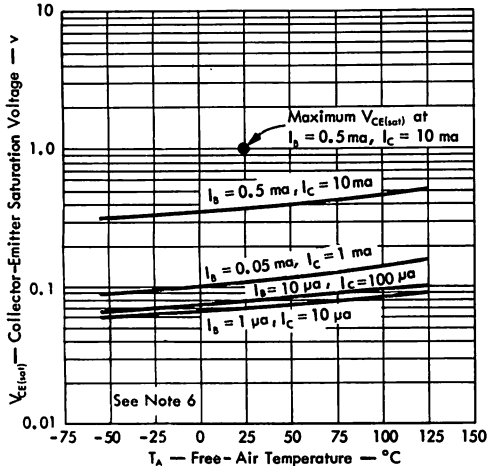

2N930

COLLECTOR-EMITTER SATURATION VOLTAGE
vs
FREE-AIR TEMPERATURE

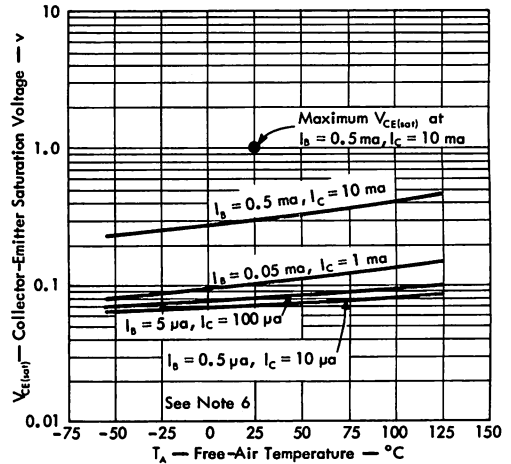

NOTE 6: These parameters were measured using pulse techniques. PW = 300 μ sec, Duty Cycle \leq 2%.

TYPES 2N2192, 2N2192A, 2N2193, 2N2193A, 2N2194, 2N2194A, 2N2243, 2N2243A N-P-N EPITAXIAL PLANAR SILICON TRANSISTORS



TYPES 2N2192 THRU 2N2194, 2N2192A THRU
2N2194A, 2N2243, 2N2243A
BULLETIN NO. DL-5 683371, MARCH 1963
REVISED MAY 1968

FOR MEDIUM-POWER, HIGH-SPEED SWITCHING AND AMPLIFIER APPLICATIONS

- High Breakdown Voltage Combined with Very Low Saturation Voltage
- h_{FE} — Guaranteed from 100 $\mu\alpha$ to 1 amp

*mechanical data

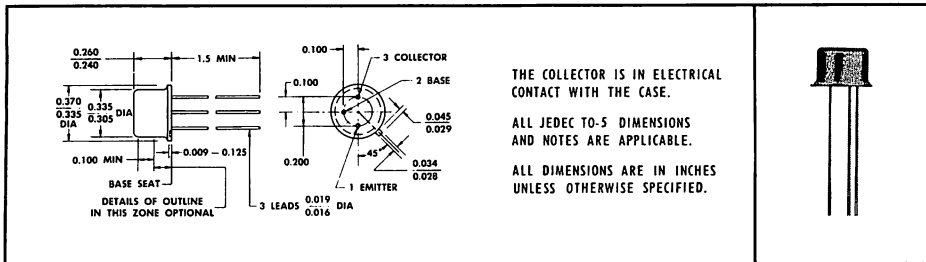

*absolute maximum ratings at 25°C free-air temperature (unless otherwise noted)

	2N2192 2N2192A	2N2193 2N2193A	2N2194 2N2194A	2N2243 2N2243A	UNIT
Collector-Base Voltage	60	80	60	120	v
Collector-Emitter Voltage (See Note 1)	40	50	40	80	v
Emitter-Base Voltage	5	8	5	7	v
Collector Current	1	1	1	1	a
Total Device Dissipation at (or below) 25°C Free-Air Temperature (See Note 2)	0.8	0.8	0.8	0.8	w
Total Device Dissipation at (or below) 25°C Case Temperature (See Note 3)	2.8	2.8	2.8	2.8	w
Total Device Dissipation at 100°C Case Temperature	1.6	1.6	1.6	1.6	w
Operating Collector Junction Temperature Range	-65°C to 200°C				
Storage Temperature Range	-65°C to 200°C				
Lead Temperature $\frac{1}{8}$ Inch from Case for 10 Seconds	300°C				

- NOTES: 1. This value applies when the emitter-base diode is open-circuited.
2. Derate linearly to 200°C free-air temperature at the rate of 4.6 mw/°C.
3. Derate linearly to 200°C case temperature at the rate of 16 mw/°C.

*Indicates JEDEC registered data



TYPES 2N2192, 2N2192A, 2N2193, 2N2193A, 2N2194, 2N2194A, 2N2243, 2N2243A N-P-N EPITAXIAL PLANAR SILICON TRANSISTORS

*electrical characteristics at 25°C free-air temperature (unless otherwise noted)

PARAMETER	TEST CONDITIONS	2N2192 2N2192A		2N2193 2N2193A		2N2194 2N2194A		UNIT
		MIN	MAX	MIN	MAX	MIN	MAX	
BV_{CBO} Collector-Base Breakdown Voltage	$I_C = 100 \mu a, I_E = 0$	60		80		60		v
BV_{CEO} Collector-Emitter Breakdown Voltage	$I_C = 25 \text{ ma}, I_B = 0$, See Note 4	40		50		40		v
BV_{EBO} Emitter-Base Breakdown Voltage	$I_E = 100 \mu a, I_C = 0$	5		8		5		v
I_{CBO} Collector Cutoff Current	$V_{CB} = 30 \text{ v}, I_E = 0$		10				10	na
	$V_{CB} = 30 \text{ v}, I_E = 0, T_A = 150^\circ\text{C}$		15				25	μa
	$V_{CB} = 60 \text{ v}, I_E = 0$				10			na
	$V_{CB} = 60 \text{ v}, I_E = 0, T_A = 150^\circ\text{C}$				25			μa
I_{EBO} Emitter Cutoff Current	$V_{EB} = 3 \text{ v}, I_C = 0$		50				50	na
	$V_{EB} = 5 \text{ v}, I_C = 0$				50			na
h_{FE} Static Forward Current Transfer Ratio	$V_{CE} = 10 \text{ v}, I_C = 100 \mu a$	15		15				
	$V_{CE} = 10 \text{ v}, I_C = 10 \text{ ma}$	75		30		15		
	$V_{CE} = 10 \text{ v}, I_C = 10 \text{ ma}, T_A = -55^\circ\text{C}$	35		20				
	$V_{CE} = 10 \text{ v}, I_C = 150 \text{ ma}$, See Note 4	100	300	40	120	20	60	
	$V_{CE} = 10 \text{ v}, I_C = 500 \text{ ma}$, See Note 4	35		20		12		
	$V_{CE} = 10 \text{ v}, I_C = 1 \text{ a}$, See Note 4	15		15				
V_{BE} Base-Emitter Voltage	$I_B = 15 \text{ ma}, I_C = 150 \text{ ma}$		1.3		1.3		1.3	v
	$V_{CE(sat)}$ Collector-Emitter Saturation Voltage	$I_B = 15 \text{ ma}, I_C = 150 \text{ ma}$	2N2192~2N2194		0.35		0.35	
2N2192A~2N2194A			0.25		0.25		v	
$ h_{fe} $ Small-Signal Common-Emitter Forward Current Transfer Ratio	$V_{CE} = 10 \text{ v}, I_C = 50 \text{ ma}, f = 20 \text{ mc}$	2.5		2.5		2.5		
C_{ob} Common-Base Open-Circuit Output Capacitance	$V_{CB} = 10 \text{ v}, I_E = 0, f = 1 \text{ mc}$		20		20		20	pf

*switching characteristics at 25°C free-air temperature

PARAMETER	TEST CONDITIONS	2N2192 2N2192A 2N2193 2N2193A 2N2194 2N2194A		UNIT
		MAX		
t_r Rise Time	See Figure 1	70		nsec
t_s Storage Time		150		nsec
t_f Fall Time		50		nsec

NOTE 4: These parameters must be measured using pulse techniques. PW = 300 μsec , Duty Cycle $\leq 2\%$.

*Indicates JEDEC registered data

TYPES 2N2192, 2N2192A, 2N2193, 2N2193A, 2N2194, 2N2194A, 2N2243, 2N2243A N-P-N EPITAXIAL PLANAR SILICON TRANSISTORS

*electrical characteristics at 25°C free-air temperature (unless otherwise noted)

PARAMETER	TEST CONDITIONS	2N2243		2N2243A		UNIT
		MIN	MAX	MIN	MAX	
BV_{CBO} Collector-Base Breakdown Voltage	$I_C = 100 \mu a, I_E = 0$	120		120		v
BV_{CEO} Collector-Emitter Breakdown Voltage	$I_C = 25 \text{ ma}, I_B = 0, \text{ See Note 4}$	80		80		v
BV_{EBO} Emitter-Base Breakdown Voltage	$I_E = 100 \mu a, I_C = 0$	7		7		v
I_{CBO} Collector Cutoff Current	$V_{CB} = 60 \text{ v}, I_E = 0$	10		10		na
	$V_{CB} = 60 \text{ v}, I_E = 0, T_A = 150^\circ\text{C}$	15		15		μa
I_{EBO} Emitter Cutoff Current	$V_{EB} = 5 \text{ v}, I_C = 0$	50		50		na
h_{FE} Static Forward Current Transfer Ratio	$V_{CE} = 10 \text{ v}, I_C = 100 \mu a$	15		15		
	$V_{CE} = 10 \text{ v}, I_C = 10 \text{ ma}$	30		30		
	$V_{CE} = 10 \text{ v}, I_C = 10 \text{ ma}, T_A = -55^\circ\text{C}$	20		20		
	$V_{CE} = 10 \text{ v}, I_C = 150 \text{ ma}, \text{ See Note 4}$	40	120	40	120	
	$V_{CE} = 10 \text{ v}, I_C = 500 \text{ ma}, \text{ See Note 4}$	15		15		
	$V_{CE} = 1 \text{ v}, I_C = 150 \text{ ma}, \text{ See Note 4}$	30		30		
V_{BE} Base-Emitter Voltage	$I_B = 15 \text{ ma}, I_C = 150 \text{ ma}$	1.3		1.3		v
$V_{CE(sat)}$ Collector-Emitter Saturation Voltage	$I_B = 15 \text{ ma}, I_C = 150 \text{ ma}$	0.35		0.25		v
$ h_{fo} $ Small-Signal Common-Emitter Forward Current Transfer Ratio	$V_{CE} = 10 \text{ v}, I_C = 50 \text{ ma}, f = 20 \text{ mc}$	2.5		2.5		
C_{ob} Common-Base Open-Circuit Output Capacitance	$V_{CB} = 10 \text{ v}, I_E = 0, f = 1 \text{ mc}$	15		15		pf

*switching characteristics at 25°C free-air temperature

PARAMETER	TEST CONDITIONS	2N2243 2N2243A	UNIT
		MAX	
τ_b Stored-Charge Time Constant	See Figure 2	2.1	μsec

NOTE 4: These parameters must be measured using pulse techniques. PW = 300 μsec , Duty Cycle \leq 2%.

*Indicates JEDEC registered data

TYPES 2N2192, 2N2192A, 2N2193, 2N2193A, 2N2194, 2N2194A, 2N2243, 2N2243A N-P-N EPITAXIAL PLANAR SILICON TRANSISTORS

PARAMETER MEASUREMENT INFORMATION

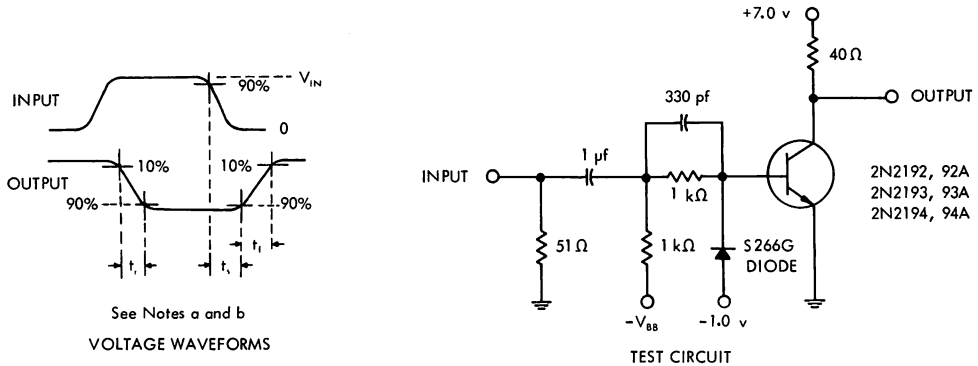

*FIGURE 1 — SWITCHING TIMES — t_r , t_f , t_s

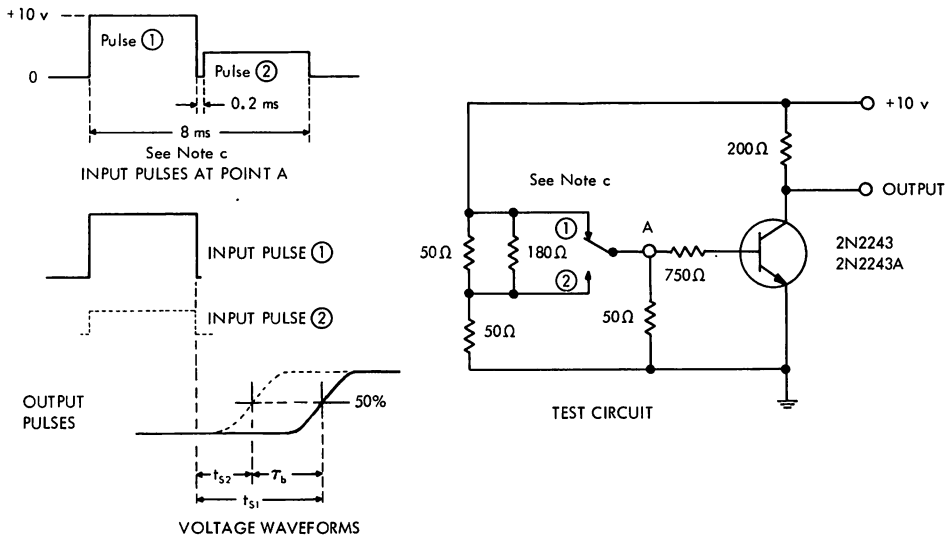

*FIGURE 2 — STORED-CHARGE TIME CONSTANT — τ_b

NOTES: a. The input waveform in Figure 1 is supplied by a generator with the following characteristics: $t_r = 20$ nsec, $t_f = 20$ nsec, $Z_{out} = 50 \Omega$, $PW = 10 \mu\text{sec}$, $PRR = 5$ kc.

b. Waveforms in Figure 1 and Figure 2 are monitored on an oscilloscope with the following characteristics: $t_r \leq 14$ nsec, $R_{in} = 10 \text{ M}\Omega$, $C_{in} = 11.5$ pf.

c. The relay in Figure 2 is Clare HG 1005 (or equivalent).

*Indicates JEDEC registered data

TYPES 2N2217, 2N2218, 2N2219, 2N2220, 2N2221, 2N2222 N-P-N EPITAXIAL PLANAR SILICON TRANSISTORS



TYPES 2N2217, 2N2218, 2N2219, 2N2220, 2N2221, 2N2222
BULLETIN NO. DL-5 653544, MARCH 1963
REVISED OCTOBER 1965

DESIGNED FOR HIGH-SPEED, MEDIUM-POWER SWITCHING AND GENERAL PURPOSE AMPLIFIER APPLICATIONS

- DC Beta — Guaranteed from 100 μ a to 500 ma
- High f_T — 250 mc min at 20v, 20 ma

environmental tests

To ensure maximum integrity, stability, and long life, all finished transistors are subjected to sustained acceleration at a minimum of 35,000 G and verification of hermetic seal by helium leak testing.

*mechanical data

Device types 2N2217, 2N2218, and 2N2219 are in JEDEC TO-5 packages.
Device types 2N2220, 2N2221, and 2N2222 are in JEDEC TO-18 packages.

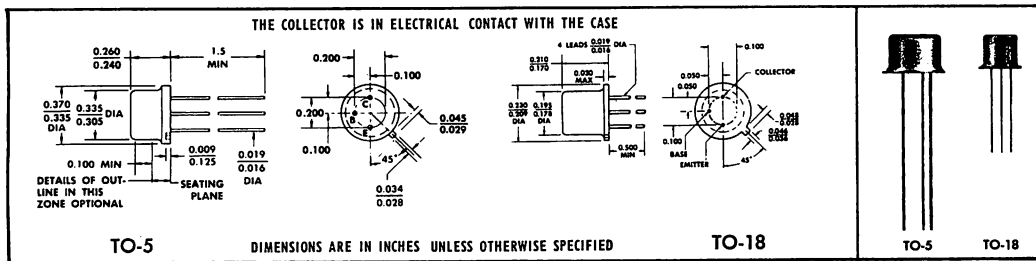

*absolute maximum ratings at 25°C free-air temperature (unless otherwise noted)

	2N2217	2N2220
Collector-Base Voltage	60 v	60 v
Collector-Emitter Voltage (See Note 1)	30 v	30 v
Emitter-Base Voltage	5 v	5 v
Collector Current	0.8 a	0.8 a
Total Device Dissipation at (or below) 25°C Free-Air Temperature (See Notes 2 and 3)	0.8 w	0.5 w
Total Device Dissipation at (or below) 25°C Case Temperature (See Notes 4 and 5)	3 w	1.8 w
Operating Collector Junction Temperature Range	- 65°C to + 175°C	
Storage Temperature Range	- 65°C to + 200°C	

- NOTES: 1. This value applies when the base-emitter diode is open-circuited.
2. Derate 2N2217, 2N2218, and 2N2219 linearly to 175°C free-air temperature at the rate of 5.33 mw/°C.
3. Derate 2N2220, 2N2221, and 2N2222 linearly to 175°C free-air temperature at the rate of 3.33 mw/°C.
4. Derate 2N2217, 2N2218, and 2N2219 linearly to 175°C case temperature at the rate of 20.0 mw/°C.
5. Derate 2N2220, 2N2221, and 2N2222 linearly to 175°C case temperature at the rate of 12.0 mw/°C.

*Indicates JEDEC registered data



TEXAS INSTRUMENTS
INCORPORATED
POST OFFICE BOX 5012 • DALLAS, TEXAS 75222

TYPES 2N2217, 2N2218, 2N2219, 2N2220, 2N2221, 2N2222

N-P-N EPITAXIAL PLANAR SILICON TRANSISTORS

*electrical characteristics at 25°C free-air temperature (unless otherwise noted)

PARAMETER	TEST CONDITIONS	TO-5 →	2N2217			2N2218			2N2219			UNIT
		TO-18 →	2N2220			2N2221			2N2222			
			MIN	TYP	MAX	MIN	TYP	MAX	MIN	TYP	MAX	
V_{CBO} Collector-Base Breakdown Voltage	$I_C = 10 \mu a, I_E = 0$	60			60			60			v	
V_{CEO} Collector-Emitter Breakdown Voltage	$I_C = 10 ma, I_B = 0$	30			30			30			v	
V_{EBO} Emitter-Base Breakdown Voltage	$I_E = 10 \mu a, I_C = 0$	5			5			5			v	
I_{CBO} Collector Cutoff Current	$V_{CB} = 50 v, I_E = 0$			10			10			10	na	
	$V_{CB} = 50 v, I_E = 0, T_A = 150^\circ C$			10			10			10	μa	
I_{EBO} Emitter Cutoff Current	$V_{EB} = 3 v, I_C = 0$			10			10			10	na	
h_{FE} Static Forward Current Transfer Ratio	$V_{CE} = 10 v, I_C = 100 \mu a$				20			35				
	$V_{CE} = 10 v, I_C = 1 ma$	12			25			50				
	$V_{CE} = 10 v, I_C = 10 ma$	17			35			75				
	$V_{CE} = 10 v, I_C = 150 ma, (See Note 6)$	20		60	40		120	100		300		
	$V_{CE} = 10 v, I_C = 500 ma, (See Note 6)$				20			30				
	$V_{CE} = 1 v, I_C = 150 ma, (See Note 6)$	10			20			50				
V_{BE} Base-Emitter Voltage	$I_B = 15 ma, I_C = 150 ma, (See Note 6)$	0.9	1.3		0.9	1.3		0.9	1.3		v	
	$I_B = 50 ma, I_C = 500 ma, (See Note 6)$	1.2			1.2	2.6		1.2	2.6		v	
$V_{CE(sat)}$ Collector-Emitter Saturation Voltage	$I_B = 15 ma, I_C = 150 ma, (See Note 6)$	0.2	0.4		0.2	0.4		0.2	0.4		v	
	$I_B = 50 ma, I_C = 500 ma, (See Note 6)$	0.5			0.4	1.6		0.4	1.6		v	
$ h_{fe} $ Small-Signal Common-Emitter Forward Current Transfer Ratio	$V_{CE} = 20 v, I_C = 20 ma, f = 100 mc$	2.5	2.8		2.5	3.0		2.5	3.5			
f_T Transition Frequency	$V_{CE} = 20 v, I_C = 20 ma, (See Note 7)$	250	280		250	300		250	350		mc	
C_{ob} Common-Base Open-Circuit Output Capacitance	$V_{CB} = 10 v, I_E = 0, f = 1 mc$	5	8		5	8		5	8		pf	
C_{ib} Common-Base Open-Circuit Input Capacitance	$V_{EB} = 0.5 v, I_C = 0, f = 1 mc$	23			23			23			pf	
$Re(h_{io})$ Real Part of Small-Signal Common-Emitter Input Impedance	$V_{CE} = 20 v, I_C = 20 ma, f = 300 mc$	15	60		15	60		15	60		ohm	

NOTES: 6. These parameters must be measured using pulse techniques. PW = 300 μsec , Duty Cycle $\leq 2\%$.

7. To obtain f_T , the $|h_{fe}|$ response with frequency is extrapolated at the rate of -6db per octave from $f = 100 mc$ to the frequency at which $|h_{fe}| = 1$.

*Indicates JEDEC registered data (typical data excluded)

TYPES 2N2217, 2N2218, 2N2219, 2N2220, 2N2221, 2N2222

N-P-N EPITAXIAL PLANAR SILICON TRANSISTORS

switching characteristics at 25°C free-air temperature

PARAMETER	TEST CONDITIONS††	TO-5 →	2N2217	2N2218	2N2219	UNIT
		TO-18 →	2N2220	2N2221	2N2222	
TYPICAL						
t_{on} Turn-On Time	$I_C = 150 \text{ ma}$, $I_{B(1)} = 15 \text{ ma}$, $I_{B(2)} = -15 \text{ ma}$		25	25	25	nsec
t_{off} Turn-Off Time	$V_{BE(off)} = -2.75 \text{ v}$, $R_L = 40 \Omega$, (See Figure 1)		150	175	200	nsec
t_T Total Switching Time	See Figure 2		9	9	9	nsec

†† Voltage and current values shown are nominal; exact values vary slightly with device parameters.

PARAMETER MEASUREMENT INFORMATION

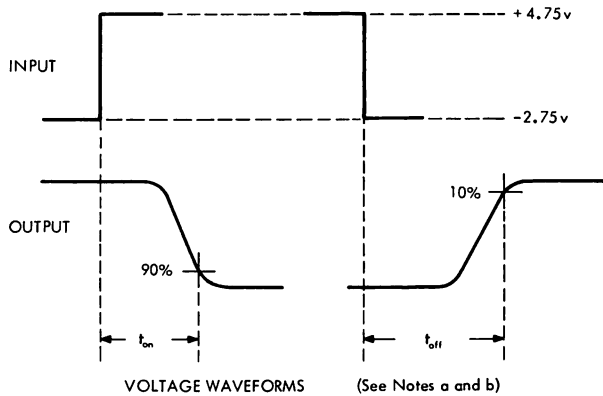
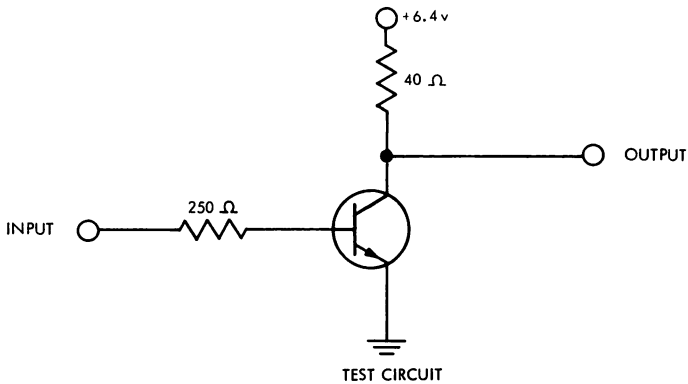

FIGURE 1 - SATURATED SWITCHING CIRCUIT FOR TURN-ON AND TURN-OFF TIMES

NOTES: a. The input waveforms in Figure 1 have the following characteristics: $t_r \leq 1 \text{ nsec}$, $PW \geq 300 \text{ nsec}$.

b. All waveforms are monitored on an oscilloscope with the following characteristics: $t_r \leq 4 \text{ nsec}$, $R_{in} \geq 100 \text{ K}\Omega$, $C_{in} \leq 12 \text{ pf}$.

TYPES 2N2217, 2N2218, 2N2219, 2N2220, 2N2221, 2N2222 N-P-N EPITAXIAL PLANAR SILICON TRANSISTORS

PARAMETER MEASUREMENT INFORMATION

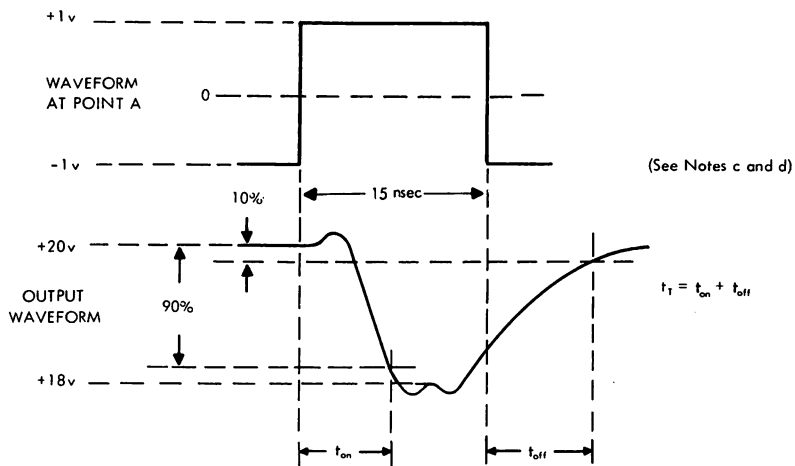
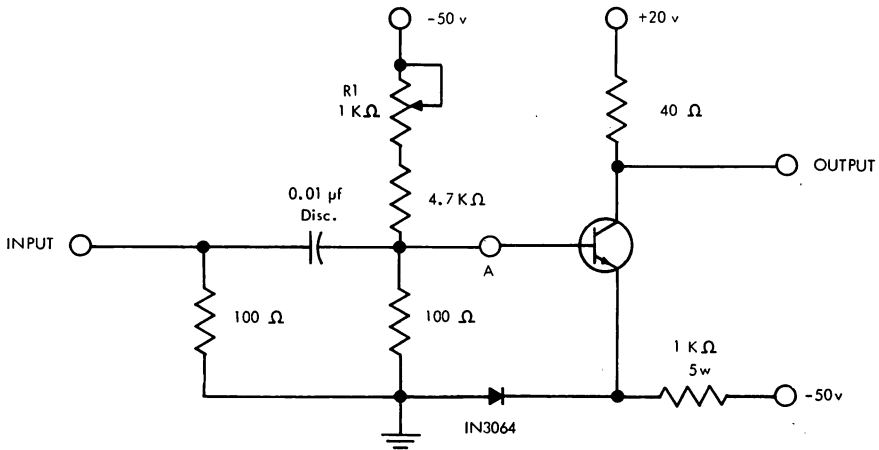

FIGURE 2. NON-SATURATED SWITCHING TIME MEASUREMENT CIRCUIT

NOTES: c. The input waveform is supplied by a mercury relay pulse generator with the following characteristics: $t_r \leq 1$ nsec, $t_f \leq 1$ nsec, PW = 15 nsec. Adjust R1 and the input pulse amplitude to obtain the specified voltage levels at Point A.

d. Waveforms are monitored on a sampling oscilloscope ($t_r \leq 0.8$ nsec) using a 2000 Ω probe.

TYPE 2N2369A N-P-N EPITAXIAL PLANAR SILICON TRANSISTOR



DESIGNED FOR VERY-HIGH-SPEED SWITCHING APPLICATIONS

***mechanical data**

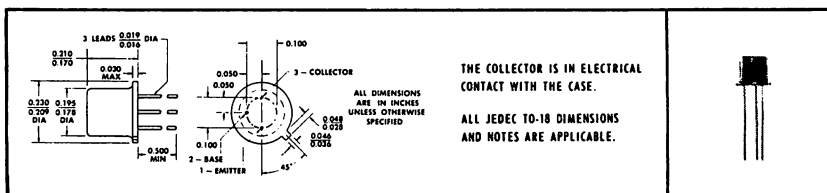

***absolute maximum ratings at 25°C free-air temperature (unless otherwise noted)**

Collector-Base Voltage	40 v
Collector-Emitter Voltage (See Note 1)	40 v
Collector-Emittor Voltage (See Note 2)	15 v
Emitter-Base Voltage	4.5 v
Continuous Collector Current	200 ma
Peak Collector Current (See Note 3)	500 ma
Continuous Device Dissipation at (or below) 25°C Free-Air Temperature (See Note 4)	0.36 w
Continuous Device Dissipation at (or below) 25°C Case Temperature (See Note 5)	1.2 w
Continuous Device Dissipation at 100°C Case Temperature	0.68 w
Operating Collector Junction Temperature	200°C
Storage Temperature Range	-65°C to 200°C
Lead Temperature 1/8 Inch from Case for 60 Seconds	300°C

***electrical characteristics at 25°C free-air temperature (unless otherwise noted)**

PARAMETER	TEST CONDITIONS	MIN	MAX	UNIT
$V_{(BR)CBO}$ Collector-Base Breakdown Voltage	$I_C = 10 \mu A, I_E = 0$	40		v
$V_{(BR)ICEO}$ Collector-Emitter Breakdown Voltage	$I_C = 10 \text{ ma}, I_B = 0$, See Note 6	15		v
$V_{(BR)CES}$ Collector-Emitter Breakdown Voltage	$I_C = 10 \mu A, V_{BE} = 0$	40		v
$V_{(BR)EBO}$ Emitter-Base Breakdown Voltage	$I_E = 10 \mu A, I_C = 0$	4.5		v
I_{CBO} Collector Cutoff Current	$V_{CB} = 20 \text{ v}, I_E = 0, T_A = 150^\circ C$		30	μA
I_{CES} Collector Cutoff Current	$V_{CE} = 20 \text{ v}, V_{BE} = 0$		0.4	μA
I_B Base Current	$V_{CE} = 20 \text{ v}, V_{BE} = 0$		-0.4	μA
h_{FE} Static Forward Current Transfer Ratio	$V_{CE} = 0.35 \text{ v}, I_C = 10 \text{ ma}$, See Note 6	40		
	$V_{CE} = 1 \text{ v}, I_C = 10 \text{ ma}$, See Note 6		120	
	$V_{CE} = 0.4 \text{ v}, I_C = 30 \text{ ma}$, See Note 6	30		
	$V_{CE} = 1 \text{ v}, I_C = 100 \text{ ma}$, See Note 6	20		
	$V_{CE} = 0.35 \text{ v}, I_C = 10 \text{ ma}, T_A = -55^\circ C$, See Note 6	20		
V_{BE} Base-Emitter Voltage	$I_B = 1 \text{ ma}, I_C = 10 \text{ ma}$	0.7	0.85	v
	$I_B = 3 \text{ ma}, I_C = 30 \text{ ma}$		1.15	v
	$I_B = 10 \text{ ma}, I_C = 100 \text{ ma}$		1.6	v
	$I_B = 1 \text{ ma}, I_C = 10 \text{ ma}, T_A = 125^\circ C$	0.59		v
	$I_B = 1 \text{ ma}, I_C = 10 \text{ ma}, T_A = -55^\circ C$		1.02	v
$V_{CE(sat)}$ Collector-Emitter Saturation Voltage	$I_B = 1 \text{ ma}, I_C = 10 \text{ ma}$		0.2	v
	$I_B = 3 \text{ ma}, I_C = 30 \text{ ma}$		0.25	v
	$I_B = 10 \text{ ma}, I_C = 100 \text{ ma}$		0.5	v
	$I_B = 1 \text{ ma}, I_C = 10 \text{ ma}, T_A = 125^\circ C$		0.3	v
$ h_{fe} $ Small-Signal Common-Emitter Forward Current Transfer Ratio	$V_{CE} = 10 \text{ v}, I_C = 20 \text{ ma}, f = 100 \text{ Mc}$	5		
C_{obo} Common-Base Open-Circuit Output Capacitance	$V_{CB} = 5 \text{ v}, I_E = 0, f = 140 \text{ kc}$	4		pf

NOTES: 1. This value applies when the base-emitter diode is short-circuited.

2. This value applies between 10 μA and 10 ma collector current when the base-emitter diode is open-circuited.

3. This value applies for $PW \leq 10 \mu sec$.

*Indicates JEDEC registered data

4. Derate linearly to 200°C free-air temperature at the rate of 2.06 mw/°C.

5. Derate linearly to 200°C case temperature at the rate of 6.85 mw/°C.

6. These parameters must be measured using pulse techniques. $PW = 300 \mu sec$, Duty Cycle $\leq 2\%$.

TYPE 2N2369A
BULLETIN NO. DL-S 658082, SEPTEMBER 1965
REPLACES BULLETIN NO. DL-S 645609 JUNE 1964



TEXAS INSTRUMENTS
INCORPORATED
POST OFFICE BOX 5012 • DALLAS, TEXAS 75222

TYPE 2N2369A

N-P-N EPITAXIAL PLANAR SILICON TRANSISTOR

*switching characteristics at 25°C free-air temperature

PARAMETER	TEST CONDITIONS†	MAX	UNIT
t_{on} Turn-On Time	$I_C = 10 \text{ ma}$, $I_{B(1)} = 3 \text{ ma}$, $I_{B(2)} = -1.5 \text{ ma}$,	12	nsec
t_{off} Turn-Off Time	$V_{BE(off)} = -1.5 \text{ v}$, $R_L = 250 \Omega$, See Figure 1	18	nsec
t_s Storage Time	$I_C = I_{B(1)} = 10 \text{ ma}$, $I_{B(2)} = -10 \text{ ma}$, See Figure 2	13	nsec

†Voltage and current values shown are nominal; exact values vary slightly with transistor parameters.

*PARAMETER MEASUREMENT INFORMATION

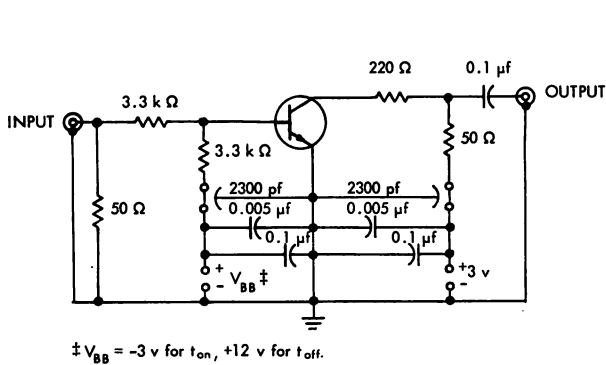

TEST CIRCUIT

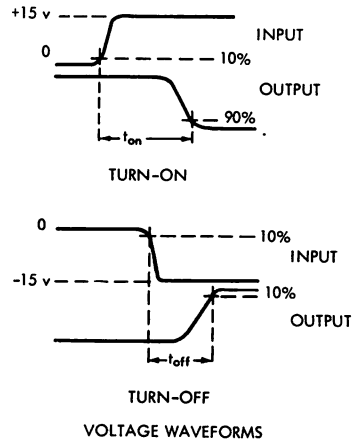
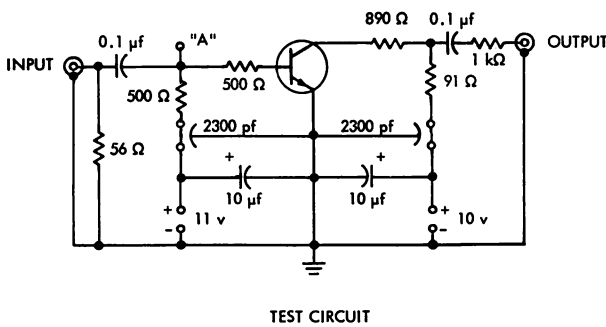

FIGURE 1 — TURN-ON AND TURN-OFF TIMES



TEST CIRCUIT

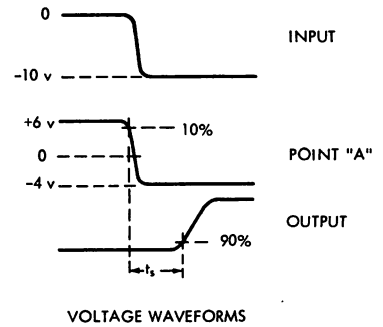

FIGURE 2 — STORAGE TIME

NOTES: a. The input waveforms are supplied by a pulse generator with the following characteristics: $Z_{out} = 50 \Omega$, $t_r \leq 1 \text{ nsec}$, $PW > 300 \text{ nsec}$, Duty Cycle $\leq 2\%$.
b. Output waveforms are monitored on an oscilloscope with the following characteristics: $t_r \leq 1 \text{ nsec}$, $Z_{in} = 50 \Omega$.

*Indicates JEDEC registered data

TYPES 2N2432, 2N2432A, 2N4138 N-P-N EPITAXIAL PLANAR SILICON TRANSISTORS



FOR LOW-LEVEL, HIGH-SPEED CHOPPER APPLICATIONS IN INVERTED CONNECTION

- Low Offset Voltage... 0.4 mV Max (2N2432A)
- Low I_{ECS} ... 2 nA Max
- High Rated V_{ECO} for Inverted Connection

ALSO USEFUL FOR LOW-LEVEL AMPLIFIER APPLICATIONS

- h_{FE} ... 30 Min at 10 μ A

TYPES 2N2432, 2N2432A, 2N4138
BULLETIN NO. DL-5-669079, OCTOBER 1966, REVISED JANUARY 1968
REPLACES BULLETINS NO. DL-5-622467, MARCH 1962
AND DL-5-668381, MARCH 1966

***mechanical data**

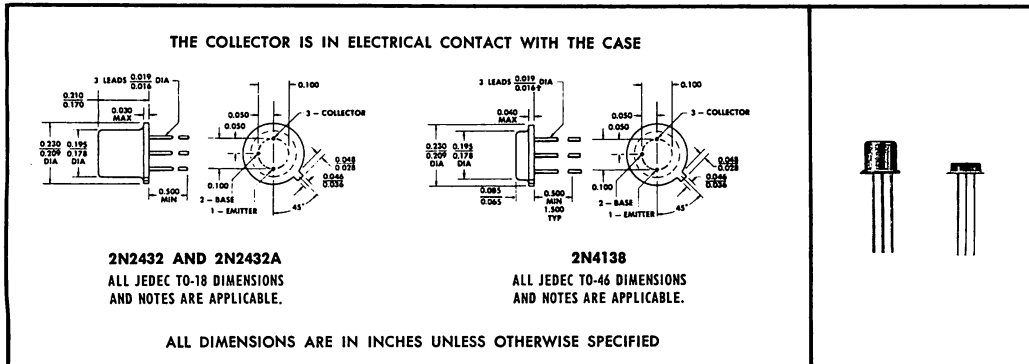

†TI guaranteed minimum. The JEDEC registered minimum lead diameter for the TO-46 is 0.012.

***absolute maximum ratings at 25°C free-air temperature (unless otherwise noted)**

	2N2432	2N2432A 2N4138
Collector-Base Voltage	30 V	45 V
Collector-Emitter Voltage (See Note 1)	30 V	45 V
Emitter-Collector Voltage (See Note 2)	15 V	18 V
Emitter-Base Voltage	15 V	18 V
Continuous Collector Current	← 100 mA →	
Continuous Device Dissipation at (or below) 25°C Free-Air Temperature (See Note 3)	← 300 mW →	
Continuous Device Dissipation at (or below) 25°C Case Temperature (See Note 4)	← 600 mW →	
Storage Temperature Range	← -65°C to 200°C →	
Lead Temperature 1/8 Inch from Case for 10 Seconds	← 300°C →	

- NOTES: 1. This value applies between 0 and 10 mA collector current when the emitter-base diode is open-circuited.
 2. This value applies between 0 and 100 μ A emitter current when the collector-base diode is open-circuited.
 3. Derate linearly to 175°C free-air temperature at the rate of 2 mW/deg.
 4. Derate linearly to 175°C case temperature at the rate of 4 mW/deg.

*Indicates JEDEC registered data.



TEXAS INSTRUMENTS
INCORPORATED
POST OFFICE BOX 5012 • DALLAS, TEXAS 75222

TYPES 2N2432, 2N2432A, 2N4138

N-P-N EPITAXIAL PLANAR SILICON TRANSISTORS

*electrical characteristics at 25°C free-air temperature (unless otherwise noted)

PARAMETER	TEST CONDITIONS	2N2432	2N4138	UNIT
		MIN	MAX	
$V_{(BR)CBO}$ Collector-Base Breakdown Voltage	$I_C = 100 \mu A, I_E = 0$	30	45	V
$V_{(BR)CEO}$ Collector-Emitter Breakdown Voltage	$I_C = 10 \text{ mA}, I_B = 0$, See Note 5	30	45	V
$V_{(BR)ECO}$ Emitter-Collector Breakdown Voltage	$I_E = 100 \mu A, I_B = 0$	15	18	V
I_{CBO} Collector Cutoff Current	$V_{CB} = 25 \text{ V}, I_E = 0$	10		nA
	$V_{CB} = 40 \text{ V}, I_E = 0$		10	nA
I_{CES} Collector Cutoff Current	$V_{CE} = 25 \text{ V}, V_{BE} = 0$	10		nA
	$V_{CE} = 25 \text{ V}, V_{BE} = 0, T_A = 125^\circ\text{C}$	250		nA
	$V_{CE} = 40 \text{ V}, V_{BE} = 0$		10	nA
	$V_{CE} = 40 \text{ V}, V_{BE} = 0, T_A = 125^\circ\text{C}$		250	nA
I_{EBO} Emitter Cutoff Current	$V_{EB} = 15 \text{ V}, I_C = 0$	2	2	nA
I_{ECS} Emitter Cutoff Current	$V_{EC} = 15 \text{ V}, V_{BC} = 0$	2	2	nA
	$V_{EC} = 15 \text{ V}, V_{BC} = 0, T_A = 125^\circ\text{C}$	200	200	nA
h_{FE} Static Forward Current Transfer Ratio	$V_{CE} = 5 \text{ V}, I_C = 10 \mu A$	30	30	
	$V_{CE} = 5 \text{ V}, I_C = 1 \text{ mA}$	50	50	
$h_{FE(inv)}$ Static Forward Current Transfer Ratio (Inverted Connection)	$V_{EC} = 5 \text{ V}, I_E = 0.2 \text{ mA}$	2	3	
$V_{CE(sat)}$ Collector-Emitter Saturation Voltage	$I_B = 0.5 \text{ mA}, I_C = 10 \text{ mA}$	0.15	0.15	V
$V_{EC(ofs)}$ Offset Voltage (Inverted Connection)	$I_B = 200 \mu A, I_E = 0$, See Figure 1	0.5	0.4	mV
	$I_B = 1 \text{ mA}, I_E = 0$, See Figure 1	1	0.7	mV
$r_{ec(on)}$ Small-Signal Emitter-Collector On-State Resistance	$I_B = 1 \text{ mA}, I_E = 0, I_o = 100 \mu A, f = 1 \text{ kHz}$, See Figure 2	20	15	Ω
$ h_{fe} $ Small-Signal Common-Emitter Forward Current Transfer Ratio	$V_{CE} = 5 \text{ V}, I_C = 1 \text{ mA}, f = 20 \text{ MHz}$	1	1	
C_{obo} Common-Base Open-Circuit Output Capacitance	$V_{CB} = 0, I_E = 0, f = 140 \text{ kHz}$	12	12	pF
C_{cb} Collector-Base Capacitance	$V_{CB} = 0, I_E = 0, f = 1 \text{ MHz}$, See Note 6	12	12	pF
C_{ibo} Common-Base Open-Circuit Input Capacitance	$V_{EB} = 0, I_C = 0, f = 140 \text{ kHz}$	12	12	pF
C_{eb} Emitter-Base Capacitance	$V_{EB} = 0, I_C = 0, f = 1 \text{ MHz}$, See Note 6	12	12	pF

NOTES: 5. This parameter must be measured using pulse techniques. $t_p = 300 \mu s$, duty cycle $\leq 2\%$.

6. C_{cb} and C_{eb} are measured using three-terminal measurement techniques with the third electrode (emitter or collector respectively) guarded.

PARAMETER MEASUREMENT INFORMATION

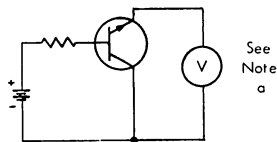

FIGURE 1

MEASUREMENT CIRCUIT FOR OFFSET VOLTAGE

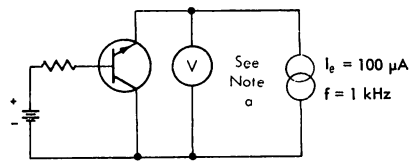

FIGURE 2

MEASUREMENT CIRCUIT FOR EMITTER-COLLECTOR ON-STATE RESISTANCE

$$r_{ec(on)} = \frac{V_{ec}}{I_e}$$

NOTE a: The voltmeter must have high enough impedance that halving the value of the voltmeter impedance does not change the measured value.

*Indicates JEDEC registered data.

TYPES 2N2432, 2N2432A, 2N4138

N-P-N EPITAXIAL PLANAR SILICON TRANSISTORS

TYPICAL CHARACTERISTICS

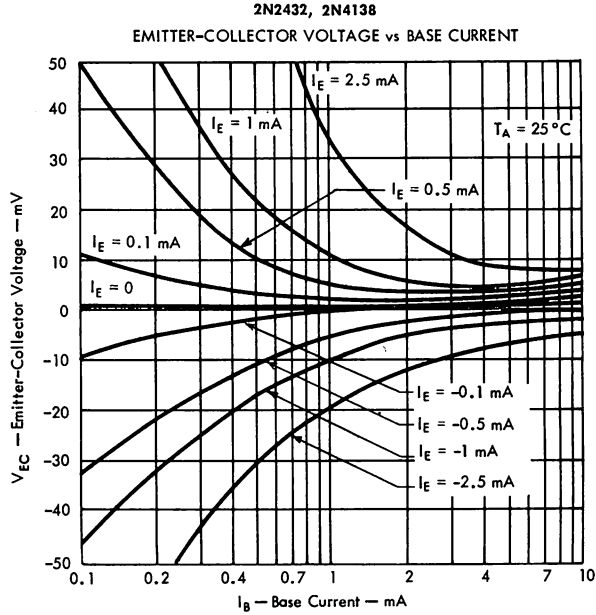

FIGURE 3

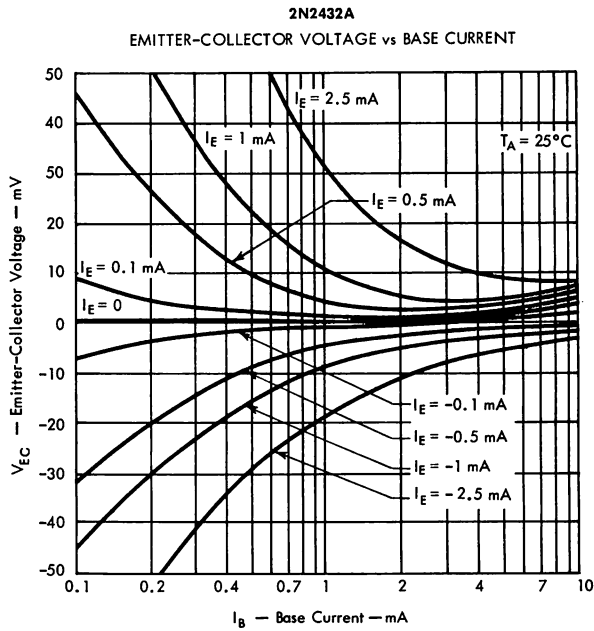
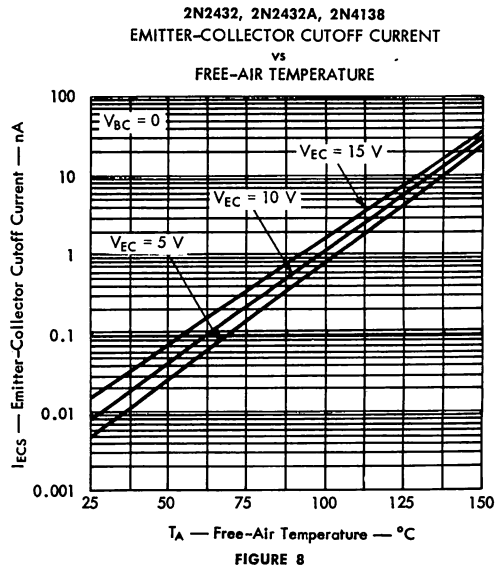
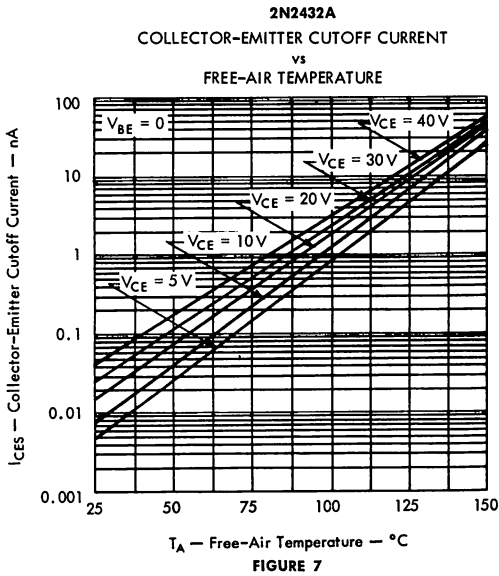
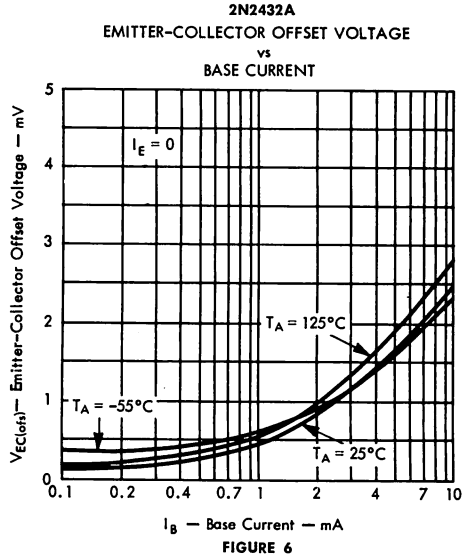
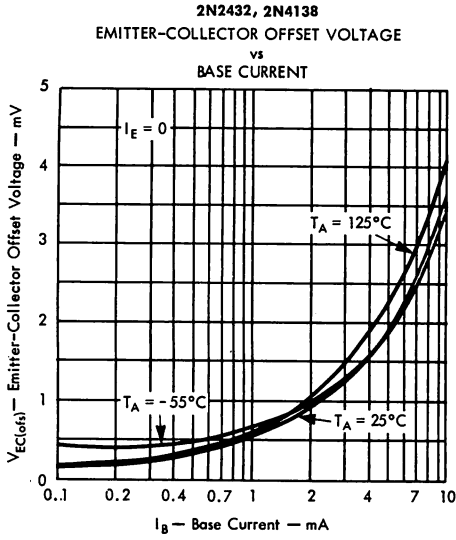

FIGURE 4

TYPES 2N2432, 2N2432A, 2N4138 N-P-N EPITAXIAL PLANAR SILICON TRANSISTORS

TYPICAL CHARACTERISTICS



TYPES 2N2432, 2N2432A, 2N4138 N-P-N EPITAXIAL PLANAR SILICON TRANSISTORS

TYPICAL CHARACTERISTICS

2N2432, 2N2432A, 2N4138
STATIC FORWARD CURRENT TRANSFER RATIO
vs
COLLECTOR CURRENT

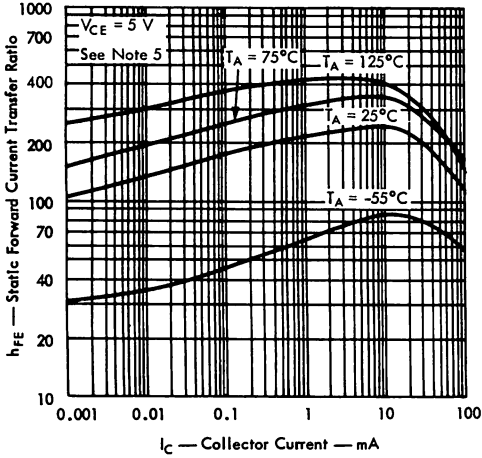

FIGURE 9

2N2432, 2N2432A, 2N4138
STATIC FORWARD CURRENT TRANSFER RATIO
vs
COLLECTOR CURRENT

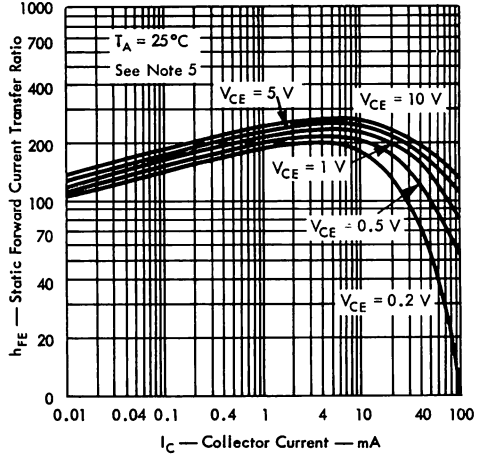

FIGURE 10

2N2432, 2N4138
STATIC FORWARD CURRENT TRANSFER RATIO
(INVERTED CONNECTION)
vs
EMITTER CURRENT

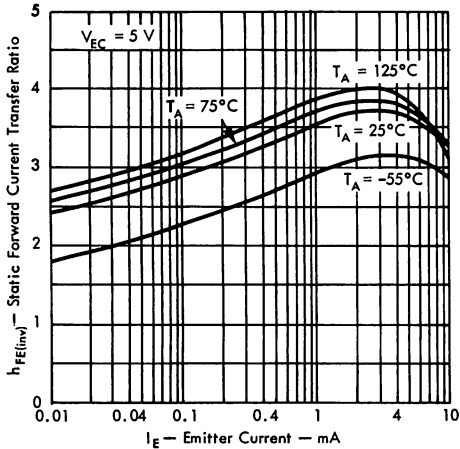

FIGURE 11

2N2432A
STATIC FORWARD CURRENT TRANSFER RATIO
(INVERTED CONNECTION)
vs
EMITTER CURRENT

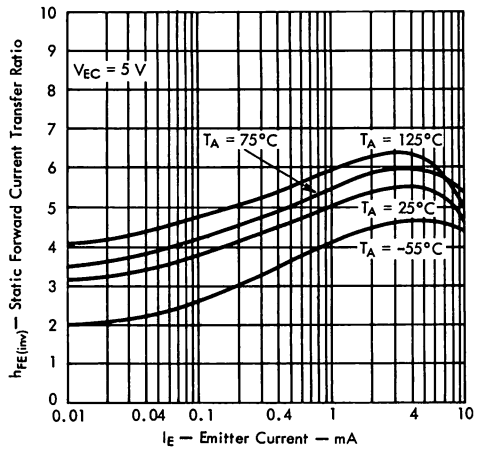

FIGURE 12

NOTE 5: This parameter must be measured using pulse techniques. $t_p = 300\ \mu\text{s}$, duty cycle $\leq 2\%$.

TYPES 2N2432, 2N2432A, 2N4138

N-P-N EPITAXIAL PLANAR SILICON TRANSISTORS

TYPICAL CHARACTERISTICS

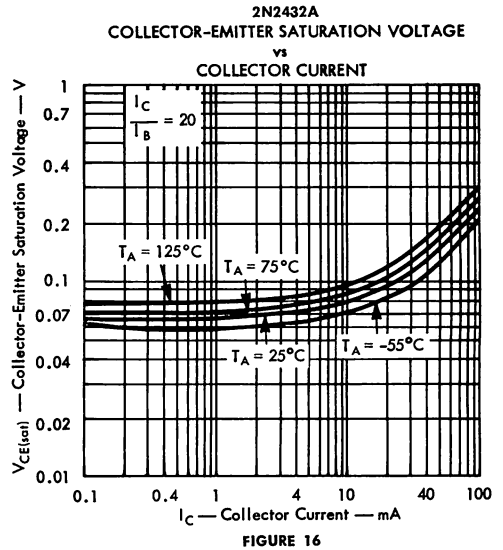
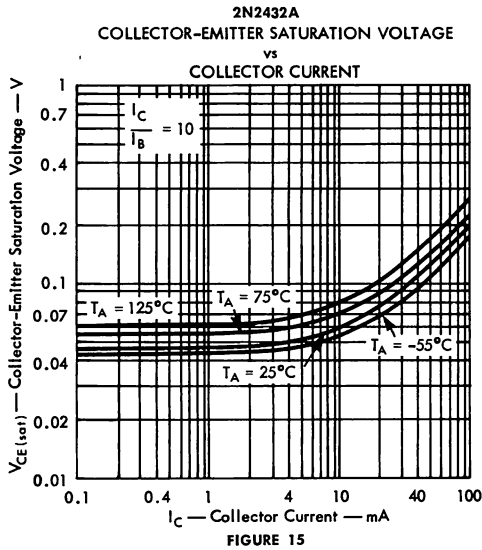
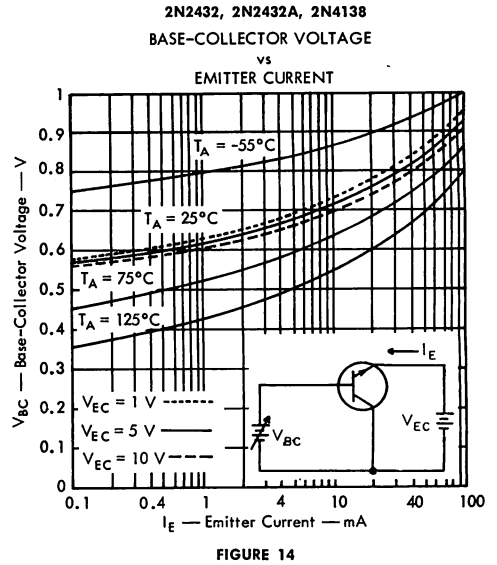
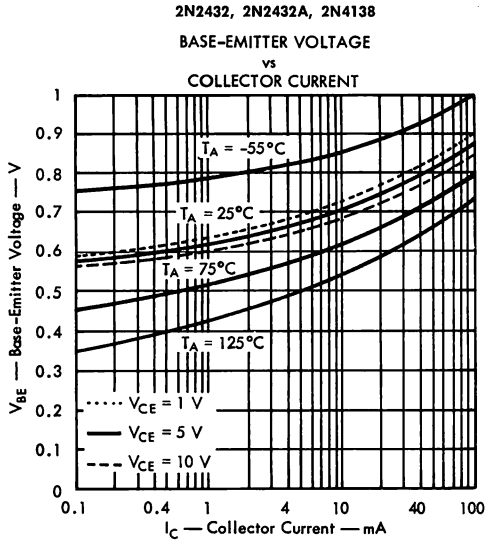

TYPES 2N2432, 2N2432A, 2N4138 N-P-N EPITAXIAL PLANAR SILICON TRANSISTORS

TYPICAL CHARACTERISTICS

2N2432, 2N4138

SMALL-SIGNAL EMITTER-COLLECTOR ON-STATE RESISTANCE

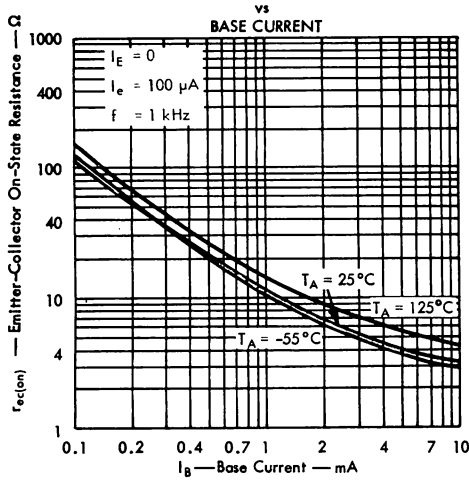

FIGURE 17

2N2432A

SMALL-SIGNAL EMITTER-COLLECTOR ON-STATE RESISTANCE

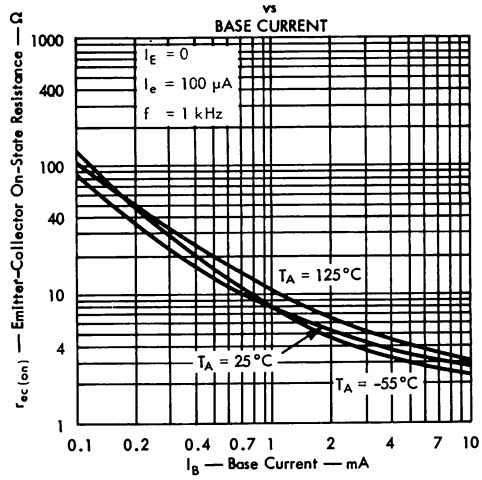

FIGURE 18

2N2432, 2N2432A, 2N4138

EMITTER-BASE CAPACITANCE

vs
EMITTER-BASE VOLTAGE

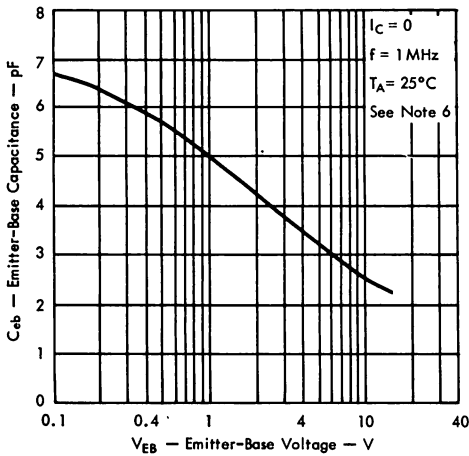

FIGURE 19

2N2432, 2N2432A, 2N4138

COLLECTOR-BASE CAPACITANCE

vs
COLLECTOR-BASE VOLTAGE

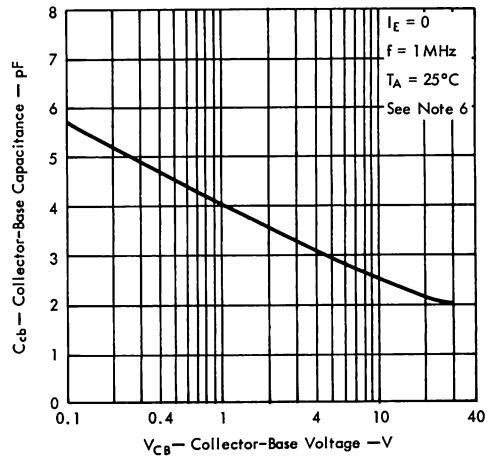

FIGURE 20

NOTE 6: C_{cb} and C_{eb} are measured using three-terminal measurement techniques with the third electrode (emitter or collector respectively) guarded.

TI World-Wide Sales Offices

ALABAMA

Sahara Office Park Bldg., Suite 111
3313 Memorial Parkway, S.W.
Huntsville, Alabama 35801
205-881-4061

ARIZONA

2535 W. Camelback Rd., Suite 1D
Phoenix, Arizona 85017
602-279-5531

CALIFORNIA

1800 North Argyle Ave.
Hollywood, California 90028
213-466-7251

5005 West Century Blvd., Suite 208
Inglewood, California 90301
213-673-3943

230 California Ave., Suite 201
Palo Alto, California 94306
415-326-6770

1505 East 17th St., Suite 201
Santa Ana, California 92701
714-547-6506

4185 Adams Ave.
San Diego, California 92116
714-284-1181

COLORADO

2186 South Holly St., Suite 204
Denver, Colorado 80222
303-757-8548

CONNECTICUT

300 Amity Road
Woodbridge, Connecticut 06525
203-389-4521

FLORIDA

618 East South St., Suite 114
Orlando, Florida 32801
305-422-9894

ILLINOIS

Suite 205, Executive Towers
5901 N. Cicero Ave.
Chicago, Illinois 60646
312-286-1000

MASSACHUSETTS

60 Hickory Drive
Waltham, Mass. 02154
617-891-8450

MICHIGAN

Suite 706 West, Northland Towers Bldg.
15565 Northland Dr.
Southfield, Michigan 48075
313-357-1703

MINNESOTA

7615 Metro Blvd.
Suite 202, U.C.L.I. Bldg.
Edina, Minn. 55424
612-941-4384

NEW JERSEY

U.S. Highway #22
P.O. Box 366
Union, New Jersey 07083
201-687-7200

NEW YORK

P. O. Box 87, 2209 E. Main
Endicott, New York 13760
607-785-9987

4 Nevada Drive
New Hyde Park, N. Y. 11040
516-488-9894

131 Fulton Ave., Apt. J-2
Poughkeepsie, New York 12603
914-471-6095

6563 Ridings Rd.
Syracuse, New York 13206
315-463-9291

OHIO

22035 Chagrin Blvd.
Cleveland, Ohio 44122
216-751-2600

Suite 205, Paul Welch Bldg.
3300 South Dixie Dr.
Dayton, Ohio 45439
513-298-7513

PENNSYLVANIA

Benjamin Fox Pavilion
Suite 424, Foxcroft Square
Jenkintown, Pa. 19046
215-885-3454

TEXAS

MS80 — P.O. Box 5012
Dallas, Texas 75222
214-238-4861

3609 Buffalo Speedway
Houston, Texas 77006
713-526-3268

WASHINGTON

5801 Sixth Ave. S.
Seattle, Washington 98108
206-762-4240

WASHINGTON, D.C.

1875 Connecticut Ave., N.W., Suite 913
Washington, D.C. 20009
202-234-9320

CANADA

Geophysical Service Incorporated
280 Centre Str. East
Richmond Hills
Ontario, Canada
925-1035

663 Orly Avenue
Dorval
Quebec, Canada
631-6010

EUROPE

Texas Instruments Limited
Manton Lane
Bedford, England

Texas Instruments France S. A.
Boite Postale 5
Villeneuve-Loubet (A.M.), France

11 rue de Madrid
Paris 8^e, France

Texas Instruments Holland N.V.
Semiconductor Division
Enschedesestraat 19
Hengelo (Ov), Holland

Texas Instruments Italia S.p.A.
Via Colautti 1
Milan, Italy

Texas Instruments Incorporated
118 Rue du Rhone
1204 Geneva, Switzerland

Texas Instruments Sweden A.B.
Timmermangatan 34, Box 17116
Stockholm 17, Sweden

Texas Instruments Deutschland GmbH
Hildesheimerstr. 19
3 Hannover, W. Germany

Texas Instruments Deutschland GmbH
Wolframstrasse 26
7 Stuttgart
West Germany

Texas Instruments Deutschland GmbH
Clemensstrasse 30
8 Munich 23
West Germany

Texas Instruments Deutschland GmbH
Kepserstrasse 33
805 Freising-Lerchenfeld
West Germany

Texas Instruments Deutschland GmbH
Koenigsbacherstrasse 22
6 Frankfurt, West Germany

MEXICO

Texas Instruments de Mexico S.A.
Poniente 116 #489
Col. Ind. Vallejo
Mexico 15, D.F.

ARGENTINA

Texas Instruments Argentina S.A.I.C.F.
(P. O. Box 2296 — Correo Central)
Ruta Panamericana Km. 13, 5
Don Torcuato
Buenos Aires, Argentina

BRAZIL

Texas Instrumentos Electronicos
do Brazil Ltda.
Rua Cesario Alvim 770
Caixa Postal 30.103
Sao Paulo 6, Brazil

AUSTRALIA

Texas Instruments Australia Ltd.
Box 63, Oldham Road
Elizabeth, South Australia

Texas Instruments Australia Ltd.
Room 5, Rural Bank Bldg.
Burwood, N.S.W., Australia

JAPAN

Texas Instruments Asia Limited
404 T.B.R. Building
No. 59, 2-chome, Nagata-cho
Chiyoda-ku, Tokyo, Japan

TYPES 2N2483, 2N2484 N-P-N PLANAR SILICON TRANSISTORS



- FOR LOW-LEVEL, LOW-NOISE,
HIGH-GAIN, AMPLIFIER APPLICATIONS**
- **Guaranteed Low-Noise Characteristics at 100 Hz, 1 kHz, and 10 kHz**
 - **High $V_{(BR)CEO} \dots 60 \text{ V Min}$**
 - **D-C Beta Guaranteed at $I_c = 1 \mu\text{A}$ (2N2484)**

TYPES 2N2483, 2N2484
BULLETIN NO. DLS-6710300, SEPTEMBER 1967
REPLACES BULLETIN NO. DLS-645729, REVISED OCTOBER 1965

***mechanical data**

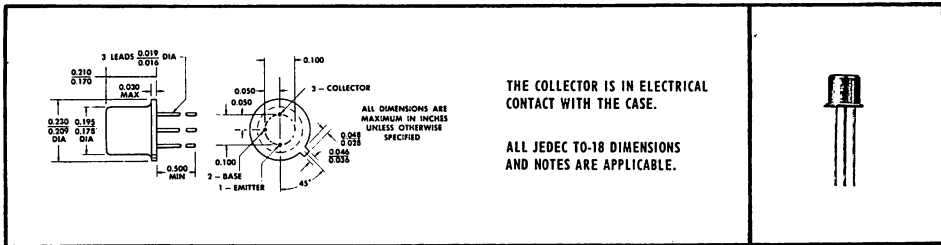

***absolute maximum ratings at 25°C free-air temperature (unless otherwise noted)**

Collector-Base Voltage	60 V
Collector-Emitter Voltage (See Note 1)	60 V
Emitter-Base Voltage	6 V
Continuous Collector Current	50 mA
Continuous Device Dissipation at (or below) 25°C Free-Air Temperature (See Note 2)	0.36 W
Continuous Device Dissipation at (or below) 25°C Case Temperature (See Note 3)	1.2 W
Continuous Device Dissipation at 100°C Case Temperature	0.68 W
Storage Temperature Range	-65°C to 200°C
Lead Temperature 1/16 Inch from Case for 10 Seconds	300°C

- NOTES: 1. This value applies when the base-emitter diode is open-circuited.
 2. Derate linearly to 200°C free-air temperature at the rate of 2.06 mW/deg.
 3. Derate linearly to 200°C case temperature at the rate of 6.85 mW/deg.

*Indicates JEDEC registered data

TYPES 2N2483, 2N2484

N-P-N PLANAR SILICON TRANSISTORS

*electrical characteristics at 25°C free-air temperature (unless otherwise noted)

PARAMETER	TEST CONDITIONS	2N2483		2N2484		UNIT
		MIN	MAX	MIN	MAX	
$V_{(BR)CBO}$ Collector-Base Breakdown Voltage	$I_C = 10 \mu A, I_E = 0$	60		60		V
$V_{(BR)CEO}$ Collector-Emitter Breakdown Voltage	$I_C = 10 mA, I_B = 0, \text{ See Note 4}$	60		60		V
$V_{(BR)EBO}$ Emitter-Base Breakdown Voltage	$I_E = 10 \mu A, I_C = 0$	6		6		V
I_{CBO} Collector Cutoff Current	$V_{CB} = 45 V, I_E = 0$		10		10	nA
	$V_{CB} = 45 V, I_E = 0, T_A = 150^\circ C$		10		10	μA
I_{EBO} Emitter Cutoff Current	$V_{EB} = 5 V, I_C = 0$		10		10	nA
h_{FE} Static Forward Current Transfer Ratio	$V_{CE} = 5 V, I_C = 1 \mu A$			30		
	$V_{CE} = 5 V, I_C = 10 \mu A$	40	120	100	500	
	$V_{CE} = 5 V, I_C = 10 \mu A, T_A = -55^\circ C$	10		20		
	$V_{CE} = 5 V, I_C = 100 \mu A$	75		175		
	$V_{CE} = 5 V, I_C = 500 \mu A$	100		200		
	$V_{CE} = 5 V, I_C = 1 mA$	175		250		
V_{BE} Base-Emitter Voltage	$V_{CE} = 5 V, I_C = 100 \mu A$	0.5	0.7	0.5	0.7	V
$V_{CE(sat)}$ Collector-Emitter Saturation Voltage	$I_B = 100 \mu A, I_C = 1 mA$		0.35		0.35	V
h_{io} Small-Signal Common-Emitter Input Impedance	$V_{CE} = 5 V, I_C = 1 mA, f = 1 kHz$	1.5	13	3.5	24	k Ω
h_{fo} Small-Signal Common-Emitter Forward Current Transfer Ratio		80	450	150	900	
h_{ro} Small-Signal Common-Emitter Reverse Voltage Transfer Ratio			8×10^{-4}		8×10^{-4}	
h_{oo} Small-Signal Common-Emitter Output Admittance			30		40	μmho
$ h_{fe} $ Small-Signal Common-Emitter Forward Current Transfer Ratio	$V_{CE} = 5 V, I_C = 50 \mu A, f = 5 MHz$	2.4		3		
	$V_{CE} = 5 V, I_C = 500 \mu A, f = 30 MHz$	2		2		
C_{obo} Common-Base Open-Circuit Output Capacitance	$V_{CB} = 5 V, I_E = 0, f = 140 kHz$		6		6	pF
C_{ibo} Common-Base Open-Circuit Input Capacitance	$V_{EB} = 0.5 V, I_C = 0, f = 140 kHz$		6		6	pF

*operating characteristics at 25°C free-air temperature

PARAMETER	TEST CONDITIONS	2N2483	2N2484	UNIT
		MAX	MAX	
\overline{NF} Average Noise Figure	$V_{CE} = 5 V, I_C = 10 \mu A, R_G = 10 k\Omega, \text{ Noise Bandwidth} = 15.7 kHz, \text{ See Note 5}$	4	3	dB
NF Spot Noise Figure	$V_{CE} = 5 V, I_C = 10 \mu A, R_G = 10 k\Omega, f = 100 Hz, \text{ Noise Bandwidth} = 20 Hz$	15	10	dB
	$V_{CE} = 5 V, I_C = 10 \mu A, R_G = 10 k\Omega, f = 1 kHz, \text{ Noise Bandwidth} = 200 Hz$	4	3	dB
	$V_{CE} = 5 V, I_C = 10 \mu A, R_G = 10 k\Omega, f = 10 kHz, \text{ Noise Bandwidth} = 2 kHz$	3	2	dB

NOTES: 4. These parameters must be measured using pulse techniques. $t_p = 300 \mu s, \text{ duty cycle} \leq 1\%$.

5. Average Noise Figure is measured in an amplifier with response down 3 dB at 10 Hz and 10 kHz and a high-frequency rolloff at 6 dB/octave.

*Indicates JEDEC registered data

TYPES 2N2483, 2N2484 N-P-N PLANAR SILICON TRANSISTORS

TYPICAL CHARACTERISTICS

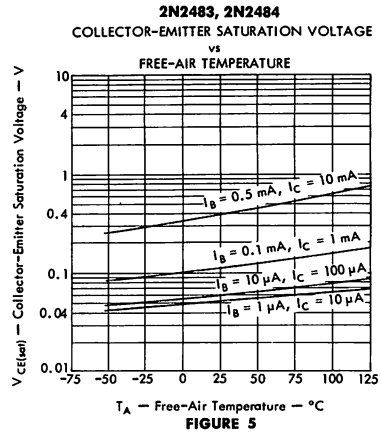
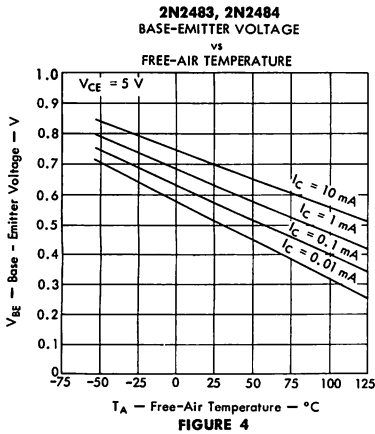
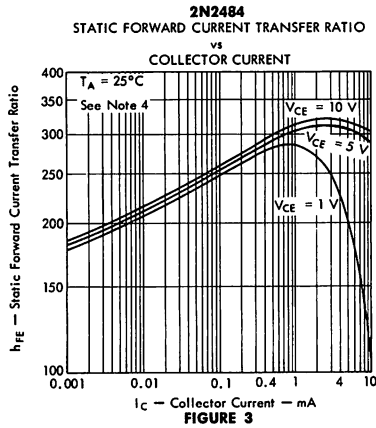
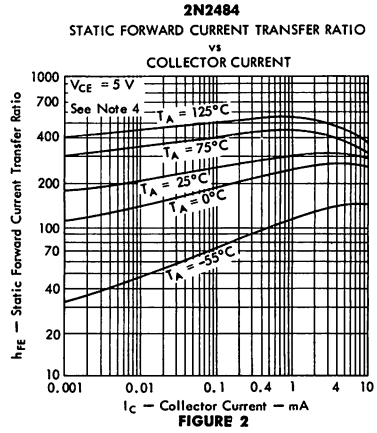
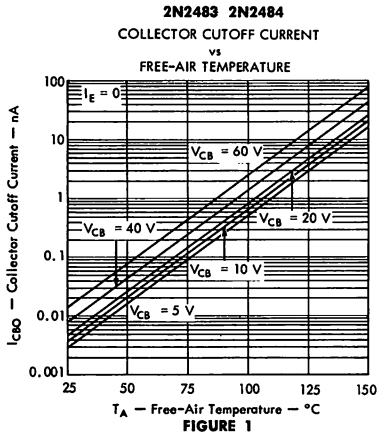

TYPES 2N2483, 2N2484 N-P-N PLANAR SILICON TRANSISTORS

TYPICAL CHARACTERISTICS

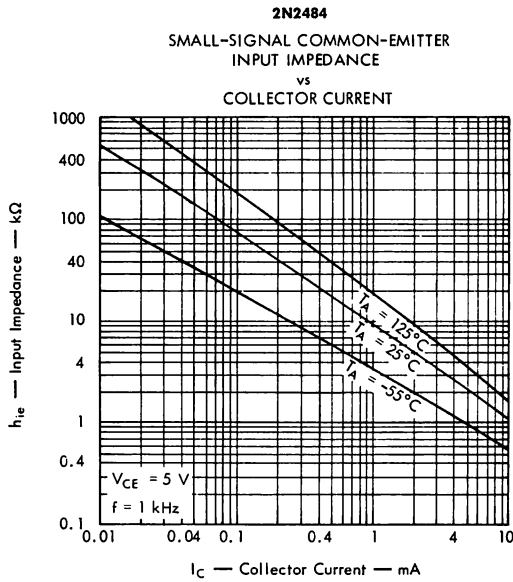

FIGURE 6

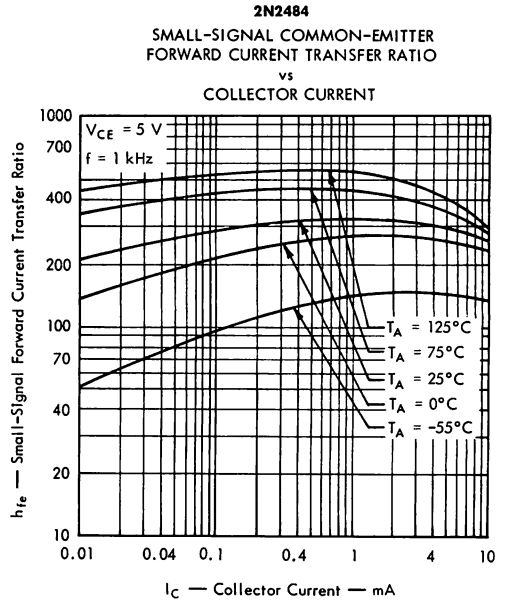

FIGURE 7

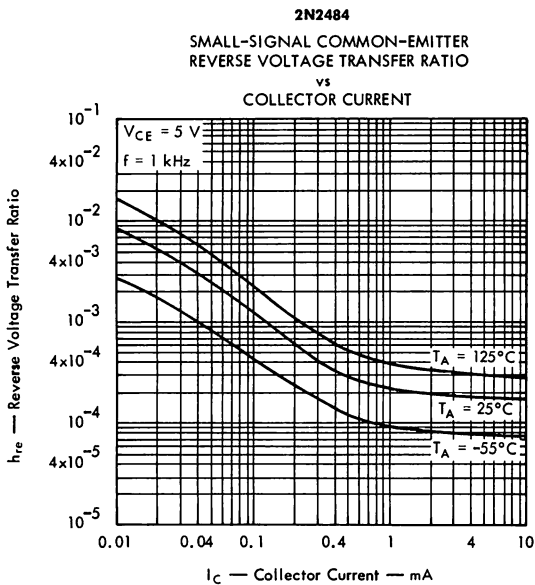

FIGURE 8

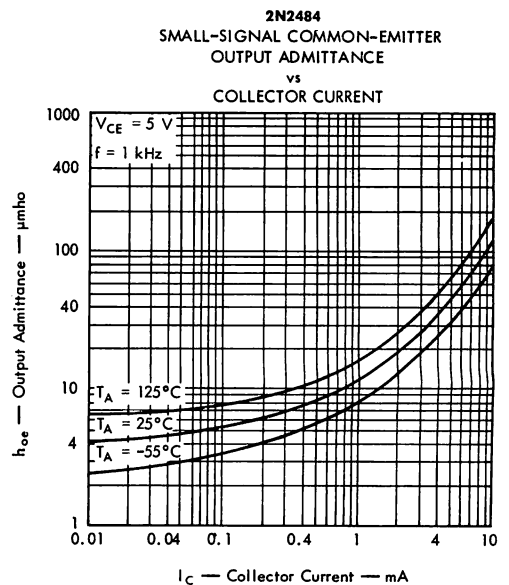
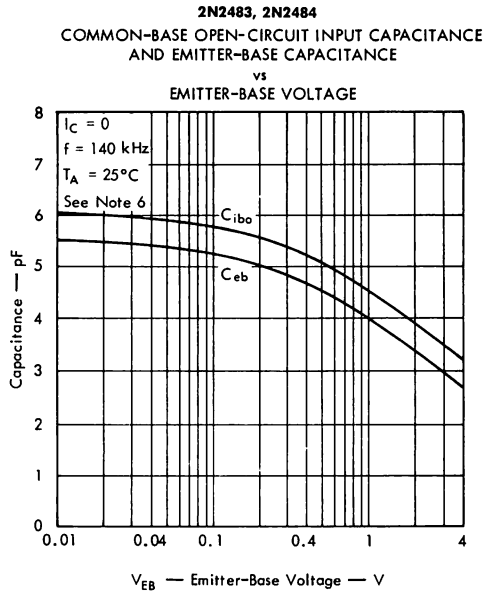
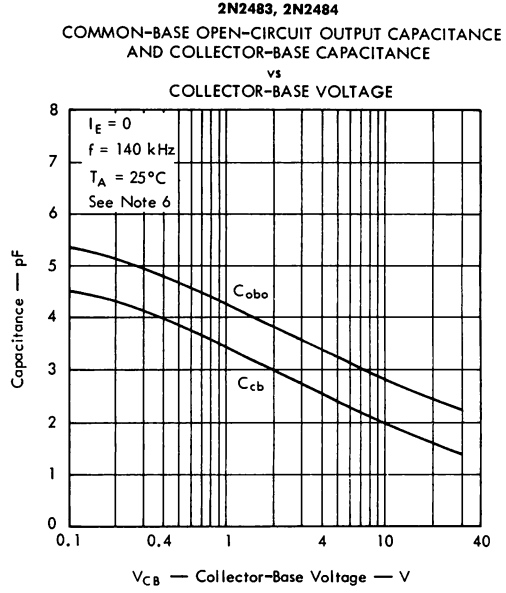
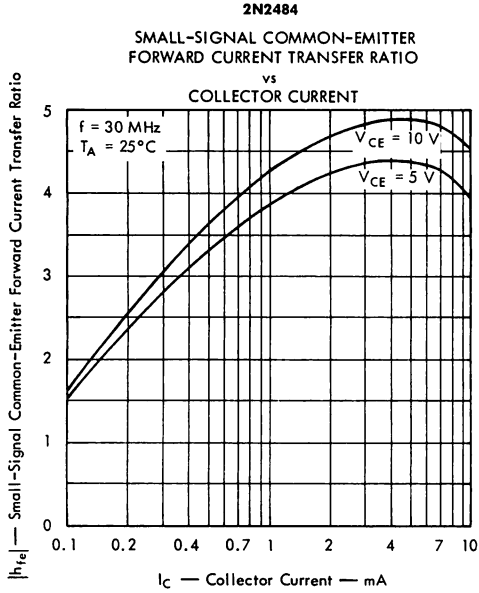

FIGURE 9

TYPES 2N2483, 2N2484 N-P-N PLANAR SILICON TRANSISTORS

TYPICAL CHARACTERISTICS



NOTE 6: C_{cb} and C_{ob} are measured using three-terminal measurement techniques with the third electrode (emitter or collector respectively) guarded. C_{obo} and C_{ibo} are measured with the third terminal floating.

TYPES 2N2483, 2N2484 N-P-N PLANAR SILICON TRANSISTORS

TYPICAL CHARACTERISTICS

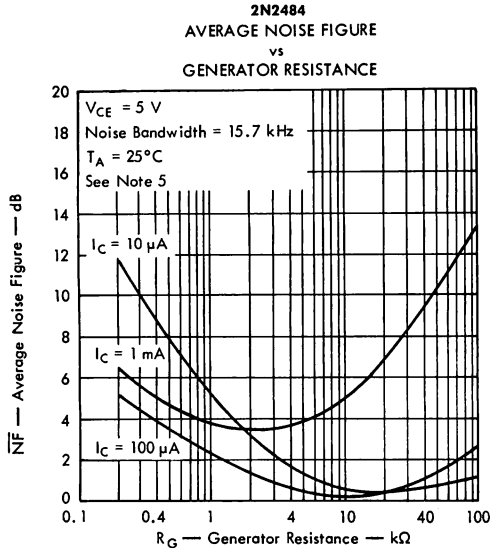

FIGURE 13

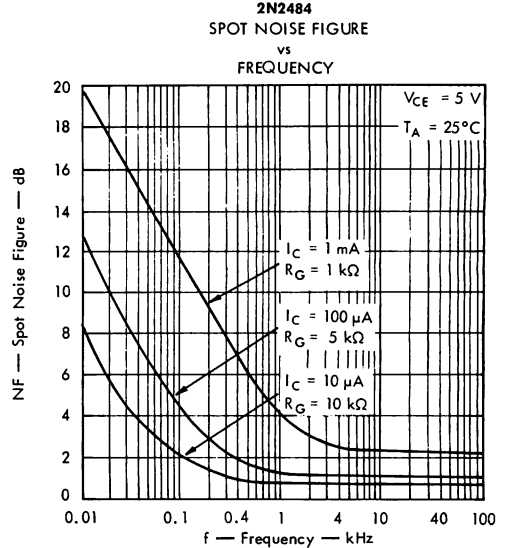

FIGURE 14

NOTE 5: Average Noise Figure is measured in an amplifier with response down 3 dB at 10 Hz and 10 kHz and a high-frequency rolloff at 6 dB/octave.

THERMAL INFORMATION

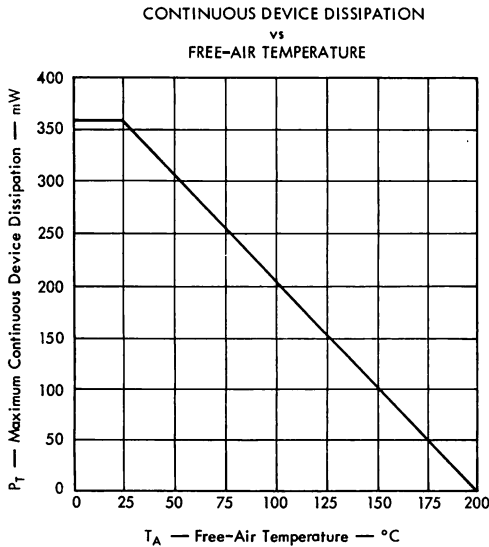

FIGURE 15

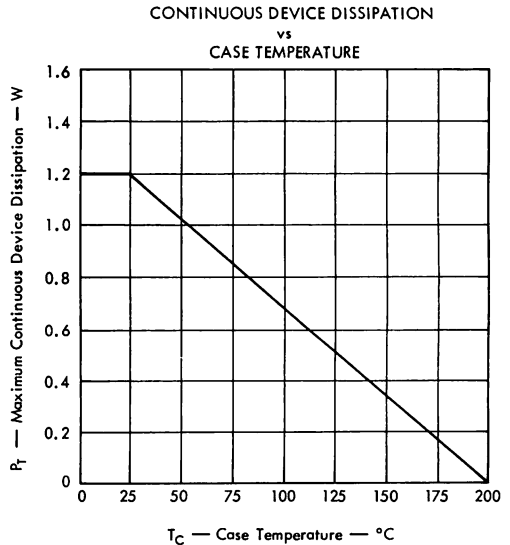

FIGURE 16

TYPE 2N3010 N-P-N EPITAXIAL PLANAR SILICON TRANSISTOR



DESIGNED FOR EXTREMELY HIGH-SPEED SWITCHING APPLICATIONS

TYPE 2N3010
BULLETIN NO. DL-5 645022, MARCH 1964

***mechanical data**

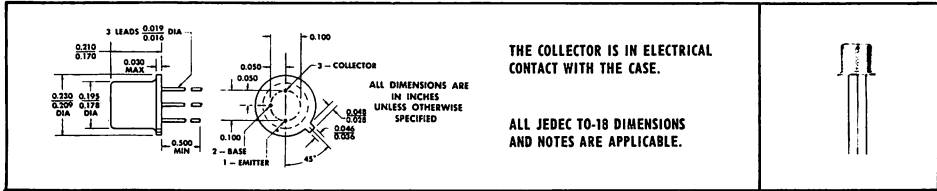

***absolute maximum ratings at 25°C free-air temperature (unless otherwise noted)**

Collector-Base Voltage	15 v
Collector-Emitter Voltage (See Note 1)	11 v
Collector-Emitter Voltage (See Note 2)	6 v
Emitter-Base Voltage	4 v
Collector Current	50 ma
Total Device Dissipation at (or below) 25°C Free-Air Temperature (See Note 3)	0.3 w
Operating Collector Junction Temperature	200°C
Storage Temperature Range	-65°C to +200°C

***electrical characteristics at 25°C free-air temperature (unless otherwise noted)**

PARAMETER		TEST CONDITIONS	MIN	MAX	UNIT
BV_{CBO}	Collector-Base Breakdown Voltage	$I_C = 10 \mu a, I_E = 0$	15		v
BV_{CEO}	Collector-Emitter Breakdown Voltage	$I_C = 10 \text{ ma}, I_B = 0, \text{ See Note 4}$	6		v
BV_{CES}	Collector-Emitter Breakdown Voltage	$I_C = 10 \mu a, V_{BE} = 0$	11		v
BV_{EBO}	Emitter-Base Breakdown Voltage	$I_E = 10 \mu a, I_C = 0$	4		v
I_{CES}	Collector Cutoff Current	$V_{CE} = 11 \text{ v}, V_{BE} = 0$		10	μa
		$V_{CE} = 5 \text{ v}, V_{BE} = 0$		100	na
		$V_{CE} = 5 \text{ v}, V_{BE} = 0, T_A = 85^\circ C$		5	μa
I_B	Base Current	$V_{CE} = 11 \text{ v}, V_{BE} = 0$		-10	μa
h_{FE}	Static Forward Current Transfer Ratio	$V_{CE} = 0.4 \text{ v}, I_C = 1 \text{ ma}, \text{ See Note 4}$	15		
		$V_{CE} = 0.4 \text{ v}, I_C = 10 \text{ ma}, \text{ See Note 4}$	25	125	
		$V_{CE} = 0.4 \text{ v}, I_C = 30 \text{ ma}, \text{ See Note 4}$	15		
V_{BE}	Base-Emitter Voltage	$I_B = 0.1 \text{ ma}, I_C = 1 \text{ ma}, \text{ See Note 4}$	0.68	0.85	v
		$I_B = 1 \text{ ma}, I_C = 10 \text{ ma}, \text{ See Note 4}$	0.75	0.95	v
		$I_B = 3 \text{ ma}, I_C = 30 \text{ ma}, \text{ See Note 4}$		1.30	v
		$I_B = 0.1 \text{ ma}, I_C = 1 \text{ ma}, \text{ See Note 4}$		0.25	v
$V_{CE(sat)}$	Collector-Emitter Saturation Voltage	$I_B = 1 \text{ ma}, I_C = 10 \text{ ma}, \text{ See Note 4}$		0.25	v
		$I_B = 3 \text{ ma}, I_C = 30 \text{ ma}, \text{ See Note 4}$		0.38	v
		$I_B = 1 \text{ ma}, I_C = 10 \text{ ma}, T_A = 85^\circ C, \text{ See Note 4}$		0.40	v
		$I_B = 0.1 \text{ ma}, I_C = 1 \text{ ma}, \text{ See Note 4}$		0.25	v
$ h_{fo} $	Small-Signal Common-Emitter Forward Current Transfer Ratio	$V_{CE} = 4 \text{ v}, I_C = 10 \text{ ma}, f = 100 \text{ Mc}$	6.0		
C_{ob}	Common-Base Open-Circuit Output Capacitance	$V_{CB} = 5 \text{ v}, I_E = 0, f = 140 \text{ kc}$		3.0	pf
C_{ib}	Common-Base Open-Circuit Input Capacitance	$V_{EB} = 0.5 \text{ v}, I_C = 0, f = 140 \text{ kc}$		2.0	pf

- NOTES: 1. This value applies when the base-emitter diode is short-circuited.
 2. This value applies between 10 μa and 10 ma collector current when the base-emitter diode is open-circuited.
 3. Derate linearly to 200°C free-air temperature at the rate of 1.71 mw/°C.
 4. These parameters must be measured using pulse techniques. PW = 300 μsec , Duty Cycle $\leq 2\%$.

*Indicates JEDEC registered data.



TEXAS INSTRUMENTS
INCORPORATED
POST OFFICE BOX 5012 • DALLAS, TEXAS 75222

TYPE 2N3010 N-P-N EPITAXIAL PLANAR SILICON TRANSISTOR

*switching characteristics at 25°C free-air temperature

PARAMETER	TEST CONDITIONS†	MAX	UNIT
t_{on} Turn-on Time	$I_C = 10 \text{ ma}$, $I_{B(1)} = 2 \text{ ma}$, $V_{BE(off)} = -1 \text{ v}$, $R_L = 84 \Omega$, See Figure 1	12	nsec
t_{off} Turn-off Time	$I_C = 10 \text{ ma}$, $I_{B(1)} = 1 \text{ ma}$, $I_{B(2)} = -1 \text{ ma}$, $R_L = 84 \Omega$, See Figure 1	12	nsec
t_s Storage Time	$I_C = 6 \text{ ma}$, $I_{B(1)} = 5 \text{ ma}$, $I_{B(2)} = -5 \text{ ma}$, See Figure 2	6	nsec

†Voltage and current values shown are nominal; exact values vary slightly with transistor parameters.

*PARAMETER MEASUREMENT INFORMATION

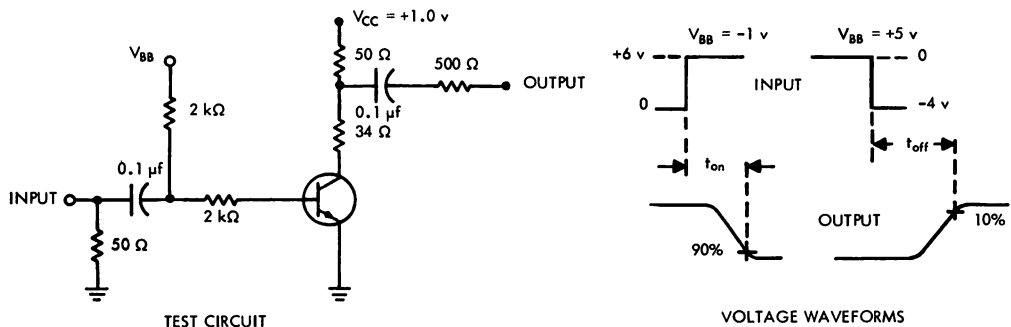

FIGURE 1 — TURN-ON AND TURN-OFF TIMES

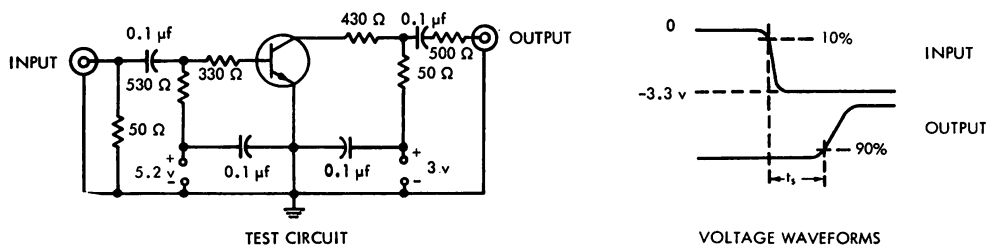

FIGURE 2 — STORAGE TIMES

NOTES: a. The input waveforms are supplied by a pulse generator with the following characteristics: $Z_{out} = 50 \Omega$, $t_r \leq 1 \text{ nsec}$, $PW \geq 100 \text{ nsec}$.

b. Output waveforms are monitored on an oscilloscope with the following characteristics: $t_r \leq 0.4 \text{ nsec}$, $Z_{in} = 50 \Omega$.

*Indicates JEDEC registered data.

TYPE 2N3013 N-P-N EPITAXIAL PLANAR SILICON TRANSISTOR



DESIGNED FOR VERY-HIGH-SPEED, HIGH-CURRENT SWITCHING APPLICATIONS

***mechanical data**

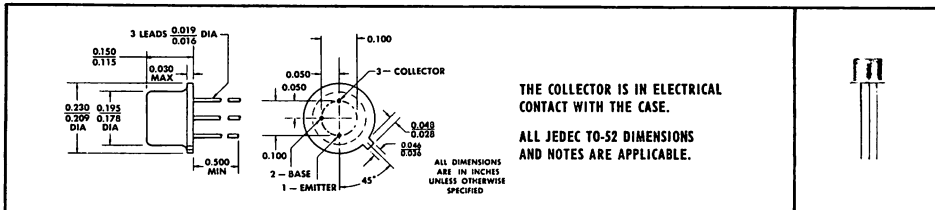

TYPE 2N3013
BULLETIN NO. DLS 645019, MARCH 1964

***absolute maximum ratings at 25°C free-air temperature (unless otherwise noted)**

Collector-Base Voltage	40 v
Collector-Emitter Voltage (See Note 1)	40 v
Collector-Emitter Voltage (See Note 2)	15 v
Emitter-Base Voltage	5 v
Collector Current, Continuous	200 ma
Collector Current, Peak (See Note 3)	500 ma
Total Device Dissipation at (or below) 25°C Free-Air Temperature (See Note 4)	0.36 w
Total Device Dissipation at (or below) 25°C Case Temperature (See Note 5)	1.2 w
Total Device Dissipation at 100°C Case Temperature	0.68 w
Operating Collector Junction Temperature	200°C
Storage Temperature Range	-65°C to +200°C

***electrical characteristics at 25°C free-air temperature (unless otherwise noted)**

PARAMETER		TEST CONDITIONS	MIN	MAX	UNIT
BV_{CBO}	Collector-Base Breakdown Voltage	$I_C = 100 \mu A, I_E = 0$	40		v
BV_{CEO}	Collector-Emitter Breakdown Voltage	$I_C = 10 \text{ ma}, I_B = 0, \text{ See Note 6}$	15		v
BV_{CES}	Collector-Emitter Breakdown Voltage	$I_C = 100 \mu A, V_{BE} = 0$	40		v
BV_{EBO}	Emitter-Base Breakdown Voltage	$I_E = 100 \mu A, I_C = 0$	5		v
I_{CES}	Collector Cutoff Current	$V_{CE} = 20 \text{ v}, V_{BE} = 0$		0.3	μA
		$V_{CE} = 20 \text{ v}, V_{BE} = 0, T_A = 125^\circ C$		40	μA
I_B	Base Current	$V_{CE} = 20 \text{ v}, V_{BE} = 0$	-0.3		μA
		$V_{CE} = 0.4 \text{ v}, I_C = 30 \text{ ma}, \text{ See Note 6}$	30	120	
		$V_{CE} = 0.5 \text{ v}, I_C = 100 \text{ ma}, \text{ See Note 6}$	25		
		$V_{CE} = 1 \text{ v}, I_C = 300 \text{ ma}, \text{ See Note 6}$	15		
V_{BE}	Base-Emitter Voltage	$I_B = 3 \text{ ma}, I_C = 30 \text{ ma}, \text{ See Note 6}$	0.75	0.95	v
		$I_B = 10 \text{ ma}, I_C = 100 \text{ ma}, \text{ See Note 6}$	1.20		v
		$I_B = 30 \text{ ma}, I_C = 300 \text{ ma}, \text{ See Note 6}$	1.70		v
		$I_B = 3 \text{ ma}, I_C = 30 \text{ ma}, \text{ See Note 6}$	0.18		v
$V_{CE(sat)}$	Collector-Emitter Saturation Voltage	$I_B = 10 \text{ ma}, I_C = 100 \text{ ma}, \text{ See Note 6}$	0.28		v
		$I_B = 30 \text{ ma}, I_C = 300 \text{ ma}, \text{ See Note 6}$	0.50		v
		$I_B = 3 \text{ ma}, I_C = 30 \text{ ma}, T_A = 125^\circ C, \text{ See Note 6}$	0.25		v
		$V_{CE} = 10 \text{ v}, I_C = 30 \text{ ma}, f = 100 \text{ Mc}$	3.5		
C_{ob}	Common-Base Open-Circuit Output Capacitance	$V_{CB} = 5 \text{ v}, I_E = 0, f = 140 \text{ kc}$	5.0		pf
C_{ib}	Common-Base Open-Circuit Input Capacitance	$V_{EB} = 0.5 \text{ v}, I_C = 0, f = 140 \text{ kc}$	8.0		pf

- NOTES: 1. This value applies when the base-emitter diode is short-circuited.
 2. This value applies between 10 μA and 10 ma collector current when the base-emitter diode is open-circuited.
 3. This value applies for $PW \leq 10 \mu sec$.

4. Derate linearly to 200°C free-air temperature at the rate of 2.06 mw/°C.
 5. Derate linearly to 200°C case temperature at the rate of 6.85 mw/°C.
 6. These parameters must be measured using pulse techniques. $PW = 300 \mu sec$, Duty Cycle $\leq 2\%$.

*Indicates JEDEC registered data.



TYPE 2N3013

N-P-N EPITAXIAL PLANAR SILICON TRANSISTOR

*switching characteristics at 25°C free-air temperature

PARAMETER	TEST CONDITIONS†	MAX	UNIT
t_{on} Turn-on Time	$I_C = 300 \text{ ma}$, $I_{B(1)} = 30 \text{ ma}$, $I_{B(2)} = -35 \text{ ma}$	15	nsec
t_{off} Turn-off Time	$V_{BE(off)} = -5 \text{ v}$, $R_L = 50 \Omega$, See Figure 1	25	nsec
t_s Storage Time	$I_C = I_{B(1)} = -I_{B(2)} = 10 \text{ ma}$, See Figure 2	18	nsec

†Voltage and current values shown are nominal; exact values vary slightly with transistor parameters.

*PARAMETER MEASUREMENT INFORMATION

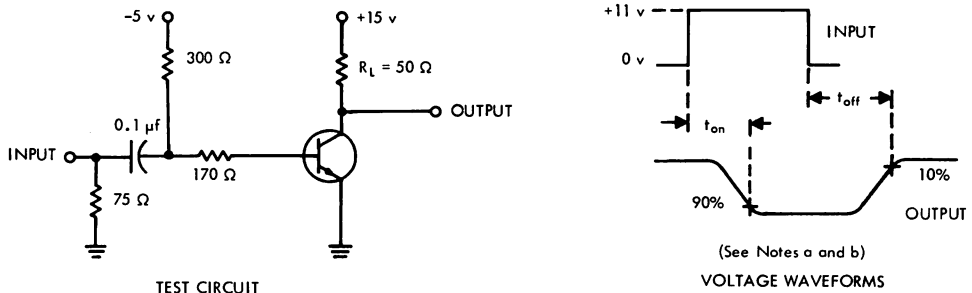

FIGURE 1 — TURN-ON AND TURN-OFF TIMES

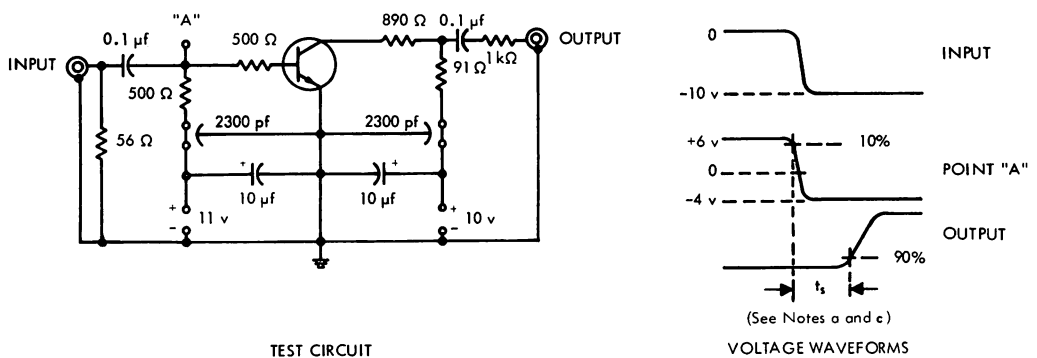

FIGURE 2 — STORAGE TIMES

- NOTES: a. The input waveforms are supplied by a pulse generator with the following characteristics: $Z_{out} = 50 \Omega$, $t_r \leq 1 \text{ nsec}$, $t_f \leq 1 \text{ nsec}$, $PW \geq 300 \text{ nsec}$, Duty Cycle $\leq 2\%$.
- b. Waveforms of figure 1 are monitored on an oscilloscope with the following characteristics: $t_r \leq 1 \text{ nsec}$, $R_{in} \geq 100 \text{ k}\Omega$.
- c. Output waveform of figure 2 is monitored on an oscilloscope with the following characteristics: $t_r \leq 1 \text{ nsec}$, $Z_{in} = 50\Omega$.

*Indicates JEDEC registered data.

TYPE 2N3015 N-P-N EPITAXIAL PLANAR SILICON TRANSISTOR



DESIGNED FOR HIGH-SPEED, HIGH-CURRENT SWITCHING APPLICATIONS

TYPE 2N3015
BULLETIN NO. D1-S 645017, MARCH 1964

***mechanical data**

THE COLLECTOR IS IN ELECTRICAL CONTACT WITH THE CASE.

ALL JEDEC TO-5 DIMENSIONS AND NOTES ARE APPLICABLE.

ALL DIMENSIONS ARE IN INCHES UNLESS OTHERWISE SPECIFIED

***absolute maximum ratings at 25°C free-air temperature (unless otherwise noted)**

Collector-Base Voltage	60 v
Collector-Emitter Voltage (See Note 1)	30 v
Emitter-Base Voltage	5 v
Total Device Dissipation at (or below) 25°C Free-Air Temperature (See Note 2)	0.8 w
Total Device Dissipation at (or below) 25°C Case Temperature (See Note 3)	3.0 w
Operating Collector Junction Temperature	200°C
Storage Temperature Range	-65°C to +200°C

***electrical characteristics at 25°C free-air temperature (unless otherwise noted)**

PARAMETER	TEST CONDITIONS	MIN	MAX	UNIT
V_{CB0} Collector-Base Breakdown Voltage	$I_C = 100 \mu A, I_E = 0$	60		v
V_{CEO} Collector-Emitter Breakdown Voltage	$I_C = 30 \text{ ma}, I_B = 0, \text{ See Note 4}$	30		v
V_{EBO} Emitter-Base Breakdown Voltage	$I_E = 100 \mu A, I_C = 0$	5		v
I_{CES} Collector Cutoff Current	$V_{CE} = 30 \text{ v}, V_{BE} = 0$		0.2	μA
I_{CBO} Collector Cutoff Current	$V_{CB} = 30 \text{ v}, I_E = 0, T_A = 125^\circ C$		200	μA
I_B Base Current	$V_{CE} = 20 \text{ v}, V_{BE} = 0$		-0.2	μA
h_{FE} Static Forward Current Transfer Ratio	$V_{CE} = 10 \text{ v}, I_C = 150 \text{ ma}, \text{ See Note 4}$	30	120	
	$V_{CE} = 0.7 \text{ v}, I_C = 300 \text{ ma}, \text{ See Note 4}$	10		
V_{BE} Base-Emitter Voltage	$I_B = 15 \text{ ma}, I_C = 150 \text{ ma}, \text{ See Note 4}$		1.2	v
	$I_B = 50 \text{ ma}, I_C = 500 \text{ ma}, \text{ See Note 4}$		1.6	v
$V_{CE(sat)}$ Collector-Emitter Saturation Voltage	$I_B = 15 \text{ ma}, I_C = 150 \text{ ma}, \text{ See Note 4}$		0.4	v
	$I_B = 50 \text{ ma}, I_C = 500 \text{ ma}, \text{ See Note 4}$		1.0	v
$ h_{fe} $ Small-Signal Common-Emitter Forward Current Transfer Ratio	$V_{CE} = 10 \text{ v}, I_C = 50 \text{ ma}, f = 100 \text{ Mc}$	2.5		
C_{ob} Common-Base Open-Circuit Output Capacitance	$V_{CB} = 10 \text{ v}, I_E = 0, f = 140 \text{ kc}$		8.0	pf

- NOTES: 1. This value applies between 1 ma and 30 ma collector current when the base-emitter diode is open-circuited.
 2. Derate linearly to 200°C free-air temperature at the rate of 4.6 mw/°C.
 3. Derate linearly to 200°C case temperature at the rate of 17.2 mw/°C.
 4. These parameters must be measured using pulse techniques. PW = 300 μ sec, Duty Cycle \leq 2%.

*Indicates JEDEC registered data.

TYPE 2N3015

N-P-N EPITAXIAL PLANAR SILICON TRANSISTOR

*switching characteristics at 25°C free-air temperature

PARAMETER	TEST CONDITIONS†	MAX	UNIT
t_{on} Turn-on Time	$I_C = 300 \text{ ma}$, $I_{B(1)} = 30 \text{ ma}$, $V_{BE(off)} = 0$, $R_L = 80 \Omega$, See Figure 1	40	nsec
	$I_C = 500 \text{ ma}$, $I_{B(1)} = 50 \text{ ma}$, $V_{BE(off)} = 0$, $R_L = 48 \Omega$, See Figure 1	40	nsec
t_{off} Turn-off Time	$I_C = 300 \text{ ma}$, $I_{B(1)} = 30 \text{ ma}$, $I_{B(2)} = -35 \text{ ma}$, $R_L = 80 \Omega$, See Figure 2	60	nsec
	$I_C = 500 \text{ ma}$, $I_{B(1)} = 50 \text{ ma}$, $I_{B(2)} = -55 \text{ ma}$, $R_L = 48 \Omega$, See Figure 2	60	nsec

†Voltage and current values shown are nominal; exact values vary slightly with transistor parameters.

*PARAMETER MEASUREMENT INFORMATION

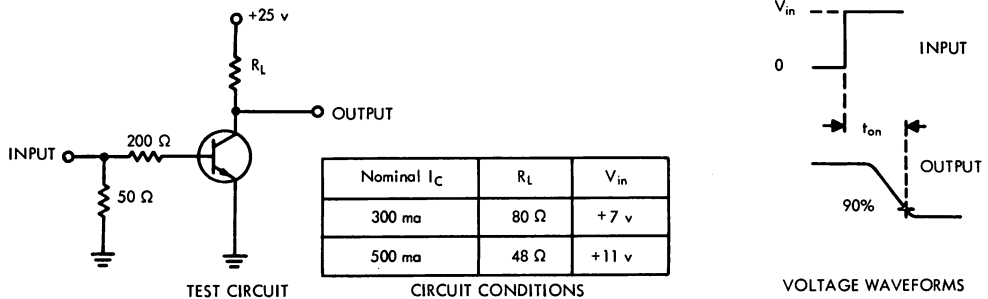

FIGURE 1 — TURN-ON TIMES

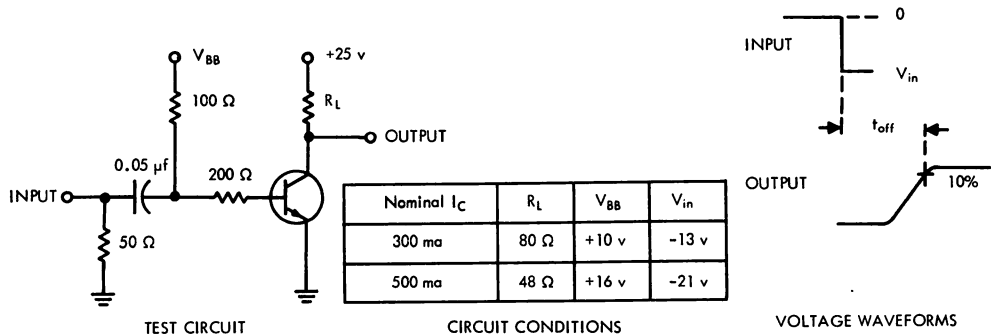

FIGURE 2 — TURN-OFF TIMES

NOTES: a. The input waveforms are supplied by a pulse generator with the following characteristics: $Z_{out} = 50 \Omega$, $t_r \leq 2 \text{ nsec}$, $PW = 200 \text{ nsec}$.
 b. Waveforms are monitored on an oscilloscope with the following characteristics: $t_r \leq 1 \text{ nsec}$, $R_{in} \geq 100 \text{ k}\Omega$.

*Indicates JEDEC registered data.

TYPES 2N3707, 2N3708, 2N3709, 2N3710, 2N3711 N-P-N PLANAR SILICON TRANSISTORS



TYPES 2N3707, 2N3708, 2N3709, 2N3710, 2N3711
BULLETIN NO. DL-5 687584, APRIL 1965
REPLACES BULLETIN NO. DL-5 657334, FEBRUARY 1965
REVISED JANUARY 1968

SILECT† TRANSISTORS

- ENCAPSULATED IN PLASTIC
- INSENSITIVE TO LIGHT
- HIGHLY MOISTURE RESISTANT

2N3707 (Formerly TI415) For Low-Level, Low-Noise Applications
 2N3708 (Formerly TI416) }
 2N3709 } For General-Purpose, Low-Level, High-Gain Applications
 2N3710 (Formerly TI417) }
 2N3711 (Formerly TI418) }

mechanical data

These transistors are encapsulated in a plastic compound specifically designed for this purpose, using a highly mechanized process‡ developed by Texas Instruments. The case will withstand soldering temperatures without deformation. These devices exhibit stable characteristics under high-humidity conditions and are capable of meeting MIL-STD-202C method 106B. The transistors are insensitive to light.

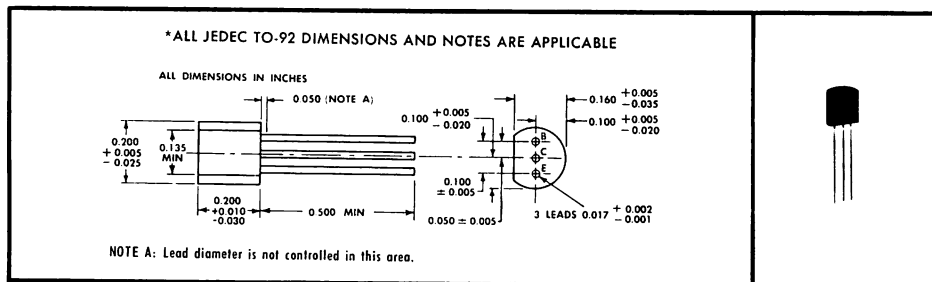

*absolute maximum ratings at 25°C free-air temperature (unless otherwise noted)

Collector-Base Voltage	30 v
Collector-Emitter Voltage (See Note 1)	30 v
Emitter-Base Voltage	6 v
Collector Current	30 ma
Continuous Device Dissipation at (or below) 25°C Free-Air Temperature (See Note 2)	360 mw
Storage Temperature Range	-65°C to 150°C
Lead Temperature 1/8 Inch from Case for 10 Seconds	260°C

NOTES: 1. This value applies when the base-emitter diode is open-circuited.
 2. Derate linearly to 150°C free-air temperature at the rate of 2.88 mw/C°.

*Indicates JEDEC registered data (typical data excluded).

†Trademark of Texas Instruments Incorporated

‡Patent Pending



TEXAS INSTRUMENTS
INCORPORATED
POST OFFICE BOX 5012 • DALLAS, TEXAS 75222

TYPES 2N3707, 2N3708, 2N3709, 2N3710, 2N3711

N-P-N PLANAR SILICON TRANSISTORS

*electrical characteristics at 25°C free-air temperature

PARAMETER	TEST CONDITIONS	2N3707		2N3708		2N3709		2N3710		2N3711		UNIT
		MIN	MAX	MIN	MAX	MIN	MAX	MIN	MAX	MIN	MAX	
$V_{(BR)CEO}$ Collector-Emitter Breakdown Voltage	$I_C = 1 \text{ ma}, I_B = 0$	30		30		30		30		30		v
I_{CBO} Collector Cutoff Current	$V_{CB} = 20 \text{ v}, I_E = 0$	100		100		100		100		100		na
I_{EBO} Emitter Cutoff Current	$V_{EB} = 6 \text{ v}, I_C = 0$	100		100		100		100		100		na
h_{FE} Static Forward Current Transfer Ratio	$V_{CE} = 5 \text{ v}, I_C = 100 \mu\text{a}$	100	400									
	$V_{CE} = 5 \text{ v}, I_C = 1 \text{ ma}$			45	660	45	165	90	330	180	660	
V_{BE} Base-Emitter Voltage	$V_{CE} = 5 \text{ v}, I_C = 1 \text{ ma}$	0.5	1	0.5	1	0.5	1	0.5	1	0.5	1	v
$V_{CE(sat)}$ Collector-Emitter Saturation Voltage	$I_B = 0.5 \text{ ma}, I_C = 10 \text{ ma}$	1		1		1		1		1		v
h_{fo} Small-Signal Common-Emitter Forward Current Transfer Ratio	$V_{CE} = 5 \text{ v}, I_C = 100 \mu\text{a}, f = 1 \text{ kc}$	100	550									
	$V_{CE} = 5 \text{ v}, I_C = 1 \text{ ma}, f = 1 \text{ kc}$			45	800	45	250	90	450	180	800	

*operating characteristics at 25°C free-air temperature

PARAMETER	TEST CONDITIONS	2N3707		UNIT
		TYP	MAX	
\overline{NF} Average Noise Figure	$V_{CE} = 5 \text{ v}, I_C = 100 \mu\text{a}, R_G = 5 \text{ k}\Omega, \text{ Noise Bandwidth} = 15.7 \text{ kc}, \text{ See Note 3}$	1.9	5	db

NOTE 3: Average Noise Figure is measured in an amplifier with low-frequency response down 3 db at 10 cps.

*Indicates JEDEC registered data (typical data excluded).

PARAMETER DISTRIBUTION INFORMATION

The 2N3708 is furnished in seven color-coded h_{FE} brackets, each having less than 2-to-1 spread. In lots of 1000 (or more) pieces they are shipped in the percentages shown below.

COLOR CODE	h_{FE} BRACKET		CONTENT
	$V_{CE} = 5 \text{ v}, I_C = 1 \text{ ma}$		
brown	45-85		0-5%
red	65-110		5-15%
orange	90-165		25-35%
yellow	135-220		15-25%
green	180-330		15-25%
blue	270-440		0-10%
violet	360-660		0-5%

Table 1 — 2N3708 h_{FE} DISTRIBUTION

TYPES 2N3724, 2N3724A, 2N3725, 2N3725A N-P-N EPITAXIAL PLANAR SILICON TRANSISTORS



FAST, HIGH-VOLTAGE, HIGH-CURRENT CORE DRIVERS

- h_{FE} Guaranteed from 10 mA to 1.5 A
- Made with TRI-REL[†] Redundant Stabilization (Field-Relief Electrode[‡], Special Oxide Passivation, Annular Guard Ring[§])
- Guaranteed Switching Times at One Ampere (2N3724A, 2N3725A)

*mechanical data

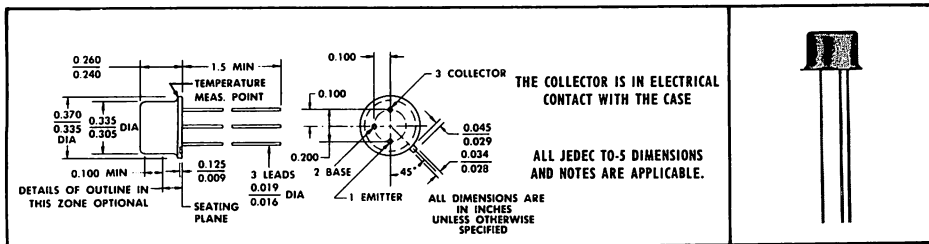

TYPES 2N3724, 2N3724A, 2N3725, 2N3725A
BULLETIN NO. DL-5 6710081, JUNE 1967
REPLACES BULLETIN NO. DL-5 679713, MARCH 1967
AND BULLETIN NO. DL-5 679871, JANUARY 1967

*absolute maximum ratings at 25°C free-air temperature (unless otherwise noted)

	2N3724	2N3724A	2N3725	2N3725A	UNIT
Collector-Base Voltage		50		80	V
Collector-Emitter Voltage (See Note 1)		30		50	V
Emitter-Base Voltage		6		6	V
Continuous Collector Current	0.5	1.2	0.5	1.2	A
Peak Collector Current (See Note 2)		1.75		1.75	A
Continuous Device Dissipation at (or below) 25°C Free-Air Temperature (See Note 3)	0.8	1	0.8	1	W
Continuous Device Dissipation at (or below) 25°C Case Temperature (See Note 4)	3.5	5	3.5	5	W
Storage Temperature Range	-65 to 200		-65 to 200		°C
Lead Temperature $\frac{1}{16}$ Inch from Case for 60 Seconds	300		300		°C

- NOTES: 1. These values apply between 0.01 mA and 500 mA collector current when the base-emitter diode is open-circuited.
2. This value applies for square-wave pulses. $t_p = 300 \mu s$, duty cycle $\leq 2\%$.
3. For the 2N3724 and 2N3725 derate linearly to 200°C free-air temperature at the rate of 4.6 mW/deg. For the 2N3724A and 2N3725A derate linearly to 200°C free-air temperature at the rate of 5.71 mW/deg.
4. For the 2N3724 and 2N3725 derate linearly to 200°C case temperature at the rate of 20 mW/deg. For the 2N3724A and 2N3725A derate linearly to 200°C case temperature at the rate of 28.6 mW/deg.

†Trademark of Texas Instruments

‡Patent pending

§Patented by Texas Instruments

*Indicates JEDEC registered data



TEXAS INSTRUMENTS
INCORPORATED
POST OFFICE BOX 5012 • DALLAS, TEXAS 75222

TYPES 2N3724, 2N3724A, 2N3725, 2N3725A

N-P-N EPITAXIAL PLANAR SILICON TRANSISTORS

*electrical characteristics at 25°C free-air temperature (unless otherwise noted)

PARAMETER	TEST CONDITIONS	2N3724	2N3724A	2N3725	2N3725A	UNIT
		MIN MAX	MIN MAX	MIN MAX	MIN MAX	
$V_{(BR)CBO}$ Collector-Base Breakdown Voltage	$I_C = 10 \mu A, I_E = 0$	50	50	80	80	V
$V_{(BR)CEO}$ Collector-Emitter Breakdown Voltage	$I_C = 10 mA, I_B = 0$, See Note 5	30	30	50	50	V
$V_{(BR)CES}$ Collector-Emitter Breakdown Voltage	$I_C = 10 \mu A, V_{BE} = 0$	50	50	80	80	V
$V_{(BR)EBO}$ Emitter-Base Breakdown Voltage	$I_E = 10 \mu A, I_C = 0$	6	6	6	6	V
I_{CBO} Collector Cutoff Current	$V_{CB} = 40 V, I_E = 0$	1.7	0.5			μA
	$V_{CB} = 40 V, I_E = 0, T_A = 100^\circ C$	120	50			μA
	$V_{CB} = 60 V, I_E = 0$			1.7	0.5	μA
	$V_{CB} = 60 V, I_E = 0, T_A = 100^\circ C$			120	50	μA
I_{CES} Collector Cutoff Current	$V_{CE} = 50 V, V_{BE} = 0$	10	10			μA
	$V_{CE} = 80 V, V_{BE} = 0$			10	10	μA
I_B Base Current	$V_{CE} = 50 V, V_{BE} = 0$	-10	-10			μA
	$V_{CE} = 80 V, V_{BE} = 0$			-10	-10	μA
h_{FE} Static Forward Current Transfer Ratio	$V_{CE} = 1 V, I_C = 10 mA$	30	30	30	30	
	$V_{CE} = 1 V, I_C = 100 mA$	60 150	60 150	60 150	60 150	
	$V_{CE} = 1 V, I_C = 100 mA, T_A = -55^\circ C$	30	30	30	30	
	$V_{CE} = 1 V, I_C = 300 mA$	40	40	40	40	
	$V_{CE} = 1 V, I_C = 500 mA$	35	35	35	35	
	$V_{CE} = 1 V, I_C = 500 mA, T_A = -55^\circ C$	20	20	20	20	
	$V_{CE} = 2 V, I_C = 800 mA$	25	30	20	25	
	$V_{CE} = 5 V, I_C = 1 A$	30	30	25	25	
V_{BE} Base-Emitter Voltage	$I_B = 1 mA, I_C = 10 mA$	0.76	0.76	0.76	0.76	V
	$I_B = 10 mA, I_C = 100 mA$	0.86	0.86	0.86	0.86	V
	$I_B = 30 mA, I_C = 300 mA$	1.1	1.1	1.1	1.1	V
	$I_B = 50 mA, I_C = 500 mA$	0.9 1.2	0.9 1.2	0.9 1.2	0.9 1.2	V
	$I_B = 80 mA, I_C = 800 mA$	1.5	1.3	1.5	1.3	V
	$I_B = 100 mA, I_C = 1 A$	1.7	0.9 1.4	1.7	0.9 1.4	V
$V_{CE(sat)}$ Collector-Emitter Saturation Voltage	$I_B = 1 mA, I_C = 10 mA$	0.25	0.25	0.25	0.25	V
	$I_B = 10 mA, I_C = 100 mA$	0.2	0.2	0.26	0.26	V
	$I_B = 30 mA, I_C = 300 mA$	0.32	0.32	0.4	0.4	V
	$I_B = 50 mA, I_C = 500 mA$	0.42	0.42	0.52	0.52	V
	$I_B = 80 mA, I_C = 800 mA$	0.65	0.65	0.8	0.8	V
	$I_B = 100 mA, I_C = 1 A$	0.75	0.75	0.95	0.9	V
$ h_{fe} $ Small-Signal Common-Emitter Forward Current Transfer Ratio	$V_{CE} = 10 V, I_C = 50 mA, f = 100 MHz$	3	3	3	3	
C_{obo} Common-Base Open-Circuit Output Capacitance	$V_{CB} = 10 V, I_E = 0, f = 1 MHz$	12	12	10	10	pF
C_{ibo} Common-Base Open-Circuit Input Capacitance	$V_{EB} = 0.5 V, I_C = 0, f = 1 MHz$	55	55	55	55	pF

NOTE 5: These parameters must be measured using pulse techniques. $t_p = 300 \mu s$, duty cycle $\leq 1\%$.

*Indicates JEDEC registered data

TYPES 2N3724, 2N3724A, 2N3725, 2N3725A N-P-N EPITAXIAL PLANAR SILICON TRANSISTORS

*switching characteristics at 25°C free-air temperature

PARAMETER	TEST CONDITIONS†	2N3724	2N3724A	2N3725	2N3725A	UNIT
		MAX	MAX	MAX	MAX	
t_d Delay Time	$I_C = 500 \text{ mA}$,	10	10	10	10	ns
t_r Rise Time	$I_{B(1)} = 50 \text{ mA}$, $V_{BE(off)} = -3.8 \text{ V}$,	30	30	30	30	ns
t_{on} Turn-On Time	$R_L = 58 \Omega$, See Figure 1	35	35	35	35	ns
t_s Storage Time	$I_C = 500 \text{ mA}$,	50	50	50	50	ns
t_f Fall Time	$I_{B(1)} = 50 \text{ mA}$, $I_{B(2)} = -50 \text{ mA}$,	25	25	30	30	ns
t_{off} Turn-Off Time	$R_L = 58 \Omega$, See Figure 1	60	60	60	60	ns
t_{on} Turn-On Time	$I_C = 1 \text{ A}$, $I_{B(1)} = 100 \text{ mA}$, $V_{BE(off)} = -2 \text{ V}$, $R_L = 30 \Omega$, See Figure 2		30		30	ns
t_{off} Turn-Off Time	$I_C = 1 \text{ A}$, $I_{B(1)} = 100 \text{ mA}$, $I_{B(2)} = -100 \text{ mA}$, $R_L = 30 \Omega$, See Figure 3		50		50	ns

†Voltage and current values shown are nominal; exact values vary slightly with transistor parameters.

* PARAMETER MEASUREMENT INFORMATION

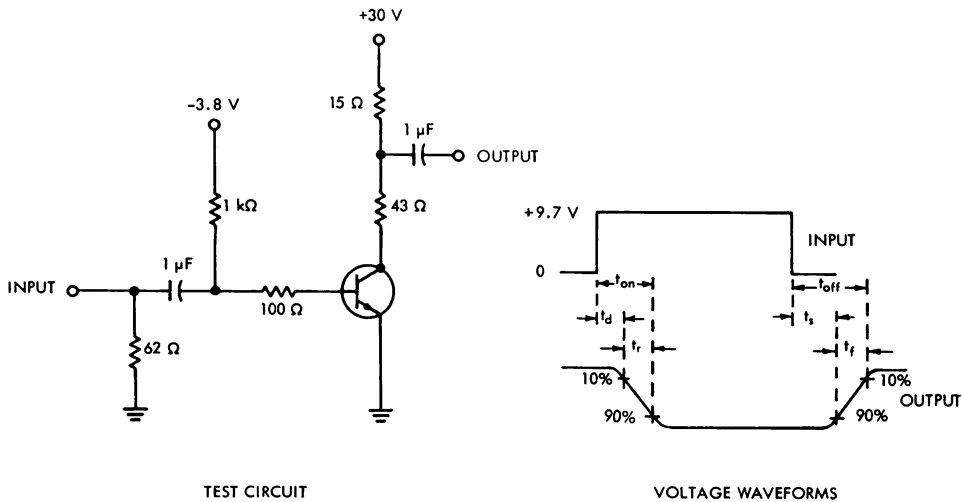

FIGURE 1 — 500-mA SWITCHING TIMES

NOTES: a. The input waveforms are supplied by a generator with the following characteristics: $Z_{out} = 50 \Omega$, $t_r \leq 1 \text{ ns}$, $t_f \leq 1 \text{ ns}$, $t_p \approx 1 \mu\text{s}$, duty cycle $\leq 2\%$.
b. The output waveforms are monitored on an oscilloscope with the following characteristics: $t_r \leq 1 \text{ ns}$, $R_{in} \geq 100 \text{ k}\Omega$, $C_{in} \leq 7 \text{ pF}$.

*Indicates JEDEC registered data

TYPES 2N3724, 2N3724A, 2N3725, 2N3725A N-P-N EPITAXIAL PLANAR SILICON TRANSISTORS

PARAMETER MEASUREMENT INFORMATION

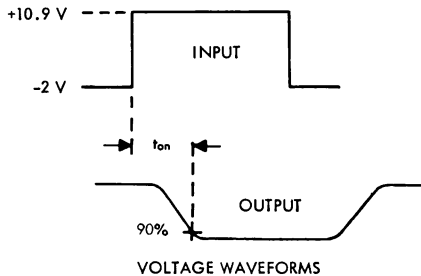
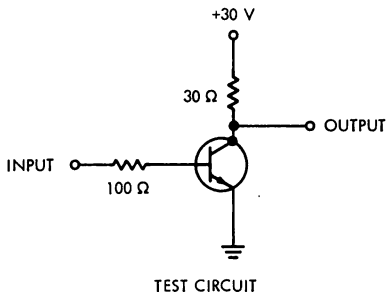

FIGURE 2 — 1-AMPERE TURN-ON TIME (2N3724A AND 2N3725A)

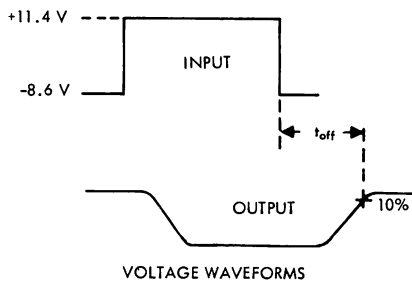
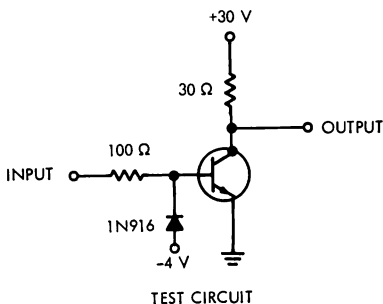

FIGURE 3 — 1-AMPERE TURN-OFF TIME (2N3724A AND 2N3725A)

NOTES: a. The input waveforms have the following characteristics:

For measuring turn-on time: $t_r \leq 2$ ns, $t_p = 200$ ns, duty cycle $\leq 2\%$.

For measuring turn-off time: $t_f \leq 3$ ns, $t_p = 200$ ns to 10μ s, duty cycle = 2% .

b. The output waveforms are monitored on an oscilloscope with the following characteristics: $t_r \leq 1$ ns, $R_{in} \geq 100$ k Ω , $C_{in} \leq 7$ pF.

*Indicates JEDEC registered data

TYPICAL CHARACTERISTICS

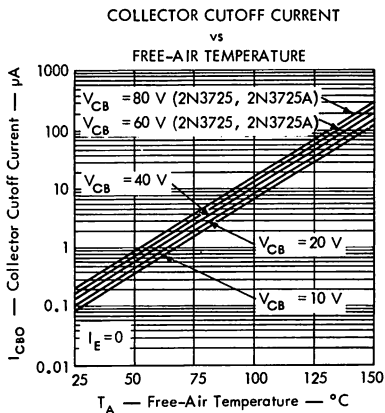

FIGURE 4

TYPES 2N3724, 2N3724A, 2N3725, 2N3725A N-P-N EPITAXIAL PLANAR SILICON TRANSISTORS

TYPICAL CHARACTERISTICS

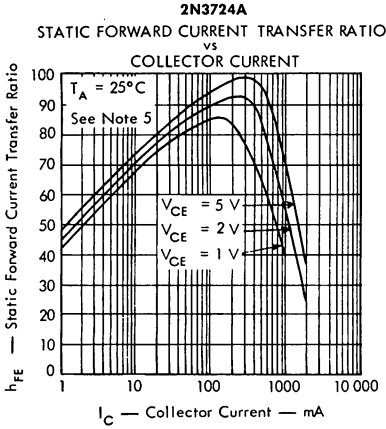

FIGURE 5

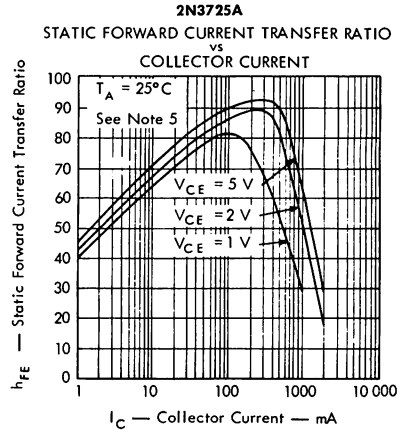

FIGURE 6

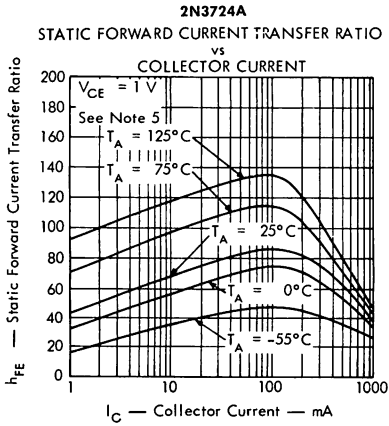

FIGURE 7

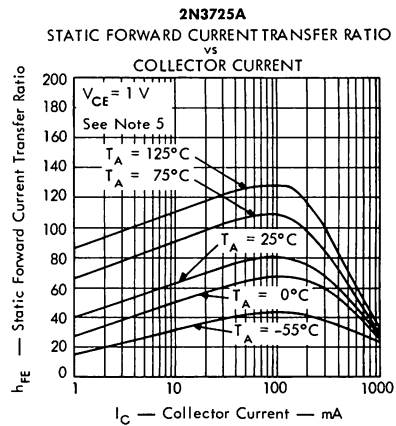

FIGURE 8

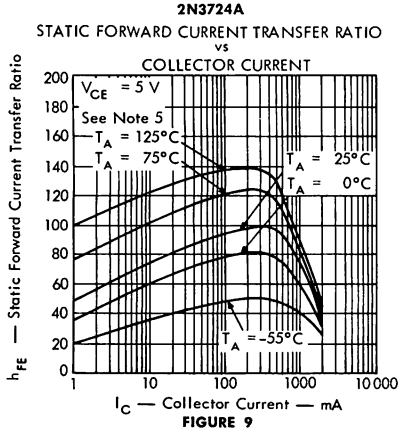

FIGURE 9

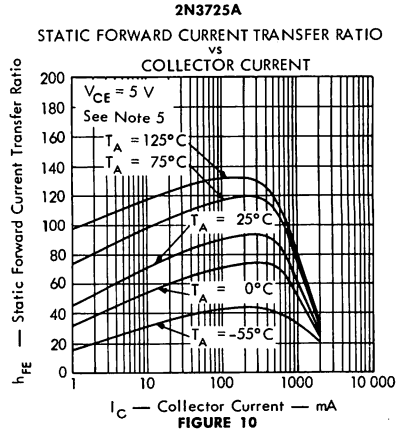
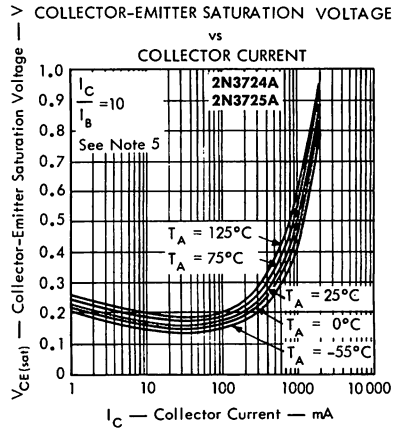
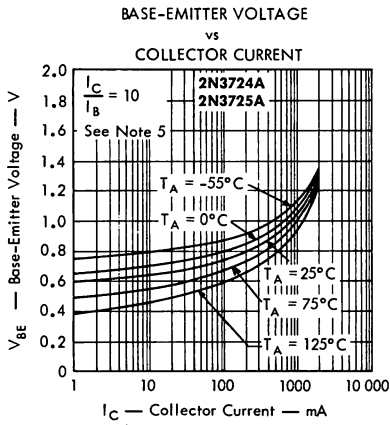

FIGURE 10

TYPES 2N3724, 2N3724A, 2N3725, 2N3725A N-P-N EPITAXIAL PLANAR SILICON TRANSISTORS

TYPICAL CHARACTERISTICS



COMMON-BASE OPEN-CIRCUIT INPUT CAPACITANCE
vs
EMITTER-BASE VOLTAGE

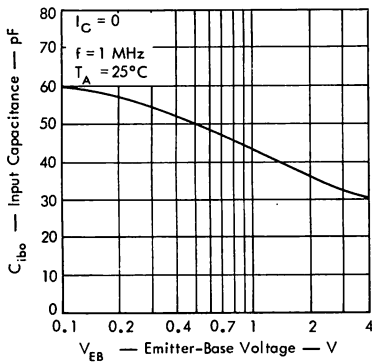

COMMON-BASE OPEN-CIRCUIT OUTPUT CAPACITANCE
vs
COLLECTOR-BASE VOLTAGE

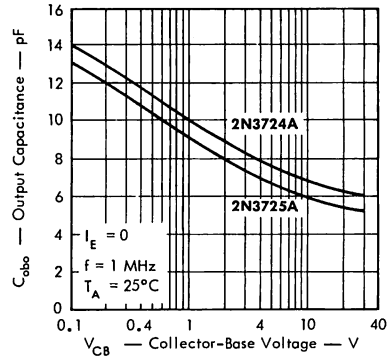

SMALL-SIGNAL COMMON-EMITTER
FORWARD CURRENT TRANSFER RATIO
vs
COLLECTOR CURRENT

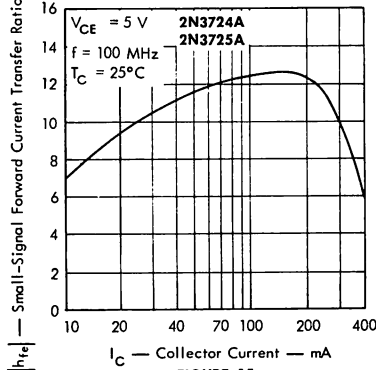

TYPES 2N3724, 2N3724A, 2N3725, 2N3725A N-P-N EPITAXIAL PLANAR SILICON TRANSISTORS

TYPICAL CHARACTERISTICS

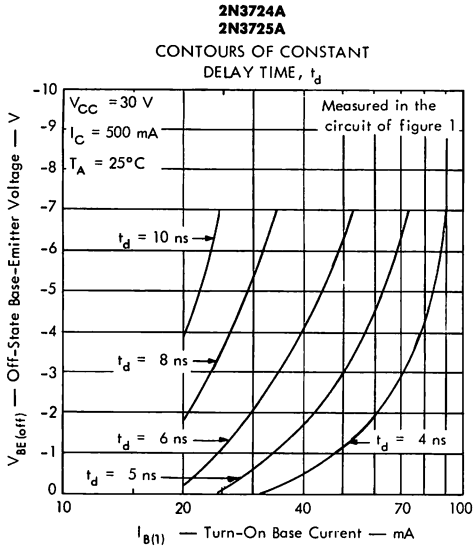

FIGURE 16

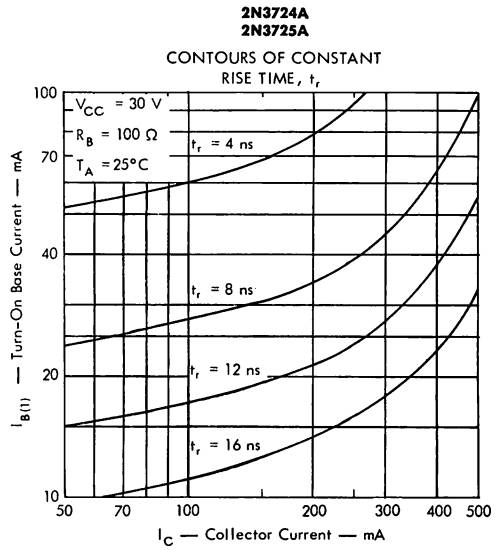

FIGURE 17

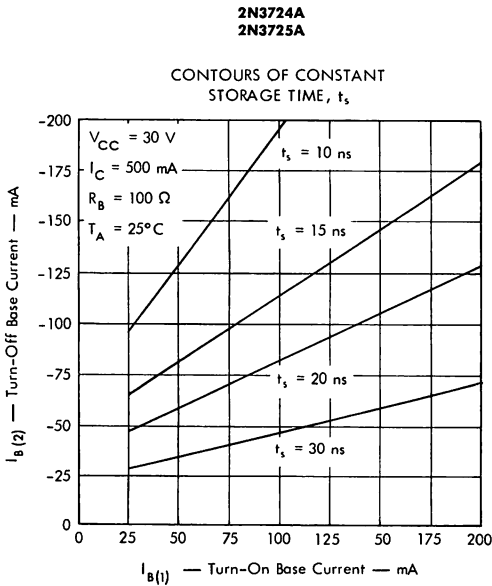

FIGURE 18

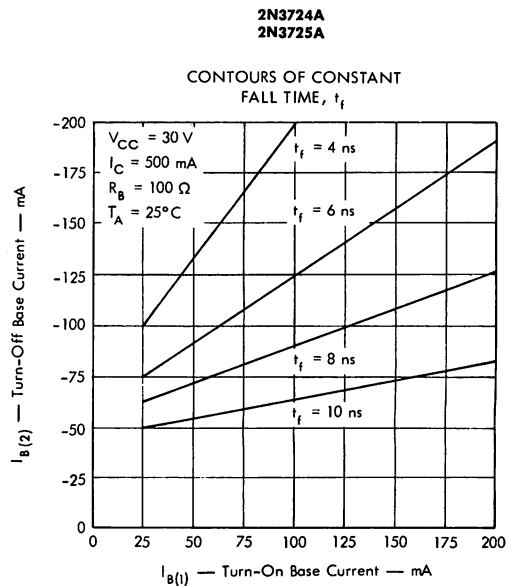

FIGURE 19

TYPES 2N3724, 2N3724A, 2N3725, 2N3725A

N-P-N EPITAXIAL PLANAR SILICON TRANSISTORS

TYPICAL CHARACTERISTICS

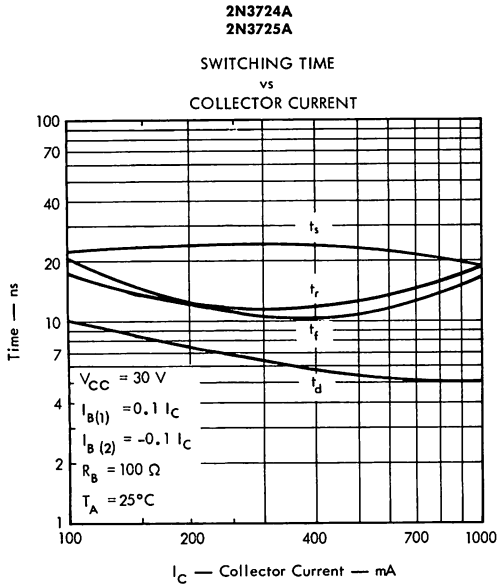

FIGURE 20

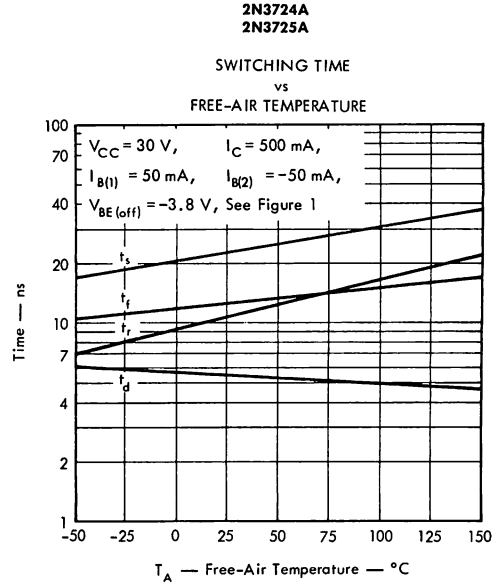

FIGURE 21

THERMAL INFORMATION

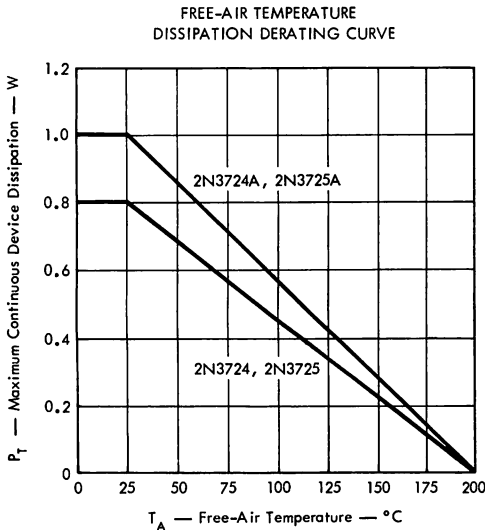

FIGURE 22

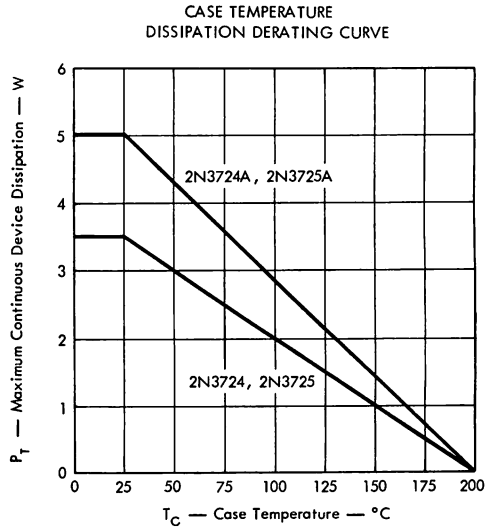

FIGURE 23

TYPES 2N3826, 2N3827, 2N4994, AND 2N4995 N-P-N PLANAR SILICON TRANSISTORS



HIGH-FREQUENCY SILECT† TRANSISTORS

For Applications as

- AM-FM IF Amplifiers
- AM RF Amplifiers and Oscillators
- FM Oscillators and Mixers

mechanical data

These transistors are encapsulated in a plastic compound specifically designed for this purpose, using a highly mechanized process developed by Texas Instruments. The case will withstand soldering temperatures without deformation. These devices exhibit stable characteristics under high-humidity conditions and are capable of meeting MIL-STD-202C method 106B. The transistors are insensitive to light.

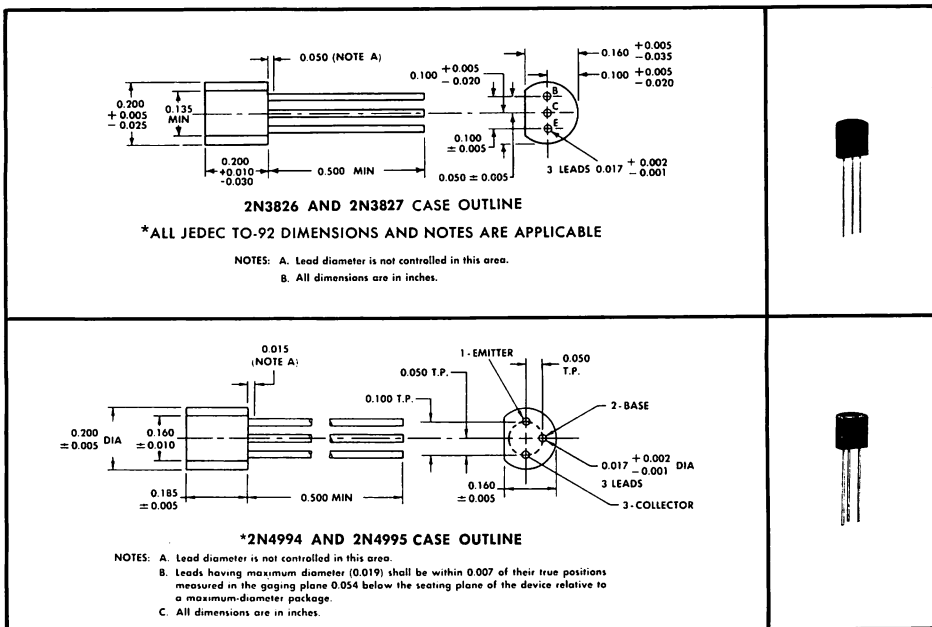

* absolute maximum ratings at 25°C free-air temperature (unless otherwise noted)

Collector-Base Voltage	60 V
Collector-Emitter Voltage (See Note 1)	45 V
Emitter-Base Voltage	4 V
Continuous Collector Current	30 mA
Continuous Device Dissipation at (or below) 25°C Free-Air Temperature (See Note 2)	360 mW
Storage Temperature Range	-65°C to 150°C
Lead Temperature 1/8 Inch from Case for 10 Seconds	260°C

NOTES: 1. This value applies when the base-emitter diode is open-circuited.

2. Derate linearly to 150°C free-air temperature at the rate of 2.88 mW/deg.

† Trademark of Texas Instruments

‡ Patent Pending

* Indicates JEDEC registered data (typical data excluded)

TYPES 2N3826, 2N3827, 2N4994, AND 2N4995
BULLETIN NO. DL-5 679606, OCTOBER 1967
REPLACES BULLETIN NO. DL-5 657503, MARCH 1965



TYPES 2N3826, 2N3827, 2N4994, AND 2N4995

N-P-N PLANAR SILICON TRANSISTORS

*electrical characteristics at 25°C free-air temperature (unless otherwise noted)

PARAMETER	TEST CONDITIONS	2N3826, 2N4994			2N3827, 2N4995			UNIT
		MIN	TYP	MAX	MIN	TYP	MAX	
$V_{(BR)CBO}$ Collector-Base Breakdown Voltage	$I_C = 100 \mu A, I_E = 0$	60			60			V
$V_{(BR)CEO}$ Collector-Emitter Breakdown Voltage	$I_C = 10 \text{ mA}, I_B = 0, \text{ See Note 3}$	45			45			V
$V_{(BR)EBO}$ Emitter-Base Breakdown Voltage	$I_E = 100 \mu A, I_C = 0$	4			4			V
I_{CBO} Collector Cutoff Current	$V_{CB} = 30 \text{ V}, I_E = 0$			100			100	nA
	$V_{CB} = 30 \text{ V}, I_E = 0, T_A = 85^\circ C$			5			5	μA
h_{FE} Static Forward Current Transfer Ratio	$V_{CE} = 10 \text{ V}, I_C = 10 \text{ mA}, \text{ See Note 3}$	40		160	100		400	
h_{fo} Small-Signal Common-Emitter Forward Current Transfer Ratio	$V_{CE} = 10 \text{ V}, I_C = 10 \text{ mA}, f = 455 \text{ kHz}$		42			45		dB
$ h_{fo} $ Small-Signal Common-Emitter Forward Current Transfer Ratio	$V_{CE} = 10 \text{ V}, I_C = 10 \text{ mA}, f = 100 \text{ MHz}$	2	3	8	2	3	8	
C_{obo} Common-Base Open-Circuit Output Capacitance	$V_{CB} = 10 \text{ V}, I_E = 0, f = 1 \text{ MHz}$		2.5	3.5		2.5	3.5	pF
$t_{b'C_c}$ Collector-Base Time Constant	$V_{CB} = 10 \text{ V}, I_E = -10 \text{ mA}, f = 79.8 \text{ MHz}$		45	100		45	100	ps

NOTE 3: These parameters must be measured using pulse techniques. $t_p = 300 \mu s$, duty cycle $\leq 2\%$.

operating characteristics at 25°C free-air temperature

PARAMETER	TEST CONDITIONS	TYP	UNIT
MAG Maximum Available Gain	$V_{CE} = 10 \text{ V}, I_C = 10 \text{ mA}, f = 10.7 \text{ MHz}, \text{ See Note 4}$	34	dB

NOTE 4: Maximum Available Gain, MAG, at frequency f in the higher frequency portion of the spectrum, is calculated from the formula $MAG \approx 4 \alpha_o f_T \times 10^4 \div f^2 t_{b'C_c}$ where f and f_T are in megahertz, $t_{b'C_c}$ is in picoseconds, and α_o is the low-frequency alpha, which for most practical design can be taken as unity. To obtain f_T , the $|h_{fo}|$ response with frequency is extrapolated at the rate of -6 dB/octave from $f = 100 \text{ MHz}$ to the frequency at which $|h_{fo}| = 1$.

THERMAL CHARACTERISTICS

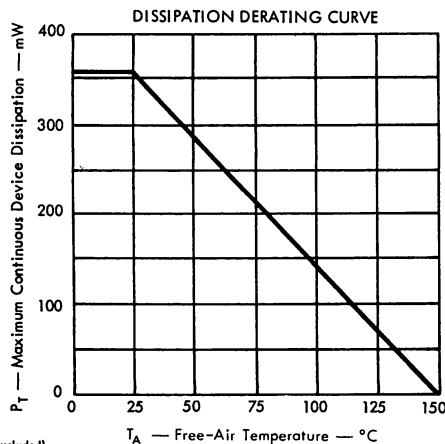

*Indicates JEDEC registered data (typical data excluded)

TYPE 2N4104 N-P-N PLANAR SILICON TRANSISTOR



DESIGNED FOR USE IN LOW-LEVEL, LOW-NOISE AMPLIFIERS

- **Guaranteed Low-Noise Characteristics**
at 10 c/s, 100 c/s, 1 kc/s, and 10 kc/s
- **Very High Guaranteed h_{FE} at**
 $I_C = 10 \mu A$: 400 Minimum
- **High Rated V_{EBO} : 10 V**

TYPE 2N4104
BULLETIN NO. DL-5 668315, JANUARY 1966

*mechanical data

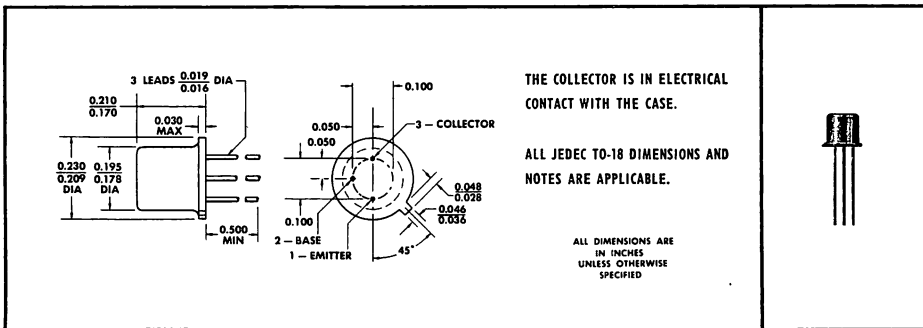

*absolute maximum ratings at 25°C free-air temperature (unless otherwise noted)

Collector-Base Voltage	60 V
Collector-Emitter Voltage (See Note 1)	60 V
Emitter-Base Voltage	10 V
Continuous Collector Current	50 mA
Continuous Device Dissipation at (or below) 25°C Free-Air Temperature (See Note 2)	0.3 W
Continuous Device Dissipation at (or below) 25°C Case Temperature (See Note 3)	1.2 W
Storage Temperature Range	-65°C to 200°C
Lead Temperature 1/8 Inch from Case for 10 Seconds	300°C

- NOTES: 1. This value applies between 0 and 10 mA when the base-emitter diode is open-circuited.
 2. Derate linearly to 175°C free-air temperature at the rate of 2 mW/deg.
 3. Derate linearly to 175°C case temperature at the rate of 8 mW/deg.

*Indicates JEDEC registered data.



TEXAS INSTRUMENTS
INCORPORATED
POST OFFICE BOX 5012 • DALLAS, TEXAS 75222

TYPE 2N4104

N-P-N PLANAR SILICON TRANSISTOR

*electrical characteristics at 25°C free-air temperature (unless otherwise noted)

PARAMETER	TEST CONDITIONS	MIN	MAX	UNIT	
$V_{(BR)CBO}$	Collector-Base Breakdown Voltage	$I_C = 10 \mu A, I_E = 0$	60	V	
$V_{(BR)CEO}$	Collector-Emitter Breakdown Voltage	$I_C = 10 \text{ mA}, I_B = 0$, See Note 4	60	V	
$V_{(BR)EBO}$	Emitter-Base Breakdown Voltage	$I_E = 10 \mu A, I_C = 0$	10	V	
I_{CBO}	Collector Cutoff Current	$V_{CB} = 45 \text{ V}, I_E = 0$	10	nA	
		$V_{CB} = 45 \text{ V}, I_E = 0, T_A = 150^\circ\text{C}$	10	μA	
I_{EBO}	Emitter Cutoff Current	$V_{EB} = 5 \text{ V}, I_C = 0$	10	nA	
h_{FE}	Static Forward Current Transfer Ratio	$V_{CE} = 5 \text{ V}, I_C = 1 \mu A$	150		
		$V_{CE} = 5 \text{ V}, I_C = 10 \mu A$	400	800	
		$V_{CE} = 5 \text{ V}, I_C = 100 \mu A$	450		
		$V_{CE} = 5 \text{ V}, I_C = 1 \text{ mA}$	500		
V_{BE}	Base-Emitter Voltage	$V_{CE} = 5 \text{ V}, I_C = 100 \mu A$	0.7	V	
$V_{CE(sat)}$	Collector-Emitter Saturation Voltage	$I_B = 0.1 \text{ mA}, I_C = 1 \text{ mA}$	0.3	V	
h_{ie}	Small-Signal Common-Emitter Input Impedance	$V_{CE} = 5 \text{ V},$ $I_C = 1 \text{ mA},$ $f = 1 \text{ kc/s}$	12	42	$k\Omega$
h_{fe}	Small-Signal Common-Emitter Forward Current Transfer Ratio		500	1400	
h_{re}	Small-Signal Common-Emitter Reverse Voltage Transfer Ratio		8×10^{-4}		
h_{oe}	Small-Signal Common-Emitter Output Admittance		8	60	μmho
$ h_{fe} $	Small-Signal Common-Emitter Forward Current Transfer Ratio	$V_{CE} = 5 \text{ V}, I_C = 0.5 \text{ mA}, f = 30 \text{ Mc/s}$	3	18	
C_{obo}	Common-Base Open-Circuit Output Capacitance	$V_{CB} = 5 \text{ V}, I_E = 0, f = 1 \text{ Mc/s}$	4.5		pF
C_{ibo}	Common-Base Open-Circuit Input Capacitance	$V_{EB} = 0.5 \text{ V}, I_C = 0, f = 1 \text{ Mc/s}$	6		pF

*operating characteristics at 25°C free-air temperature

PARAMETER	TEST CONDITIONS	MIN	MAX	UNIT	
NF	Spot Noise Figure	$V_{CE} = 5 \text{ V}, I_C = 30 \mu A, R_G = 10 \text{ k}\Omega,$ $f = 10 \text{ c/s}$	15		dB
		$V_{CE} = 5 \text{ V}, I_C = 30 \mu A, R_G = 10 \text{ k}\Omega,$ $f = 100 \text{ c/s}$	4		dB
		$V_{CE} = 5 \text{ V}, I_C = 5 \mu A, R_G = 50 \text{ k}\Omega,$ $f = 1 \text{ kc/s}$	1		dB
		$V_{CE} = 5 \text{ V}, I_C = 5 \mu A, R_G = 50 \text{ k}\Omega,$ $f = 10 \text{ kc/s}$	1		dB

NOTE 4: This parameter must be measured using pulse techniques: $t_p = 300 \mu s$, duty cycle $\leq 2\%$.

*Indicates JEDEC registered data.

TYPES 2N4252 AND 2N4253 N-P-N EPITAXIAL PLANAR SILICON TRANSISTORS



TYPES 2N4252 AND 2N4253
BULLETIN NO. DL-5-66875, APRIL 1966

HIGH-FREQUENCY TRANSISTORS FOR TUNER AND IF-AMPLIFIER STAGES IN FM AND AM/FM STEREO-MULTIPLEX RECEIVERS

*mechanical data

THE ACTIVE ELEMENTS ARE ELECTRICALLY INSULATED FROM THE CASE

ALL JEDEC TO-72† DIMENSIONS AND NOTES ARE APPLICABLE

†TO-72 outline is same as TO-18 outline with the addition of a fourth lead.

*absolute maximum ratings at 25°C free-air temperature (unless otherwise noted)

Collector-Base Voltage	30 V
Collector-Emitter Voltage (See Note 1)	18 V
Emitter-Base Voltage	4 V
Continuous Collector Current	50 mA
Continuous Device Dissipation at (or below) 25°C Free-Air Temperature (See Note 2)	200 mW
Storage Temperature Range	-65°C to 200°C
Lead Temperature 1/8 Inch from Case for 10 Seconds	300°C

*electrical characteristics at 25°C free-air temperature (unless otherwise noted)

PARAMETER	TEST CONDITIONS	2N4252			2N4253			UNIT
		MIN	TYP	MAX	MIN	TYP	MAX	
$V_{(BR)CBO}$ Collector-Base Breakdown Voltage	$I_C = 10 \mu A, I_E = 0$	30			30			V
$V_{(BR)CEO}$ Collector-Emitter Breakdown Voltage	$I_C = 2 \text{ mA}, I_B = 0$, See Note 3	18			18			V
$V_{(BR)EBO}$ Emitter-Base Breakdown Voltage	$I_E = 10 \mu A, I_C = 0$	4			4			V
I_{CBO} Collector Cutoff Current	$V_{CB} = 15 \text{ V}, I_E = 0$			50			50	nA
	$V_{CB} = 15 \text{ V}, I_E = 0, T_A = 85^\circ C$			5			5	μA
h_{FE} Static Forward Current Transfer Ratio	$V_{CE} = 10 \text{ V}, I_C = 2 \text{ mA}$	50			30	150		
$ h_{fe} $ Small-Signal Common-Emitter Forward Current Transfer Ratio	$V_{CE} = 10 \text{ V}, I_C = 2 \text{ mA}, f = 100 \text{ MHz}$	6	14		6	14		
$ y_{fe} $ Small-Signal Common-Emitter Forward Transfer Admittance	$V_{CE} = 10 \text{ V}, I_C = 2 \text{ mA}, f = 10 \text{ MHz}$				70			mmho
C_{cb} Collector-Base Capacitance	$V_{CB} = 10 \text{ V}, I_E = 0, f = 1 \text{ MHz}$, See Note 4	0.1	0.45		0.1	0.45		pF
r_{oep} Parallel-Equivalent Common-Emitter Short-Circuit Output Resistance	$V_{CE} = 10 \text{ V}, I_C = 2 \text{ mA}, f = 10 \text{ MHz}$				50			k Ω
$\tau_b' C_c$ Collector-Base Time Constant	$V_{CB} = 10 \text{ V}, I_E = -2 \text{ mA}, f = 79.8 \text{ MHz}$	8	12		8	12		ps

- NOTES: 1. This value applies when base-emitter diode is open-circuited. *Indicates JEDEC registered data (typical data excluded).
 2. Derate linearly to 175°C free-air temperature at the rate of 1.33 mW/deg.
 3. These parameters must be measured using pulse techniques. $t_p = 300 \mu s$, duty cycle $\leq 2\%$.
 4. Collector-Base Capacitance is measured using three-terminal measurement techniques with the case and emitter guarded.

TYPES 2N4252 AND 2N4253

N-P-N EPITAXIAL PLANAR SILICON TRANSISTORS

operating characteristics at 25°C free-air temperature

PARAMETER	TEST CONDITIONS	2N4252	UNIT
		TYP	
NF Spot Noise Figure	$V_{CE} = 10 \text{ V}$, $I_C = 2 \text{ mA}$, $R_E = 100 \Omega$, $f = 100 \text{ MHz}$	2.5	dB

TYPICAL CHARACTERISTICS

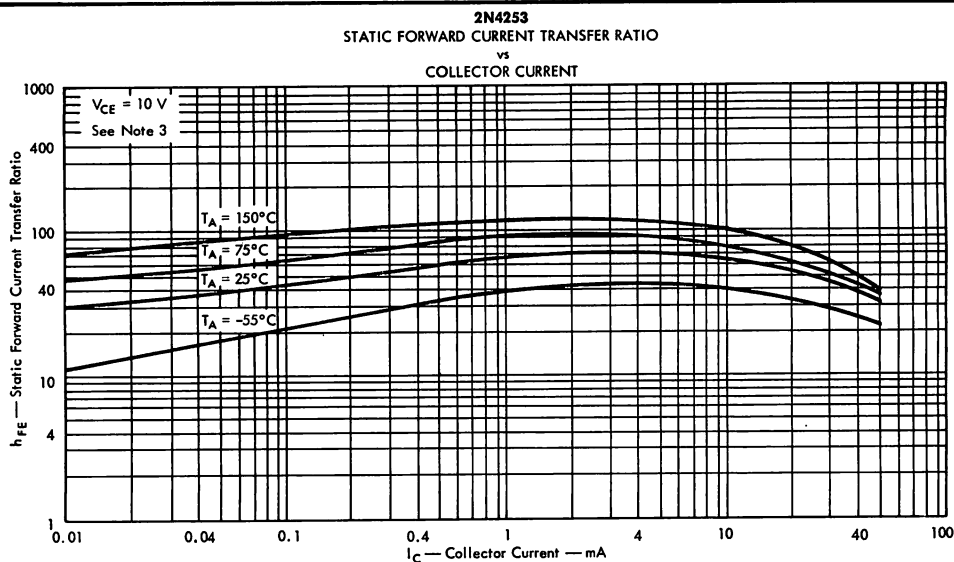

FIGURE 1

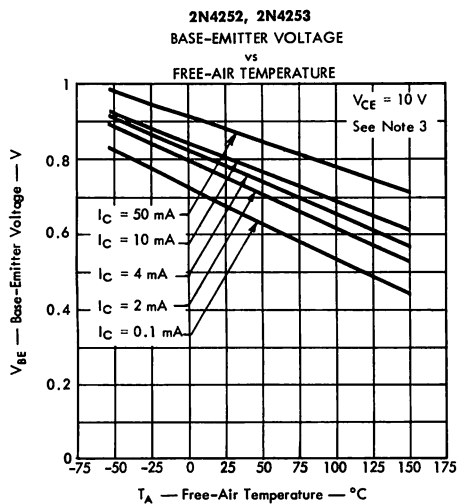

FIGURE 2

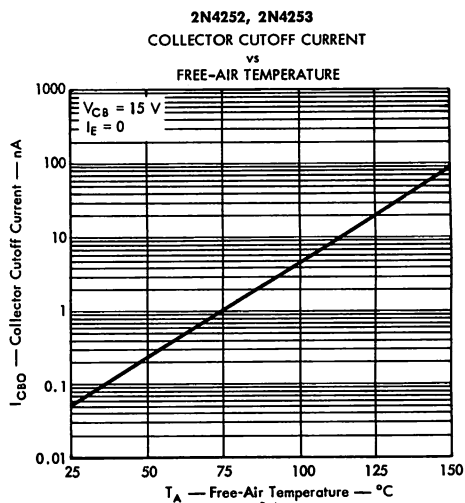

FIGURE 3

NOTE 3: These parameters must be measured using pulse techniques. $t_p = 300 \mu\text{s}$, duty cycle $\leq 2\%$.

TYPES 2N4252 AND 2N4253 N-P-N EPITAXIAL PLANAR SILICON TRANSISTORS

TYPICAL CHARACTERISTICS AT $T_A = 25^\circ\text{C}$

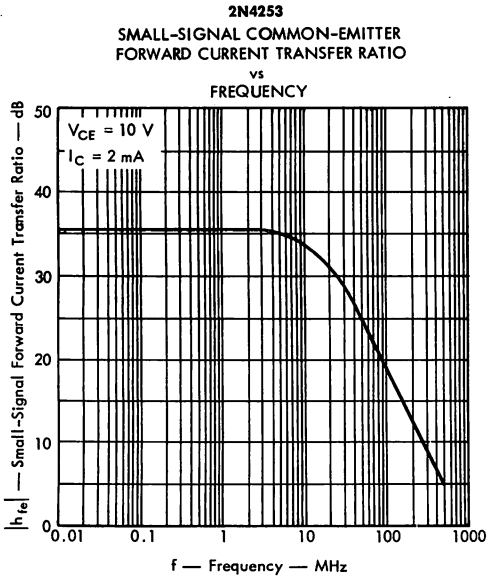

FIGURE 4

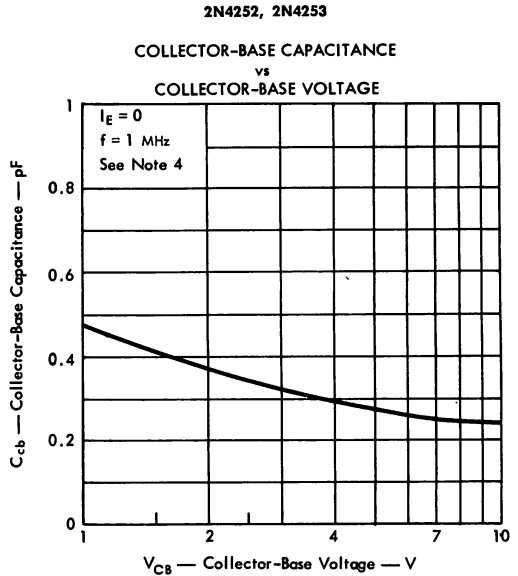

FIGURE 5

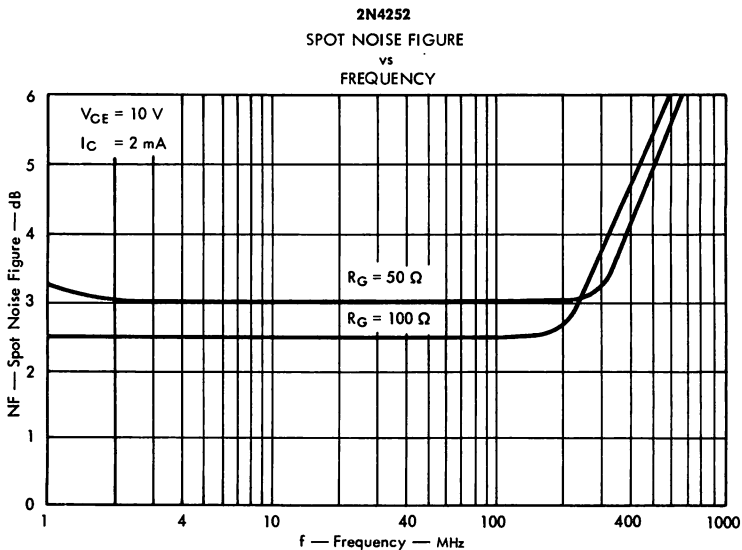
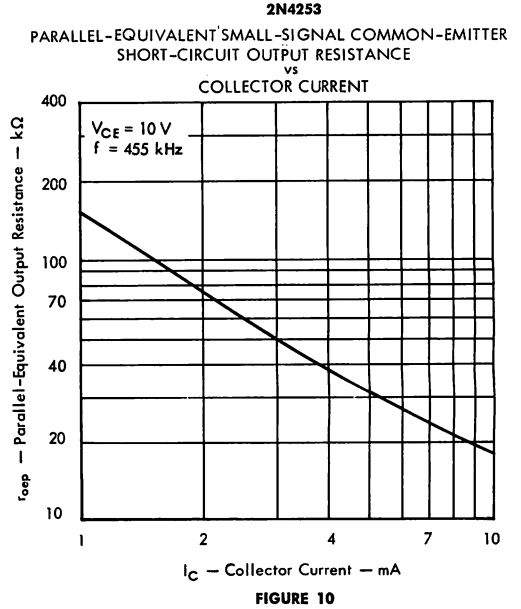
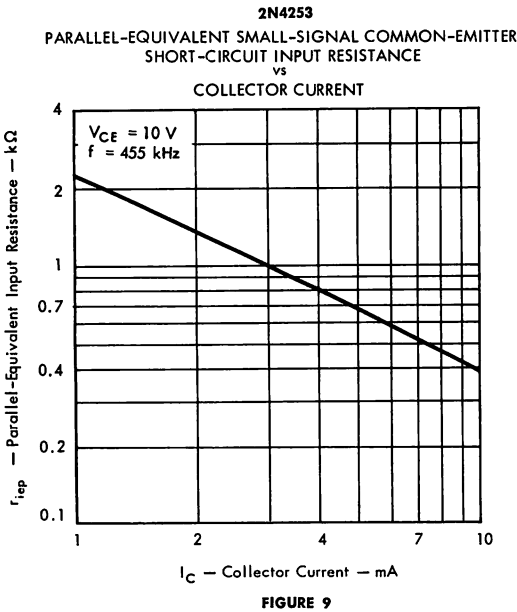
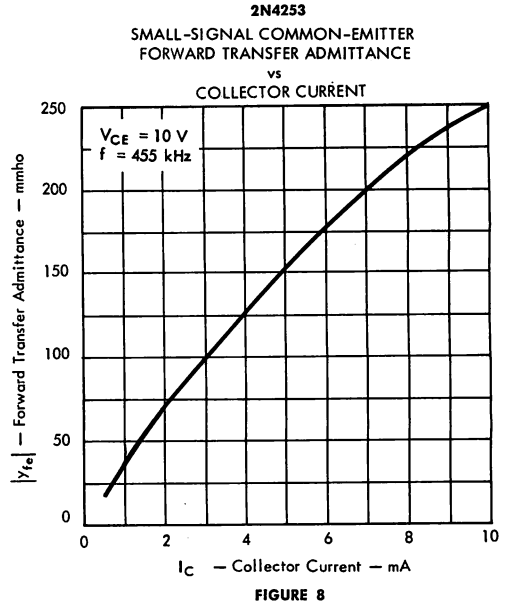
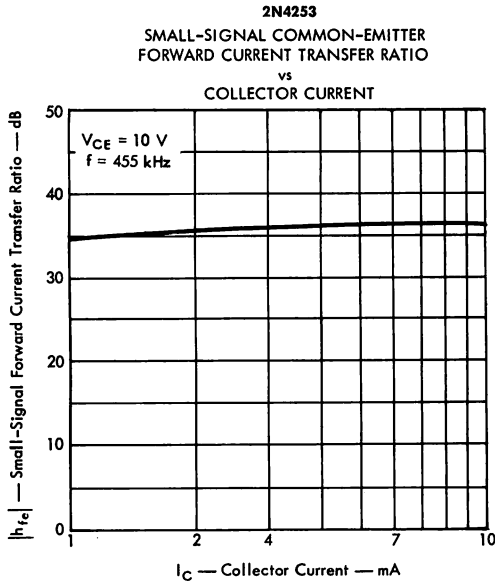

FIGURE 6

NOTE 4: Collector-Base Capacitance is measured using three-terminal measurement techniques with the case and emitter guarded.

TYPES 2N4252 AND 2N4253 N-P-N EPITAXIAL PLANAR SILICON TRANSISTORS

TYPICAL CHARACTERISTICS AT 455 kHz, $T_A = 25^\circ\text{C}$



TYPES 2N4252 AND 2N4253 N-P-N EPITAXIAL PLANAR SILICON TRANSISTORS

TYPICAL CHARACTERISTICS AT 10 MHz, $T_A = 25^\circ\text{C}$

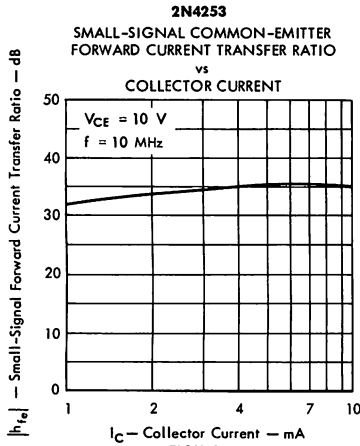

FIGURE 11

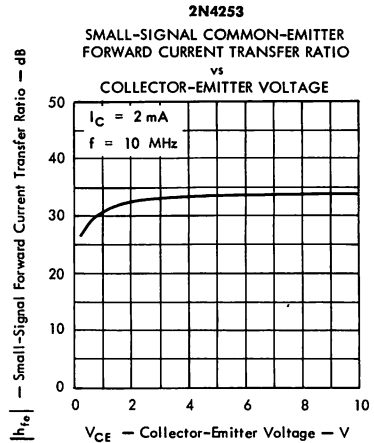

FIGURE 12

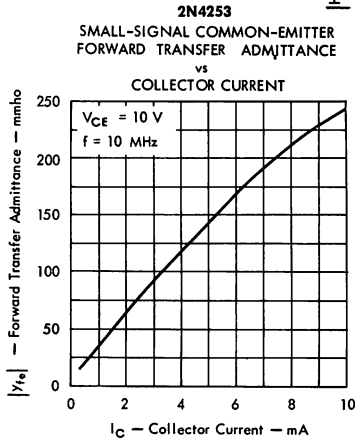

FIGURE 13

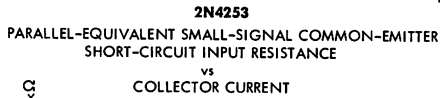

FIGURE 14

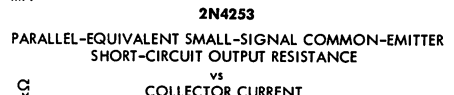

FIGURE 15

TYPES 2N4252 AND 2N4253

N-P-N EPITAXIAL PLANAR SILICON TRANSISTORS

TYPICAL CHARACTERISTICS AT 100 MHz, $T_A = 25^\circ\text{C}$

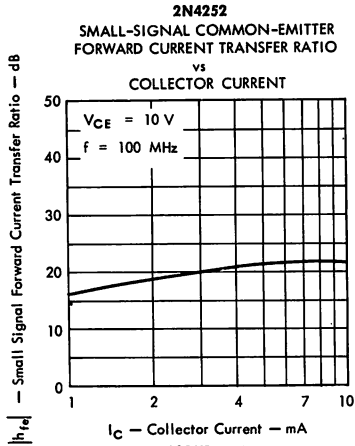

FIGURE 16

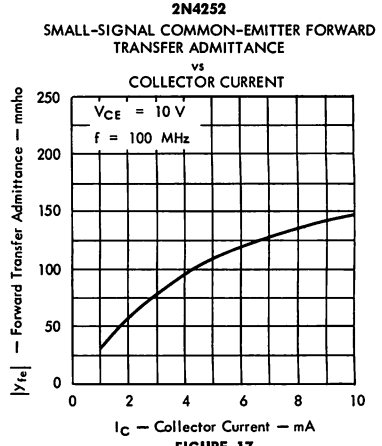

FIGURE 17

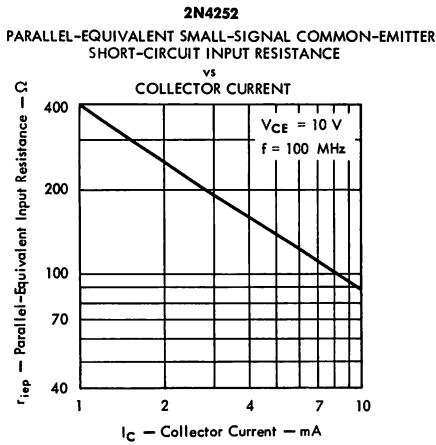

FIGURE 18

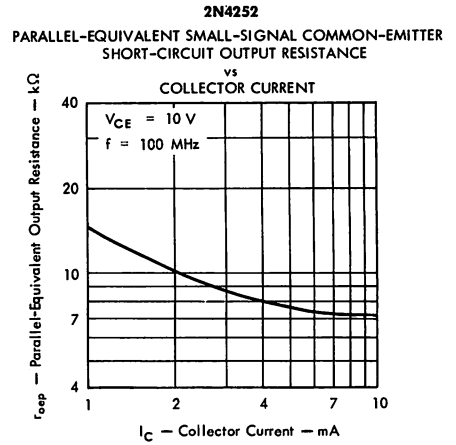
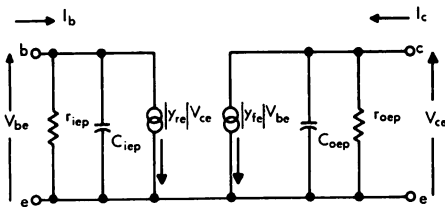

FIGURE 19

COMMON-EMITTER EQUIVALENT CIRCUIT USING SHORT-CIRCUIT "y" PARAMETERS



$$I_b = |y_{ie}|V_{be} + |y_{re}|V_{ce}$$

$$I_c = |y_{fe}|V_{be} + |y_{oe}|V_{ce}$$

$$|y_{ie}| = \left. \frac{I_b}{V_{be}} \right|_{V_{ce} = 0} = \frac{1}{r_{iep}} + j\omega C_{iep}$$

$$|y_{fe}| = \left. \frac{I_c}{V_{be}} \right|_{V_{ce} = 0}$$

$$|y_{re}| = \left. \frac{I_b}{V_{ce}} \right|_{V_{be} = 0}$$

$$|y_{oe}| = \left. \frac{I_c}{V_{ce}} \right|_{V_{be} = 0} = \frac{1}{r_{oep}} + j\omega C_{oep}$$

FIGURE 20

TYPES 2N4252 AND 2N4253 N-P-N EPITAXIAL PLANAR SILICON TRANSISTORS

TYPICAL APPLICATION DATA

TYPICAL FM TUNER

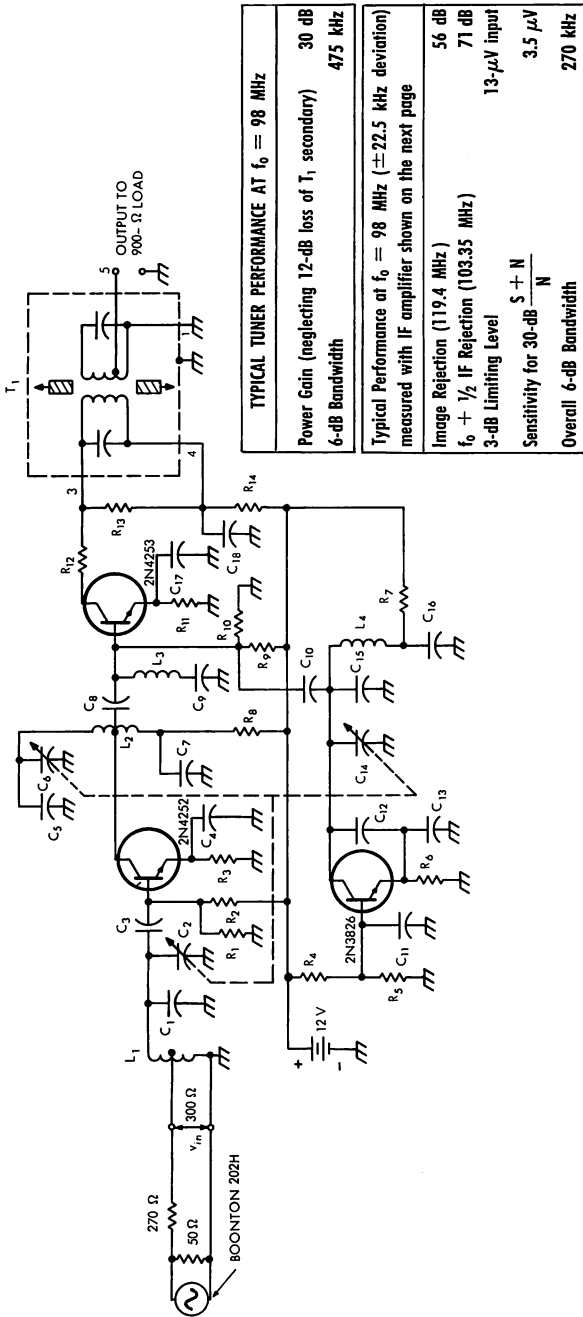

CIRCUIT COMPONENT INFORMATION

- TRANSFORMER**
- T_1 : TRW #21160-R1 (or equivalent)
- COILS**
- L_1 : 4T #18 bus, $1/4$ " ID, $1/2$ " length, Turns Ratio 2.7:1
- L_2 : 4T #18 bus, $1/4$ " ID, $1/2$ " length, Turns Ratio 2.7:1
- L_3 : 1 μ H
- L_4 : 3T #18 bus, $3/8$ " ID, $3/8$ " length
- RESISTORS**
- R_1 : 1 k Ω
 R_2 : 4.7 k Ω
 R_3 : 1 k Ω
 R_4 : 9.1 k Ω
 R_5 : 2.7 k Ω
 R_6 : 1 k Ω
 R_7 : 330 Ω
- R_8 : 330 Ω
 R_9 : 10 k Ω
 R_{10} : 2.7 k Ω
 R_{11} : 820 Ω
 R_{12} : 470 Ω
 R_{13} : 9.1 k Ω
 R_{14} : 330 Ω
- CAPACITORS**
- C_1 : 10 pF
 C_2 : \dagger
 C_3 : 3.3 pF
 C_4 : 0.001 μ F
 C_5 : 10 pF
 C_6 : \dagger
 C_7 : 0.001 μ F
 C_8 : 12 pF
 C_9 : 240 pF Dura Mica
- C_{10} : 1.2 pF
 C_{11} : 0.001 μ F
 C_{12} : 6.8 pF
 C_{13} : 4.7 pF
 C_{14} : \dagger
 C_{15} : 10 pF
 C_{16} : 0.001 μ F
 C_{17} : 0.01 μ F
 C_{18} : 0.01 μ F
- $\dagger C_2, C_6, C_{14}$: TRW #V0693, Model 57-3A, or equivalent
- All resistors $1/2$ W, ten percent tolerance

TYPES 2N4252 AND 2N4253 N-P-N EPITAXIAL PLANAR SILICON TRANSISTORS

TYPICAL APPLICATION DATA

TYPICAL FM PERFORMANCE	
Data Taken with input on base of transistor Q ₁ IF frequency = 10.7 MHz	
1. Overall 6-dB Bandwidth (measured on base of Q ₃)	300 kHz
2. Average Power Gain per Stage	26 dB
3. FM 3-dB Limiting Level	180 μV input
4. AM Rejection at 3-dB Limiting Level	> 30 dB
5. Maximum Audio Recovery (Full Limiting)	175 mV
±75 kHz Deviation	570 mV
6. Peak-to-Peak Separation of Ratio Detector	700 kHz

TYPICAL AM PERFORMANCE	
Data taken using Measurements Corporation signal generator for model 65-B with a 0.05 μF capacitor and an 82 kΩ resistor in series with generator output.	
IF frequency = 455 kHz	
1. Overall 6-dB Bandwidth	10.6 kHz
2. Overall 20-dB Bandwidth	18.6 kHz
3. Maximum Audio Output (30% Modulation)	350 mV
4. AM Sensitivity at Pin 3 of T ₅ for 20 mV Output (30% Modulation)	0.3 mV
5. AGC Figure-of-Merit	42 dB

TYPICAL AM/FM IF AMPLIFIER

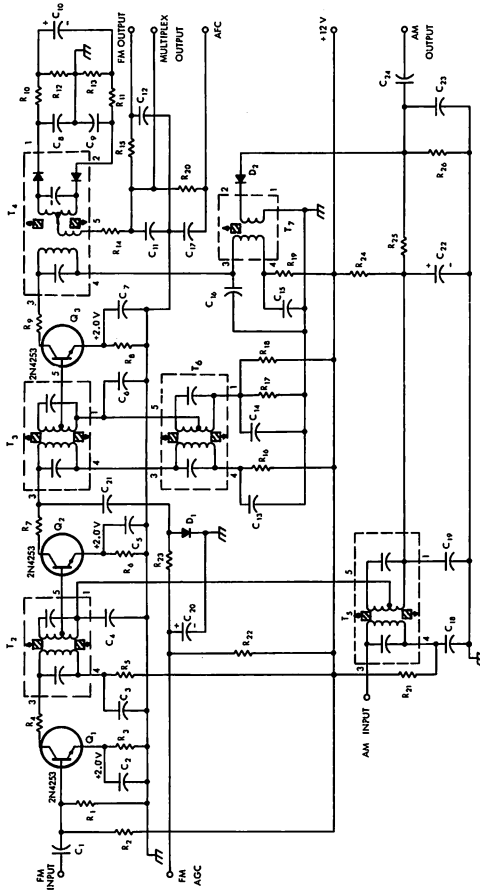

CIRCUIT COMPONENT INFORMATION

RESISTORS

R ₁ : 10 kΩ	R ₁₄ : 68 Ω	C ₁ : 0.02 μF
R ₂ : 33 kΩ	R ₁₅ : 7.5 kΩ	C ₂ : 0.01 μF
R ₃ : 1 kΩ	R ₁₆ : 330 Ω	C ₃ : 0.01 μF
R ₄ : 220 Ω	R ₁₇ : 2.7 kΩ	C ₄ : 0.001 μF
R ₅ : 330 Ω	R ₁₈ : 8.2 kΩ	C ₅ : 0.05 μF
R ₆ : 1 kΩ	R ₁₉ : 330 Ω	C ₆ : 0.001 μF
R ₇ : 220 Ω	R ₂₀ : 200 kΩ	C ₇ : 0.05 μF
R ₈ : 470 Ω	R ₂₁ : 330 Ω	C ₈ : 0.05 μF
R ₁₀ : 1.5 kΩ	R ₂₂ : 33 kΩ	C ₉ : 330 pF
R ₁₁ : 1 kΩ	R ₂₃ : 4.7 kΩ	C ₁₀ : 330 pF
R ₁₂ : 8.2 kΩ	R ₂₄ : 82 kΩ	C ₁₁ : 330 pF
R ₁₃ : 8.2 kΩ	R ₂₅ : 27 kΩ	C ₁₂ : 0.01 μF
	R ₂₆ : 3.3 kΩ	

TRANSFORMERS

- T₁: Output Transformer of FM Tuner
- T₂: TRW #21161-R1 (or equivalent)
- T₃: TRW #21162-R1 (or equivalent)
- T₄: TRW #20061-R1 (or equivalent)
- T₅: TRW #21205-R1 (or equivalent)
- T₆: TRW #21204-R1 (or equivalent)
- T₇: TRW #18304-R1 (or equivalent)

DIODES

- D₁: 1N4531
- D₂: 1N295

All resistors 1/2 W, ten percent tolerance

CAPACITORS

- C₁₃: 0.05 μF
- C₁₄: 0.05 μF
- C₁₅: 0.05 μF
- C₁₆: 0.0015 μF
- C₁₇: 0.05 μF
- C₁₈: 0.05 μF
- C₁₉: 0.05 μF
- C₂₀: 5 μF, 10 V, electrolytic
- C₂₁: 6.8 pF
- C₂₂: 5 μF, 10 V, electrolytic
- C₂₃: 0.05 μF
- C₂₄: 5 μF, 15 V, electrolytic, Polarity determined by following stage

TYPES 2N4254, 2N4255, 2N4996, AND 2N4997 N-P-N EPITAXIAL PLANAR SILICON TRANSISTORS



SILECT† HIGH-FREQUENCY TRANSISTORS FOR TUNER AND IF-AMPLIFIER STAGES

IN FM AND AM/FM STEREO-MULTIPLEX RECEIVERS

- Rugged, One-Piece Construction with In-Line Lead Configuration (2N4254, 2N4255) or Standard TO-18 100-mil Pin-Circle Configuration (2N4996, 2N4997)

TYPES 2N4254, 2N4255, 2N4996, AND 2N4997
BULLETIN NO. DL-5 679593, OCTOBER 1967
REPLACES BULLETIN NO. DL-5 668495, MAY 1966

mechanical data

These transistors are encapsulated in a plastic compound specifically designed for this purpose, using a highly mechanized process‡ developed by Texas Instruments. The case will withstand soldering temperatures without deformation. These devices exhibit stable characteristics under high-humidity conditions and are capable of meeting MIL-STD-202C method 106B. The transistors are insensitive to light.

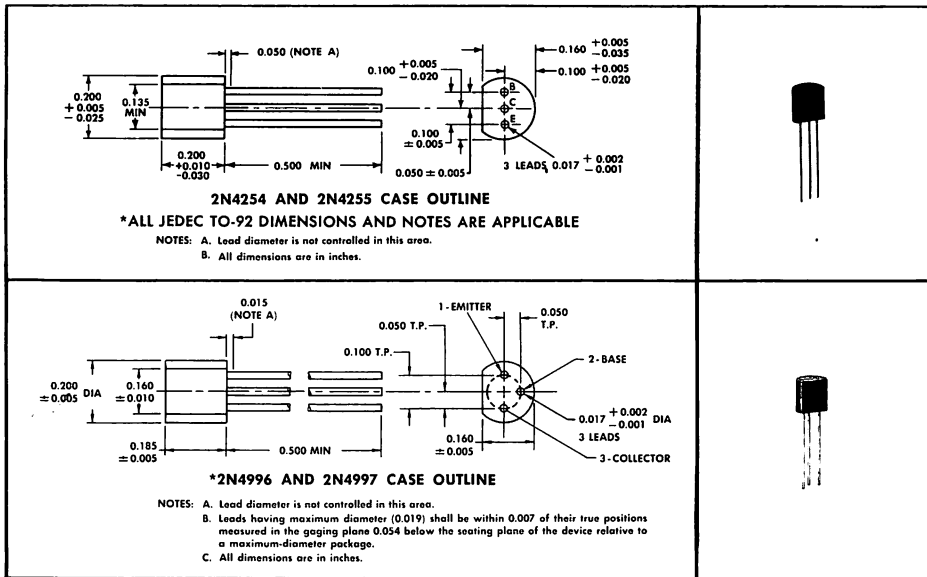

*absolute maximum ratings at 25°C free-air temperature (unless otherwise noted)

Collector-Base Voltage	30 V
Collector-Emitter Voltage (See Note 1)	18 V
Emitter-Base Voltage	4 V
Continuous Collector Current	50 mA
Continuous Device Dissipation at (or below) 25°C Free-Air Temperature (See Note 2)	250 mW
Storage Temperature Range	-65°C to 150°C
Lead Temperature ¼ Inch from Case for 10 Seconds	260°C

- NOTES: 1. This value applies when the base-emitter diode is open-circuited.
2. Derate linearly to 150°C free-air temperature at the rate of 2 mW/deg.

*Indicates JEDEC registered data
†Trademark of Texas Instruments
‡Patent Pending

TYPES 2N4254, 2N4255, 2N4996, AND 2N4997 N-P-N EPITAXIAL PLANAR SILICON TRANSISTORS

*electrical characteristics at 25°C free-air temperature (unless otherwise noted)

PARAMETER	TEST CONDITIONS	2N4254, 2N4996		2N4255, 2N4997		UNIT
		MIN	TYP MAX	MIN	TYP MAX	
$V_{(BR)CBO}$ Collector-Base Breakdown Voltage	$I_C = 10 \mu A, I_E = 0$	30		30		V
$V_{(BR)CEO}$ Collector-Emitter Breakdown Voltage	$I_C = 2 \text{ mA}, I_B = 0, \text{ See Note 3}$	18		18		V
$V_{(BR)EBO}$ Emitter-Base Breakdown Voltage	$I_E = 10 \mu A, I_C = 0$	4		4		V
I_{CBO} Collector Cutoff Current	$V_{CB} = 15 \text{ V}, I_E = 0$		100		100	nA
	$V_{CB} = 15 \text{ V}, I_E = 0, T_A = 85^\circ \text{C}$		10		10	μA
h_{FE} Static Forward Current Transfer Ratio	$V_{CE} = 10 \text{ V}, I_C = 2 \text{ mA}$	50		30	150	
$ h_{fe} $ Small-Signal Common-Emitter Forward Current Transfer Ratio	$V_{CE} = 10 \text{ V}, I_C = 2 \text{ mA}, f = 100 \text{ MHz}$	6	14	6	14	
$ y_{fe} $ Small-Signal Common-Emitter Forward Transfer Admittance	$V_{CE} = 10 \text{ V}, I_C = 2 \text{ mA}, f = 10 \text{ MHz}$			70		mmho
C_{cb} Collector-Base Capacitance	$V_{CB} = 10 \text{ V}, I_E = 0, f = 1 \text{ MHz}, \text{ See Note 4}$	0.1	0.65	0.1	0.65	pF
r_{oep} Parallel-Equivalent Common-Emitter Short-Circuit Output Resistance	$V_{CE} = 10 \text{ V}, I_C = 2 \text{ mA}, f = 10 \text{ MHz}$			50		k Ω
τ_b, τ_c Collector-Base Time Constant	$V_{CB} = 10 \text{ V}, I_E = -2 \text{ mA}, f = 79.8 \text{ MHz}$	14	20	14	20	ps

operating characteristics at 25°C free-air temperature

PARAMETER	TEST CONDITIONS	2N4254, 2N4996		UNIT
		TYP		
NF Spot Noise Figure	$V_{CE} = 10 \text{ V}, I_C = 2 \text{ mA}, R_G = 100 \Omega, f = 100 \text{ MHz}$	2.5		dB

*Indicates JEDEC registered data (typical data excluded)

TYPICAL CHARACTERISTICS

2N4255, 2N4997
STATIC FORWARD CURRENT TRANSFER RATIO
vs
COLLECTOR CURRENT

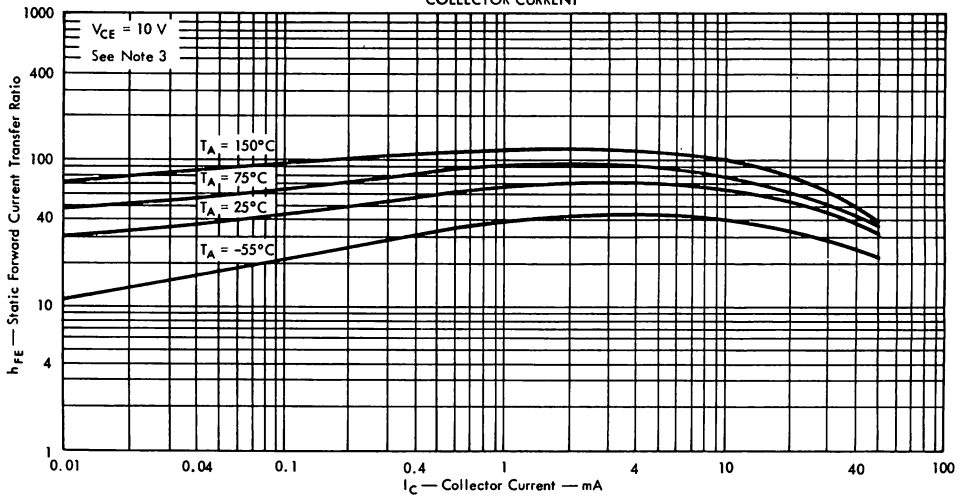
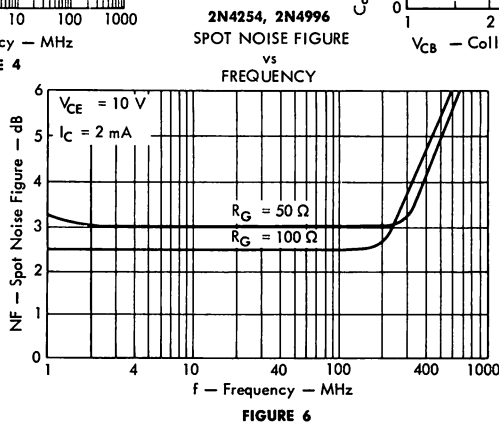
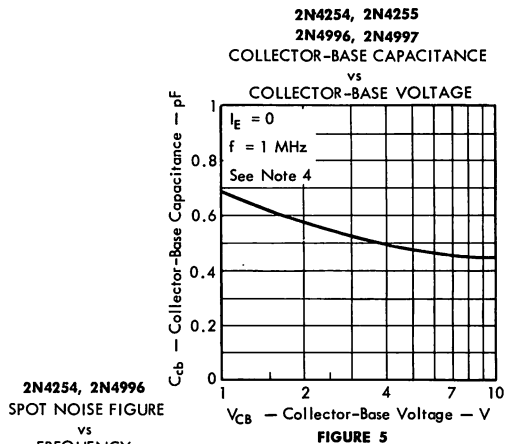
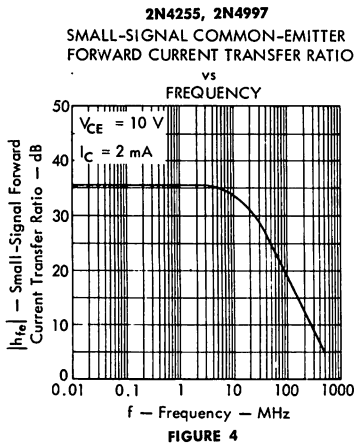
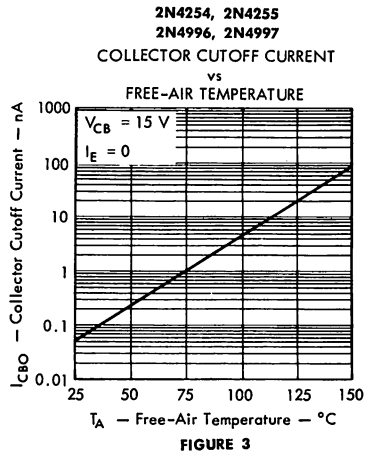
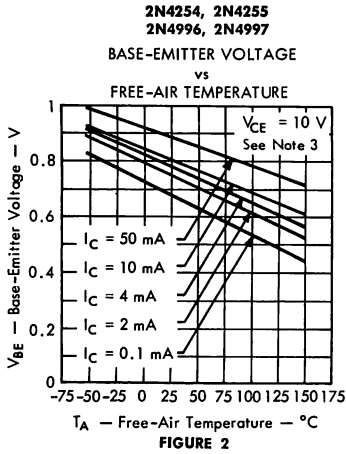

FIGURE 1

- NOTES: 3. This parameter must be measured using pulse techniques. $t_p = 300 \mu s$, duty cycle $\leq 2\%$.
4. Collector-Base Capacitance is measured using three-terminal measurement techniques with the emitter guarded.

TYPES 2N4254, 2N4255, 2N4996, AND 2N4997 N-P-N EPITAXIAL PLANAR SILICON TRANSISTORS

TYPICAL CHARACTERISTICS AT $T_A = 25^\circ\text{C}$



NOTES: 3. These parameters must be measured using pulse techniques. $t_p = 300\ \mu\text{s}$, duty cycle $\leq 2\%$.

4. Collector-Base Capacitance is measured using three-terminal measurement techniques with the case and emitter guarded.

TYPES 2N4254, 2N4255, 2N4996, AND 2N4997 N-P-N EPITAXIAL PLANAR SILICON TRANSISTORS

TYPICAL CHARACTERISTICS AT 455 kHz, $T_A = 25^\circ\text{C}$

2N4255, 2N4997
SMALL-SIGNAL COMMON-EMITTER
FORWARD CURRENT TRANSFER RATIO
vs
COLLECTOR CURRENT

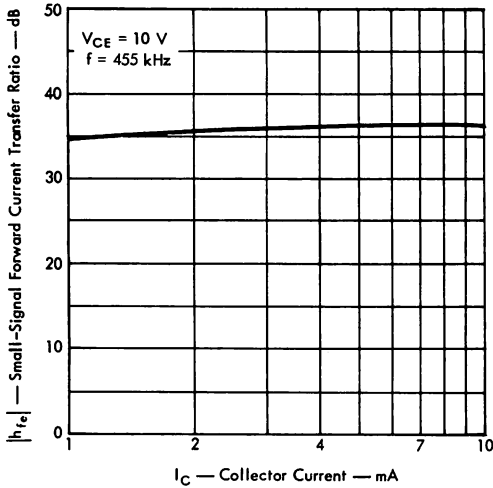

FIGURE 7

2N4255, 2N4997
SMALL-SIGNAL COMMON-EMITTER
FORWARD TRANSFER ADMITTANCE
vs
COLLECTOR CURRENT

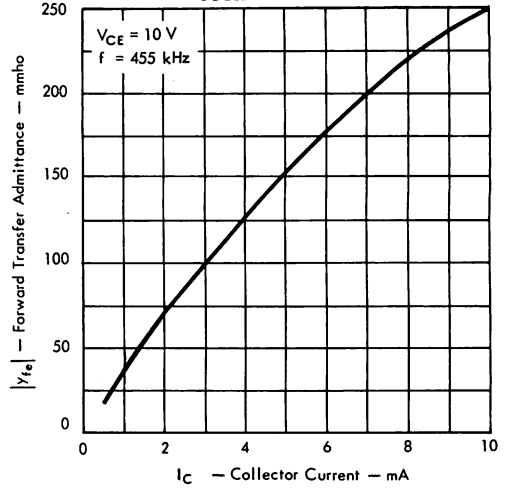

FIGURE 8

2N4255, 2N4997
PARALLEL-EQUIVALENT SMALL-SIGNAL COMMON-EMITTER
SHORT-CIRCUIT INPUT RESISTANCE
vs
COLLECTOR CURRENT

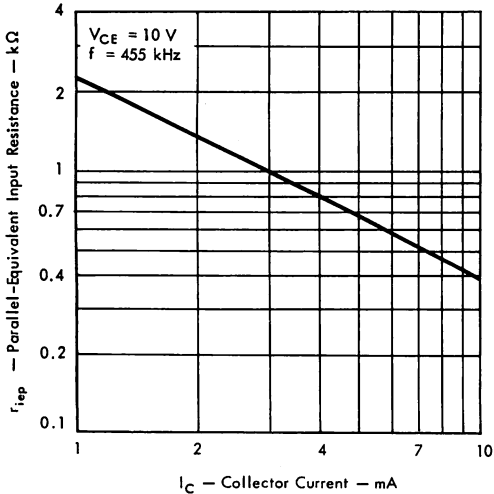

FIGURE 9

2N4255, 2N4997
PARALLEL-EQUIVALENT SMALL-SIGNAL COMMON-EMITTER
SHORT-CIRCUIT OUTPUT RESISTANCE
vs
COLLECTOR CURRENT

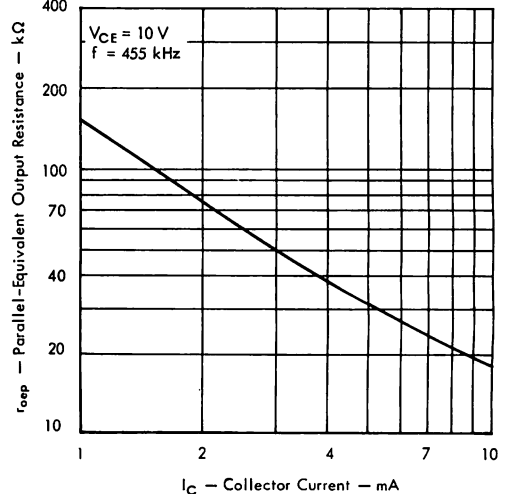

FIGURE 10

TYPES 2N4254, 2N4255, 2N4996, AND 2N4997 N-P-N EPITAXIAL PLANAR SILICON TRANSISTORS

TYPICAL CHARACTERISTICS AT 10 MHz, $T_A = 25^\circ\text{C}$

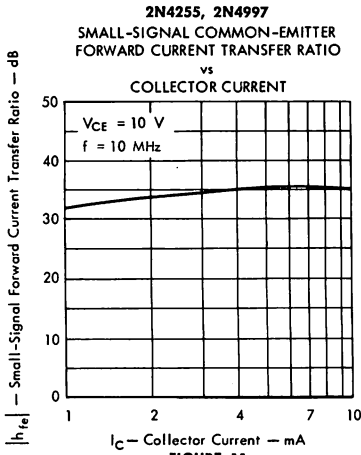

FIGURE 11

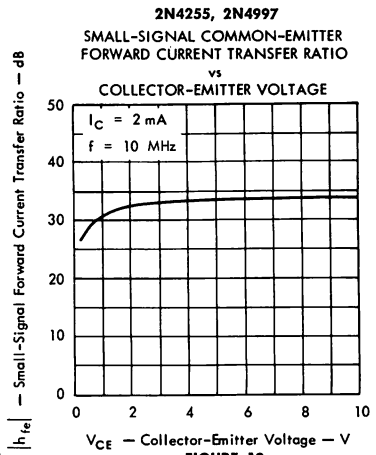

FIGURE 12

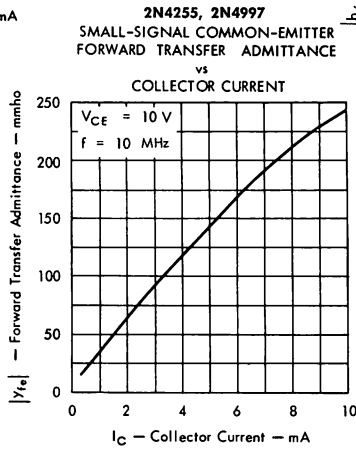

FIGURE 13

2N4255, 2N4997
PARALLEL-EQUIVALENT SMALL-SIGNAL COMMON-EMITTER
SHORT-CIRCUIT INPUT RESISTANCE

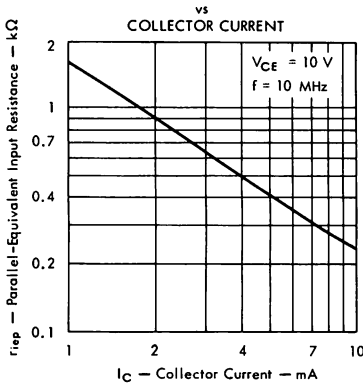

FIGURE 14

2N4255, 2N4997
PARALLEL-EQUIVALENT SMALL-SIGNAL COMMON-EMITTER
SHORT-CIRCUIT OUTPUT RESISTANCE

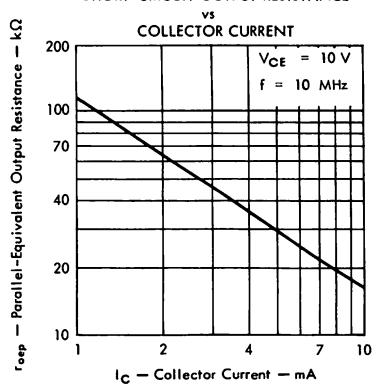

FIGURE 15

TYPES 2N4254, 2N4255, 2N4996, AND 2N4997 N-P-N EPITAXIAL PLANAR SILICON TRANSISTORS

TYPICAL CHARACTERISTICS AT 100 MHz, $T_A = 25^\circ\text{C}$

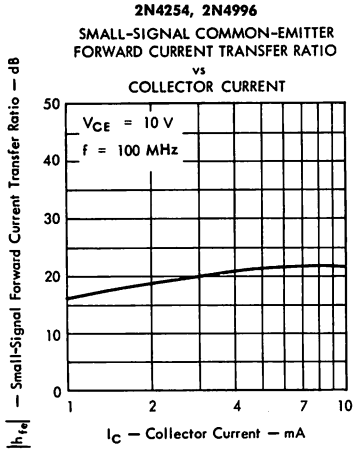

FIGURE 16

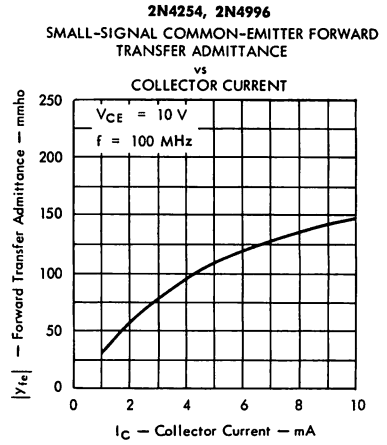

FIGURE 17

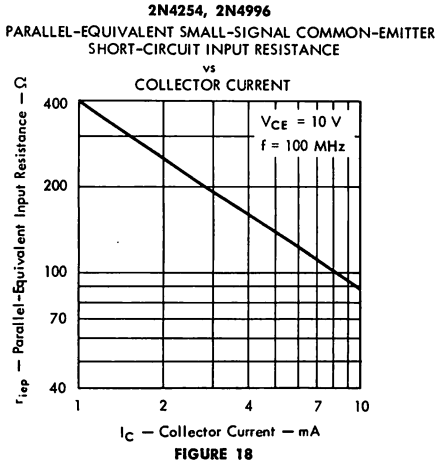

FIGURE 18

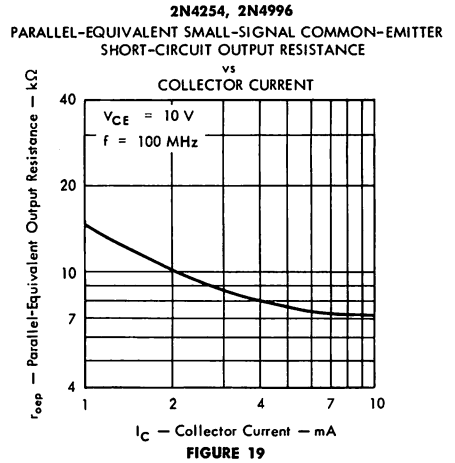
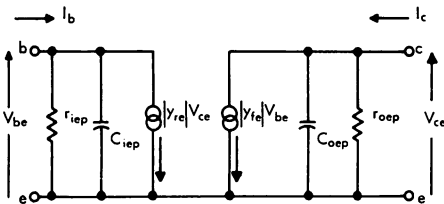

FIGURE 19

COMMON-EMITTER EQUIVALENT CIRCUIT USING SHORT-CIRCUIT "y" PARAMETERS



$$I_b = |y_{ie}| V_{be} + |y_{re}| V_{ce}$$

$$I_c = |y_{re}| V_{be} + |y_{oe}| V_{ce}$$

$$|y_{ie}| = \frac{I_b}{V_{be}} \bigg|_{V_{ce} = 0} = \frac{1}{r_{iep}} + j\omega C_{iep} \quad |y_{re}| = \frac{I_c}{V_{be}} \bigg|_{V_{ce} = 0}$$

$$|y_{re}| = \frac{I_b}{V_{ce}} \bigg|_{V_{be} = 0} \quad |y_{oe}| = \frac{I_c}{V_{ce}} \bigg|_{V_{be} = 0} = \frac{1}{r_{oep}} + j\omega C_{oep}$$

FIGURE 20

TYPES 2N4254, 2N4255, 2N4996, AND 2N4997 N-P-N EPITAXIAL PLANAR SILICON TRANSISTORS

TYPICAL APPLICATION DATA

TYPICAL FM TUNER

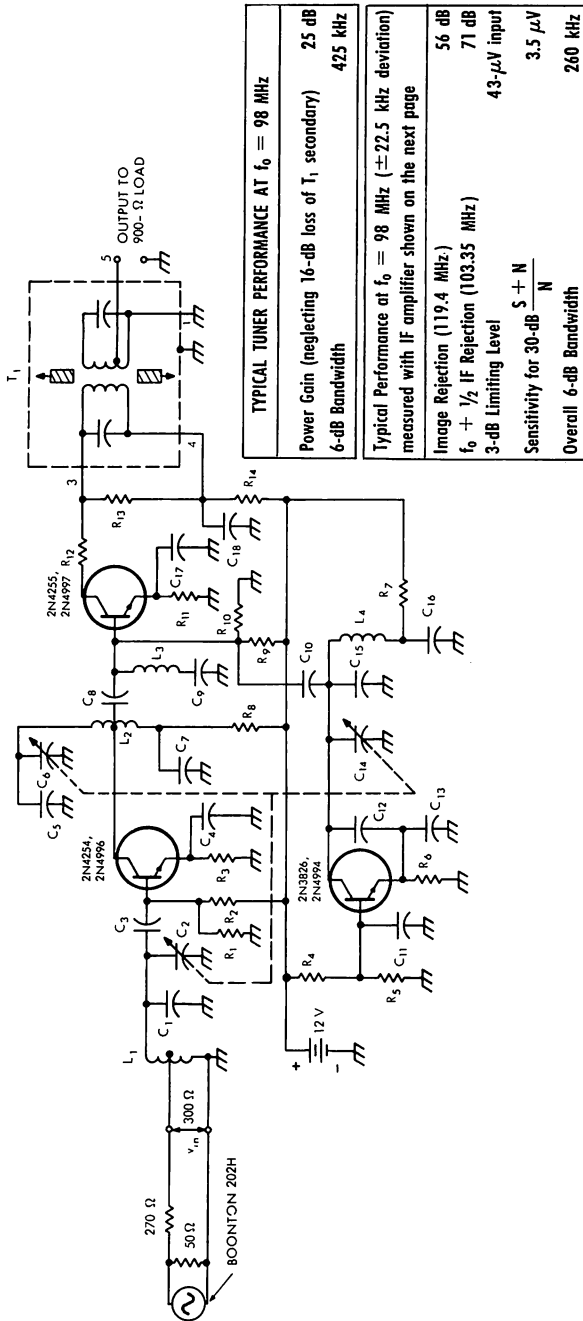

TYPICAL TUNER PERFORMANCE AT $f_0 = 98$ MHz	
Power Gain (neglecting 16-dB loss of T_1 secondary)	25 dB
6-dB Bandwidth	425 kHz
Typical Performance at $f_0 = 98$ MHz (± 22.5 kHz deviation)	
Image Rejection (119.4 MHz)	56 dB
$f_0 + 1/2$ IF Rejection (103.35 MHz)	71 dB
3-dB Limiting Level	4.3- μ V input
Sensitivity for 30-dB $\frac{S+N}{N}$	3.5 μ V
Overall 6-dB Bandwidth	260 kHz

CIRCUIT COMPONENT INFORMATION

- TRANSFORMER**
 T_1 : TRW #21157-R1 (or equivalent)
- COILS**
 L_1 : 4T #18 bus, $1/4''$ ID, $1/2''$ length, Turns Ratio 2.7:1
 L_2 : 4T #18 bus, $1/4''$ ID, $1/2''$ length, Turns Ratio 2.7:1
 L_3 : 1 μ H
 L_4 : 3T #18 bus, $5/16''$ ID, $5/8''$ length
- RESISTORS**
 R_1 : 1 k Ω
 R_2 : 4.7 k Ω
 R_3 : 1 k Ω
 R_4 : 9.1 k Ω
 R_5 : 2.7 k Ω
 R_6 : 1 k Ω
 R_7 : 330 Ω
 R_8 : 330 Ω
 R_9 : 10 k Ω
 R_{10} : 2.7 k Ω
 R_{11} : 820 Ω
 R_{12} : 470 Ω
 R_{13} : 9.1 k Ω
 R_{14} : 330 Ω
 All resistors $1/2$ W, ten percent tolerance
- CAPACITORS**
 C_1 : 10 pF
 C_2 : \dagger
 C_3 : 3.3 pF
 C_4 : 0.001 μ F
 C_5 : 10 pF
 C_6 : \dagger
 C_7 : 0.001 μ F
 C_8 : 12 pF
 C_9 : 240 pF Dura Mica
 C_{10} : 0.001 μ F
 C_{11} : 6.8 pF
 C_{12} : 4.7 pF
 C_{13} : \dagger
 C_{14} : 10 pF
 C_{15} : 0.001 μ F
 C_{16} : 0.01 μ F
 C_{17} : 0.01 μ F
 C_{18} : 0.01 μ F
 $\dagger C_5, C_6, C_{14}$: TRW #V0693, Model 57-3A, or equivalent

TYPES 2N4254, 2N4255, 2N4996, AND 2N4997 N-P-N EPITAXIAL PLANAR SILICON TRANSISTORS

TYPICAL APPLICATION DATA

TYPICAL FM PERFORMANCE	
Data taken with input on base of transistor Q ₁ IF frequency = 10.7 MHz	
1. Overall 6-dB Bandwidth (measured on base of Q ₁)	300 kHz
2. Average Power Gain per Stage	23 dB
3. FM 3-dB Limiting Level	350 μ V input
4. AM Rejection at 3-dB Limiting Level	> 30 dB
5. Maximum Audio Recovery (Full Limiting)	175 mV
6. Peak-to-Peak Separation of Ratio Detector	570 mV
700 kHz	
TYPICAL AM PERFORMANCE	
Data taken using Measurements Corporation signal generator model 65-B with a 0.05- μ F capacitor and an 82-k Ω resistor in series with generator output.	
IF frequency = 455 kHz	
1. Overall 6-dB Bandwidth	10.6 kHz
2. Overall 20-dB Bandwidth	18.6 kHz
3. Maximum Audio Output (30% Modulation)	350 mV
4. AM Sensitivity at Pin 3 of T ₆ for 20-mV Output (30% Modulation)	0.3 mV
5. AGC Figure-of-Merit	42 dB

TYPICAL AM/FM IF AMPLIFIER

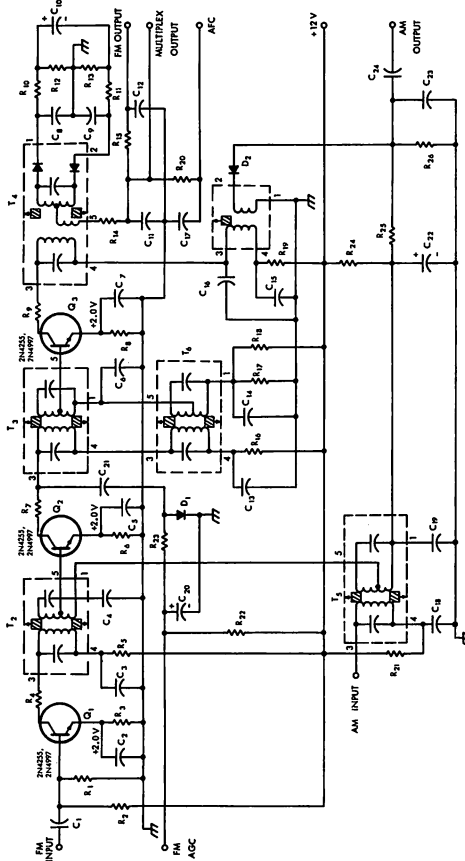

CIRCUIT COMPONENT INFORMATION

RESISTORS

R ₁ :	10 k Ω	R ₁₄ :	68 Ω
R ₂ :	33 k Ω	R ₁₅ :	7.5 k Ω
R ₃ :	1 k Ω	R ₁₆ :	330 Ω
R ₄ :	220 Ω	R ₁₇ :	2.7 k Ω
R ₅ :	330 Ω	R ₁₈ :	8.2 k Ω
R ₆ :	1 k Ω	R ₁₉ :	330 Ω
R ₇ :	220 Ω	R ₂₀ :	200 k Ω
R ₈ :	470 Ω	R ₂₁ :	330 pF
R ₉ :	1 k Ω	R ₂₂ :	33 k Ω
R ₁₀ :	1.5 k Ω	R ₂₃ :	4.7 k Ω
R ₁₁ :	1 k Ω	R ₂₄ :	82 k Ω
R ₁₂ :	8.2 k Ω	R ₂₅ :	27 k Ω
R ₁₃ :	8.2 k Ω	R ₂₆ :	3.3 k Ω

All resistors 1/2 W, ten percent tolerance

TRANSFORMERS

- T₁: Output Transformer of FM Tuner
- T₂: TRW #21158-R1 (or equivalent)
- T₃: TRW #21159-R1 (or equivalent)
- T₄: TRW #20061-R1 (or equivalent)
- T₅: TRW #21205-R1 (or equivalent)
- T₆: TRW #21204-R1 (or equivalent)
- T₇: TRW #18304-R1 (or equivalent)

DIODES

- D₁: 1N4531
- D₂: 1N295

CAPACITORS

C ₁ :	0.02 μ F	C ₁₃ :	0.05 μ F
C ₂ :	0.01 μ F	C ₁₄ :	0.05 μ F
C ₃ :	0.01 μ F	C ₁₅ :	0.05 μ F
C ₄ :	0.001 μ F	C ₁₆ :	0.0015 μ F
C ₅ :	0.05 μ F	C ₁₇ :	0.05 μ F
C ₆ :	0.001 μ F	C ₁₈ :	0.05 μ F
C ₇ :	0.001 μ F	C ₁₉ :	0.05 μ F
C ₈ :	330 pF	C ₂₀ :	5 μ F, 10 V, electrolytic
C ₉ :	330 pF	C ₂₁ :	6.8 pF
C ₁₀ :	2 μ F, 10 V, electrolytic	C ₂₂ :	5 μ F, 10 V, electrolytic
C ₁₁ :	330 pF	C ₂₃ :	0.05 μ F
C ₁₂ :	0.01 μ F	C ₂₄ :	5 μ F, 15 V, electrolytic, Polarity determined by following stage

TYPES 2N4418 AND 2N4419 N-P-N EPITAXIAL PLANAR SILICON TRANSISTORS



TYPES 2N4418 AND 2N4419
BULLETIN NO. DL-5 689126, SEPTEMBER 1965
REVISED MAY 1968

SILECT† TRANSISTORS FOR HIGH-SPEED SWITCHING APPLICATIONS

- 2N4418 Electrically Similar to the 2N2369
- Rugged, One-Piece Construction with Standard T0-18 100-mil Pin Circle

mechanical data

These transistors are encapsulated in a plastic compound specifically designed for this purpose, using a highly mechanized process‡ developed by Texas Instruments. The case will withstand soldering temperatures without deformation. These devices exhibit stable characteristics under high-humidity conditions and are capable of meeting MIL-STD-202C method 106B. The transistors are insensitive to light.

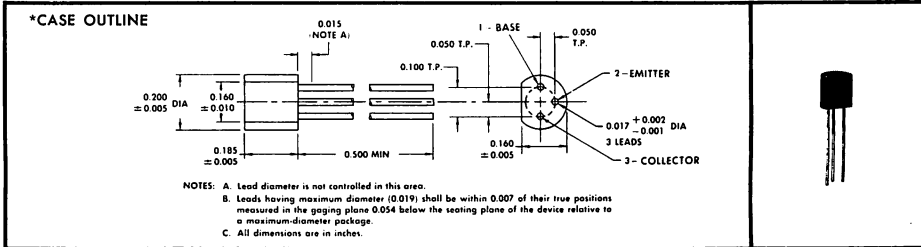

*absolute maximum ratings at 25°C free-air temperature (unless otherwise noted)

	2N4418	2N4419
Collector-Base Voltage	40 V	30 V
Collector-Emitter Voltage (See Note 1)	40 V	30 V
Collector-Emitter Voltage (See Note 2)	15 V	12 V
Emitter-Base Voltage	4.5 V	4.5 V
Continuous Collector Current	← 200 mA →	
Peak Collector Current (See Note 3)	← 500 mA →	
Continuous Device Dissipation at (or below) 25°C Free-Air Temperature (See Note 4)	← 360 mW →	
Continuous Device Dissipation at (or below) 25°C Lead Temperature (See Note 5)	← 500 mW →	
Storage Temperature Range	← -65°C to 150°C →	
Lead Temperature 1/16 Inch from Case for 10 Seconds	← 260°C →	

*electrical characteristics at 25°C free-air temperature (unless otherwise noted)

PARAMETER	TEST CONDITIONS	2N4418		2N4419		UNIT
		MIN	MAX	MIN	MAX	
$V_{(BR)CBO}$ Collector-Base Breakdown Voltage	$I_C = 10 \mu A, I_E = 0$	40		30		V
$V_{(BR)CEO}$ Collector-Emitter Breakdown Voltage	$I_C = 10 \text{ mA}, I_B = 0$, See Note 6	15		12		V
$V_{(BR)CES}$ Collector-Emitter Breakdown Voltage	$I_C = 10 \mu A, V_{BE} = 0$	40		30		V
$V_{(BR)EBO}$ Emitter-Base Breakdown Voltage	$I_E = 10 \mu A, I_C = 0$	4.5		4.5		V
I_{CBO} Collector Cutoff Current	$V_{CB} = 20 \text{ V}, I_E = 0$		0.4		0.4	μA
	$V_{CB} = 20 \text{ V}, I_E = 0, T_A = 70^\circ C$		3		3	μA
I_{EBO} Emitter Cutoff Current	$V_{EB} = 3 \text{ V}, I_C = 0$		20		25	nA
h_{FE} Static Forward Current Transfer Ratio	$V_{CE} = 1 \text{ V}, I_C = 10 \text{ mA}$, See Note 6	40	120	30		
	$V_{CE} = 2 \text{ V}, I_C = 100 \text{ mA}$, See Note 6	20				
V_{BE} Base-Emitter Voltage	$I_B = 1 \text{ mA}, I_C = 10 \text{ mA}$	0.72	0.87	0.72	0.87	V
$V_{CE(sat)}$ Collector-Emitter Saturation Voltage	$I_B = 1 \text{ mA}, I_C = 10 \text{ mA}$		0.25		0.25	V
$ h_{fe} $ Small-Signal Common-Emitter Forward Current Transfer Ratio	$V_{CE} = 10 \text{ V}, I_C = 10 \text{ mA}, f = 100 \text{ MHz}$	5		4		
C_{cb} Collector-Base Capacitance	$V_{CB} = 5 \text{ V}, I_E = 0, f = 1 \text{ MHz}$, See Note 7		4		4	pF

NOTES: 1. This value applies when the base-emitter diode is short-circuited.

2. These values apply between 0 and 200 mA collector current when the base-emitter diode is open-circuited. Maximum rated voltage and 200 mA collector current may be simultaneously applied provided the time of application is 10 μs or less and the duty cycle is 2% or less.

3. This value applies for $I_B \leq 10 \mu s$ and duty cycle $\leq 2\%$.

4. Derate linearly to 150°C free-air temperature at the rate of 2.88 mW/deg.

5. Derate linearly to 150°C lead temperature at the rate of 4 mW/deg. Lead temperature is measured on the collector lead 1/16 inch from the case.

6. These parameters must be measured using pulse techniques. $t_p = 300 \mu s$, duty cycle $\leq 2\%$.

7. C_{cb} is measured using three-terminal measurement techniques with the emitter guarded.

*Indicates JEDEC registered data

†Trademark of Texas Instruments

‡Patent Pending



TEXAS INSTRUMENTS
INCORPORATED
POST OFFICE BOX 5012 • DALLAS, TEXAS 75222

TYPES 2N4418 AND 2N4419

N-P-N EPITAXIAL PLANAR SILICON TRANSISTORS

*switching characteristics at 25°C free-air temperature

PARAMETER	TEST CONDITIONS†	2N4418	2N4419	UNIT
		MAX	MAX	
t_d Delay Time	$I_C = 10 \text{ mA}$, $I_{B(1)} = 1 \text{ mA}$, $V_{BE(off)} = 0$, See Figure 1	10	10	ns
t_r Rise Time		12	14	ns
t_{on} Turn-on Time		20	22	ns
t_s Storage Time	$I_C = 10 \text{ mA}$, $I_{B(1)} = 1 \text{ mA}$, $I_{B(2)} = -1 \text{ mA}$, $R_L = 280 \Omega$, See Figure 2	12	14	ns
t_f Fall Time		14	16	ns
t_{off} Turn-off Time		22	28	ns
t_s Storage Time	$I_C = 10 \text{ mA}$, $I_{B(1)} = 10 \text{ mA}$, $I_{B(2)} = -10 \text{ mA}$, See Figure 3	18	20	ns

†Voltage and current values shown are nominal; exact values vary slightly with transistor parameters.

*PARAMETER MEASUREMENT INFORMATION

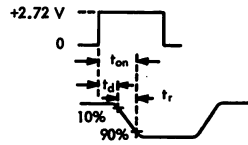
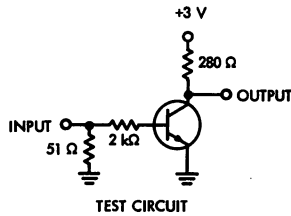

FIGURE 1

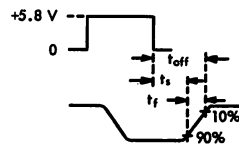
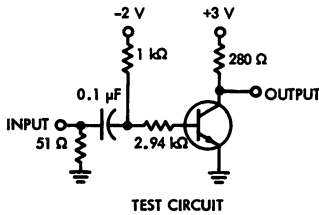

FIGURE 2

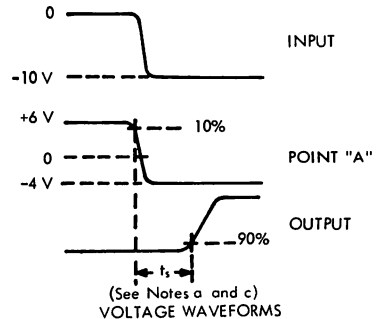
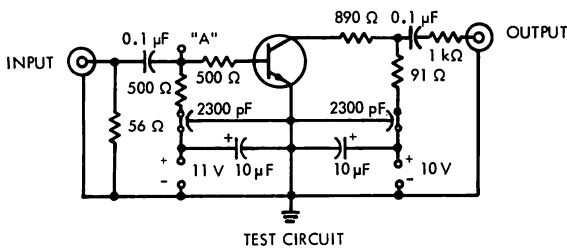

FIGURE 3

- NOTES: a. The input waveforms are supplied by a generator with the following characteristics: $Z_{out} = 50 \Omega$, $t_r \leq 1 \text{ ns}$, $t_p \geq 200 \text{ ns}$, duty cycle $\leq 2\%$.
 b. Waveforms of figures 1 and 2 are monitored on an oscilloscope with the following characteristics: $t_r \leq 1 \text{ ns}$, $R_{in} \geq 100 \text{ k}\Omega$, $C_{in} \leq 10 \text{ pF}$.
 c. Output waveform of figure 3 is monitored on an oscilloscope with the following characteristics: $t_r \leq 1 \text{ ns}$, $Z_{in} = 50 \Omega$.

*Indicates JEDEC registered data

TYPES 2N4420, 2N4421 N-P-N EPITAXIAL PLANAR SILICON TRANSISTORS



TYPES 2N4420, 2N4421
BULLETIN NO. DLS-68913Z
REVISED MAY 1968

SILECT† TRANSISTORS FOR HIGH-SPEED SWITCHING APPLICATIONS

- 2N4420 Electrically Similar to the 2N3014
- Rugged, One-Piece Construction with Standard TO-18 100-mil Pin Circle

mechanical data

These transistors are encapsulated in a plastic compound specifically designed for this purpose, using a highly mechanized process‡ developed by Texas Instruments. The case will withstand soldering temperatures without deformation. These devices exhibit stable characteristics under high-humidity conditions and are capable of meeting MIL-STD-202C method 106B. The transistors are insensitive to light.

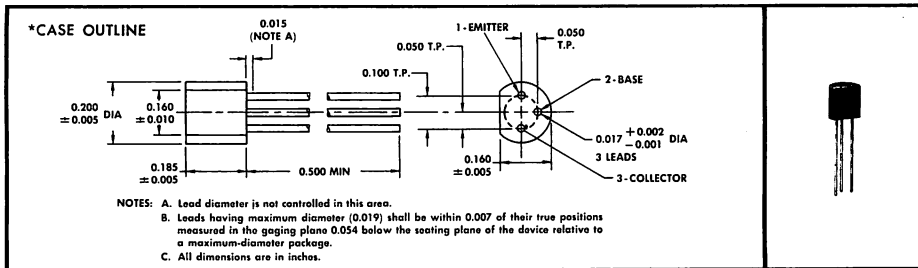

*absolute maximum ratings at 25°C free-air temperature (unless otherwise noted)

	2N4420	2N4421
Collector-Base Voltage	40 V	30 V
Collector-Emitter Voltage (See Note 1)	40 V	30 V
Collector-Emitter Voltage (See Note 2)	20 V	12 V
Emitter-Base Voltage	5 V	5 V
Continuous Collector Current	← 200 mA →	
Peak Collector Current (See Note 3)	← 500 mA →	
Continuous Device Dissipation at (or below) 25°C Free-Air Temperature (See Note 4)	← 360 mW →	
Continuous Device Dissipation at (or below) 25°C Lead Temperature (See Note 5)	← 500 mW →	
Storage Temperature Range	-65°C to 150°C*	
Lead Temperature 1/16 Inch from Case for 10 Seconds	← 260°C →	

- NOTES: 1. This value applies when the base-emitter diode is short-circuited.
2. This value applies between 0 and 200 mA collector current when the base-emitter diode is open-circuited. Maximum rated voltage and 200 mA collector current may be simultaneously applied provided the time of application is 10 μs or less and the duty cycle is 2% or less.
3. This value applies for $t_p \leq 10 \mu s$ and duty cycle $\leq 2\%$.
4. Derate linearly to 150°C free-air temperature at the rate of 2.88 mW/deg.
5. Derate linearly to 150°C lead temperature at the rate of 4 mW/deg. Lead temperature is measured on the collector lead 1/16 inch from the case.
- *Indicates JEDEC registered data
†Trademark of Texas Instruments
‡Patent Pending

TYPES 2N4420, 2N4421

N-P-N EPITAXIAL PLANAR SILICON TRANSISTORS

*electrical characteristics at 25°C free-air temperature (unless otherwise noted)

PARAMETER	TEST CONDITIONS	2N4420		2N4421		UNIT
		MIN	MAX	MIN	MAX	
$V_{(BR)CBO}$ Collector-Base Breakdown Voltage	$I_C = 100 \mu A, I_E = 0$	40		30		V
$V_{(BR)CEO}$ Collector-Emitter Breakdown Voltage	$I_C = 10 \text{ mA}, I_B = 0$, See Note 6	20		12		V
$V_{(BR)CES}$ Collector-Emitter Breakdown Voltage	$I_C = 100 \mu A, V_{BE} = 0$	40		30		V
$V_{(BR)EBO}$ Emitter-Base Breakdown Voltage	$I_E = 100 \mu A, I_C = 0$	5		5		V
I_{CES} Collector Cutoff Current	$V_{CE} = 20 \text{ V}, V_{BE} = 0$		0.5		0.5	μA
	$V_{CE} = 20 \text{ V}, V_{BE} = 0, T_A = 70^\circ C$		4		4	μA
I_{EBO} Emitter Cutoff Current	$V_{EB} = 3 \text{ V}, I_C = 0$		20		100	nA
h_{FE} Static Forward Current Transfer Ratio	$V_{CE} = 0.4 \text{ V}, I_C = 10 \text{ mA}$		25			
	$V_{CE} = 0.4 \text{ V}, I_C = 30 \text{ mA}$		30 120		25	
	$V_{CE} = 1 \text{ V}, I_C = 100 \text{ mA}$		25			
V_{BE} Base-Emitter Voltage	$I_B = 1 \text{ mA}, I_C = 10 \text{ mA}$		0.7 0.8			V
	$I_B = 3 \text{ mA}, I_C = 30 \text{ mA}$		0.75 0.95		0.75 0.95	V
	$I_B = 10 \text{ mA}, I_C = 100 \text{ mA}$		1.2			V
$V_{CE(sat)}$ Collector-Emitter Saturation Voltage	$I_B = 1 \text{ mA}, I_C = 10 \text{ mA}$		0.2			V
	$I_B = 3 \text{ mA}, I_C = 30 \text{ mA}$		0.2		0.2	V
	$I_B = 10 \text{ mA}, I_C = 100 \text{ mA}$		0.35			V
	$I_B = 3 \text{ mA}, I_C = 30 \text{ mA}, T_A = 70^\circ C$		0.25			V
$ h_{fe} $ Small-Signal Common-Emitter Forward Current Transfer Ratio	$V_{CE} = 5 \text{ V}, I_C = 30 \text{ mA}, f = 100 \text{ MHz}$	3.5		3		
C_{cb} Collector-Base Capacitance	$V_{CB} = 5 \text{ V}, I_E = 0, f = 1 \text{ MHz}$, See Note 7		5		5	pF
C_{eb} Emitter-Base Capacitance	$V_{EB} = 0.5 \text{ V}, I_C = 0, f = 1 \text{ MHz}$, See Note 7		8		8	pF

NOTES: 6. These parameters must be measured using pulse techniques. $t_p = 300 \mu s$, duty cycle $\leq 2\%$.

7. C_{cb} and C_{eb} are measured using three-terminal measurement techniques with the third electrode (emitter or collector respectively) guarded.

*Indicates JEDEC registered data

TYPES 2N4420 , 2N4421

N-P-N EPITAXIAL PLANAR SILICON TRANSISTORS

*switching characteristics at 25°C free-air temperature

PARAMETER	TEST CONDITIONS†	2N4420	2N4421	UNIT
		MAX	MAX	
t_d Delay Time	$I_C = 30 \text{ mA}$, $I_{B(1)} = 3 \text{ mA}$, $R_L = 93 \Omega$, $V_{BE(off)} = 0$, See Figure 1	8	10	ns
t_r Rise Time		10	12	ns
t_{on} Turn-on Time		16	18	ns
t_s Storage Time	$I_C = 30 \text{ mA}$, $I_{B(1)} = 3 \text{ mA}$, $R_L = 93 \Omega$, $I_{B(2)} = -3 \text{ mA}$, See Figure 2	15	18	ns
t_f Fall Time		10	12	ns
t_{off} Turn-off Time		20	24	ns
t_s Storage Time	$I_C = 10 \text{ mA}$, $I_{B(1)} = 10 \text{ mA}$, $I_{B(2)} = -10 \text{ mA}$, See Figure 3	20		ns

†Voltage and current values shown are nominal; exact values vary slightly with transistor parameters.

*PARAMETER MEASUREMENT INFORMATION

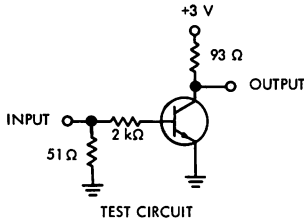

FIGURE 1

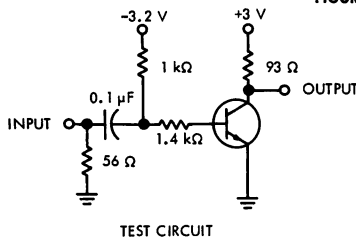
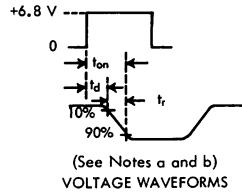

FIGURE 2

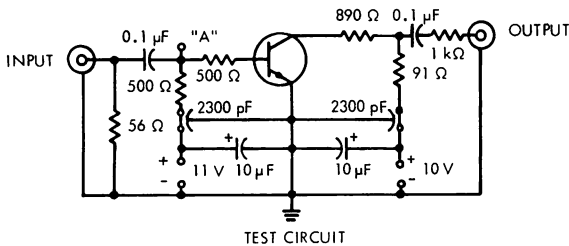
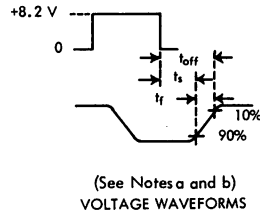
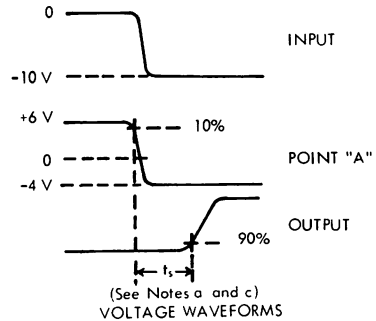

FIGURE 3



- NOTES: a. The input waveforms are supplied by a generator with the following characteristics: $Z_{out} = 50 \Omega$, $t_r \leq 1 \text{ ns}$, $t_p \geq 200 \text{ ns}$, duty cycle $\leq 2\%$.
 b. Waveforms of figures 1 and 2 are monitored on an oscilloscope with the following characteristics: $t_r \leq 1 \text{ ns}$, $R_{in} \geq 100 \text{ k}\Omega$, $C_{in} \leq 10 \text{ pF}$.
 c. Output waveform of figure 3 is monitored on an oscilloscope with the following characteristics: $t_r \leq 1 \text{ ns}$, $Z_{in} = 50 \Omega$.

*Indicates JEDEC registered data

TI Microlibrary Books for Creative Circuit Designers

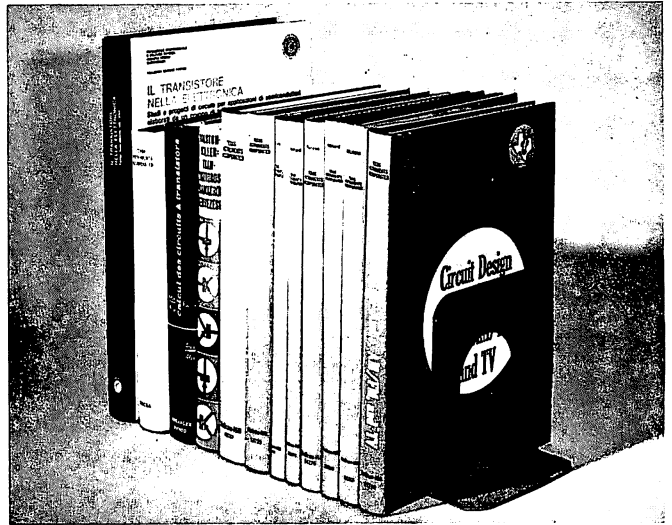

TRANSISTOR CIRCUIT DESIGN

523 Pages • 526 Illustrations • Published January '63 •
Shipping Weight 3-lb 4 oz • \$15.00

FIELD-EFFECT TRANSISTORS • L. J. SEVIN

138 Pages • 137 Illustrations • Published April '65 •
Shipping Weight 1-lb 10-oz • \$10.00

MOSFET IN CIRCUIT DESIGN • ROBERT H. CRAWFORD

136 Pages • 100 Illustrations • Published May '67 •
Shipping Weight 1-lb 10-oz • \$10.00

CIRCUIT DESIGN FOR AUDIO, AM/FM AND TV

352 Pages • 145 Illustrations • Published February '67 •
Shipping Weight 2-lb 8-oz • \$14.50

SILICON SEMICONDUCTOR TECHNOLOGY • W. R. RUNYAN

256 Pages • 301 Illustrations • Published May '65 •
Shipping Weight 2-lb 9-oz • \$16.50

DESIGN AND APPLICATION OF TRANSISTOR SWITCHING CIRCUITS • LOUIS DELHOM

278 Pages • 315 Illustrations • Published January '68 •
Shipping Weight 2-lb • \$14.50

SOLID STATE COMMUNICATIONS

366 Pages • 417 Illustrations • Published April '66 •
Shipping Weight 2-lb 9-oz • \$12.50

SOLID STATE ELECTRONICS • ROBERT G. HIBBERD

170 Pages • 90 Illustrations • Published January '68 •
Shipping Weight 1-lb 12-oz • \$8.95

Terms: F.O.B. destination, bulk rate.
Other than bulk rate,
indicate method of shipment,
add shipping charges.

Outside U.S.: Indicate method of shipment,
add shipping charges.

Send check or money order
(no purchase orders) to:

EXECUTIVE SERVICES DISTRIBUTION
Suite 148
8383 Stemmons Freeway
Dallas, Texas 75247

TYPES 2N5449, 2N5450, 2N5451 N-P-N EPITAXIAL PLANAR SILICON TRANSISTORS



TYPES 2N5449, 2N5450, 2N5451
BULLETIN NO. DL-5 6810924 MAY 1968

SILECT† TRANSISTORS

Encapsulated in Plastic for Such Applications as
Medium-Power Amplifiers, Class B Audio Outputs, and Hi-Fi Drivers

- Electrically Equivalent to 2N3704, 2N3705, and 2N3706
- For Complementary Use with 2N5447 and 2N5448
- Rugged, One-Piece Construction Features Standard 100-mil TO-18 Pin Circle

mechanical data

These transistors are encapsulated in a plastic compound specifically designed for this purpose, using a highly mechanized process‡ developed by Texas Instruments. The case will withstand soldering temperatures without deformation. These devices exhibit stable characteristics under high-humidity conditions and are capable of meeting MIL-STD-202C method 106B. The transistors are insensitive to light.

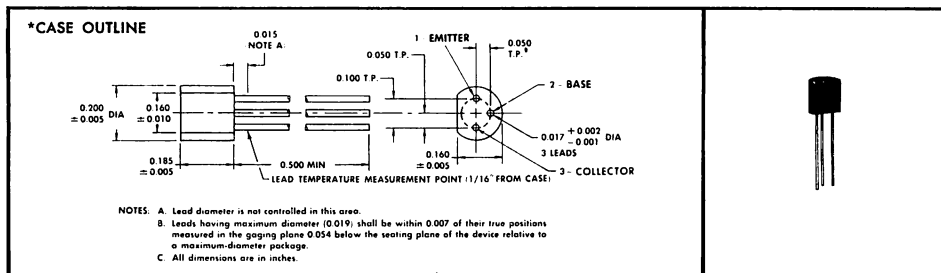

*absolute maximum ratings at 25°C free-air temperature (unless otherwise noted)

	2N5449 2N5450	2N5451
Collector-Base Voltage	50 V	40 V
Collector-Emitter Voltage (See Note 1)	30 V	20 V
Emitter-Base Voltage	5 V	5 V
Continuous Collector Current	← 800 mA →	
Continuous Device Dissipation at (or below) 25°C Free-Air Temperature (See Note 2)	← 360 mW →	
Continuous Device Dissipation at (or below) 25°C Lead Temperature (See Note 3)	← 500 mW →	
Storage Temperature Range	-65°C to 150°C	
Lead Temperature 1/16 Inch from Case for 10 Seconds	← 260°C →	

- NOTES: 1. These values apply when the base-emitter diode is open-circuited.
2. Derate linearly to 150°C free-air temperature at the rate of 2.88 mW/deg.
3. Derate linearly to 150°C lead temperature at the rate of 4 mW/deg. Lead temperature is measured on the collector lead 1/16 inch from the case.

†Trademark of Texas Instruments
‡Patent pending
*Indicates JEDEC registered data



TEXAS INSTRUMENTS
INCORPORATED
POST OFFICE BOX 5012 • DALLAS, TEXAS 75222

TYPES 2N5449, 2N5450, 2N5451

N-P-N EPITAXIAL PLANAR SILICON TRANSISTORS

*electrical characteristics at 25°C free-air temperature

PARAMETER	TEST CONDITIONS	2N5449		2N5450		2N5451		UNIT
		MIN	MAX	MIN	MAX	MIN	MAX	
$V_{(BR)CBO}$ Collector-Base Breakdown Voltage	$I_C = 100 \mu A, I_E = 0$	50		50		40		V
$V_{(BR)CEO}$ Collector-Emitter Breakdown Voltage	$I_C = 10 \text{ mA}, I_B = 0$, See Note 4	30		30		20		V
$V_{(BR)EBO}$ Emitter-Base Breakdown Voltage	$I_E = 100 \mu A, I_C = 0$	5		5		5		V
I_{CBO} Collector Cutoff Current	$V_{CB} = 20 \text{ V}, I_E = 0$		100		100		100	nA
I_{EBO} Emitter Cutoff Current	$V_{EB} = 3 \text{ V}, I_C = 0$		100		100		100	nA
h_{FE} Static Forward Current Transfer Ratio	$V_{CE} = 2 \text{ V}, I_C = 50 \text{ mA}$, See Note 4	100	300	50	150	30	600	
V_{BE} Base-Emitter Voltage	$V_{CE} = 2 \text{ V}, I_C = 100 \text{ mA}$, See Note 4	0.5	1	0.5	1	0.5	1	V
$V_{CE(sat)}$ Collector-Emitter Saturation Voltage	$I_B = 5 \text{ mA}, I_C = 100 \text{ mA}$, See Note 4		0.6		0.8		1	V
$ h_{fe} $ Small-Signal Common-Emitter Forward Current Transfer Ratio	$V_{CE} = 2 \text{ V}, I_C = 50 \text{ mA}$, $f = 20 \text{ MHz}$		5		5		5	
C_{cb} Collector-Base Capacitance	$V_{CB} = 10 \text{ V}, I_E = 0$, $f = 1 \text{ MHz}$, See Note 5		12		12		12	pF

NOTES: 4. These parameters must be measured using pulse techniques. $t_p = 300 \mu s$, duty cycle $\leq 2\%$.

5. C_{cb} is measured using three-terminal measurement techniques with the emitter guarded.

*Indicates JEDEC registered data

TYPICAL CHARACTERISTICS

2N5450

STATIC FORWARD CURRENT TRANSFER RATIO
vs
COLLECTOR CURRENT

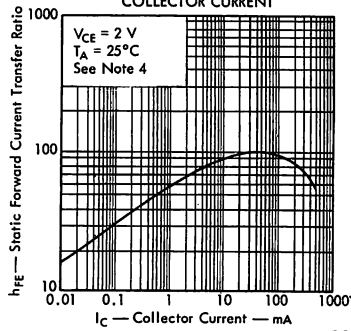

BASE-EMITTER VOLTAGE
vs
COLLECTOR CURRENT

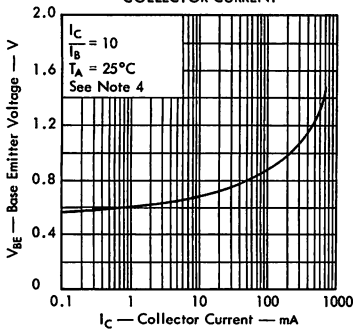

COLLECTOR-EMITTER SATURATION VOLTAGE
vs
COLLECTOR CURRENT

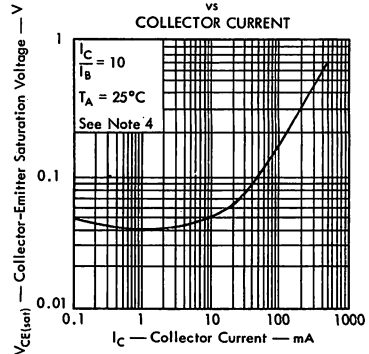

TYPES 2N5449, 2N5450, 2N5451 N-P-N EPITAXIAL PLANAR SILICON TRANSISTORS

TYPICAL APPLICATION DATA

SILICON 15-WATT QUASI-COMPLEMENTARY POWER AMPLIFIER

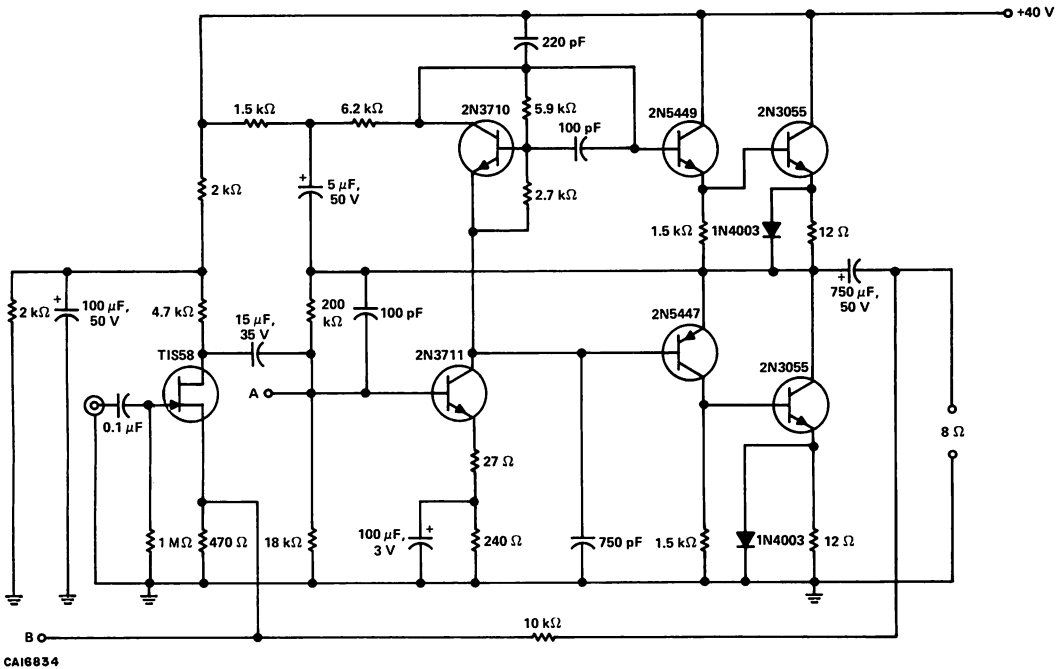

TYPICAL PERFORMANCE SPECIFICATIONS

Continuous Output Power	15 W @ 0.15% THD
Power Bandwidth @ 7.5 W	20 Hz – 20 kHz
Frequency Response ± 0.5 dB	10 Hz – 50 kHz
Total Harmonic Distortion @ 7.5 W	0.06%
Intermodulation Distortion @ 7.5 W	0.15%
Sensitivity @ 15 W	850 mV
Input Impedance	1 M Ω
Hum and Noise: "C" Weighting	
Input Shorted	-95 dB
Input Open	-85 dB
Damping Factor	48

AUTHORIZED DISTRIBUTORS

FOR TEXAS INSTRUMENTS COMPONENTS GROUP

ALABAMA

ACK SEMICONDUCTORS INC.
3101 Fourth Ave. South/(205) FA 2-0588
Birmingham, Alabama 35233

ELECTRONIC WHOLESALERS, INC.
2310 Bob Wallace Avenue, S.W.
(205) 534-2461
Huntsville, Alabama 35805

ARIZONA

KIERULFF ELECTRONICS, INC.
2633 East Buckeye Road
(602) 273-7331
Phoenix, Arizona 85034

R. V. WEATHERFORD COMPANY
1917 North 25 Drive/(602) 272-7144
Carson Industrial Center
Phoenix, Arizona

CALIFORNIA

CALIFORNIA ELECTRONICS SUPPLY, INC.
1911 Armacost Avenue/(213) TR 9-0760
West Los Angeles, California 90025

KIERULFF ELECTRONICS, INC.
3969 E. Bayshore/(415) 968-6292
Palo Alto, California 94303

MILO OF CALIFORNIA
2060 India St./(714) BE 2-8951
San Diego, California 92101

RADIO PRODUCTS SALES, INC.
1501 S. Hill St./(213) RI 8-1271
Los Angeles, California 90015

R. V. WEATHERFORD COMPANY
1651 S. State College Blvd.
(714) KI 7-7521
Anaheim, California 92805
6921 San Fernando Rd./(213) VI 9-3451
Glendale, California 91201
3240 Hillview Drive
Stanford Industrial Park
(415) DA 1-5373
Palo Alto, California 94304

TI SUPPLY COMPANY
1651 Tenth Street/(213) 393-6731
Santa Monica, California 90404

COLORADO

TI SUPPLY COMPANY
2186 S. Holly/(303) 757-7671
Denver, Colorado 80222

FLORIDA

ELECTRONIC WHOLESALERS, INC.
345 Graham Ave./(305) 841-1550
Orlando, Florida 32814

9390 N. W. 27th Ave./(305) OX 6-1620
Miami, Florida 33147

ILLINOIS

ALLIED ELECTRONICS CORPORATION
100 N. Western Ave./(312) TA 9-9100
Chicago, Illinois 60680

MERQUIP ELECTRONICS, INC.
7701 No. Austin Ave./(312) 965-7500
Skokie, Illinois 60076

NEWARK ELECTRONICS CORP.
500 N. Pulaski Road/(312) 638-4411
Chicago, Illinois 60624

TI SUPPLY COMPANY
7135 N. Barry Avenue/(312) 296-7187
Des Plaines, Illinois 60018

INDIANA

ESCO ELECTRONICS INC.
2442 N. Shadeland Ave./(317) 357-8791
Indianapolis, Indiana 46219

RADIO DISTRIBUTING COMPANY
814 North Senate Avenue
(317) 637-5571
Indianapolis, Indiana 46204

IOWA

DEECO, INC.
618 First St., N. W./(319) EM 5-7551
Cedar Rapids, Iowa 52405

LOUISIANA

ELECTRONIC PRODUCTS CORPORATION
3622 Toulouse St./(504) HU 6-3777
New Orleans, Louisiana 70119

MARYLAND

ELECTRONIC WHOLESALERS, INC.
3200 Wilkens Ave./(301) 646-3600
Baltimore, Maryland 21223

MILGRAY/WASHINGTON
5405 Lafayette Place/(202) 864-1111
Hyattsville, Maryland 20781

MASSACHUSETTS

DEMAMBRO ELECTRONICS
1095 Commonwealth Ave.
(617) 787-1200
Boston, Massachusetts 02215

TI SUPPLY COMPANY
480 Neponset Road/(617) 828-5020
Canton, Massachusetts 02021

LAFAYETTE INDUSTRIAL ELECTRONICS
1400 Worcester Rd./(617) 969-6100
Natick, Massachusetts 01760

MILGRAY/NEW ENGLAND INC.
75 Terrace Hall Avenue/(617) 272-6800
Burlington, Massachusetts 02021

MICHIGAN

NEWARK-DETROIT ELECTRONICS, INC.
20700 Hubbell Ave./(313) 548-0250
Detroit, Michigan 48237

NEWARK-INDUSTRIAL
ELECTRONICS CORP.
2114 So. Division/(616) CH 1-5695
Grand Rapids, Michigan 49507

MINNESOTA

STARK ELECTRONIC SUPPLY CO.
112 Third Avenue N./(612) FE 2-1325
Minneapolis, Minnesota 55401

MISSOURI

TI SUPPLY COMPANY
2916 Holmes Street/(816) 753-4750
Kansas City, Missouri 64109

ELECTRONIC COMPONENTS FOR
INDUSTRY
2605 South Hanley Rd./(314) MI 7-5505
St. Louis, Missouri 63144

NEW JERSEY

GENERAL RADIO SUPPLY COMPANY, INC.
600 Penn St./(609) WO 4-8560
Camden, New Jersey 08102

TI SUPPLY COMPANY
301 Central Ave./(201) 382-6400
Clark, N. J. 07066

NEW MEXICO

KIERULFF ELECTRONICS, INC.
2524 Baylor Dr. S.E./(505) 247-1055
Albuquerque, New Mexico 87108

NEW YORK

GENESEE RADIO & PARTS CO., INC.
2550 Delaware Ave./(716) TR 3-9661
Buffalo, New York 14216

LAFAYETTE INDUSTRIAL ELECTRONICS
165-08 Liberty Ave./(212) 658-5050
Jamaica, New York 11431

MILGRAY/NEW YORK
160 Varick St./(212) YU 9-1600
New York, New York 10013

ROCHESTER RADIO SUPPLY CO., INC.
140 W. Main St./(716) 454-7800
Rochester, New York 14614

TI SUPPLY COMPANY
4 Nevada Dr./(516) 488-3300
New Hyde Park, N. Y. 11040

NORTH CAROLINA

ELECTRONIC WHOLESALERS, INC.
938 Burke St./(919) PA 5-8711
Winston-Salem, North Carolina 27101

OHIO

ESCO ELECTRONICS INC.
3130 Valleywood Drive/(513) 298-0191
Dayton, Ohio 45429

MILGRAY/CLEVELAND
1821 East 40th Street/(216) 881-8800
Cleveland, Ohio 44102

NEWARK-HERRLINGER
ELECTRONICS CORP.
112 E. Liberty St./(513) GA 1-5282
Cincinnati, Ohio 45210

W. M. PATTISON SUPPLY CO.
4550 Willow Parkway/(216) 441-3000
Cleveland, Ohio 44125

SREPCO ELECTRONICS, INC.
314 Leo Street/(513) BA 4-3871
Dayton, Ohio 45404

OKLAHOMA

TI SUPPLY COMPANY
12151 E. Skelly Dr./(918) 437-4555
Tulsa, Oklahoma 74110

OREGON

ALMAC STROUM ELECTRONICS
CORPORATION
8888 S.W. Canyon Road/(503) 292-3534
Portland, Oregon 97225

PENNSYLVANIA

MILGRAY/DELAWARE VALLEY INC.
2532 N. Broad St./(215) BA 8-2000
Philadelphia, Penn. 19107

RPC ELECTRONICS
620 Alpha Dr./(412) 782-3770
RDC Park
Pittsburgh, Pennsylvania 15238

TEXAS

TI SUPPLY COMPANY
6000 Denton Drive/(214) FL 7-6121
Dallas, Texas 75235

5240 Elm Street/(713) MO 6-2175
Houston, Texas 77036

HARRISON EQUIPMENT COMPANY, INC.
1422 San Jacinto St./(713) CA 4-9131
Houston, Texas 77001

MIDLAND SPECIALTY COMPANY
2235 Wyoming Ave./(915) KE 3-9555
El Paso, Texas 79903

UTAH

STANDARD SUPPLY COMPANY
225 E. Sixth South St./(801) EL 5-2971
Salt Lake City, Utah 84110

WASHINGTON

ALMAC-STROUM ELECTRONICS
5811 Sixth Ave. So./(206) 763-2300
Seattle, Washington 98108

WASHINGTON, D.C.

ELECTRONIC WHOLESALERS, INC.
2345 Sherman Ave., N. W.
(202) HU 3-5200
Washington, D.C. 20001

CANADA

CANADIAN ELECTRONICS LTD.
Calgary, Alberta
Edmonton, Alberta
Lethbridge, Alberta
Medicine Hat, Alberta
Vancouver, B. C.

CESCO ELECTRONICS LTD.
Downsview, Quebec
Quebec, Quebec
Ottawa, Ontario
Toronto, Ontario
TI SUPPLY COMPANY
Dorval, Quebec

WELLINGTON, New Zealand
W. G. LEATHAM LTD.

AUSTRALIAN TI DISTRIBUTOR

MELBOURNE, Australia
RADIO PARTS PTY, LTD.
PERTH, Australia
PRECISION ELECTRONICS
BRISBANE, Australia
DOUGLAS ELECTRONICS

EUROPEAN TI DISTRIBUTORS

BRUSSELS IV, Belgium
S.A. AVI-ELEC N.V.

COPENHAGEN V, Denmark
TEXAS INSTRUMENTS A/S

HELSINKI, Finland
OY CHESTER AB

HAMBURG, West Germany
FIRMA ALFRED NEYE, ENATECHNIK

STUTTGART, WEST GERMANY
TI SUPPLY CO.

OSLO, Norway
MORGENSTIERNE & CO.

STOCKHOLM, Sweden
AB GOSTA BACKSTROM

ZURICH 32, Switzerland
FABRIMEX AG ZURICH

PARIS, FRANCE
TI SUPPLY CO.

MILANO, ITALY
TI SUPPLY CO.

MANCHESTER, ENGLAND
TI SUPPLY CO.

TYPES TIS37 AND TIS38 P-N-P EPITAXIAL PLANAR SILICON TRANSISTORS



TYPES TIS37 AND TIS38
 BULLETIN NO. DL-S 688935, APRIL 1966
 REVISED MAY 1968

SILECT† TRANSISTORS RECOMMENDED AS DESIGN REPLACEMENTS FOR GERMANIUM DRIFT TRANSISTORS IN:

- AM Automobile Radio RF and IF Converter Applications
- Portable AM Radios

mechanical data

These transistors are encapsulated in a plastic compound specifically designed for this purpose, using a highly mechanized process‡ developed by Texas Instruments. The case will withstand soldering temperatures without deformation. These devices exhibit stable characteristics under high-humidity conditions and are capable of meeting MIL-STD-202C method 106B. The transistors are insensitive to light.

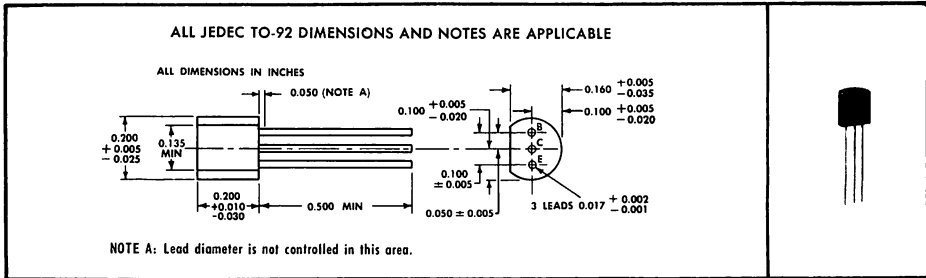

absolute maximum ratings at 25°C free-air temperature (unless otherwise noted)

	TIS37	TIS38
Collector-Base Voltage	-35 V	-35 V
Collector-Emitter Voltage (See Note 1)	-32 V	-32 V
Emitter-Base Voltage	-6 V	-4 V
Continuous Collector Current	←-50 mA→	
Continuous Device Dissipation at (or below) 25°C Free-Air Temperature (See Note 2)	←360 mW→	
Storage Temperature Range	-65°C to 150°C	
Lead Temperature 1/16 Inch from Case for 10 Seconds	←260°C→	

NOTES: 1. This value applies when the base-emitter diode is open-circuited.
 2. Derate linearly to 150°C free-air temperature at the rate of 2.88 mW/deg.

†Trademark of Texas Instruments
 ‡Patent Pending

TYPES TIS37 AND TIS38

P-N-P EPITAXIAL PLANAR SILICON TRANSISTORS

electrical characteristics at 25°C free-air temperature

PARAMETER	TEST CONDITIONS	TIS37			TIS38			UNIT
		MIN	TYP	MAX	MIN	TYP	MAX	
$V_{(BR)CBO}$ Collector-Base Breakdown Voltage	$I_C = -100 \mu A, I_E = 0$	-35			-35			V
$V_{(BR)CEO}$ Collector-Emitter Breakdown Voltage	$I_C = -1 \text{ mA}, I_B = 0$, See Note 3	-32			-32			V
$V_{(BR)EBO}$ Emitter-Base Breakdown Voltage	$I_E = -100 \mu A, I_C = 0$	-6			-4			V
I_{CBO} Collector Cutoff Current	$V_{CB} = -10 \text{ V}, I_E = 0$		-100			-100		nA
h_{FE} Static Forward Current Transfer Ratio	$V_{CE} = -9 \text{ V}, I_C = -1 \text{ mA}$	45			25			
$ h_{fo} $ Small-Signal Common-Emitter Forward Current Transfer Ratio	$V_{CE} = -9 \text{ V}, I_C = -1 \text{ mA}, f = 455 \text{ kHz}$	35	45		30	40		dB
	$V_{CE} = -9 \text{ V}, I_C = -1 \text{ mA}, f = 10 \text{ MHz}$	18	30		14	26		dB
$ Y_{fo} $ Small-Signal Common-Emitter Forward Transfer Admittance	$V_{CE} = -9 \text{ V}, I_C = -1 \text{ mA}, f = 455 \text{ kHz}$	32	35		32	35		mmho
f_T Transition Frequency	$V_{CE} = -9 \text{ V}, I_C = -1 \text{ mA}$, See Note 4	80	320		50	200		MHz
C_{cb} Collector-Base Capacitance	$V_{CB} = -9 \text{ V}, I_E = 0$, $f = 1 \text{ MHz}$, See Note 5	0.5	1.1	1.7	0.5	1.1	1.7	pF
$\tau_b \cdot C_c$ Collector-Base Time Constant	$V_{CB} = -9 \text{ V}, I_E = 1 \text{ mA}, f = 79.8 \text{ MHz}$	30	70		30	70		ps

operating characteristics at 25°C free-air temperature

PARAMETER	TEST CONDITIONS	TIS37			UNIT
		TYP			
NF Spot Noise Figure	$V_{CE} = -9 \text{ V}, I_C = -1 \text{ mA}, R_G = 75 \Omega, f = 1 \text{ MHz}$	2.5			dB
	$V_{CE} = -9 \text{ V}, I_C = -1 \text{ mA}, R_G = 1 \text{ k}\Omega, f = 1 \text{ MHz}$	1			dB

TYPICAL CHARACTERISTICS AT $T_A = 25^\circ\text{C}$

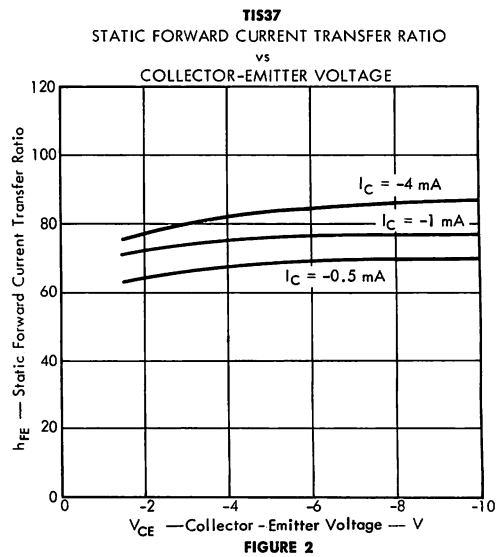
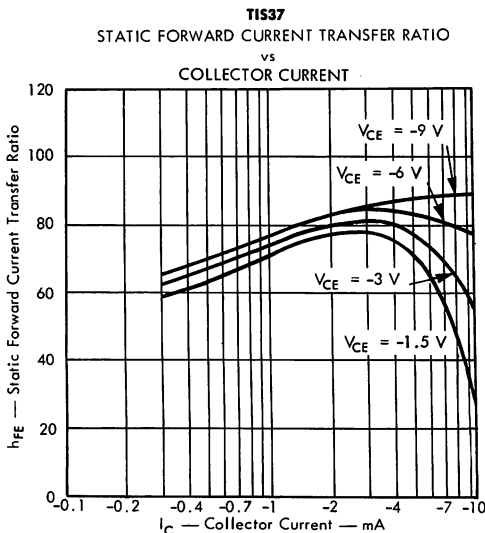

NOTES: 3. This parameter must be measured using pulse techniques. $t_p = 300 \mu s$, duty cycle $\leq 2\%$.

4. To obtain f_T , the $|h_{fo}|$ response with frequency is extrapolated at the rate of -6 dB per octave from $f = 10 \text{ MHz}$ to the frequency at which $|h_{fo}| = 1$.

5. C_{cb} is measured using three-terminal measurement techniques with the emitter guarded.

TYPES TIS37 AND TIS38 P-N-P EPITAXIAL PLANAR SILICON TRANSISTORS

TYPICAL CHARACTERISTICS AT $T_A = 25^\circ\text{C}$

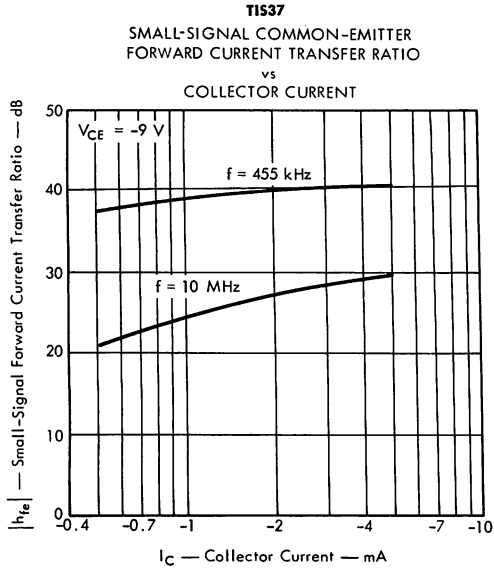

FIGURE 3

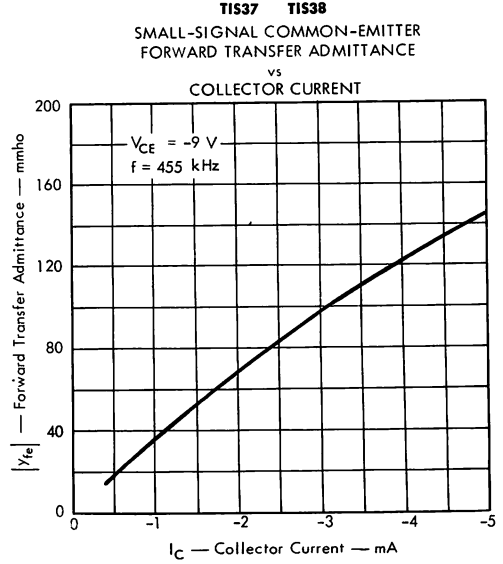

FIGURE 4

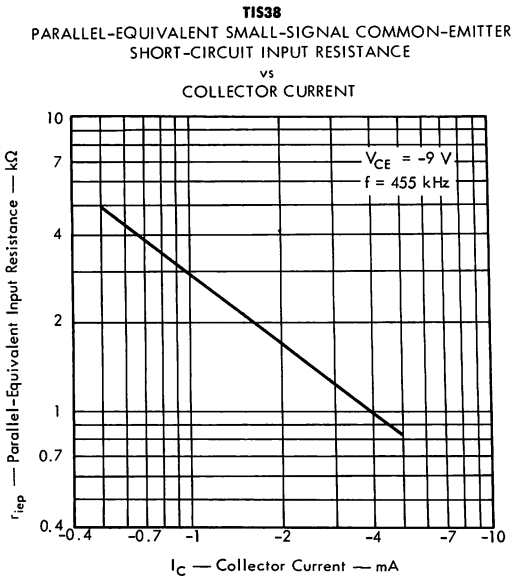

FIGURE 5

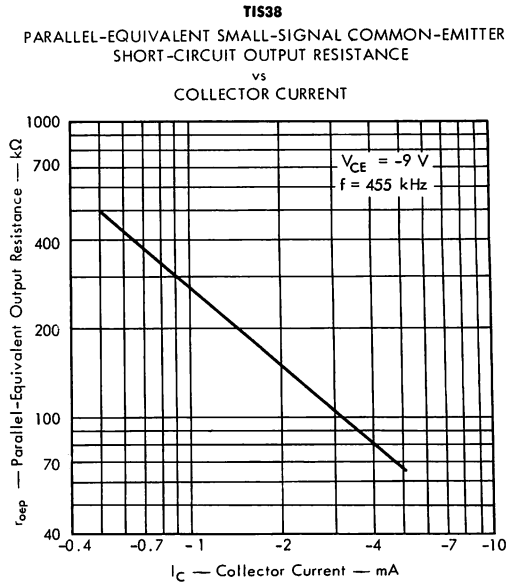
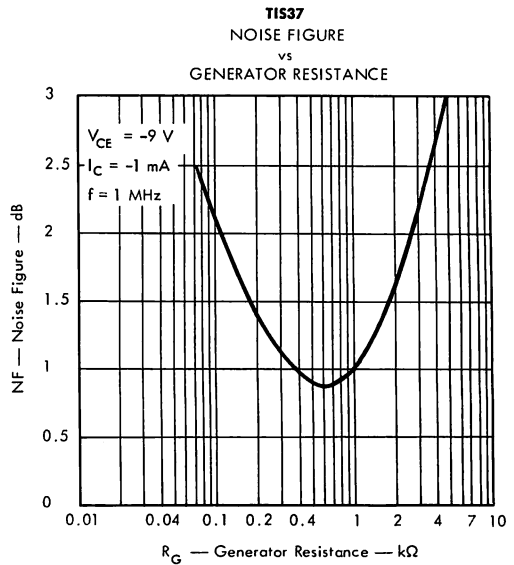
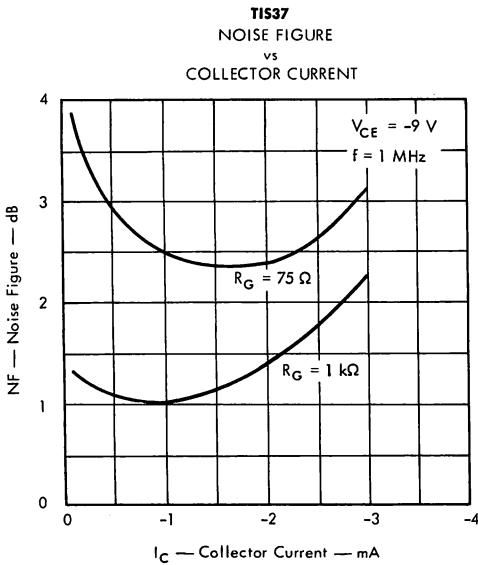
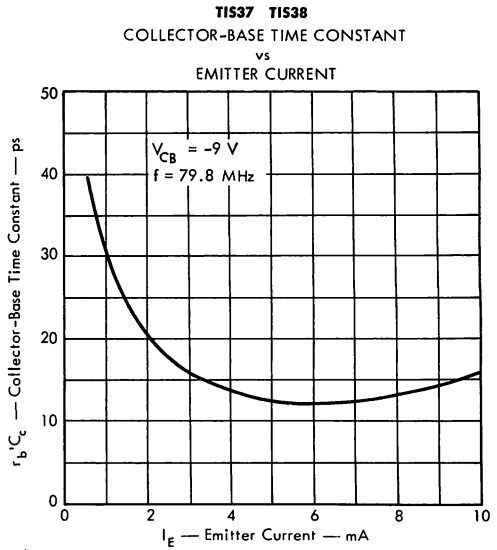
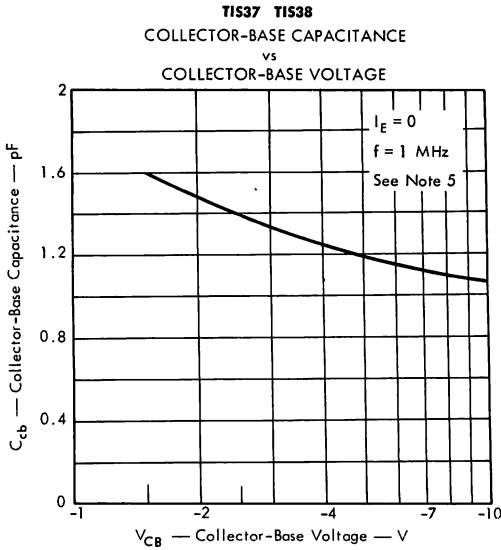

FIGURE 6

TYPES TIS37 AND TIS38 P-N-P EPITAXIAL PLANAR SILICON TRANSISTORS

TYPICAL CHARACTERISTICS AT $T_A = 25^\circ\text{C}$



NOTE 5: C_{cb} is measured using three-terminal measurement techniques with emitter guarded.

TYPES TIS37 AND TIS38 P-N-P EPITAXIAL PLANAR SILICON TRANSISTORS

TYPICAL APPLICATION DATA

AM CONVERTER WITH TWO-STAGE IF AMPLIFIER

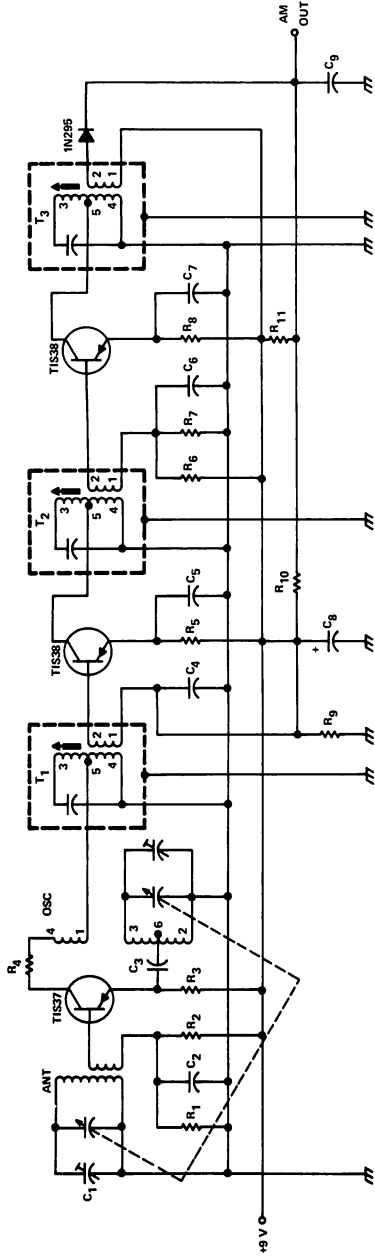

CA16835

CIRCUIT COMPONENT INFORMATION

- TYPICAL PERFORMANCE CHARACTERISTICS**
(Output Terminated with 5 k Ω)
- Sensitivity for 10 dB (S+N)/N 85 μ V/m
 - Audio Output at 10 dB (S+N)/N level 1.0 mV
 - Sensitivity for 20 dB (S+N)/N 250 μ V/m
 - Audio Output at 20 dB (S+N)/N level6.0 mV
 - RF Overload for 30% Modulation 170 mV/m
 - Modulation Overload at 80% Modulation 100 mV/m
 - 10 kHz Adjacent Channel Rejection 14.0 dB
 - +10 kHz Adjacent Channel Rejection 16.0 dB
 - AGC Figure of Merit 41 dB
 - Image Rejection at 600 kHz 43 dB
 - 6-dB Bandwidth at 600 kHz 7.2 kHz
- RESISTORS**
- R₁: 33 k Ω
 - R₂: 4.7 k Ω
 - R₃: 2.7 k Ω
 - R₄: 220 Ω
 - R₅: 680 Ω
 - R₆: 1.2 k Ω
 - R₇: 18 k Ω
 - R₈: 680 Ω
 - R₉: 68 k Ω
 - R₁₀: 6.8 k Ω
 - R₁₁: 1.5 k Ω
- CAPACITORS**
- C₁: TRW #V0916 (Type 42-2a) or equivalent
 - C₂: 0.05 μ F
 - C₃: 0.01 μ F
 - C₄: 0.05 μ F
 - C₅: 0.05 μ F
 - C₆: 0.05 μ F
 - C₇: 0.05 μ F
 - C₈: 5 μ F, 12 V electrolytic
 - C₉: 0.1 μ F
- TRANSFORMERS**
- Antenna: TRW #19029 or equivalent
 - Oscillator: TRW #18908-R1 or equivalent
 - T₁: TRW #21484 or equivalent
 - T₂: TRW #21485 or equivalent
 - T₃: TRW #21486 or equivalent

TI World-Wide Sales Offices

ALABAMA

Sahara Office Park Bldg., Suite 111
3313 Memorial Parkway, S.W.
Huntsville, Alabama 35801
205-881-4061

ARIZONA

2535 W. Camelback Rd., Suite 1D
Phoenix, Arizona 85017
602-279-5531

CALIFORNIA

1800 North Argyle Ave.
Hollywood, California 90028
213-466-7251

5005 West Century Blvd., Suite 208
Inglewood, California 90301
213-673-3943

230 California Ave., Suite 201
Palo Alto, California 94306
415-326-6770

1505 East 17th St., Suite 201
Santa Ana, California 92701
714-547-6506

4185 Adams Ave.
San Diego, California 92116
714-284-1181

COLORADO

2186 South Holly St., Suite 204
Denver, Colorado 80222
303-757-8548

CONNECTICUT

300 Amity Road
Woodbridge, Connecticut 06525
203-389-4521

FLORIDA

618 East South St., Suite 114
Orlando, Florida 32801
305-422-9894

ILLINOIS

Suite 205, Executive Towers
5901 N. Cicero Ave.
Chicago, Illinois 60646
312-286-1000

MASSACHUSETTS

60 Hickory Drive
Waltham, Mass. 02154
617-891-8450

MICHIGAN

Suite 706 West, Northland Towers Bldg.
15565 Northland Dr.
Southfield, Michigan 48075
313-357-1703

MINNESOTA

7615 Metro Blvd.
Suite 202, U.C.L.I. Bldg.
Edina, Minn. 55424
612-941-4384

NEW JERSEY

U.S. Highway #22
P.O. Box 366
Union, New Jersey 07083
201-687-7200

NEW YORK

P. O. Box 87, 2209 E. Main
Endicott, New York 13760
607-785-9987

4 Nevada Drive
New Hyde Park, N. Y. 11040
516-488-9894

131 Fulton Ave., Apt. J-2
Poughkeepsie, New York 12603
914-471-6095

6563 Ridings Rd.
Syracuse, New York 13206
315-463-9291

OHIO

22035 Chagrin Blvd.
Cleveland, Ohio 44122
216-751-2600

Suite 205, Paul Welch Bldg.
3300 South Dixie Dr.
Dayton, Ohio 45439
513-298-7513

PENNSYLVANIA

Benjamin Fox Pavilion
Suite 424, Foxcroft Square
Jenkintown, Pa. 19046
215-885-3454

TEXAS

MS80 — P.O. Box 5012
Dallas, Texas 75222
214-238-4861

3609 Buffalo Speedway
Houston, Texas 77006
713-526-3268

WASHINGTON

5801 Sixth Ave. S.
Seattle, Washington 98108
206-762-4240

WASHINGTON, D.C.

1875 Connecticut Ave., N.W., Suite 913
Washington, D.C. 20009
202-234-9320

CANADA

Geophysical Service Incorporated
280 Centre Str. East
Richmond Hills
Ontario, Canada
925-1035

663 Orly Avenue
Dorval
Quebec, Canada
631-6010

EUROPE

Texas Instruments Limited
Manton Lane
Bedford, England

Texas Instruments France S. A.
Boite Postale 5
Villeneuve-Loubet (A.M.), France

11 rue de Madrid
Paris 8^e, France

Texas Instruments Holland N.V.
Semiconductor Division
Enschedeestraat 19
Hengelo (Ov), Holland

Texas Instruments Italia S.p.A.
Via Colautti 1
Milan, Italy

Texas Instruments Incorporated
118 Rue du Rhone
1204 Geneva, Switzerland

Texas Instruments Sweden A.B.
Timmermangatan 34, Box 17116
Stockholm 17, Sweden

Texas Instruments Deutschland GmbH
Hildesheimerstr. 19
3 Hannover, W. Germany

Texas Instruments Deutschland GmbH
Wolframstrasse 26
7 Stuttgart
West Germany

Texas Instruments Deutschland GmbH
Clemensstrasse 30
8 Munich 23
West Germany

Texas Instruments Deutschland GmbH
Kepserstrasse 33
805 Freising-Lerchenzeld
West Germany

Texas Instruments Deutschland GmbH
Koenigsbacherstrasse 22
6 Frankfurt, West Germany

MEXICO

Texas Instruments de Mexico S.A.
Poniente 116 #489
Col. Ind. Vallejo
Mexico 15, D.F.

ARGENTINA

Texas Instruments Argentina S.A.I.C.F.
(P. O. Box 2296 — Correo Central)
Ruta Panamericana Km. 13, 5
Don Torcuato
Buenos Aires, Argentina

BRAZIL

Texas Instrumentos Electronicos
do Brazil Ltda.
Rua Cesario Alvim 770
Caixa Postal 30.103
Sao Paulo 6, Brazil

AUSTRALIA

Texas Instruments Australia Ltd.
Box 63, Oldham Road
Elizabeth, South Australia

Texas Instruments Australia Ltd.
Room 5, Rural Bank Bldg.
Burwood, N.S.W., Australia

JAPAN

Texas Instruments Asia Limited
404 T.B.R. Building
No. 59, 2-chome, Nagata-cho
Chiyoda-du, Tokyo, Japan

TYPES 2N2604, 2N2605 P-N-P EPITAXIAL PLANAR SILICON TRANSISTORS



FOR EXTREMELY LOW-LEVEL, LOW-NOISE, HIGH-GAIN, SMALL-SIGNAL AMPLIFIER APPLICATIONS

- Recommended for Complementary Use With TI 2N929, 2N930, and 2N2586 N-P-N Transistors
- Guaranteed h_{FE} at $10\mu a$, $T_A = -55^\circ C$ and $25^\circ C$
- Guaranteed Low-Noise Characteristics
- Usable at Collector Currents as Low as $1\mu a$

***mechanical data**

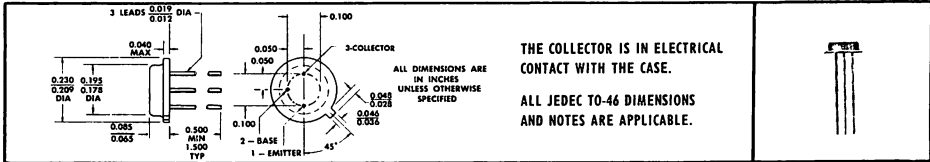

TYPES 2N2604, 2N2605
BULLETIN NO. DL-5 644027, FEBRUARY 1964
REVISED SEPTEMBER 1965

***absolute maximum ratings at 25°C free-air temperature (unless otherwise noted)**

Collector-Base Voltage	60 v
Collector-Emitter Voltage (See Note 1)	45 v
Emitter-Base Voltage	6 v
Collector Current	30 ma
Total Device Dissipation at (or below) 25°C Free-Air Temperature (See Note 2)	400 mw
Storage Temperature Range	-65°C to +200°C

***electrical characteristics at 25°C free-air temperature (unless otherwise noted)**

PARAMETER	TEST CONDITIONS	2N2604		2N2605		UNIT
		MIN	MAX	MIN	MAX	
V_{CB0} Collector-Base Breakdown Voltage	$I_C = -10\mu a, I_E = 0$	-60		-60		v
V_{CEO} Collector-Emitter Breakdown Voltage	$I_C = -10\mu a, I_B = 0$, See Note 3	-45		-45		v
V_{EBO} Emitter-Base Breakdown Voltage	$I_E = -10\mu a, I_C = 0$	-6		-6		v
I_{CB0} Collector Cutoff Current	$V_{CB} = -45\text{ v}, I_E = 0$		-10		-10	na
I_{CES} Collector Cutoff Current	$V_{CE} = -45\text{ v}, V_{BE} = 0$		-10		-10	na
	$V_{CE} = -45\text{ v}, V_{BE} = 0, T_A = 170^\circ C$		-10		-10	μa
I_{EBO} Emitter Cutoff Current	$V_{EB} = -5\text{ v}, I_C = 0$		-2		-2	na
h_{FE} Static Forward Current Transfer Ratio	$V_{CE} = -5\text{ v}, I_C = -10\mu a$	40	120	100	300	
	$V_{CE} = -5\text{ v}, I_C = -10\mu a, T_A = -55^\circ C$	10		20		
	$V_{CE} = -5\text{ v}, I_C = -500\mu a$	60		150		
	$V_{CE} = -5\text{ v}, I_C = -10\text{ ma}$		350		600	
V_{BE} Base-Emitter Voltage	$I_B = -0.5\text{ ma}, I_C = -10\text{ ma}$	-0.7	-0.9	-0.7	-0.9	v
$V_{CE(sat)}$ Collector-Emitter Saturation Voltage	$I_B = -0.5\text{ ma}, I_C = -10\text{ ma}$		-0.5		-0.5	v
h_{ib} Small-Signal Common-Base Input Impedance	$V_{CB} = -5\text{ v}, I_E = 1\text{ ma}, f = 1\text{ kc}$	25	35	25	35	ohm
h_{rb} Small-Signal Common-Base Reverse Voltage Transfer Ratio	$V_{CB} = -5\text{ v}, I_E = 1\text{ ma}, f = 1\text{ kc}$		10 x 10 ⁻⁴		10 x 10 ⁻⁴	
h_{ob} Small-Signal Common-Base Output Admittance	$V_{CB} = -5\text{ v}, I_E = 1\text{ ma}, f = 1\text{ kc}$		1.0		1.0	μmho
h_{fo} Small-Signal Common-Emitter Forward Current Transfer Ratio	$V_{CB} = -5\text{ v}, I_E = 1\text{ ma}, f = 1\text{ kc}$	60	350	150	600	
$ h_{fo} $ Small-Signal Common-Emitter Forward Current Transfer Ratio	$V_{CE} = -5\text{ v}, I_C = -500\mu a, f = 30\text{ Mc}$	1.0		1.0		
C_{ob} Common-Base Open-Circuit Output Capacitance	$V_{CB} = -5\text{ v}, I_E = 0, f = 1\text{ Mc}$		6		6	pf
$Re(h_{ie})$ Real Part of Small-Signal Common-Emitter Input Impedance	$V_{CE} = -5\text{ v}, I_C = -1\text{ ma}, f = 100\text{ Mc}$		200		200	ohm

NOTES: 1. This value applies between 0 and 10 ma collector current when the base-emitter diode is open-circuited.
 2. Degrade linearly to 200°C free-air temperature at the rate of 2.28 mw/°C.
 3. This parameter must be measured using pulse techniques. PW = 300 μsec , Duty Cycle \approx 2%.

*Indicates JEDEC registered data.

TYPES 2N2604, 2N2605

P-N-P EPITAXIAL PLANAR SILICON TRANSISTORS

*operating characteristics at 25°C free-air temperature

PARAMETER	TEST CONDITIONS	2N2604	2N2605	UNIT
		MAX	MAX	
NF Average Noise Figure	$V_{CE} = -5 \text{ v}$, $I_C = -10 \mu\text{a}$, $R_G = 10 \text{ k}\Omega$ Noise Bandwidth = 15.7 kc, (See Note 4)	4.0	3.0	db

NOTE 4. Average Noise Figure is measured in an amplifier with low-frequency-response down 3 db at 10 cps.

PARAMETER MEASUREMENT INFORMATION

A PROCEDURE FOR MEASURING AVERAGE NOISE FIGURE OF 2N2604 AND 2N2605

1. Connect audio oscillator to true RMS vacuum-tube voltmeter and adjust V_s for 0.81 mv.
2. Connect equipment as shown in block diagram, Figure 1.
3. Adjust d-c biases.
4. Adjust potentiometer for full scale deflection (10 db) on the voltmeter using the highest suitable range. The output is monitored on the oscilloscope to insure that clipping does not occur and that there is no extraneous pickup (e.g. 60 cps).
5. Remove V_s .
6. For a noiseless transistor the output would drop 20 db when the signal is removed from the input. Anything less than a 20 db drop is the noise figure of the transistor (e.g. — for a 17 db drop, NF = 3 db).

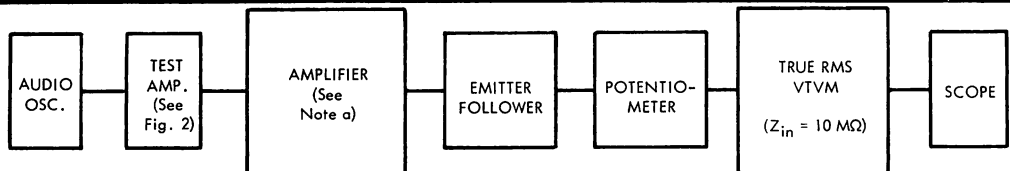

FIGURE 1 — BLOCK DIAGRAM

Note a: The amplifier has the following specifications: A_v , 100 maximum; Frequency Response, down 3 db at 10 cps and 10 kc with a high-frequency roll-off of 6 db/octave; Equivalent Input Noise, 1.5 μv RMS maximum for 10 kc bandwidth and 4 μv RMS maximum for 100 kc bandwidth between 10 cps and 1 mc; Z_{in} , 8 M Ω in parallel with 30 pf; Z_{out} , 600 Ω in series with 8 μf .

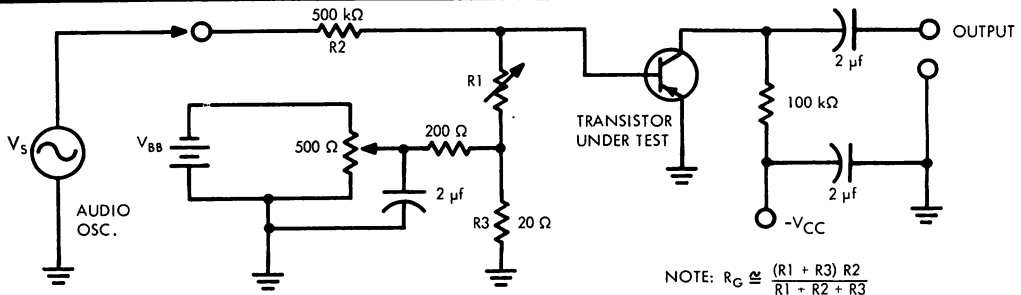

FIGURE 2 — TEST AMPLIFIER

*Indicates JEDEC registered data.

TYPES 2N2894, 2N3012 P-N-P EPITAXIAL PLANAR SILICON TRANSISTORS



TYPES 2N2894 AND 2N3012
BULLETIN NO. DL-5 645051, AUGUST 1964

DESIGNED FOR HIGH-SPEED SWITCHING APPLICATIONS

- Guaranteed $V_{CE(sat)}$ — 0.5 v Max at 100 ma
- High f_T — 400 Mc Min
- Recommended for Complementary Use With 2N2368 and 2N3011

*mechanical data

THE COLLECTOR IS IN ELECTRICAL CONTACT WITH THE CASE.

ALL JEDEC TO-18 DIMENSIONS AND NOTES ARE APPLICABLE.

*absolute maximum ratings at 25°C free-air temperature (unless otherwise noted)

Collector-Base Voltage	-12 v
Collector-Emitter Voltage (See Note 1)	-12 v
Emitter-Base Voltage	-4 v
Collector Current	-200 ma
Continuous Device Dissipation at (or below) 25°C Free-Air Temperature (See Note 2)	0.36 w
Continuous Device Dissipation at (or below) 25°C Case Temperature (See Note 3)	1.2 w
Operating Collector Junction Temperature	200°C
Storage Temperature Range	-65°C to +200°C
Lead Temperature 1/8 Inch from Case For 60 Seconds	300°C

*electrical characteristics at 25°C free-air temperature (unless otherwise noted)

PARAMETER	TEST CONDITIONS	2N2894		2N3012		UNIT
		MIN	MAX	MIN	MAX	
BV_{CBO} Collector-Base Breakdown Voltage	$I_C = -10 \mu a, I_E = 0$	-12		-12		v
BV_{CEO} Collector-Emitter Breakdown Voltage	$I_C = -10 ma, I_B = 0, \text{ See Note 4}$	-12		-12		v
BV_{CES} Collector-Emitter Breakdown Voltage	$I_C = -10 \mu a, V_{BE} = 0$	-12		-12		v
BV_{EBO} Emitter-Base Breakdown Voltage	$I_E = -100 \mu a, I_C = 0$	-4		-4		v
I_{CBO} Collector Cutoff Current	$V_{CB} = -6 v, I_E = 0, T_A = 125^\circ C$		-10			μa
I_{CES} Collector Cutoff Current	$V_{CE} = -6 v, V_{BE} = 0$		-80		-80	na
	$V_{CE} = -6 v, V_{BE} = 0, T_A = 85^\circ C$				-5	μa
I_B Base Current	$V_{CE} = -6 v, V_{BE} = 0$		80		30	na
h_{FE} Static Forward Current Transfer Ratio	$V_{CE} = -0.3 v, I_C = -10 ma, \text{ See Note 4}$		30		25	
	$V_{CE} = -0.5 v, I_C = -30 ma, \text{ See Note 4}$		40 150		30 120	
	$V_{CE} = -1 v, I_C = -100 ma, \text{ See Note 4}$		25		20	
	$V_{CE} = -0.5 v, I_C = -30 ma, T_A = -55^\circ C, \text{ See Note 4}$		17			
$V_{CE(sat)}$ Collector-Emitter Saturation Voltage	$I_B = -1 ma, I_C = -10 ma, \text{ See Note 4}$		-0.15		-0.15	v
	$I_B = -3 ma, I_C = -30 ma, \text{ See Note 4}$		-0.20		-0.20	v
	$I_B = -10 ma, I_C = -100 ma, \text{ See Note 4}$		-0.50		-0.50	v
	$I_B = -3 ma, I_C = -30 ma, T_A = 85^\circ C, \text{ See Note 4}$				-0.40	v
V_{BE} Base-Emitter Voltage	$I_B = -1 ma, I_C = -10 ma, \text{ See Note 4}$	-0.78	-0.98	-0.78	-0.98	v
	$I_B = -3 ma, I_C = -30 ma, \text{ See Note 4}$	-0.85	-1.2	-0.85	-1.2	v
	$I_B = -10 ma, I_C = -100 ma, \text{ See Note 4}$		-1.7		-1.7	v

- NOTES: 1. This value applies between 10 μa and 10 ma collector current when the base-emitter diode is open-circuited.
 2. Derate linearly to 200°C free-air temperature at the rate of 2.06 mw/C°.
 3. Derate linearly to 200°C case temperature at the rate of 6.85 mw/C°.
 4. This parameter must be measured using pulse techniques. PW = 300 μsec , Duty Cycle = 1%.

*Indicates JEDEC registered data.



TYPES 2N2894, 2N3012

P-N-P EPITAXIAL PLANAR SILICON TRANSISTORS

*electrical characteristics at 25°C free-air temperature

PARAMETER	TEST CONDITIONS	2N2894		2N3012		UNIT
		MIN	MAX	MIN	MAX	
$ h_{fe} $	Small-Signal Common-Emitter Forward Current Transfer Ratio $V_{CE} = -10$ v, $I_C = -30$ ma, $f = 100$ Mc	4		4		
C_{obo}	Common-Base Open-Circuit Output Capacitance $V_{CB} = -5$ v, $I_E = 0$, $f = 140$ kc		6		6	pf
C_{ibo}	Common-Base Open-Circuit Input Capacitance $V_{EB} = -0.5$ v, $I_C = 0$, $f = 140$ kc		6		6	pf

*switching characteristics at 25°C free-air temperature

PARAMETER	TEST CONDITIONS†	2N2894	2N3012	UNIT
		MAX	MAX	
t_{on}	Turn-On Time $I_C = -30$ ma, $I_{B(1)} = -1.5$ ma, $V_{BE(off)} = 3$ v, $R_i = 62 \Omega$, See Figure 1	60	60	nsec
t_{off}	Turn-Off Time $I_C = -30$ ma, $I_{B(1)} = -1.5$ ma, $I_{B(2)} = 1.5$ ma, $R_i = 62 \Omega$, See Figure 1	90	75	nsec

†Voltage and current values shown are nominal; exact values vary slightly with transistor parameters.

*PARAMETER MEASUREMENT INFORMATION

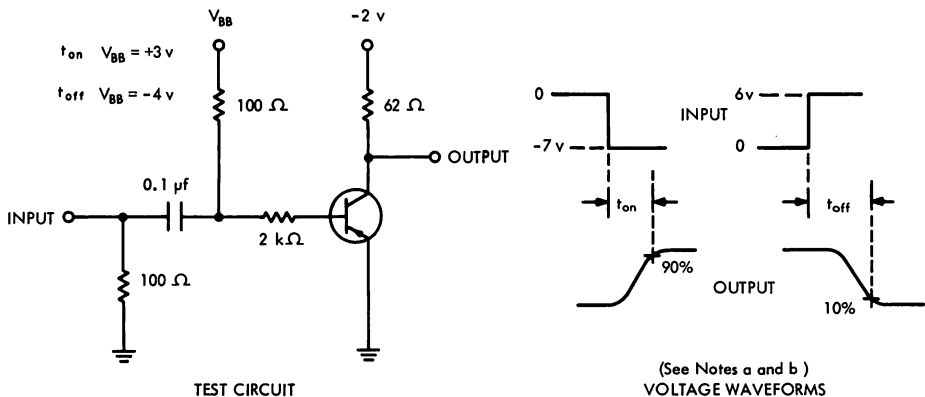

FIGURE 1 — TURN-ON AND TURN-OFF TIMES

NOTES: a. The input waveforms are supplied by a generator with the following characteristics: $Z_{out} = 50 \Omega$, $t_r \leq 1$ nsec, $PW > 200$ nsec.

b. Waveforms are monitored on an oscilloscope with the following characteristics: $t_r \leq 1$ nsec, $R_{in} \geq 100$ k Ω .

*Indicates JEDEC registered data.

TYPES 2N2904, 2N2905, 2N2906, 2N2907 P-N-P EPITAXIAL PLANAR SILICON TRANSISTORS



DESIGNED FOR HIGH-SPEED, MEDIUM-POWER SWITCHING
AND GENERAL PURPOSE AMPLIFIER APPLICATIONS

- High Breakdown Voltage Combined With Very-Low Saturation Voltage
- DC Beta — Guaranteed From 100 μ a to 500 ma

***mechanical data**

Device types 2N2904 and 2N2905 are in JEDEC TO-5 packages.
Device types 2N2906 and 2N2907 are in JEDEC TO-18 packages.

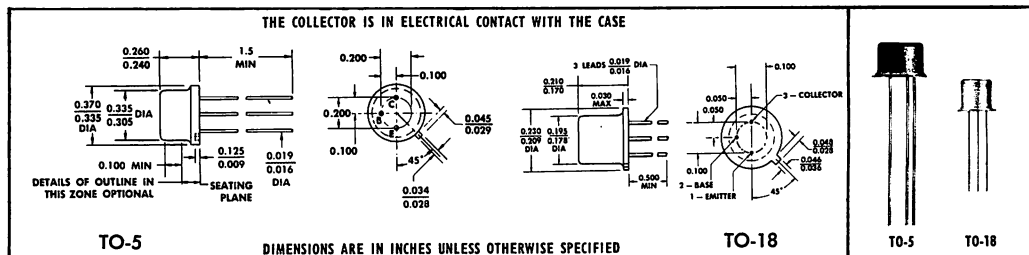

TYPES 2N2904, 2N2905, 2N2906, 2N2907
BULLETIN NO. DL-5 649045, MARCH 1964
REVISED SEPTEMBER 1965

***absolute maximum ratings at 25°C free-air temperature (unless otherwise noted)**

	2N2904 2N2905	2N2906 2N2907
Collector-Base Voltage	-60 v	-60 v
Collector-Emitter Voltage (See Note 1)	-40 v	-40 v
Emitter-Base Voltage	-5 v	-5 v
Collector Current	-0.6 a	-0.6 a
Total Device Dissipation at (or below) 25°C Free-Air Temperature (See Notes 2 and 3)	0.6 w	0.4 w
Total Device Dissipation at (or below) 25°C Case Temperature (See Notes 4 and 5)	3 w	1.8 w
Storage Temperature Range	-65°C to +200°C	

***electrical characteristics at 25°C free-air temperature (unless otherwise noted)**

PARAMETER	TEST CONDITIONS	2N2904 2N2906		2N2905 2N2907		UNIT
		MIN	MAX	MIN	MAX	
BV_{CBO} Collector-Base Breakdown Voltage	$I_C = -10 \mu a, I_E = 0$	-60		-60		v
BV_{CEO} Collector-Emitter Breakdown Voltage	$I_C = -10 ma, I_B = 0$, See Note 6	-40		-40		v
BV_{EBO} Emitter-Base Breakdown Voltage	$I_E = -10 \mu a, I_C = 0$	-5		-5		v
I_{CBO} Collector Cutoff Current	$V_{CB} = -50 v, I_E = 0$		-20		-20	na
	$V_{CB} = -50 v, I_E = 0, T_A = 150^\circ C$		-20		-20	μa
I_{CEX} Collector Cutoff Current	$V_{CE} = -30 v, V_{BE} = 0.5 v$		-50		-50	na
I_B Base Current	$V_{CE} = -30 v, V_{BE} = 0.5 v$		50		50	na
	$V_{CE} = -10 v, I_C = -100 \mu a$	20		35		
h_{FE} Static Forward Current Transfer Ratio	$V_{CE} = -10 v, I_C = -1 ma$	25		50		
	$V_{CE} = -10 v, I_C = -10 ma$	35		75		
	$V_{CE} = -10 v, I_C = -150 ma$, See Note 6	40	120	100	300	
	$V_{CE} = -10 v, I_C = -500 ma$, See Note 6	20		30		
V_{BE} Base-Emitter Voltage	$I_B = -15 ma, I_C = -150 ma$, See Note 6		-1.3		-1.3	v
	$I_B = -50 ma, I_C = -500 ma$, See Note 6		-2.6		-2.6	v
$V_{CE(sat)}$ Collector-Emitter Saturation Voltage	$I_B = -15 ma, I_C = -150 ma$, See Note 6		-0.4		-0.4	v
	$I_B = -50 ma, I_C = -500 ma$, See Note 6		-1.6		-1.6	v

NOTES: 1. This value applies between 0 and 100 ma collector current when the base-emitter diode is open-circuited.
2. Derate 2N2904 and 2N2905 linearly to 200°C free-air temperature at the rate of 3.43 mw/°C.
3. Derate 2N2906 and 2N2907 linearly to 200°C free-air temperature at the rate of 2.28 mw/°C.
4. Derate 2N2904 and 2N2905 linearly to 200°C case temperature at the rate of 17.3 mw/°C.
5. Derate 2N2906 and 2N2907 linearly to 200°C case temperature at the rate of 10.3 mw/°C.
6. These parameters must be measured using pulse techniques. PW \leq 300 μ sec, Duty Cycle \leq 2%.

*Indicates JEDEC registered data.



TEXAS INSTRUMENTS
INCORPORATED
POST OFFICE BOX 5012 • DALLAS, TEXAS 75222

TYPES 2N2904, 2N2905, 2N2906, 2N2907 P-N-P EPITAXIAL PLANAR SILICON TRANSISTORS

*electrical characteristics at 25°C free-air temperature

PARAMETER	TEST CONDITIONS	ALL		UNIT
		MIN	MAX	
C_{ob} Common-Base Open Circuit Output Capacitance	$V_{CB} = -10$ v, $I_E = 0$, $f = 100$ kc	8.0		pf
C_{ib} Common-Base Open Circuit Input Capacitance	$V_{EB} = -2$ v, $I_C = 0$, $f = 100$ kc	30		pf
$ h_{fe} $ Small-Signal Common-Emitter Forward Current Transfer Ratio	$V_{CE} = -20$ v, $I_C = -50$ ma, $f = 100$ Mc	2.0		

*switching characteristics at 25°C free-air temperature

PARAMETER	TEST CONDITIONS†	MAX	UNIT
t_d Delay Time	$I_C = -150$ ma, $I_{B(1)} = -15$ ma, $V_{BE(off)} = 0$, $R_L = 200 \Omega$, See Figure 1	10	nsec
t_r Rise Time		40	nsec
t_{on} Turn-On Time		45	nsec
t_s Storage Time	$I_C = -150$ ma, $I_{B(1)} = -13$ ma, $I_{B(2)} = 17$ ma, $R_L = 37 \Omega$, See Figure 2	80	nsec
t_f Fall Time		30	nsec
t_{off} Turn-Off Time		100	nsec

†Voltage and current values shown are nominal; exact values vary slightly with transistor parameters.

*PARAMETER MEASUREMENT INFORMATION

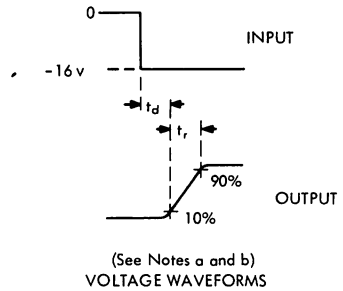
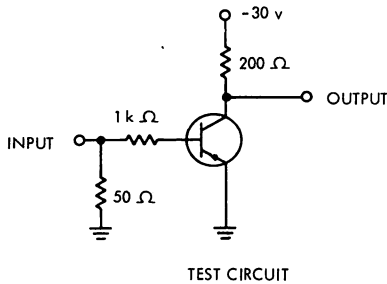

FIGURE 1

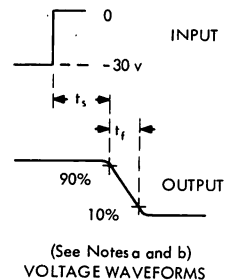
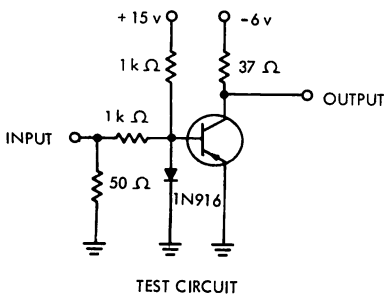

FIGURE 2

NOTES: a. The input waveforms are supplied by a generator with the following characteristics: $Z_{out} = 50 \Omega$, $t_r \leq 2$ nsec, $t_f \leq 2$ nsec, $PW = 200$ nsec, $PRR = 150$ pps.
b. Waveforms are monitored on an oscilloscope with the following characteristics: $t_r \leq 5$ nsec, $R_{in} = 10$ M Ω .

*Indicates JEDEC registered data.

TYPES 2N2944, 2N2945, 2N2946, 2N2944A, 2N2945A, 2N2946A P-N-P EPITAXIAL-BASE PLANAR SILICON TRANSISTORS



TYPES 2N2944 THRU 2N2946, 2N2944A THRU 2N2946A
BULLETIN NO. DL-5 679561, MARCH 1967
REPLACES BULLETIN NO. DL-5 645138, AUGUST 1964

FOR LOW-LEVEL, HIGH-SPEED CHOPPER APPLICATIONS IN INVERTED CONNECTION

- Low Guaranteed Offset Voltage
- High Emitter-Base Breakdown Voltage
- Greatly Improved $h_{FE(inv)} \dots 50$ Min at $I_B = 200 \mu A$ (2N2944A)
- Extremely Low $r_{ec(on)} \dots 4 \Omega$ Max (2N2944A)
- Recommended For Complementary Use with 2N2432A

*mechanical data

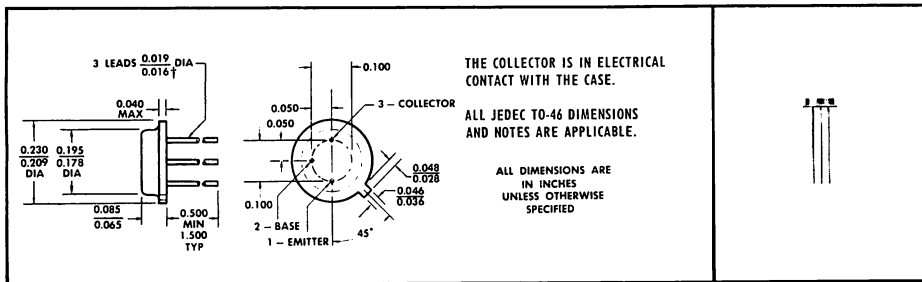

†TI guaranteed minimum. The JEDEC registered minimum lead diameter for the TO-46 is 0.012.

*absolute maximum ratings at 25°C free-air temperature (unless otherwise noted)

	2N2944 2N2944A	2N2945 2N2945A	2N2946 2N2946A
Collector-Base Voltage, V_{CB}	-15 V	-25 V	-40 V
Emitter-Collector Voltage, V_{ECO} (See Note 1)	-10 V	-20 V	-35 V
Emitter-Base Voltage, V_{EB}	-15 V	-25 V	-40 V
Continuous Collector Current	← -100 mA →		
Continuous Device Dissipation at (or below) 25°C Free-Air Temperature (See Note 2)	← 0.4 W →		
Storage Temperature Range	← -65°C to 200°C →		
Lead Temperature 1/8 Inch from Case for 10 Seconds	← 240°C →		

NOTES: 1. This value applies when the collector-base diode is open-circuited.
2. Derate linearly to 200°C free-air temperature at the rate of 2.3 mW/deg.

*Indicates JEDEC registered data

TYPES 2N2944 THRU 2N2946, 2N2944A THRU 2N2946A

P-N-P EPITAXIAL-BASE PLANAR SILICON TRANSISTORS

electrical characteristics at 25°C free-air temperature (unless otherwise noted)

PARAMETER	TEST CONDITIONS	2N2944	2N2945	2N2946	UNIT	
		MIN	MAX	MIN		MAX
I_{CBO} Collector Cutoff Current	$V_{CB} = \text{Rated } V_{CB}, I_E = 0$		-0.1*	-0.2*	-0.5*	nA
	$V_{CB} = \text{Rated } V_{CB}, I_E = 0, T_A = 100^\circ\text{C}$		-10	-20	-25	nA
I_{EBO} Emitter Cutoff Current	$V_{EB} = \text{Rated } V_{EB}, I_C = 0$		-0.1*	-0.2*	-0.5*	nA
	$V_{EB} = \text{Rated } V_{EB}, I_C = 0, T_A = 100^\circ\text{C}$		-10	-15	-20	nA
h_{FE} Static Forward Current Transfer Ratio	$V_{CE} = -0.5 \text{ V}, I_C = -1 \text{ mA}$	80*		40*	30*	
$h_{FE(inv)}$ Static Forward Current Transfer Ratio (Inverted Connection)	$V_{EC} = -0.5 \text{ V}, I_B = -200 \mu\text{A}$	6		4	3	
$V_{EC(ofs)}$ Emitter-Collector Offset Voltage	$I_B = -200 \mu\text{A}, I_E = 0$ $I_B = -1 \text{ mA}, I_E = 0$ $I_B = -2 \text{ mA}, I_E = 0$	See Figure 1	-0.3	-0.5	-0.8	mV
		Figure 1	-0.6*	-1*	-2*	mV
		1	-1	-1.6	-2.5	mV
$r_{ec(on)}$ Small-Signal Emitter-Collector On-State Resistance	$I_B = -1 \text{ mA}, I_E = 0, I_o = 100 \mu\text{A}, f = 1 \text{ kHz},$ See Figure 2		20*	35*	45*	Ω
$ h_{fe} $ Small-Signal Common-Emitter Forward Current Transfer Ratio	$V_{CE} = -6 \text{ V}, I_C = -1 \text{ mA}, f = 1 \text{ MHz}$	10*		5*	3*	
C_{obo} Common-Base Open-Circuit Output Capacitance	$V_{CB} = -6 \text{ V}, I_E = 0, f = 500 \text{ kHz}$		10*	10*	10*	pF
C_{ibo} Common-Base Open-Circuit Input Capacitance	$V_{EB} = -6 \text{ V}, I_C = 0, f = 500 \text{ kHz}$		6*	6*	6*	pF

electrical characteristics at 25°C free-air temperature (unless otherwise noted)

PARAMETER	TEST CONDITIONS	2N2944A	2N2945A	2N2946A	UNIT	
		MIN	MAX	MIN		MAX
I_{CBO} Collector Cutoff Current	$V_{CB} = \text{Rated } V_{CB}, I_E = 0$		-0.1*	-0.2*	-0.5*	nA
	$V_{CB} = \text{Rated } V_{CB}, I_E = 0, T_A = 100^\circ\text{C}$		-10*	-20*	-25*	nA
I_{EBO} Emitter Cutoff Current	$V_{EB} = \text{Rated } V_{EB}, I_C = 0$		-0.1*	-0.2*	-0.5*	nA
	$V_{EB} = \text{Rated } V_{EB}, I_C = 0, T_A = 100^\circ\text{C}$		-10*	-15*	-20*	nA
h_{FE} Static Forward Current Transfer Ratio	$V_{CE} = -0.5 \text{ V}, I_C = -1 \text{ mA}$	100*		70*	50*	
$h_{FE(inv)}$ Static Forward Current Transfer Ratio (Inverted Connection)	$V_{EC} = -0.5 \text{ V}, I_B = -200 \mu\text{A}$	50*		30*	20*	
$V_{EC(ofs)}$ Emitter-Collector Offset Voltage	$I_B = -200 \mu\text{A}, I_E = 0$ $I_B = -1 \text{ mA}, I_E = 0$ $I_B = -2 \text{ mA}, I_E = 0$	See Figure 1	-0.3*	-0.5*	-0.8*	mV
		Figure 1	-0.6*	-1*	-2*	mV
		1	-1*	-1.6*	-2.5*	mV
$r_{ec(on)}$ Small-Signal Emitter-Collector On-State Resistance	$I_B = -1 \text{ mA}, I_E = 0, I_o = 100 \mu\text{A}, f = 1 \text{ kHz},$ See Figure 2		4*	6*	8*	Ω
$ h_{fe} $ Small-Signal Common-Emitter Forward Current Transfer Ratio	$V_{CE} = -6 \text{ V}, I_C = -1 \text{ mA}, f = 1 \text{ MHz}$	15*		10*	5*	
C_{obo} Common-Base Open-Circuit Output Capacitance	$V_{CB} = -6 \text{ V}, I_E = 0, f = 0.1 \text{ MHz to } 1 \text{ MHz}$		10*	10*	10*	pF
C_{ibo} Common-Base Open-Circuit Input Capacitance	$V_{EB} = -6 \text{ V}, I_C = 0, f = 0.1 \text{ MHz to } 1 \text{ MHz}$		6*	6*	6*	pF

PARAMETER MEASUREMENT INFORMATION

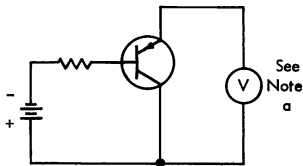

FIGURE 1

MEASUREMENT CIRCUIT FOR OFFSET VOLTAGE

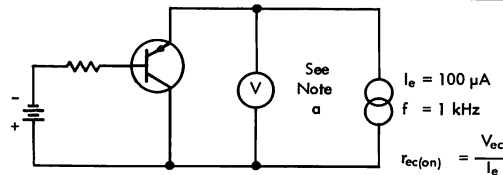

FIGURE 2

MEASUREMENT CIRCUIT FOR EMITTER-COLLECTOR ON-STATE RESISTANCE

NOTE a: The voltmeter must have high enough impedance that halving the value of the voltmeter impedance does not change the measured value.

*Indicates JEDEC registered data

TYPES 2N2944 THRU 2N2946, 2N2944A THRU 2N2946A

P-N-P EPITAXIAL-BASE PLANAR SILICON TRANSISTORS

TYPICAL CHARACTERISTICS

2N2944A

EMITTER-COLLECTOR VOLTAGE
vs
BASE CURRENT

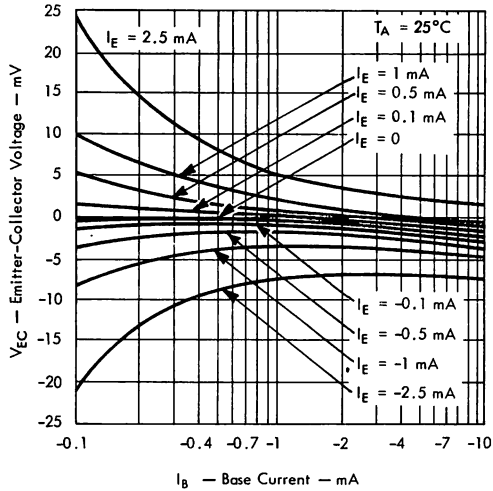

FIGURE 3

2N2945A

EMITTER-COLLECTOR VOLTAGE
vs
BASE CURRENT

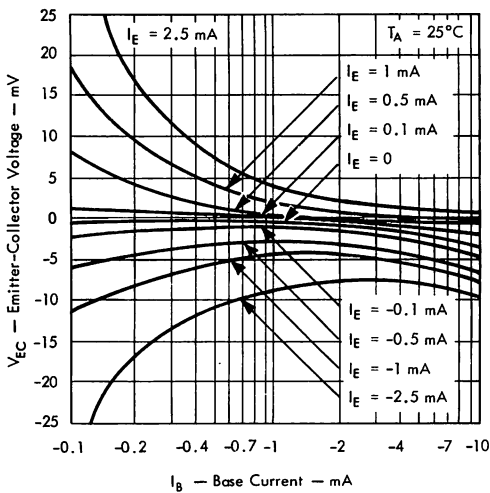

FIGURE 4

2N2946A

EMITTER-COLLECTOR VOLTAGE
vs
BASE CURRENT

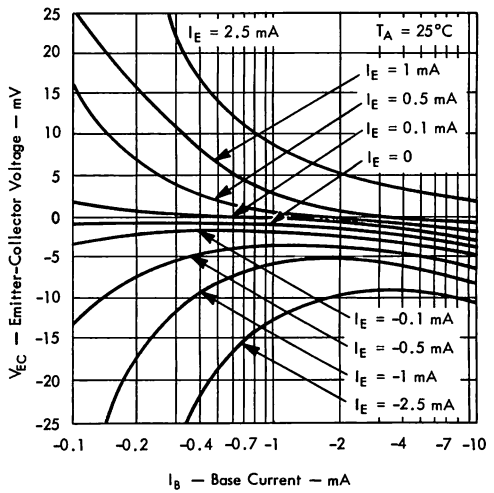

FIGURE 5

TYPES 2N2944 THRU 2N2946, 2N2944A THRU 2N2946A P-N-P EPITAXIAL-BASE PLANAR SILICON TRANSISTORS

TYPICAL CHARACTERISTICS

2N2944, 2N2944A
EMITTER-COLLECTOR OFFSET VOLTAGE
vs
BASE CURRENT

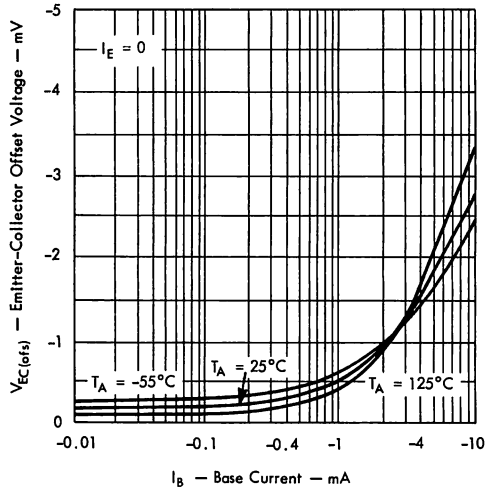

FIGURE 6

2N2945, 2N2945A
EMITTER-COLLECTOR OFFSET VOLTAGE
vs
BASE CURRENT

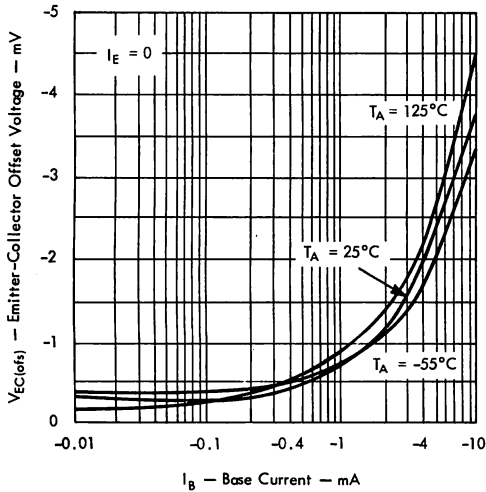

FIGURE 7

2N2946, 2N2946A
EMITTER-COLLECTOR OFFSET VOLTAGE
vs
BASE CURRENT

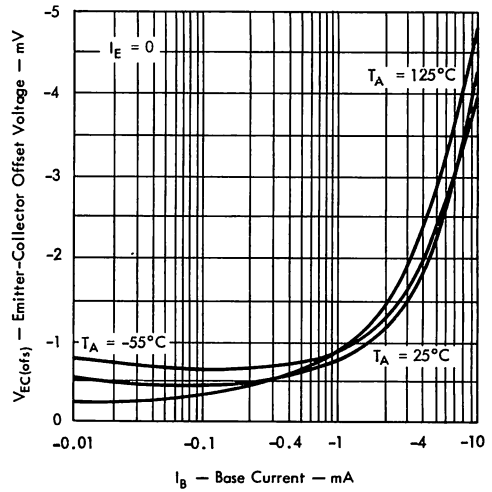

FIGURE 8

TYPES 2N2944 THRU 2N2946, 2N2944A THRU 2N2946A P-N-P EPITAXIAL-BASE PLANAR SILICON TRANSISTORS

TYPICAL CHARACTERISTICS

2N2946, 2N2946A
COLLECTOR CUTOFF CURRENT
vs
FREE-AIR TEMPERATURE

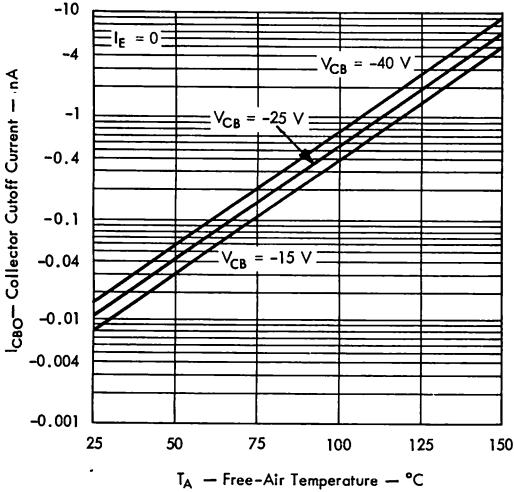

FIGURE 9

2N2946, 2N2946A
EMITTER CUTOFF CURRENT
vs
FREE-AIR TEMPERATURE

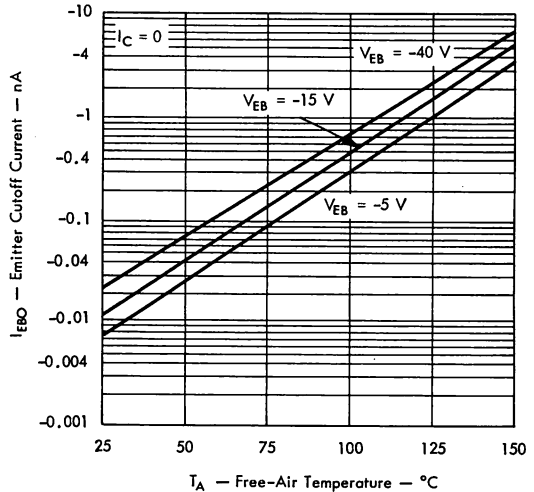

FIGURE 10

2N2944A
STATIC FORWARD CURRENT TRANSFER RATIO
vs
COLLECTOR CURRENT

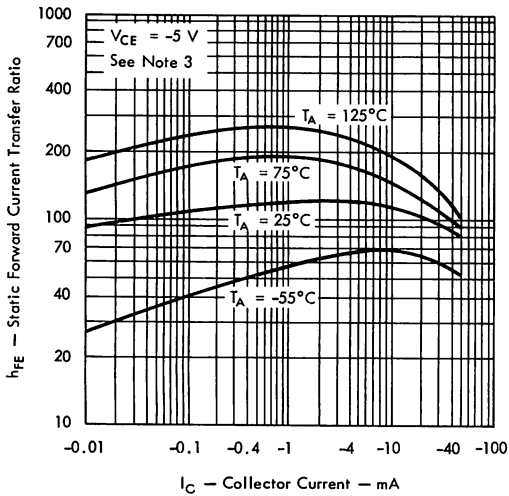

FIGURE 11

2N2944A
STATIC FORWARD CURRENT TRANSFER RATIO
vs
COLLECTOR CURRENT

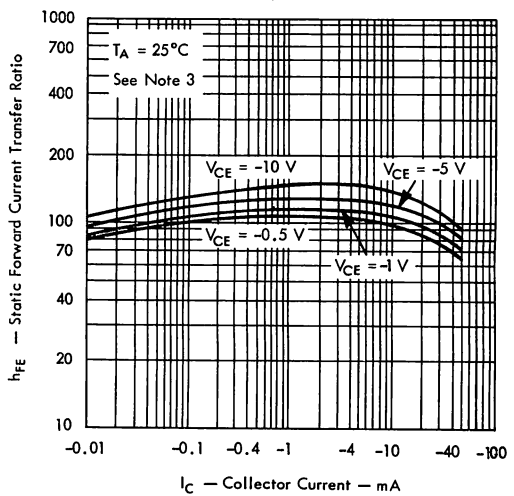
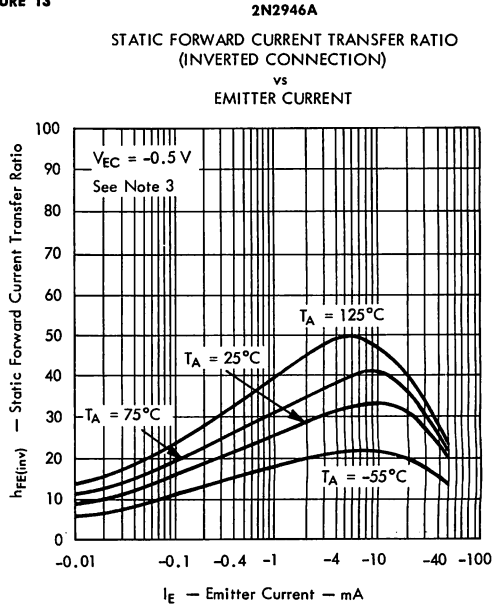
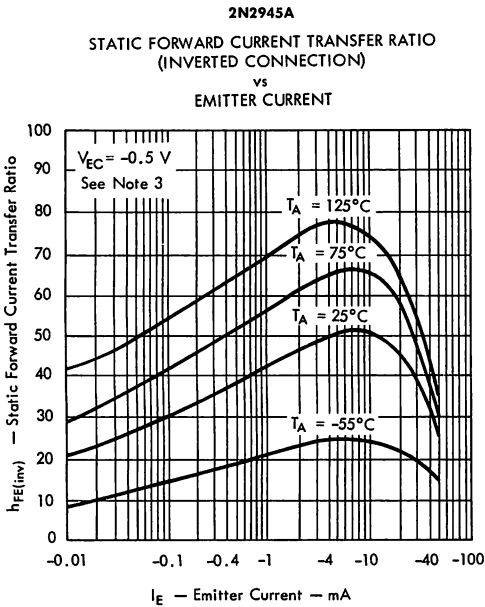
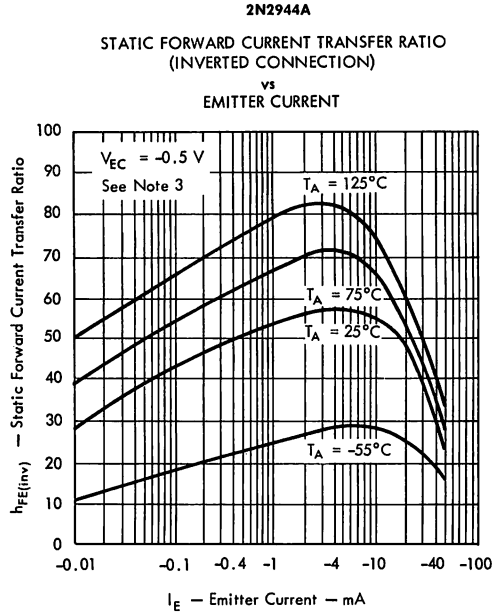

FIGURE 12

NOTE 3: These parameters must be measured using pulse techniques. $t_p = 300 \mu s$, duty cycle $\leq 2\%$.

TYPES 2N2944 THRU 2N2946, 2N2944A THRU 2N2946A P-N-P EPITAXIAL-BASE PLANAR SILICON TRANSISTORS

TYPICAL CHARACTERISTICS



NOTE 3: These parameters must be measured using pulse techniques. $I_p = 300 \mu s$, duty cycle $\leq 2\%$.

TYPES 2N2944 THRU 2N2946, 2N2944A THRU 2N2946A P-N-P EPITAXIAL-BASE PLANAR SILICON TRANSISTORS

TYPICAL CHARACTERISTICS

ALL TYPES
BASE-EMITTER VOLTAGE
vs
COLLECTOR CURRENT

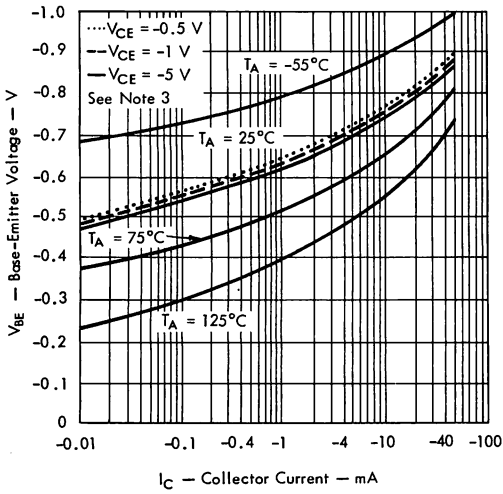

FIGURE 16

ALL TYPES
BASE-COLLECTOR VOLTAGE
vs
EMITTER CURRENT

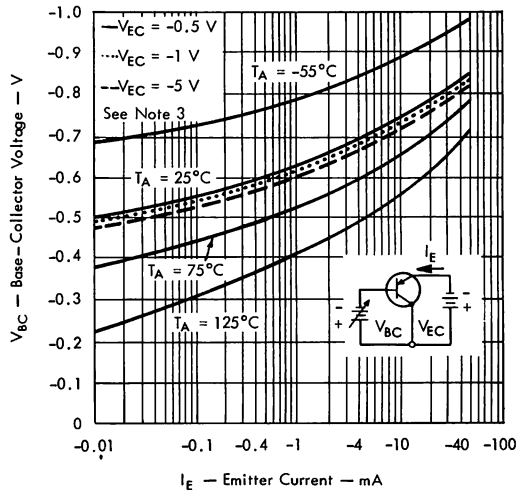

FIGURE 17

2N2944A
COLLECTOR-EMITTER SATURATION VOLTAGE
vs
COLLECTOR CURRENT

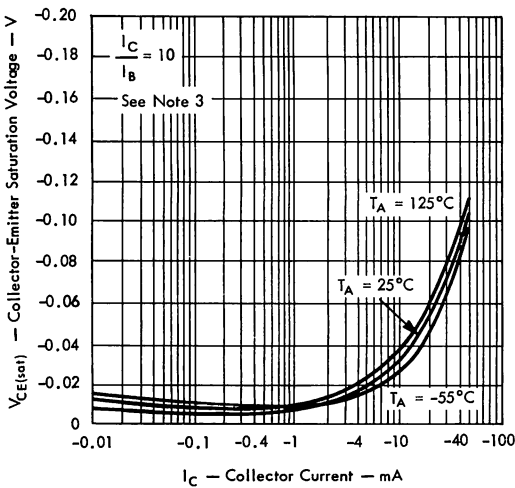

FIGURE 18

2N2944A
COLLECTOR-EMITTER SATURATION VOLTAGE
vs
COLLECTOR CURRENT

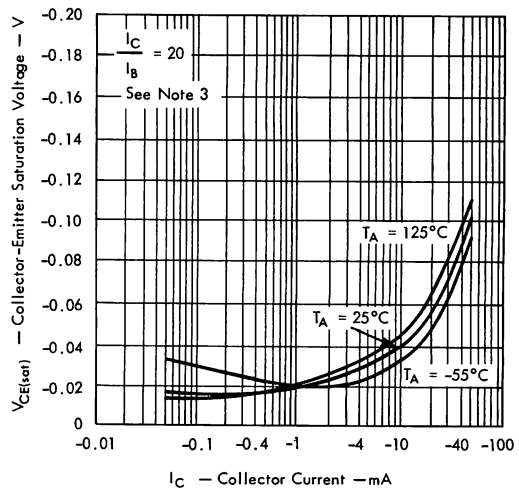

FIGURE 19

NOTE 3: These parameters must be measured using pulse techniques. $t_p \approx 300$ ms, duty cycle $\leq 2\%$.

TYPES 2N2944 THRU 2N2946, 2N2944A THRU 2N2946A P-N-P EPITAXIAL-BASE PLANAR SILICON TRANSISTORS

TYPICAL CHARACTERISTICS

2N2944A

SMALL-SIGNAL EMITTER-COLLECTOR ON-STATE RESISTANCE
vs
BASE CURRENT

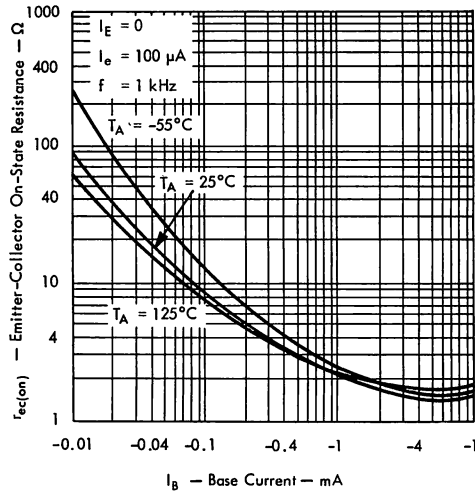

FIGURE 20

ALL TYPES

COMMON-BASE OPEN-CIRCUIT INPUT CAPACITANCE
vs
EMITTER-BASE VOLTAGE

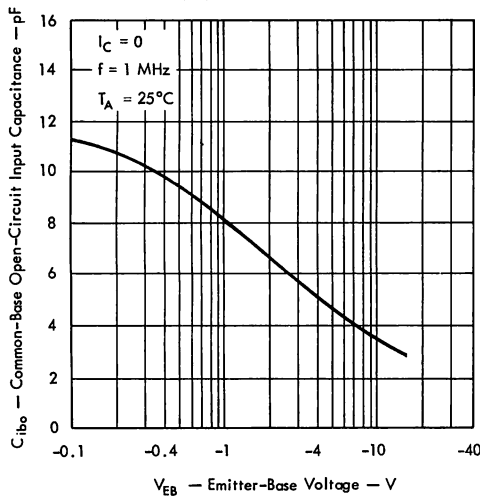

FIGURE 21

ALL TYPES

COMMON-BASE OPEN-CIRCUIT OUTPUT CAPACITANCE
vs
COLLECTOR-BASE VOLTAGE

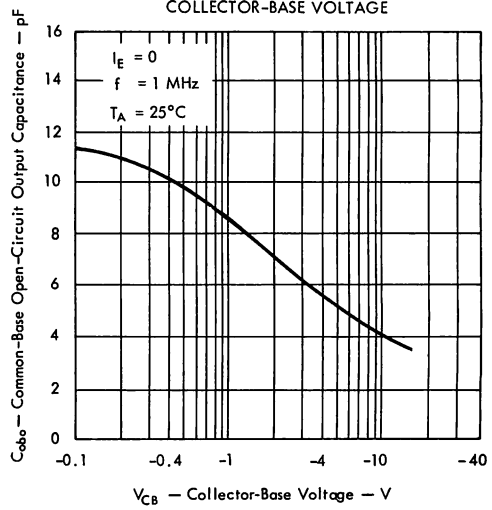

FIGURE 22

TYPES 2N3244, 2N3245, 2N3467, 2N3468 P-N-P EPITAXIAL PLANAR SILICON TRANSISTORS



TYPES 2N3244, 2N3245, 2N3467, 2N3468
 BULLETIN NO. DL-5 68 10576, MAY 1968
 REPLACES BULLETIN NO. DL-5 668358, FEBRUARY 1966

MADE WITH TRI-REL† REDUNDANT STABILIZATION

- Field-Relief Electrode‡
- Special Oxide Passivation
- Annular Guard Ring‡

DESIGNED FOR HIGH-SPEED CORE-DRIVER APPLICATIONS

- High Dissipation Capability... 10 Watts at 25°C Case Temperature
- High $V_{(BR)CEO}$... 50 V Min (2N3245, 2N3468)
- High Speed... 60 ns Max t_s at 500 mA (2N3467, 2N3468)
- High Collector Current Rating... 1 A

*mechanical data

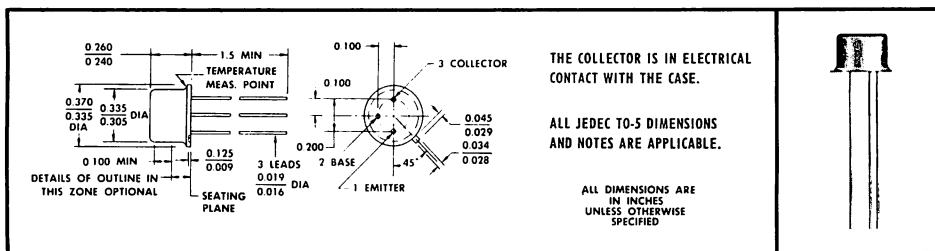

absolute maximum ratings at 25°C free-air temperature (unless otherwise noted)

	2N3244	2N3245	2N3467	2N3468	UNIT
Collector-Base Voltage	-40*	-50*	-40*	-50*	V
Collector-Emitter Voltage (See Note 1)	-40*	-50*	-40*	-50*	V
Emitter-Base Voltage	-5*	-5*	-5*	-5*	V
Continuous Collector Current	-1*	-1*	-1*	-1*	A
Continuous Device Dissipation at (or below) 25°C Free-Air Temperature (See Note 2)	1*	1*	1*	1*	W
Continuous Device Dissipation at (or below) 25°C Case Temperature (See Note 3)	10 [‡] 5*	10 [‡] 5*	10	10	W
Storage Temperature Range	-65 to 200*				°C
Lead Temperature $\frac{1}{16}$ Inch from Case for 10 Seconds			230*		°C
Lead Temperature $\frac{1}{16}$ Inch from Case for 60 Seconds	300*		300 [‡]		°C

- NOTES: 1. This value applies between 0 and 1 A collector current when the base-emitter diode is open-circuited.
 2. Derate linearly to 200°C free-air temperature at the rate of 5.71 mW/deg.
 3. Derate the 10-watt TI value linearly to 200°C case temperature at the rate of 57.1 mW/deg.
 Derate the 5-watt JEDEC value linearly to 200°C case temperature at the rate of 28.6 mW/deg.

† Trademark of Texas Instruments

‡ Patented by Texas Instruments

* Indicates JEDEC registered data

‡ This value is guaranteed by Texas Instruments in addition to the JEDEC registered value which is also shown.



TEXAS INSTRUMENTS
 INCORPORATED
 POST OFFICE BOX 5012 • DALLAS, TEXAS 75222

TYPES 2N3244, 2N3245, 2N3467, 2N3468

P-N-P EPITAXIAL PLANAR SILICON TRANSISTORS

*electrical characteristics at 25°C free-air temperature (unless otherwise noted)

PARAMETER	TEST CONDITIONS	2N3244	2N3245	2N3467	2N3468	UNIT
		MIN MAX	MIN MAX	MIN MAX	MIN MAX	
$V_{(BR)CBO}$ Collector-Base Breakdown Voltage	$I_C = -10 \mu A, I_E = 0$	-40	-50	-40	-50	V
$V_{(BR)CEO}$ Collector-Emitter Breakdown Voltage	$I_C = -10 \text{ mA}, I_B = 0$, See Note 4	-40	-50	-40	-50	V
$V_{(BR)EBO}$ Emitter-Base Breakdown Voltage	$I_E = -10 \mu A, I_C = 0$	-5	-5	-5	-5	V
I_{CBO} Collector Cutoff Current	$V_{CB} = -30 \text{ V}, I_E = 0$	-50		-100	-100	nA
	$V_{CB} = -30 \text{ V}, I_E = 0, T_A = 100^\circ\text{C}$			-15	-15	μA
	$V_{CB} = -50 \text{ V}, I_E = 0$		-50			nA
I_{CEV} Collector Cutoff Current	$V_{CE} = -30 \text{ V}, V_{BE} = 3 \text{ V}$	-50	-50	-100	-100	nA
I_{BEV} Base Cutoff Current	$V_{CE} = -30 \text{ V}, V_{BE} = 3 \text{ V}$	80	80	120	120	nA
I_{EBO} Emitter Cutoff Current	$V_{EB} = -4 \text{ V}, I_C = 0$	-30	-30			nA
h_{FE} Static Forward Current Transfer Ratio	$V_{CE} = -1 \text{ V}, I_C = -150 \text{ mA}$	60	35	40	25	
	$V_{CE} = -1 \text{ V}, I_C = -500 \text{ mA}$	50 150	30 90	40 120	25 75	
	$V_{CE} = -5 \text{ V}, I_C = -750 \text{ mA}$	25				
	$V_{CE} = -5 \text{ V}, I_C = -1 \text{ A}$		20	40	20	
V_{BE} Base-Emitter Voltage	$I_B = -15 \text{ mA}, I_C = -150 \text{ mA}$	-1.1	-1.1	-1	-1	V
	$I_B = -50 \text{ mA}, I_C = -500 \text{ mA}$	-0.75 -1.5	-0.75 -1.5	-0.8 -1.2	-0.8 -1.2	V
	$I_B = -75 \text{ mA}, I_C = -750 \text{ mA}$	-2				V
	$I_B = -100 \text{ mA}, I_C = -1 \text{ A}$		-2	-1.6	-1.6	V
$V_{CE(sat)}$ Collector-Emitter Saturation Voltage	$I_B = -15 \text{ mA}, I_C = -150 \text{ mA}$	-0.3	-0.35	-0.3	-0.35	V
	$I_B = -50 \text{ mA}, I_C = -500 \text{ mA}$	-0.5	-0.6	-0.5	-0.6	V
	$I_B = -100 \text{ mA}, I_C = -1 \text{ A}$	-1	-1.2	-1	-1.2	V
f_T Transition Frequency	$V_{CE} = -10 \text{ V}, I_C = -50 \text{ mA}$, See Note 5	175	150	175	150	MHz
C_{obo} Common-Base Open-Circuit Output Capacitance	$V_{CB} = -10 \text{ V}, I_E = 0, f = 100 \text{ kHz}$	25	25	25	25	pF
C_{ibo} Common-Base Open-Circuit Input Capacitance	$V_{EB} = -0.5 \text{ V}, I_C = 0, f = 100 \text{ kHz}$	100	100	100	100	pF

NOTES: 4. These parameters must be measured using pulse techniques. $t_p = 300 \mu s$, duty cycle $\leq 2\%$.

5. To obtain f_T , the $|h_{fe}|$ response with frequency is extrapolated at the rate of -6 dB per octave from $f = 100 \text{ MHz}$ to the frequency at which $|h_{fe}| = 1$.

*Indicates JEDEC registered data

TYPES 2N3244, 2N3245, 2N3467, 2N3468 P-N-P EPITAXIAL PLANAR SILICON TRANSISTORS

*switching characteristics at 25°C free-air temperature

PARAMETER	TEST CONDITIONS†	2N3244	2N3245	2N3467	2N3468	UNIT
		MAX	MAX	MAX	MAX	
t_d Delay Time	$I_C = -500 \text{ mA}$, $I_{B(1)} = -50 \text{ mA}$, $V_{BE(off)} = 2 \text{ V}$,	15	15	10	10	ns
t_r Rise Time	$R_L = 59 \Omega$, See Figure 1	35	40	30	30	ns
t_s Storage Time	$I_C = -500 \text{ mA}$, $I_{B(1)} = -50 \text{ mA}$, $I_{B(2)} = 50 \text{ mA}$,	140	120	60	60	ns
t_f Fall Time	$R_L = 59 \Omega$, See Figure 2	45	45	30	30	ns
Q_T Total Control Charge	$I_C = -500 \text{ mA}$, $I_B = -50 \text{ mA}$, See Figure 3	14	12	6	6	nC

† Voltages and current values shown are nominal, exact values vary slightly with transistor parameters. Nominal base current for delay and rise times is calculated using the minimum values of V_{BE} . Nominal base currents for storage and fall times are calculated using the maximum value of V_{BE} .

*PARAMETER MEASUREMENT INFORMATION

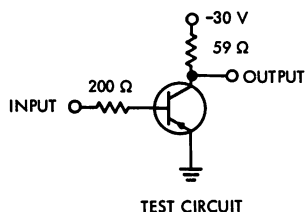

TEST CIRCUIT

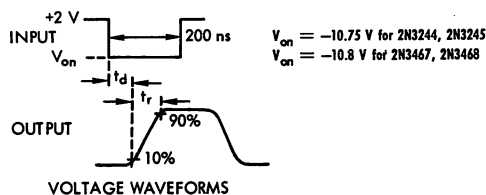

VOLTAGE WAVEFORMS

FIGURE 1 — DELAY AND RISE TIMES

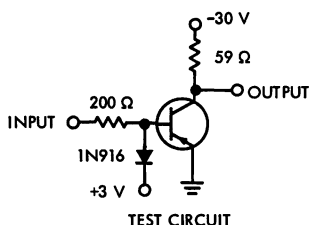

TEST CIRCUIT

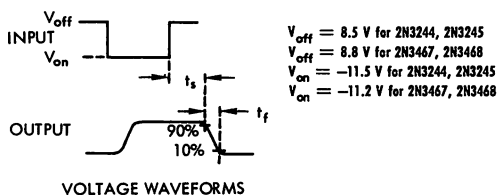

VOLTAGE WAVEFORMS

FIGURE 2 — STORAGE AND FALL TIMES

$C = 1400 \text{ pF}$ for 2N3244
 $C = 1200 \text{ pF}$ for 2N3245
 $C = 600 \text{ pF}$ for 2N3467, 2N3468

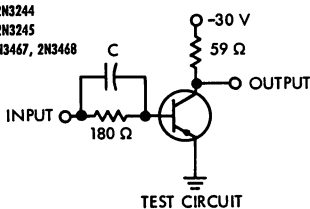

TEST CIRCUIT

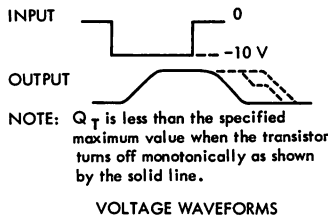

VOLTAGE WAVEFORMS

FIGURE 3 — TOTAL CONTROL CHARGE

NOTES: a. The input waveforms have the following characteristics:

For measuring delay and rise times: $t_r \leq 2 \text{ ns}$, $t_p = 200 \text{ ns}$, duty cycle = 2%.

For measuring storage and fall times: $t_s \leq 5 \text{ ns}$, $t_p = 2 \text{ to } 500 \mu\text{s}$, duty cycle = 2%.

For measuring Q_T : $t_f \leq 10 \text{ ns}$, $t_p = 10 \mu\text{s}$, duty cycle = 2%.

b. Waveforms are monitored on an oscilloscope with the following characteristics: $t_r \leq 1 \text{ ns}$, $R_{in} \geq 100 \text{ k}\Omega$, $C_{in} \leq 7 \text{ pF}$.

*Indicates JEDEC registered data

TYPES 2N3244, 2N3245, 2N3467, 2N3468

P-N-P EPITAXIAL PLANAR SILICON TRANSISTORS

TYPICAL CHARACTERISTICS

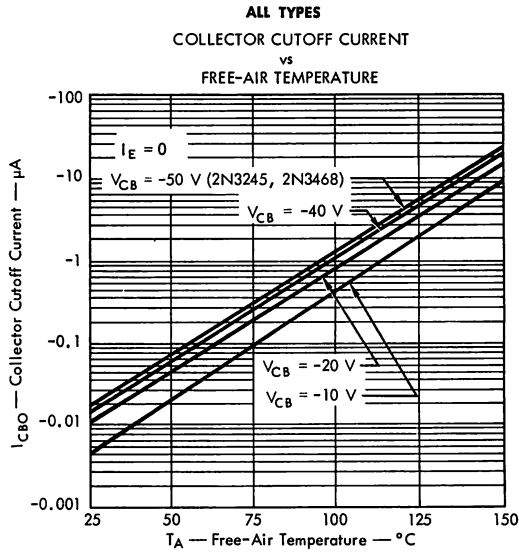

FIGURE 4

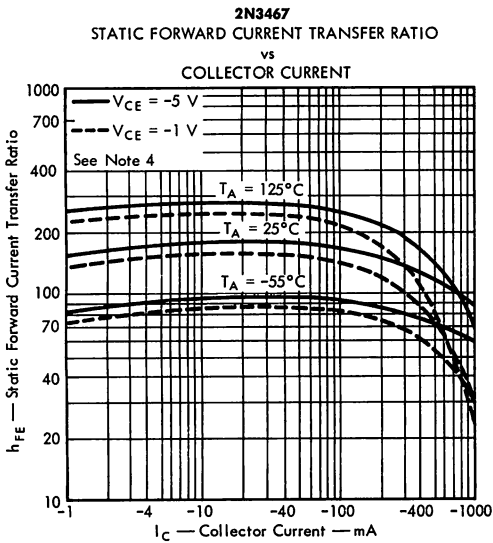

FIGURE 5

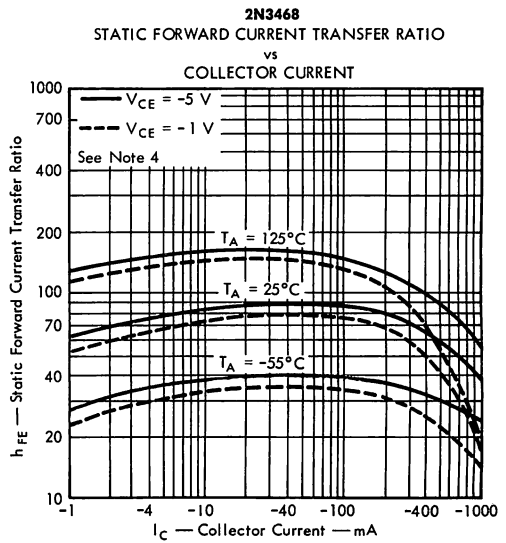

FIGURE 6

NOTE 4: These parameters must be measured using pulse techniques. $I_p = 300 \mu s$, duty cycle $\leq 2\%$.

TYPES 2N3244, 2N3245, 2N3467, 2N3468 P-N-P EPITAXIAL PLANAR SILICON TRANSISTORS

TYPICAL CHARACTERISTICS

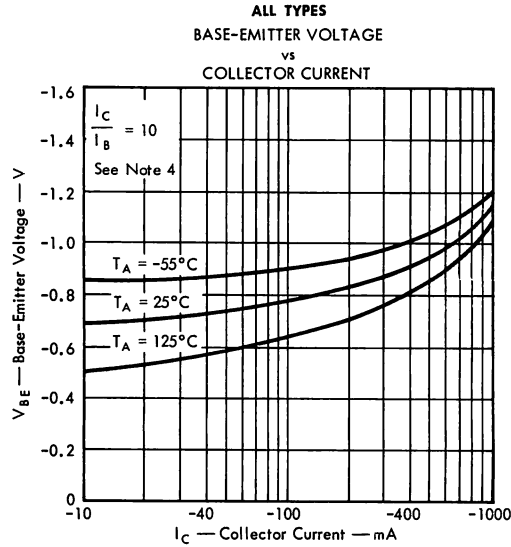

FIGURE 7

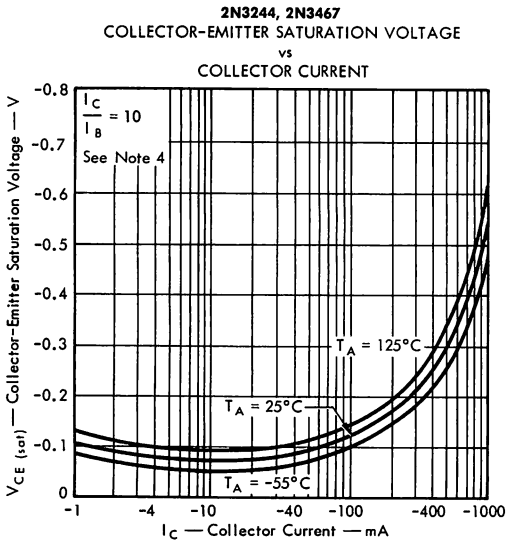

FIGURE 8

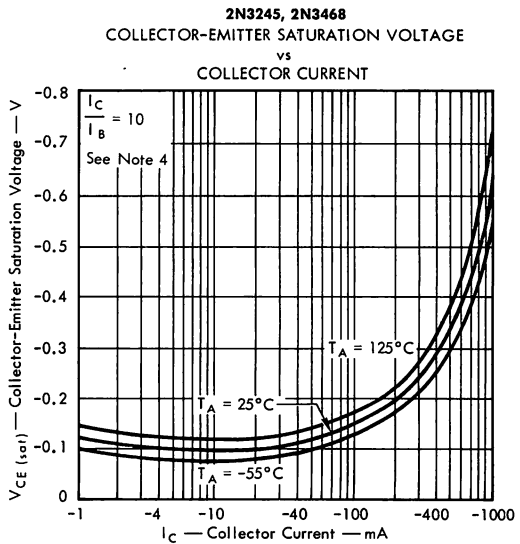

FIGURE 9

NOTE 4: These parameters must be measured using pulse techniques. $t_p = 300 \mu s$, duty cycle $\leq 2\%$.

TYPES 2N3244, 2N3245, 2N3467, 2N3468 P-N-P EPITAXIAL PLANAR SILICON TRANSISTORS

TYPICAL CHARACTERISTICS

2N3467, 2N3468
SMALL-SIGNAL COMMON-EMITTER
FORWARD CURRENT TRANSFER RATIO

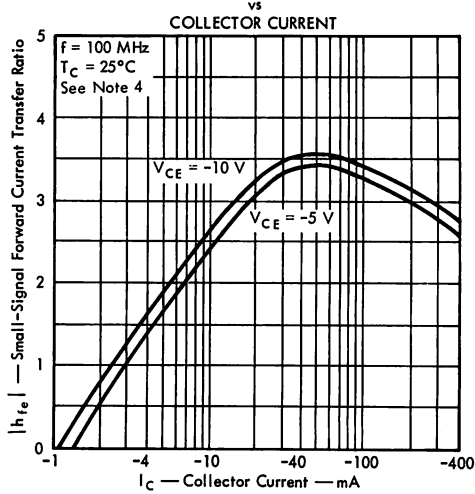

FIGURE 10

ALL TYPES
COMMON-BASE OPEN-CIRCUIT INPUT CAPACITANCE
AND EMITTER-BASE CAPACITANCE
vs
EMITTER-BASE VOLTAGE

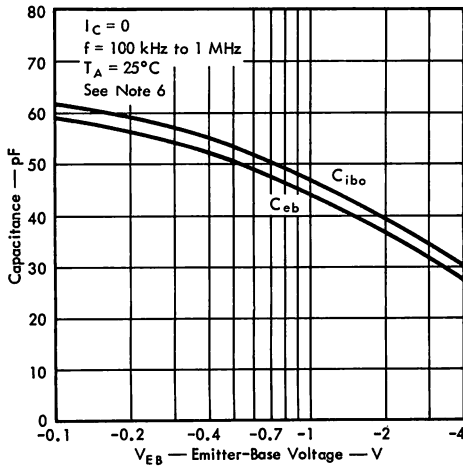

FIGURE 11

2N3467, 2N3468
COMMON-BASE OPEN-CIRCUIT OUTPUT CAPACITANCE
AND COLLECTOR-BASE CAPACITANCE
vs
COLLECTOR-BASE VOLTAGE

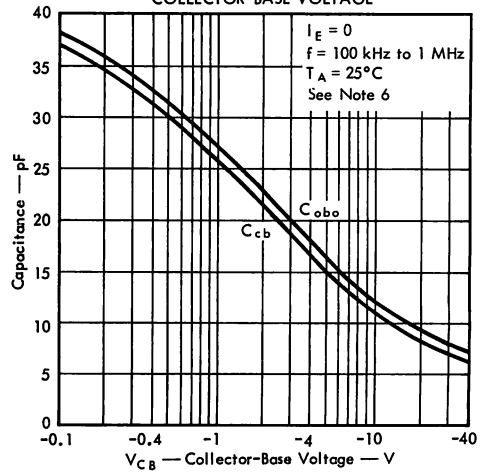

FIGURE 12

NOTES: 4. These parameters must be measured using pulse techniques. $t_p = 300 \mu\text{s}$, duty cycle $\leq 2\%$.

6. C_{cb} and C_{ob} measurements employ a three-terminal capacitance bridge incorporating a guard circuit. The third electrode (emitter or collector, respectively) is connected to the guard terminal of the bridge. C_{obc} and C_{ibo} are measured with the third electrode floating.

TYPES 2N3250, 2N3250A, 2N3251, 2N3251A P-N-P EPITAXIAL PLANAR SILICON TRANSISTORS



DESIGNED FOR LOW-POWER SATURATED-SWITCHING AND AMPLIFIER APPLICATIONS

- Low-Level h_{FE} : 80 Min at 100 μ A (2N3251 and 2N3251A)
- Made with TRI-REL[†] Redundant Stabilization (Field-Relief Electrode[‡], Special Oxide Passivation, Annular Guard Ring[§])

***mechanical data**

THE COLLECTOR IS IN ELECTRICAL CONTACT WITH THE CASE.

ALL JEDEC TO-18 DIMENSIONS AND NOTES ARE APPLICABLE.

ALL DIMENSIONS ARE IN INCHES UNLESS OTHERWISE SPECIFIED

***absolute maximum ratings at 25°C free-air temperature (unless otherwise noted)**

	<table style="font-size: small;"> <tr> <td>2N3250</td> <td>2N3250A</td> </tr> <tr> <td>2N3251</td> <td>2N3251A</td> </tr> <tr> <td>-50 V</td> <td>-60 V</td> </tr> <tr> <td>-40 V</td> <td>-60 V</td> </tr> <tr> <td>-5 V</td> <td>-5 V</td> </tr> <tr> <td>← -200 mA →</td> <td></td> </tr> <tr> <td>← 0.36 W →</td> <td></td> </tr> <tr> <td>← 1.2 W →</td> <td></td> </tr> <tr> <td>-65°C to 200°C</td> <td></td> </tr> <tr> <td>← 300°C →</td> <td></td> </tr> </table>	2N3250	2N3250A	2N3251	2N3251A	-50 V	-60 V	-40 V	-60 V	-5 V	-5 V	← -200 mA →		← 0.36 W →		← 1.2 W →		-65°C to 200°C		← 300°C →	
2N3250	2N3250A																				
2N3251	2N3251A																				
-50 V	-60 V																				
-40 V	-60 V																				
-5 V	-5 V																				
← -200 mA →																					
← 0.36 W →																					
← 1.2 W →																					
-65°C to 200°C																					
← 300°C →																					
Collector-Base Voltage																					
Collector-Emitter Voltage (See Note 1)																					
Emitter-Base Voltage																					
Continuous Collector Current																					
Continuous Device Dissipation at (or below) 25°C Free-Air Temperature (See Note 2)																					
Continuous Device Dissipation at (or below) 25°C Case Temperature (See Note 3)																					
Storage Temperature Range																					
Lead Temperature $\frac{1}{16}$ Inch from Case for 60 Seconds																					

***electrical characteristics at 25°C free-air temperature**

PARAMETER	TEST CONDITIONS	2N3250	2N3250A	2N3251	2N3251A	UNIT				
		MIN	MAX	MIN	MAX		MIN	MAX		
$V_{(BR)CBO}$ Collector-Base Breakdown Voltage	$I_C = -10 \mu A, I_E = 0$	-50	-60	-50	-60	V				
$V_{(BR)CEO}$ Collector-Emitter Breakdown Voltage	$I_C = -10 mA, I_B = 0$, See Note 4	-40	-60	-40	-60	V				
$V_{(BR)EBO}$ Emitter-Base Breakdown Voltage	$I_E = -10 \mu A, I_C = 0$	-5	-5	-5	-5	V				
I_{CEV} Collector Cutoff Current	$V_{CE} = -40 V, V_{BE} = 3 V$	-20	-20	-20	-20	nA				
I_{BEV} Base Cutoff Current	$V_{CE} = -40 V, V_{BE} = 3 V$	50	50	50	50	nA				
h_{FE} Static Forward Current Transfer Ratio	$V_{CE} = -1 V, I_C = -0.1 mA$	40	40	80	80					
	$V_{CE} = -1 V, I_C = -1 mA$	45	45	90	90					
	$V_{CE} = -1 V, I_C = -10 mA$	50	150	50	150	100	300			
	$V_{CE} = -1 V, I_C = -50 mA$	15	15	30	30					
V_{BE} Base-Emitter Voltage	$I_B = -1 mA, I_C = -10 mA$	-0.6	-0.9	-0.6	-0.9	V				
	$I_B = -5 mA, I_C = -50 mA$	-1.2	-1.2	-1.2	-1.2	V				
$V_{CE(sat)}$ Collector-Emitter Saturation Voltage	$I_B = -1 mA, I_C = -10 mA$	-0.25	-0.25	-0.25	-0.25	V				
	$I_B = -5 mA, I_C = -50 mA$	-0.5	-0.5	-0.5	-0.5	V				
h_{io} Small-Signal Common-Emitter Input Impedance	$V_{CE} = -10 V,$ $I_C = -1 mA,$ $f = 1 kHz$	1	6	1	6	2	12	2	12	k Ω
h_{fe} Small-Signal Common-Emitter Forward Current Transfer Ratio		50	200	50	200	100	400	100	400	
h_{ro} Small-Signal Common-Emitter Reverse Voltage Transfer Ratio		10×10^{-4}	10×10^{-4}	20×10^{-4}	20×10^{-4}					
h_{oe} Small-Signal Common-Emitter Output Admittance		4	40	4	40	10	60	10	60	μ mho

- NOTES: 1. These values apply between 0 and 200 mA collector current when the base-emitter diode is open-circuited.
 2. Derate linearly to 200°C free-air temperature at the rate of 2.06 mW/deg.
 3. Derate linearly to 200°C case temperature at the rate of 6.9 mW/deg.
 4. These parameters must be measured using pulse techniques. $t_p = 300 \mu s$, duty cycle $\leq 2\%$.

[†] Trademark of Texas Instruments
[‡] Patent Pending
[§] Patented by Texas Instruments
^{*} Indicates JEDEC registered data

TYPES 2N3250, 2N3250A, 2N3251, 2N3251A
 BULLETIN NO. DL-5 679650, MARCH 1967
 REPLACES BULLETIN NO. DL-5 657970, AUGUST 1965



TYPES 2N3250, 2N3250A, 2N3251, 2N3251A

P-N-P EPITAXIAL PLANAR SILICON TRANSISTORS

*electrical characteristics at 25°C free-air temperature (continued)

PARAMETER	TEST CONDITIONS	2N3250 2N3250A		2N3251 2N3251A		UNIT
		MIN	MAX	MIN	MAX	
$ h_{fe} $	Small-Signal Common-Emitter Forward Current Transfer Ratio	$V_{CE} = -20 \text{ V}, I_C = -10 \text{ mA}, f = 100 \text{ MHz}$		2.5	3	
f_T	Transition Frequency	$V_{CE} = -20 \text{ V}, I_C = -10 \text{ mA}$, See Note 5		250	300	MHz
C_{obo}	Common-Base Open-Circuit Output Capacitance	$V_{CB} = -10 \text{ V}, I_E = 0, f = 100 \text{ kHz}$		6	6	pF
C_{ibo}	Common-Base Open-Circuit Input Capacitance	$V_{EB} = -1 \text{ V}, I_C = 0, f = 100 \text{ kHz}$		8	8	pF
$r_b' C_c$	Collector-Base Time Constant	$V_{CE} = -20 \text{ V}, I_C = -10 \text{ mA}, f = 31.8 \text{ MHz}$		250	250	ps

NOTE 5: To obtain f_T , the $|h_{fe}|$ response with frequency is extrapolated at the rate of -6 dB per octave from $f = 100 \text{ MHz}$ to the frequency at which $|h_{fe}| = 1$.

*operating characteristics at 25°C free-air temperature

PARAMETER	TEST CONDITIONS	2N3250 2N3250A	2N3251 2N3251A	UNIT
		MAX	MAX	
NF	Spot Noise Figure	$V_{CE} = -5 \text{ V}, I_C = -100 \mu\text{A}, R_G = 1 \text{ k}\Omega, f = 100 \text{ Hz}$		6

*switching characteristics at 25°C free-air temperature

PARAMETER	TEST CONDITIONS†	2N3250 2N3250A	2N3251 2N3251A	UNIT
		MAX	MAX	
t_d	Delay Time	$I_C = -10 \text{ mA}, I_{B(1)} = -1 \text{ mA}, V_{BE(off)} = 0.5 \text{ V}$		35
t_r	Rise Time	$R_L = 275 \Omega$, See Figure 1		35
t_s	Storage Time	$I_C = -10 \text{ mA}, I_{B(1)} = -1 \text{ mA}, I_{B(2)} = 1 \text{ mA}$		175
t_f	Fall Time	$R_L = 275 \Omega$, See Figure 2		50

†Voltage and current values shown are nominal; exact values vary slightly with transistor parameters. Nominal base current for delay and rise times is calculated using the minimum value of V_{BE} . Nominal base currents for storage and fall times are calculated using the maximum value of V_{BE} .

*PARAMETER MEASUREMENT INFORMATION

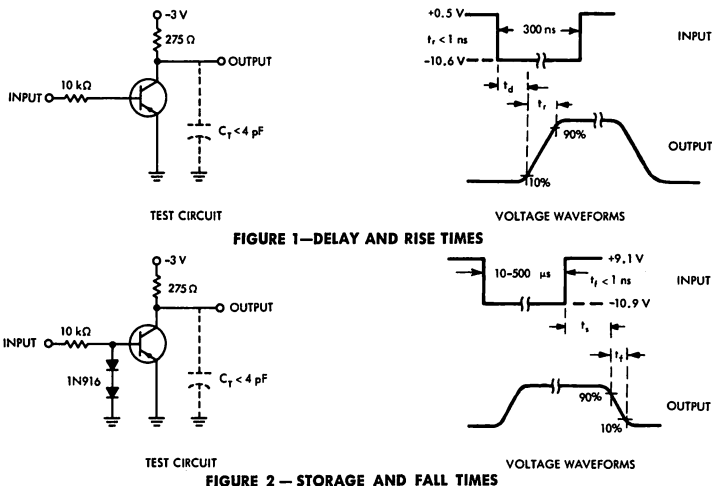

NOTES: a. The input waveforms are supplied by a generator with the following characteristics: $Z_{out} = 50 \Omega$, duty cycle = 2%.
b. Waveforms are monitored on an oscilloscope with the following characteristics: $t_r \leq 1 \text{ ns}$, $R_{in} \geq 100 \text{ k}\Omega$.

*Indicates JEDEC registered data

TYPE 2N3304 P-N-P EPITAXIAL PLANAR SILICON TRANSISTOR



DESIGNED FOR HIGH-SPEED SWITCHING APPLICATIONS

• High f_T — 500 Mc Min

***mechanical data**

3 LEADS 0.019 DIA
0.310
0.170
0.030 MAX
0.220 DIA
0.195 DIA
0.200 DIA
0.178 DIA
0.500 MIN
0.100
0.050
0.050
0.100
0.050
0.050
0.050
0.050
45°
3 - COLLECTOR
2 - BASE
1 - EMITTER
ALL DIMENSIONS ARE IN INCHES UNLESS OTHERWISE SPECIFIED

THE COLLECTOR IS IN ELECTRICAL CONTACT WITH THE CASE.

ALL JEDEC TO-18 DIMENSIONS AND NOTES ARE APPLICABLE.

TYPE 2N3304
BULLETIN NO. DI-S-657508, MARCH 1965

***absolute maximum ratings at 25°C free-air temperature (unless otherwise noted)**

Collector-Base Voltage	-6 v
Collector-Emitter Voltage (See Note 1)	-6 v
Emitter-Base Voltage	-4 v
Continuous Device Dissipation at (or below) 25°C Free-Air Temperature (See Note 2)	0.3 w
Continuous Device Dissipation at (or below) 100°C Case Temperature (See Note 3)	0.5 w
Storage Temperature Range	-65°C to 200°C
Lead Temperature $\frac{1}{8}$ Inch from Case for 60 Seconds	300°C

***electrical characteristics at 25°C free-air temperature (unless otherwise noted)**

PARAMETER	TEST CONDITIONS	MIN	MAX	UNIT
$V_{(BR)CBO}$ Collector-Base Breakdown Voltage	$I_C = -100 \mu A, I_E = 0$	-6		v
$V_{(BR)CEO}$ Collector-Emitter Breakdown Voltage	$I_C = -10 \text{ ma}, I_B = 0, \text{ See Note 4}$	-6		v
$V_{(BR)CES}$ Collector-Emitter Breakdown Voltage	$I_C = -100 \mu A, V_{BE} = 0$	-6		v
$V_{(BR)EBO}$ Emitter-Base Breakdown Voltage	$I_E = -100 \mu A, I_C = 0$	-4		v
I_{CES} Collector Cutoff Current	$V_{CE} = -3 \text{ v}, V_{BE} = 0$		-10	na
	$V_{CE} = -3 \text{ v}, V_{BE} = 0, T_A = 125^\circ C$		-10	μA
I_B Base Current	$V_{CE} = -3 \text{ v}, V_{BE} = 0$		10	na
h_{FE} Static Forward Current Transfer Ratio	$V_{CE} = -0.5 \text{ v}, I_C = -1 \text{ ma}$		15	
	$V_{CE} = -0.3 \text{ v}, I_C = -10 \text{ ma}$		30	120
	$V_{CE} = -0.3 \text{ v}, I_C = -10 \text{ ma}, T_A = -55^\circ C$		12	
	$V_{CE} = -1 \text{ v}, I_C = -50 \text{ ma}, \text{ See Note 4}$		20	
V_{BE} Base-Emitter Voltage	$I_B = -100 \mu A, I_C = -1 \text{ ma}$	-0.7	-0.8	v
	$I_B = -1 \text{ ma}, I_C = -10 \text{ ma}$	-0.8	-1	v
	$I_B = -5 \text{ ma}, I_C = -50 \text{ ma}, \text{ See Note 4}$		-1.5	v
$V_{CE(sat)}$ Collector-Emitter Saturation Voltage	$I_B = -100 \mu A, I_C = -1 \text{ ma}$		-0.15	v
	$I_B = -1 \text{ ma}, I_C = -10 \text{ ma}$		-0.16	v
	$I_B = -1 \text{ ma}, I_C = -10 \text{ ma}, T_A = 125^\circ C$		-0.23	v
	$I_B = -5 \text{ ma}, I_C = -50 \text{ ma}, \text{ See Note 4}$		-0.5	v
$ h_{fo} $ Small-Signal Common-Emitter Forward Current Transfer Ratio	$V_{CE} = -5 \text{ v}, I_C = -10 \text{ ma}, f = 100 \text{ Mc}$	5		
C_{obo} Common-Base Open-Circuit Output Capacitance	$V_{CB} = -5 \text{ v}, I_E = 0, f = 140 \text{ kc}$		3.5	pf
C_{ibo} Common-Base Open-Circuit Input Capacitance	$V_{EB} = -0.5 \text{ v}, I_C = 0, f = 140 \text{ kc}$		3.5	pf

- NOTES: 1. This value applies between 10 na and 10 ma collector current when the base-emitter diode is open-circuited.
 2. Derate linearly to 200°C free-air temperature at the rate of 1.72 mw/C°.
 3. Derate linearly to 200°C case temperature at the rate of 5 mw/C°.
 4. These parameters must be measured using pulse techniques. PW = 300 μ sec, Duty Cycle \leq 2%.

*Indicates JEDEC registered data



TYPE 2N3304

P-N-P EPITAXIAL PLANAR SILICON TRANSISTOR

*switching characteristics at 25°C free-air temperature

PARAMETER	TEST CONDITIONS†	MAX	UNIT
t_{on} Turn-On Time	$I_C = -10 \text{ ma}$, $I_{B(1)} = -0.5 \text{ ma}$, $I_{B(2)} = 0.5 \text{ ma}$, $V_{BE(off)} = 1.5 \text{ v}$, $R_L = 130 \Omega$, See Figure 1	60	nsec
t_{off} Turn-Off Time		60	nsec
t_s Storage Time	$I_C = -10 \text{ ma}$, $I_{B(1)} = -10 \text{ ma}$, $I_{B(2)} = 14 \text{ ma}$, See Figure 2	30	nsec

†Voltage and current values shown are nominal; exact values vary slightly with transistor parameters.

*PARAMETER MEASUREMENT INFORMATION

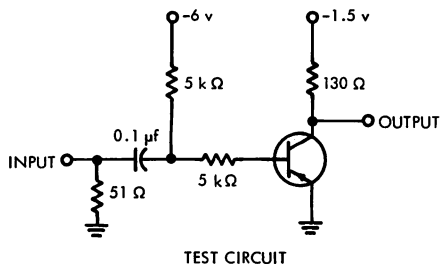

FIGURE 1 — TURN-ON AND TURN-OFF TIMES

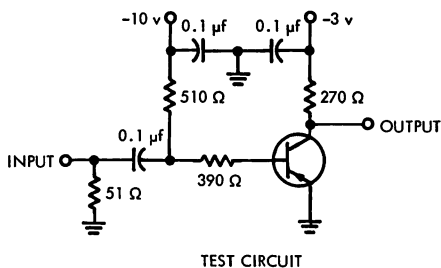

FIGURE 2 — STORAGE TIME

NOTES: a. The input waveforms are supplied by a generator with the following characteristics: $Z_{out} = 50 \Omega$, $t_r, t_f \leq 1 \text{ nsec}$, $PW > 100 \text{ nsec}$.

b. Waveforms are monitored on an oscilloscope with the following characteristics: $t_r \leq 1 \text{ nsec}$, $R_{in} \geq 100 \text{ k}\Omega$, $C_{in} \leq 5 \text{ pf}$.

*Indicates JEDEC registered data

TYPES 2N3485, 2N3485A, 2N3486, 2N3486A P-N-P EPITAXIAL PLANAR SILICON TRANSISTORS



DESIGNED FOR HIGH-SPEED, MEDIUM-POWER SWITCHING AND GENERAL PURPOSE AMPLIFIER APPLICATIONS

- Electrically Identical to 2N2906, 2N2906A, 2N2907, and 2N2907A in Space-Saving TO-46 Package
- High Breakdown Voltage Combined With Very Low Saturation Voltage

*mechanical data

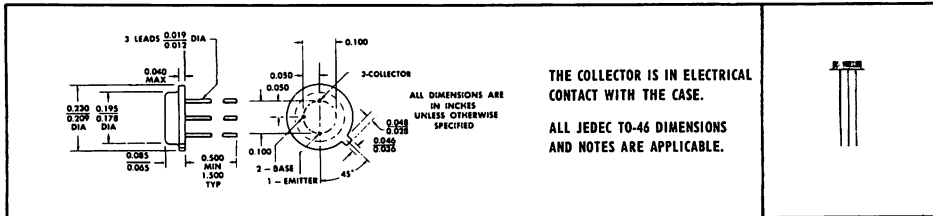

absolute maximum ratings at 25°C free-air temperature (unless otherwise noted)	2N3485	2N3485A	2N3486	2N3486A
*Collector-Base Voltage	-60 v	-60 v	-60 v	-60 v
*Collector-Emitter Voltage (See Note 1)	-40 v	-60 v	-40 v	-60 v
*Emitter-Base Voltage	-5 v	-5 v	-5 v	-5 v
*Collector Current	← 0.6 a →			
Continuous Device Dissipation at (or below) 25°C Free-Air Temperature (See Note 2)	← 0.4 w →			
*Continuous Device Dissipation at (or below) 25°C Case Temperature (See Note 3)	← 2 w →			
*Storage Temperature Range	← -65°C to +200°C →			
Lead Temperature 1/8 Inch from Case for 10 Seconds	← 300°C →			

*electrical characteristics at 25°C free-air temperature (unless otherwise noted)

PARAMETER	TEST CONDITIONS	2N3485	2N3486	2N3485A	2N3486A	UNIT
		MIN MAX	MIN MAX	MIN MAX	MIN MAX	
$V_{(BR)CBO}$ Collector-Base Breakdown Voltage	$I_C = -10 \mu a, I_E = 0$	-60	-60	-60	-60	v
$V_{(BR)CEO}$ Collector-Emitter Breakdown Voltage	$I_C = -10 ma, I_B = 0$, See Note 4	-40	-40	-60	-60	v
$V_{(BR)EBO}$ Emitter-Base Breakdown Voltage	$I_E = -10 \mu a, I_C = 0$	-5	-5	-5	-5	v
I_{CBO} Collector Cutoff Current	$V_{CB} = -50 v, I_E = 0$	-20	-20	-10	-10	na
I_{CEV} Collector Cutoff Current	$V_{CB} = -50 v, I_E = 0, T_A = 150^\circ C$	-50	-50	-50	-50	μa
I_{BEV} Base Cutoff Current	$V_{CE} = -30 v, V_{BE} = 0.5 v$	50	50	50	50	na
h_{FE} Static Forward Current Transfer Ratio	$V_{CE} = -10 v, I_C = -100 \mu a$	20	35	40	75	
	$V_{CE} = -10 v, I_C = -1 ma$	25	50	40	100	
	$V_{CE} = -10 v, I_C = -10 ma$	35	75	40	100	
	$V_{CE} = -10 v, I_C = -150 ma$	40	120	100	300	
	$V_{CE} = -10 v, I_C = -500 ma$	20	30	40	50	
V_{BE} Base-Emitter Voltage	$I_B = -15 ma, I_C = -150 ma$	-1.3	-1.3	-1.3	-1.3	v
	$I_B = -50 ma, I_C = -500 ma$	-2.6	-2.6	-2.6	-2.6	v
$V_{CE(sat)}$ Collector-Emitter Saturation Voltage	$I_B = -15 ma, I_C = -150 ma$	-0.4	-0.4	-0.4	-0.4	v
	$I_B = -50 ma, I_C = -500 ma$	-1.6	-1.6	-1.6	-1.6	v

NOTES: 1. This value applies between 0 and 100 ma collector current when the base-emitter diode is open circuited.

2. Derate linearly to 200°C free-air temperature at the rate of 2.28 mw/°C.

*Indicates JEDEC registered data.

3. Derate linearly to 200°C case temperature at the rate of 11.43 mw/°C.

4. These parameters must be measured using pulse techniques. $PW \leq 300 \mu sec$, Duty Cycle $\leq 2\%$.



TEXAS INSTRUMENTS
INCORPORATED
POST OFFICE BOX 5012 • DALLAS, TEXAS 75222

TYPES 2N3485, 2N3485A, 2N3486, 2N3486A

P-N-P EPITAXIAL PLANAR SILICON TRANSISTORS

*electrical characteristics at 25°C free-air temperature

PARAMETER	TEST CONDITIONS	ALL TYPES		UNIT
		MIN	MAX	
$ h_{fe} $	Small-Signal Common-Emitter Forward Current Transfer Ratio $V_{CE} = -20 \text{ v}$, $I_C = -50 \text{ ma}$, $f = 100 \text{ Mc}$	2		
C_{obo}	Common-Base Open-Circuit Output Capacitance $V_{CB} = -10 \text{ v}$, $I_E = 0$, $f = 100 \text{ kc}$	8		pf
C_{ibo}	Common-Base Open-Circuit Input Capacitance $V_{EB} = -2 \text{ v}$, $I_C = 0$, $f = 100 \text{ kc}$	30		pf

*switching characteristics at 25°C free-air temperature

PARAMETER	TEST CONDITIONS [†]	ALL TYPES		UNIT
		MAX		
t_d	Delay Time $I_C = -150 \text{ ma}$, $I_{B(1)} = -15 \text{ ma}$, $V_{BE(off)} = 0$, $R_L = 200 \Omega$, See Figure 1	10		nsec
t_r	Rise Time $I_C = -150 \text{ ma}$, $I_{B(1)} = -13 \text{ ma}$, $I_{B(2)} = 17 \text{ ma}$, $R_L = 37 \Omega$, See Figure 2	40		nsec
t_s	Storage Time	80		nsec
t_f	Fall Time	30		nsec

[†] Voltage and current values shown are nominal; exact values vary slightly with transistor parameters.

*PARAMETER MEASUREMENT INFORMATION

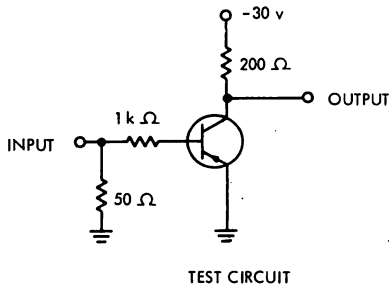

FIGURE 1—DELAY AND RISE TIMES

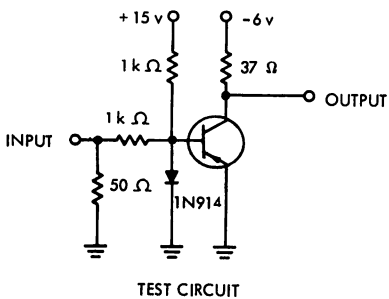

FIGURE 2—STORAGE AND FALL TIMES

NOTES: a. The input waveforms are supplied by a generator with the following characteristics: $Z_{out} = 50 \Omega$, $t_r \leq 2 \text{ nsec}$, $t_f \leq 2 \text{ nsec}$, $PW = 200 \text{ nsec}$, $PRR = 150 \text{ pps}$.
b. Waveforms are monitored on an oscilloscope with the following characteristics: $t_r \leq 5 \text{ nsec}$, $R_{in} = 10 \text{ M}\Omega$.

*Indicates JEDEC registered data.

TYPES 2N3494, 2N3495, 2N3496, 2N3497 P-N-P EPITAXIAL PLANAR SILICON TRANSISTORS



TYPES 2N3494, 2N3495, 2N3496, 2N3497
BULLETIN NO. DLS-679668, MARCH 1967

HIGH-VOLTAGE TRANSISTORS FULLY CHARACTERIZED FOR HIGH-SPEED, LOW-NOISE, MEDIUM-POWER SWITCHING AND GENERAL-PURPOSE AMPLIFIER APPLICATIONS

- h_{FE} Guaranteed from 100 μA to 100 mA
- Made with TRI-REL[†] Redundant Stabilization (Field-Relief Electrode[‡], Special Oxide Passivation, Annular Guard Ring[§])

*mechanical data

Device types 2N3494 and 2N3495 are in JEDEC TO-5 packages.
Device types 2N3496 and 2N3497 are in JEDEC TO-18 packages.

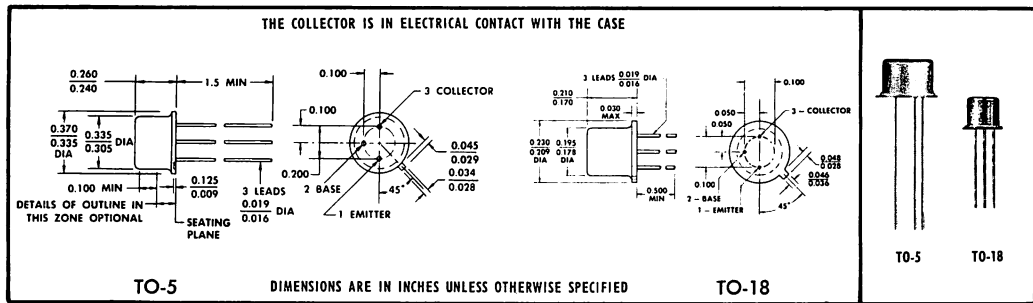

*absolute maximum ratings at 25°C free-air temperature (unless otherwise noted)

	2N3494	2N3495	2N3496	2N3497	UNIT
Collector-Base Voltage	-80	-120	-80	-120	V
Collector-Emitter Voltage (See Note 1)	-80	-120	-80	-120	V
Emitter-Base Voltage	-4.5	-4.5	-4.5	-4.5	V
Continuous Collector Current	-100	-100	-100	-100	mA
Continuous Device Dissipation at (or below) 25°C Free-Air Temperature (See Notes 2 and 3)	0.6	0.6	0.4	0.4	W
Storage Temperature Range	-65 to 200				°C
Lead Temperature 1/16 Inch from Case for 10 Seconds	300				°C

- NOTES: 1. These values apply between 0 and 100 mA collector current when the base-emitter diode is open-circuited.
2. Derate 2N3494 and 2N3495 linearly to 200°C free-air temperature at the rate of 3.43 mW/deg. See Figure 3.
3. Derate 2N3496 and 2N3497 linearly to 200°C free-air temperature at the rate of 2.28 mW/deg. See Figure 4.

†Trademark of Texas Instruments
‡Patent Pending
§Patented by Texas Instruments
*Indicates JEDEC registered data



TYPES 2N3494, 2N3495, 2N3496, 2N3497

P-N-P EPITAXIAL PLANAR SILICON TRANSISTORS

* electrical characteristics at 25°C free-air temperature

PARAMETER	TEST CONDITIONS	TO-5 →	2N3494		2N3495		UNIT
		TO-18 →	2N3496	2N3497	MIN	MAX	
$V_{(BR)CBO}$ Collector-Base Breakdown Voltage	$I_C = -10 \mu A, I_E = 0$		-80		-120		V
$V_{(BR)CEO}$ Collector-Emitter Breakdown Voltage	$I_C = -10 \text{ mA}, I_B = 0$, See Note 4		-80		-120		V
$V_{(BR)EBO}$ Emitter-Base Breakdown Voltage	$I_E = -10 \mu A, I_C = 0$		-4.5		-4.5		V
I_{CBO} Collector Cutoff Current	$V_{CB} = -50 \text{ V}, I_E = 0$		-0.1				μA
	$V_{CB} = -90 \text{ V}, I_E = 0$				-0.1		μA
I_{EBO} Emitter Cutoff Current	$V_{EB} = -3 \text{ V}, I_C = 0$		-25		-25		nA
h_{FE} Static Forward Current Transfer Ratio	$V_{CE} = -10 \text{ V}, I_C = -100 \mu A$	See Note 4	35		35		
	$V_{CE} = -10 \text{ V}, I_C = -1 \text{ mA}$		40		40		
	$V_{CE} = -10 \text{ V}, I_C = -10 \text{ mA}$		40		40		
	$V_{CE} = -10 \text{ V}, I_C = -50 \text{ mA}$		40		40		
	$V_{CE} = -10 \text{ V}, I_C = -100 \text{ mA}$		35				
V_{BE} Base-Emitter Voltage	$I_B = -1 \text{ mA}, I_C = -10 \text{ mA}$, See Note 4		-0.6	-0.9	-0.6	-0.9	V
$V_{CE(sat)}$ Collector-Emitter Saturation Voltage	$I_B = -1 \text{ mA}, I_C = -10 \text{ mA}$, See Note 4		-0.3		-0.35		V
h_{ie} Small-Signal Common-Emitter Input Impedance	$V_{CE} = -10 \text{ V},$ $I_C = -10 \text{ mA},$ $f = 1 \text{ kHz}$		0.1	1.2	0.1	1.2	k Ω
h_{fo} Small-Signal Common-Emitter Forward Current Transfer Ratio			40	300	40	300	
h_{re} Small-Signal Common-Emitter Reverse Voltage Transfer Ratio			2×10^{-4}		2×10^{-4}		
h_{oe} Small-Signal Common-Emitter Output Admittance			300		300		μmho
$ h_{fo} $ Small-Signal Common-Emitter Forward Current Transfer Ratio	$V_{CE} = -10 \text{ V}, I_C = -20 \text{ mA}, f = 100 \text{ MHz}$		2		1.5		
C_{obo} Common-Base Open-Circuit Output Capacitance	$V_{CB} = -10 \text{ V}, I_E = 0, f = 100 \text{ kHz}$		7		6		pF
C_{ibo} Common-Base Open-Circuit Input Capacitance	$V_{EB} = -2 \text{ V}, I_C = 0, f = 100 \text{ kHz}$		30		30		pF
$Re(h_{ie})$ Small-Signal Common-Emitter Input Resistance	$V_{CE} = -10 \text{ V}, I_C = -20 \text{ mA}, f = 300 \text{ MHz}$		30		30		Ω

NOTE 4: These parameters must be measured using pulse techniques. $t_p = 300 \mu\text{s}$, duty cycle $\leq 2\%$.

* switching characteristics at 25°C free-air temperature

PARAMETER	TEST CONDITIONS†	MAX	UNIT
t_{on} Turn-On Time	$I_C = -10 \text{ mA}, I_{B(1)} = -1 \text{ mA}, V_{BE(off)} = 0,$ $R_L = 3 \text{ k}\Omega,$ See Figure 1	300	ns
t_{off} Turn-Off Time	$I_C = -10 \text{ mA}, I_{B(1)} = -1 \text{ mA}, I_{B(2)} = 1 \text{ mA},$ $R_L = 3 \text{ k}\Omega,$ See Figure 2	1	μs

*Indicates JEDEC registered data

†Voltage and current values shown are nominal; exact values vary slightly with transistor parameters. Nominal base current for turn-on time is calculated using a minimum value of V_{BE} . Nominal base currents for turn-off times are calculated using the maximum value of V_{BE} .

TYPES 2N3494, 2N3495, 2N3496, 2N3497 P-N-P EPITAXIAL PLANAR SILICON TRANSISTORS

*PARAMETER MEASUREMENT INFORMATION

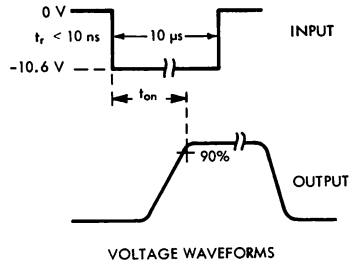
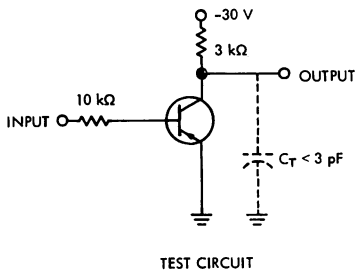

FIGURE 1 — TURN-ON TIME

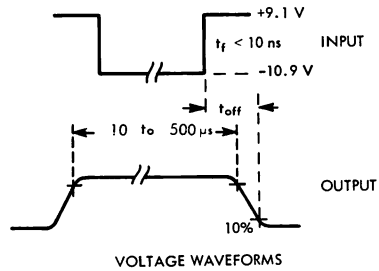
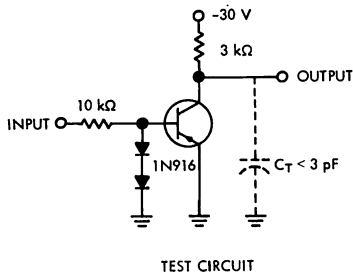

FIGURE 2 — TURN-OFF TIME

NOTES: a. The input waveforms are supplied by a generator with $Z_{out} = 50 \Omega$.

b. Waveforms are monitored on an oscilloscope with the following characteristics: $t_r \leq 10 \text{ ns}$, $R_{in} \geq 100 \text{ k}\Omega$.

*Indicates JEDEC registered data

THERMAL INFORMATION

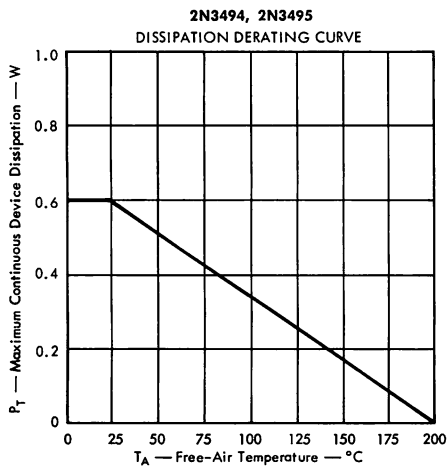
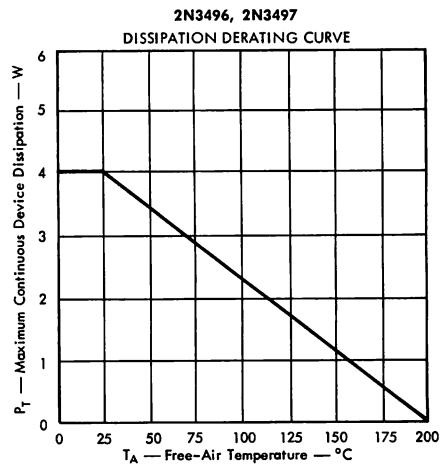
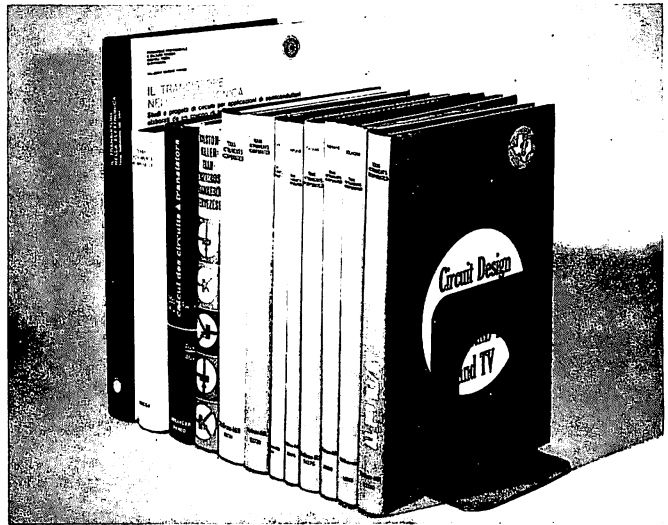

FIGURE 3



TI Microlibrary Books for Creative Circuit Designers



TRANSISTOR CIRCUIT DESIGN

523 Pages • 526 Illustrations • Published January '63 •
Shipping Weight 3-lb 4 oz • \$15.00

FIELD-EFFECT TRANSISTORS • L. J. SEVIN

138 Pages • 137 Illustrations • Published April '65 •
Shipping Weight 1-lb 10-oz • \$10.00

MOSFET IN CIRCUIT DESIGN • ROBERT H. CRAWFORD

136 Pages • 100 Illustrations • Published May '67 •
Shipping Weight 1-lb 10-oz • \$10.00

CIRCUIT DESIGN FOR AUDIO, AM/FM AND TV

352 Pages • 145 Illustrations • Published February '67 •
Shipping Weight 2-lb 8-oz • \$14.50

SILICON SEMICONDUCTOR TECHNOLOGY • W. R. RUNYAN

256 Pages • 301 Illustrations • Published May '65 •
Shipping Weight 2-lb 9-oz • \$16.50

DESIGN AND APPLICATION OF TRANSISTOR SWITCHING CIRCUITS • LOUIS DELHOM

278 Pages • 315 Illustrations • Published January '68 •
Shipping Weight 2-lb • \$14.50

SOLID STATE COMMUNICATIONS

366 Pages • 417 Illustrations • Published April '66 •
Shipping Weight 2-lb 9-oz • \$12.50

SOLID STATE ELECTRONICS • ROBERT G. HIBBERD

170 Pages • 90 Illustrations • Published January '68 •
Shipping Weight 1-lb 12-oz • \$8.95

Terms: F.O.B. destination, bulk rate.

Other than bulk rate,
indicate method of shipment,
add shipping charges.

Outside U.S.: Indicate method of shipment,
add shipping charges.

Send check or money order
(no purchase orders) to:

EXECUTIVE SERVICES DISTRIBUTION
Suite 148
8383 Stemmons Freeway
Dallas, Texas 75247

TYPE 2N3829 P-N-P EPITAXIAL PLANAR SILICON TRANSISTOR



TYPE 2N3829
BULLETIN NO. DLS-657455, MARCH 1965

DESIGNED FOR HIGH-SPEED SWITCHING APPLICATIONS

- Recommended for Complementary Use With 2N3014
- High f_T : 350 Mc min at 10 v, 30 ma
- Low Guaranteed $V_{CE(sat)}$: 0.18 v at 30 ma

***mechanical data**

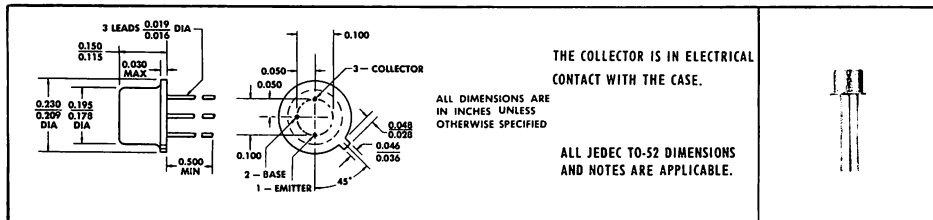

***absolute maximum ratings at 25°C free-air temperature (unless otherwise noted)**

Collector-Base Voltage	-35 v
Collector-Emitter Voltage (See Note 1)	-35 v
Collector-Emitter Voltage (See Note 2)	-20 v
Emitter-Base Voltage	-5 v
Continuous Collector Current	-200 ma
Peak Collector Current (See Note 3)	-500 ma
Continuous Device Dissipation at (or below) 25°C Free-Air Temperature (See Note 4)	.360 mw
Continuous Device Dissipation at (or below) 25°C Case Temperature (See Note 5)	1.2 w
Storage Temperature Range	-65°C to +200°C
Lead Temperature 1/8 Inch from Case for 10 Seconds	300°C

***electrical characteristics at 25°C free-air temperature (unless otherwise noted)**

PARAMETER		TEST CONDITIONS	MIN	MAX	UNIT
$V_{(BR)CBO}$	Collector-Base Breakdown Voltage	$I_C = -100 \mu A, I_E = 0$	-35		v
$V_{(BR)CEO}$	Collector-Emitter Breakdown Voltage	$I_C = -10 \text{ ma}, I_B = 0$, See Note 6	-20		v
$V_{(BR)CES}$	Collector-Emitter Breakdown Voltage	$I_C = -100 \mu A, V_{BE} = 0$	-35		v
$V_{(BR)EBO}$	Emitter-Base Breakdown Voltage	$I_E = -100 \mu A, I_C = 0$	-5		v
I_{CES}	Collector Cutoff Current	$V_{CE} = -20 \text{ v}, V_{BE} = 0$		-0.3	μA
		$V_{CE} = -20 \text{ v}, V_{BE} = 0, T_A = 125^\circ C$		-40	μA
I_B	Base Current	$V_{CE} = -20 \text{ v}, V_{BE} = 0$		0.3	μA
		$V_{CE} = -0.4 \text{ v}, I_C = -10 \text{ ma}$	25		
h_{FE}	Static Forward Current Transfer Ratio	$V_{CE} = -0.4 \text{ v}, I_C = -30 \text{ ma}$	30	120	
		$V_{CE} = -1 \text{ v}, I_C = -100 \text{ ma}$	25		
		$V_{CE} = -0.4 \text{ v}, I_C = -30 \text{ ma}, T_A = -55^\circ C$	12		
		See Note 6			
V_{BE}	Base-Emitter Voltage	$I_B = -1 \text{ ma}, I_C = -10 \text{ ma}$	-0.75	-0.85	v
		$I_B = -3 \text{ ma}, I_C = -30 \text{ ma}$	-0.75	-0.95	v
		$I_B = -10 \text{ ma}, I_C = -100 \text{ ma}$		-1.20	v
$V_{CE(sat)}$	Collector-Emitter Saturation Voltage	$I_B = -1 \text{ ma}, I_C = -10 \text{ ma}$		-0.18	v
		$I_B = -3 \text{ ma}, I_C = -30 \text{ ma}$		-0.18	v
		$I_B = -10 \text{ ma}, I_C = -100 \text{ ma}$		-0.35	v
		$I_B = -3 \text{ ma}, I_C = -30 \text{ ma}, T_A = 125^\circ C$		-0.25	v
		See Note 6			

- NOTES: 1. This value applies when the base-emitter diode is short-circuited.
 2. This value applies between 0 and 10 ma collector current when the base-emitter diode is open-circuited.
 3. This value applies for $PW \leq 10 \mu sec$, Duty Cycle $\leq 40\%$.
 4. Derate linearly to 175°C free-air temperature at the rate of 2.4 mw/°C.
 5. Derate linearly to 175°C case temperature at the rate of 8 mw/°C.
 6. These parameters must be measured using pulse techniques. $PW = 300 \mu sec$, Duty Cycle $\leq 2\%$.

*Indicates JEDEC registered data.



TYPE 2N3829

P-N-P EPITAXIAL PLANAR SILICON TRANSISTOR

*electrical characteristics at 25°C free-air temperature (unless otherwise noted)

PARAMETER	TEST CONDITIONS	MIN	MAX	UNIT
$ h_{fe} $ Small-Signal Common-Emitter Forward Current Transfer Ratio	$V_{CE} = -10$ v, $I_C = -30$ ma, $f = 100$ Mc	3.5		
C_{obo} Common-Base Open-Circuit Output Capacitance	$V_{CB} = -5$ v, $I_E = 0$, $f = 140$ kc		6	pf
C_{ibo} Common-Base Open-Circuit Input Capacitance	$V_{EB} = -0.5$ v, $I_C = 0$, $f = 140$ kc		10	pf

*operating characteristics at 25°C free-air temperature

PARAMETER	TEST CONDITIONS†	MIN	MAX	UNIT
t_d Delay Time	$I_C = -30$ ma, $I_{B(1)} = -3$ ma, $V_{BE(off)} = 0$, $R_L = 94 \Omega$, See Figure 1		10	nsec
t_r Rise Time			15	nsec
t_s Storage Time	$I_C = -30$ ma, $I_{B(1)} = -I_{B(2)} = -3$ ma, $R_L = 94 \Omega$, See Figure 1		50	nsec
t_f Fall Time			15	nsec
$V_{CE(ON)}‡$ Collector-Emitter Nonlatching Voltage	$I_{C(on)} = -200$ ma, $I_{B(on)} = -20$ ma, $I_{B(off)} = 0$, See Figure 2	-20		v

†Voltage and current values shown are nominal; exact values vary slightly with transistor parameters.

‡This characteristic is the highest value of collector supply voltage which may be safely used with a resistive-load switching circuit in which the collector current approaches -200 ma.

*PARAMETER MEASUREMENT INFORMATION

For t_d and t_r , $V_{BB} = 0$

For t_s and t_f , $V_{BB} = -7.25$ v

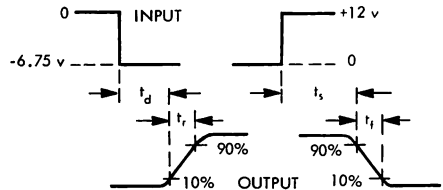
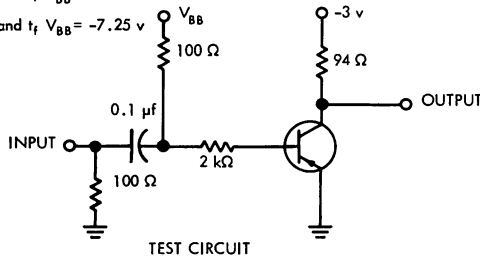

(See Notes a and b)
VOLTAGE WAVEFORMS

FIGURE 1

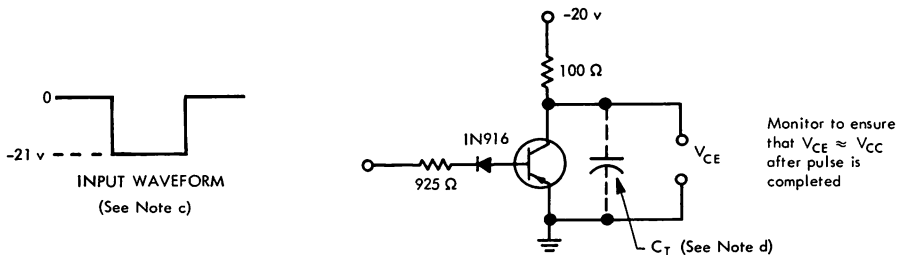

Monitor to ensure that $V_{CE} \approx V_{CC}$ after pulse is completed

FIGURE 2 — COLLECTOR-EMITTER NONLATCHING VOLTAGE TEST CIRCUIT

- NOTES: a. The input waveforms in Figure 1 are supplied by a pulse generator with the following characteristics: $Z_{out} = 50 \Omega$, $t_r \leq 1$ nsec, $PW \geq 300$ nsec, Duty Cycle $\leq 2\%$.
 b. Waveforms of Figure 1 are monitored on an oscilloscope with the following characteristics: $t_r \leq 1$ nsec, $R_{in} \geq 100$ k Ω , $C_{in} \leq 5$ pf.
 c. The input waveform in Figure 2 has the following characteristics: $PW \leq 10$ μ sec, Duty Cycle $\leq 2\%$.
 d. Total collector shunt capacitance $C_T \leq 15$ pf.

*Indicates JEDEC registered data.

TYPES 2N3962, 2N3963, 2N3964, 2N3965 P-N-P PLANAR SILICON TRANSISTORS



TYPES 2N3962 THRU 2N3965
BULLETIN NO. D.L.S. 679563, FEBRUARY 1967

FOR EXTREMELY LOW-LEVEL, LOW-NOISE, HIGH-GAIN, SMALL-SIGNAL AMPLIFIER APPLICATIONS

- Guaranteed h_{FE} at $10 \mu A$, $T_A = -55^\circ C$ and $25^\circ C$
- Guaranteed Low-Noise Characteristics at $20 \mu A$
- Made with TRI-REL[†] Redundant Stabilization (Field-Relief Electrode[‡], Special Oxide Passivation, Annular Guard Ring[§])

*mechanical data

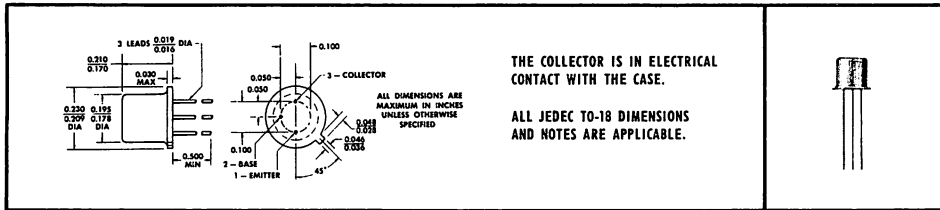

*absolute maximum ratings at 25°C free-air temperature (unless otherwise noted)

	2N3962	2N3965	2N3963	2N3964
Collector-Base Voltage	-60 V	-80 V	-45 V	-45 V
Collector-Emitter Voltage (See Note 1)	-60 V	-80 V	-45 V	-45 V
Emitter-Base Voltage	-6 V	-6 V	-6 V	-6 V
Continuous Collector Current	← -200 mA	→	→	→
Continuous Device Dissipation at (or below) 25°C Free-Air Temperature (See Note 2)	← 360 mW	→	→	→
Continuous Device Dissipation at (or below) 25°C Case Temperature (See Note 3)	← 1.2 W	→	→	→
Storage Temperature Range	← -65°C to 200°C	→	→	→
Lead Temperature 1/8 Inch from Case for 60 Seconds	← 300°C	→	→	→

NOTES: 1. These values apply between 10 μA and 5 mA collector current when the base-emitter diode is open-circuited.
 2. Derate linearly to 200°C free-air temperature at the rate of 2.06 mW/deg. See Figure 1.
 3. Derate linearly to 200°C case temperature at the rate of 6.85 mW/deg. See Figure 2.

†Trademark of Texas Instruments
 ‡Patent Pending
 §Patented by Texas Instruments
 *Indicates JEDEC registered data

TYPES 2N3962 THRU 2N3965

P-N-P PLANAR SILICON TRANSISTORS

*electrical characteristics at 25°C free-air temperature (unless otherwise noted)

PARAMETER	TEST CONDITIONS	2N3962		2N3963		2N3964		2N3965		UNIT
		MIN	MAX	MIN	MAX	MIN	MAX	MIN	MAX	
$V_{(BR)CBO}$ Collector-Base Breakdown Voltage	$I_C = -10 \mu A, I_E = 0$	-60		-80		-45		-60		V
$V_{(BR)CEO}$ Collector-Emitter Breakdown Voltage	$I_C = -5 \text{ mA}, I_B = 0$, See Note 4.	-60		-80		-45		-60		V
$V_{(BR)CES}$ Collector-Emitter Breakdown Voltage	$I_C = -10 \mu A, I_B = 0$	-60		-80		-45		-60		V
$V_{(BR)EBO}$ Emitter-Base Breakdown Voltage	$I_E = -10 \mu A, I_C = 0$	-6		-6		-6		-6		V
I_{CBO} Collector Cutoff Current	$V_{CB} = -40 \text{ V}, I_E = 0$					-10				nA
	$V_{CB} = -50 \text{ V}, I_E = 0$		-10					-10		nA
	$V_{CB} = -70 \text{ V}, I_E = 0$			-10						nA
I_{CES} Collector Cutoff Current	$V_{CE} = -40 \text{ V}, V_{EB} = 0$					-10				nA
	$V_{CE} = -50 \text{ V}, V_{EB} = 0$		-10					-10		nA
	$V_{CE} = -70 \text{ V}, V_{EB} = 0$			-10						nA
	$V_{CE} = -40 \text{ V}, V_{EB} = 0$	$T_A = 150^\circ\text{C}$					-10			μA
	$V_{CE} = -50 \text{ V}, V_{EB} = 0$		-10				-10			μA
$V_{CE} = -70 \text{ V}, V_{EB} = 0$			-10						μA	
I_{EBO} Emitter Cutoff Current	$V_{EB} = -4 \text{ V}, I_C = 0$		-10		-10		-10		-10	nA
h_{FE} Static Forward Current Transfer Ratio	$V_{CE} = -5 \text{ V}, I_C = -1 \mu\text{A}$	60		60		180		180		
	$V_{CE} = -5 \text{ V}, I_C = -10 \mu\text{A}$	100	300	100	300	250	500	250	500	
	$V_{CE} = -5 \text{ V}, I_C = -10 \mu\text{A}, T_A = -55^\circ\text{C}$	40		40		100		100		
	$V_{CE} = -5 \text{ V}, I_C = -100 \mu\text{A}$	100		100		250		250		
	$V_{CE} = -5 \text{ V}, I_C = -1 \text{ mA}$	100	450	100	450	250	600	250	600	
	$V_{CE} = -5 \text{ V}, I_C = -1 \text{ mA}, T_A = 100^\circ\text{C}$	600		600		800		800		
	$V_{CE} = -5 \text{ V}, I_C = -10 \text{ mA}$, See Note 4	100		100		200		200		
	$V_{CE} = -5 \text{ V}, I_C = -50 \text{ mA}$, See Note 4	90		90		180		180		
V_{BE} Base-Emitter Voltage	$I_C = -10 \text{ mA}, I_B = -0.5 \text{ mA}$		-0.9		-0.9		-0.9		-0.9	V
	$I_C = -50 \text{ mA}, I_B = -5 \text{ mA}$, See Note 4		-0.95		-0.95		-0.95		-0.95	V
$V_{CE(sat)}$ Collector-Emitter Saturation Voltage	$I_C = -10 \text{ mA}, I_B = -0.5 \text{ mA}$		-0.25		-0.25		-0.25		-0.25	V
	$I_C = -50 \text{ mA}, I_B = -5 \text{ mA}$, See Note 4		-0.4		-0.4		-0.4		-0.4	V
h_{ie} Small-Signal Common-Emitter Input Impedance	$V_{CE} = -5 \text{ V},$ $I_C = -1 \text{ mA},$ $f = 1 \text{ kHz}$	2.5	17	2.5	17	6	20	6	20	k Ω
h_{fe} Small-Signal Common-Emitter Forward Current Transfer Ratio		100	550	100	550	250	700	250	700	
h_{ro} Small-Signal Common-Emitter Reverse Voltage Transfer Ratio		10		10		10		10		$\times 10^{-4}$
h_{oe} Small-Signal Common-Emitter Output Admittance		5	40	5	40	5	50	5	50	μmho
$ h_{fe} $ Small-Signal Common-Emitter Forward Current Transfer Ratio	$V_{CE} = -5 \text{ V}, I_C = -0.5 \text{ mA}, f = 20 \text{ MHz}$	2	8	2	8	2.5	8	2.5	8	
C_{obo} Common-Base Open-Circuit Output Capacitance	$V_{CB} = -5 \text{ V}, I_E = 0, f = 1 \text{ MHz}$		6		6		6		6	pF
C_{ibo} Common-Base Open-Circuit Input Capacitance	$V_{EB} = -0.5 \text{ V}, I_C = 0, f = 1 \text{ MHz}$		15		15		15		15	pF

NOTE 4: These parameters must be measured using pulse techniques. $I_p = 300 \mu\text{s}$, duty cycle $\leq 1\%$.

*Indicates JEDEC registered data

TYPES 2N3962 THRU 2N3965 P-N-P PLANAR SILICON TRANSISTORS

*operating characteristics at 25°C free-air temperature

PARAMETER	TEST CONDITIONS	2N3962	2N3964	UNIT
		2N3963	2N3965	
NF Spot Noise Figure	$V_{CE} = -5\text{ V}, I_C = -20\ \mu\text{A}, R_G = 10\ \text{k}\Omega,$ $f = 10\ \text{Hz}, \text{Noise Bandwidth} = 2\ \text{Hz}$		8	dB
	$V_{CE} = -5\ \text{V}, I_C = -20\ \mu\text{A}, R_G = 10\ \text{k}\Omega,$ $f = 100\ \text{Hz}, \text{Noise Bandwidth} = 15\ \text{Hz}$	10	4	dB
	$V_{CE} = -5\ \text{V}, I_C = -20\ \mu\text{A}, R_G = 10\ \text{k}\Omega,$ $f = 1\ \text{kHz}, \text{Noise Bandwidth} = 150\ \text{Hz}$	3	2	dB
	$V_{CE} = -5\ \text{V}, I_C = -20\ \mu\text{A}, R_G = 10\ \text{k}\Omega,$ $f = 10\ \text{kHz}, \text{Noise Bandwidth} = 1.5\ \text{kHz}$	3	2	dB
NF Average Noise Figure	$V_{CE} = -5\ \text{V}, I_C = -20\ \mu\text{A}, R_G = 10\ \text{k}\Omega,$ $\text{Noise Bandwidth} = 15.7\ \text{kHz}, \text{See Note 5}$	3	2	dB

NOTE 5: Average Noise Figure is measured in an amplifier with low-frequency response down 3 dB at 10 Hz.

*Indicates JEDEC registered data

THERMAL INFORMATION

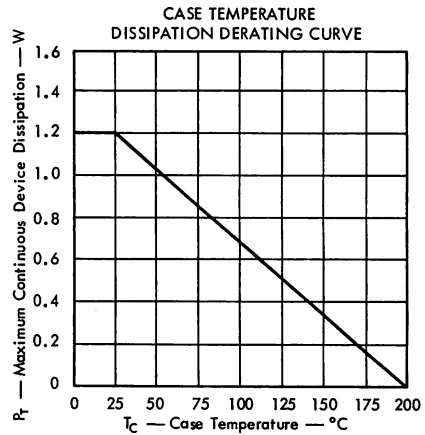
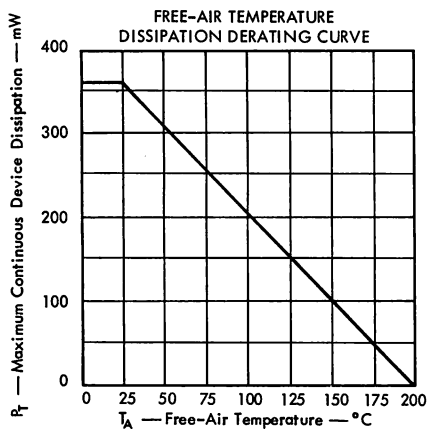

AUTHORIZED DISTRIBUTORS

FOR TEXAS INSTRUMENTS COMPONENTS GROUP

ALABAMA

ACK SEMICONDUCTORS INC.
3101 Fourth Ave. South/(205) FA 2-0588
Birmingham, Alabama 35233
ELECTRONIC WHOLESALERS, INC.
2310 Bob Wallace Avenue, S.W.
(205) 534-2461
Huntsville, Alabama 35805

ARIZONA

KIERULFF ELECTRONICS, INC.
2633 East Buckeye Road
(602) 273-7331
Phoenix, Arizona 85034
R. V. WEATHERFORD COMPANY
1917 North 25 Drive/(602) 272-7144
Carson Industrial Center
Phoenix, Arizona

CALIFORNIA

CALIFORNIA ELECTRONICS SUPPLY, INC.
1911 Armacost Avenue/(213) TR 9-0760
West Los Angeles, California 90025
KIERULFF ELECTRONICS, INC.
3969 E. Bayshore/(415) 968-6292
Palo Alto, California 94303
MILO OF CALIFORNIA
2060 India St./ (714) BE 2-8951
San Diego, California 92101
RADIO PRODUCTS SALES, INC.
1501 S. Hill St./ (213) RI 8-1271
Los Angeles, California 90015
R. V. WEATHERFORD COMPANY
1651 S. State College Blvd.
(714) KI 7-7521
Anaheim, California 92805
6921 San Fernando Rd./ (213) VI 9-3451
Glendale, California 91201
3240 Hillview Drive
Stanford Industrial Park
(415) DA 1-5373
Palo Alto, California 94304
TI SUPPLY COMPANY
1651 Tenth Street/(213) 393-6731
Santa Monica, California 90404

COLORADO

TI SUPPLY COMPANY
2186 S. Holly/(303) 757-7671
Denver, Colorado 80222

FLORIDA

ELECTRONIC WHOLESALERS, INC.
345 Graham Ave./ (305) 841-1550
Orlando, Florida 32814
9390 N. W. 27th Ave./ (305) OX 6-1620
Miami, Florida 33147

ILLINOIS

ALLIED ELECTRONICS CORPORATION
100 N. Western Ave./ (312) TA 9-9100
Chicago, Illinois 60680
MERQUIP ELECTRONICS, INC.
7701 No. Austin Ave./ (312) 965-7500
Skokie, Illinois 60076
NEWARK ELECTRONICS CORP.
500 N. Pulaski Road/(312) 638-4411
Chicago, Illinois 60624
TI SUPPLY COMPANY
7135 N. Barry Avenue/(312) 296-7187
Des Plaines, Illinois 60018

INDIANA

ESCO ELECTRONICS INC.
2442 N. Shadeland Ave./ (317) 357-8791
Indianapolis, Indiana 46219
RADIO DISTRIBUTING COMPANY
814 North Senate Avenue
(317) 637-5571
Indianapolis, Indiana 46204

IOWA

DEECO, INC.
618 First St., N. W./ (319) EM 5-7551
Cedar Rapids, Iowa 72405

LOUISIANA

ELECTRONIC PRODUCTS CORPORATION
3622 Toulouse St./ (504) HU 6-3777
New Orleans, Louisiana 70119

MARYLAND

ELECTRONIC WHOLESALERS, INC.
3200 Wilkens Ave./ (301) 646-3600
Baltimore, Maryland 21223
MILGRAY/WASHINGTON
5405 Lafayette Place/(202) 864-1111
Hyattsville, Maryland 20781

MASSACHUSETTS

DEMAMBRO ELECTRONICS
1095 Commonwealth Ave.
(617) 787-1200
Boston, Massachusetts 02215
TI SUPPLY COMPANY
480 Neponset Road/(617) 828-5020
Canton, Massachusetts 02021
LAFAYETTE INDUSTRIAL ELECTRONICS
1400 Worcester Rd./ (617) 969-6100
Natick, Massachusetts 01760
MILGRAY/NEW ENGLAND INC.
75 Terrace Hall Avenue/(617) 272-6800
Burlington, Massachusetts 02021

MICHIGAN

NEWARK-DETROIT ELECTRONICS, INC.
20700 Hubbell Ave./ (313) 548-0250
Detroit, Michigan 48237
NEWARK-INDUSTRIAL
ELECTRONICS CORP.
2114 So. Division/(616) CH 1-5695
Grand Rapids, Michigan 49507

MINNESOTA

STARK ELECTRONIC SUPPLY CO.
112 Third Avenue N/(612) FE 2-1325
Minneapolis, Minnesota 55401

MISSOURI

TI SUPPLY COMPANY
2916 Holmes Street/(816) 753-4750
Kansas City, Missouri 64109
ELECTRONIC COMPONENTS FOR
INDUSTRY
2605 South Hanley Rd./ (314) MI 7-5505
St. Louis, Missouri 63144

NEW JERSEY

GENERAL RADIO SUPPLY COMPANY, INC.
600 Penn St./ (609) WO 4-8560
Camden, New Jersey 08102
TI SUPPLY COMPANY
301 Central Ave./ (201) 382-6400
Clark, N. J. 07066

NEW MEXICO

KIERULFF ELECTRONICS, INC.
2524 Baylor Dr. S.E./ (505) 247-1055
Albuquerque, New Mexico 87108

NEW YORK

GENESEE RADIO & PARTS CO., INC.
2550 Delaware Ave./ (716) TR 3-9661
Buffalo, New York 14216
LAFAYETTE INDUSTRIAL ELECTRONICS
165-08 Liberty Ave./ (212) 658-5050
Jamaica, New York 11431
MILGRAY/NEW YORK
160 Varick St./ (212) YU 9-1600
New York, New York 10013
ROCHESTER RADIO SUPPLY CO., INC.
140 W. Main St./ (716) 454-7800
Rochester, New York 14614
TI SUPPLY COMPANY
4 Nevada Dr./ (516) 488-3300
New Hyde Park, L. I., N. Y. 11040
NORTH CAROLINA
ELECTRONIC WHOLESALERS, INC.
938 Burke St./ (919) PA 5-8711
Winston-Salem, North Carolina 27101

OHIO

ESCO ELECTRONICS INC.
3130 Valleywood Drive/(513) 298-0191
Dayton, Ohio 45429
MILGRAY/CLEVELAND
1821 East 40th Street/(216) 881-8800
Cleveland, Ohio 44102
NEWARK-HERRLINGER
ELECTRONICS CORP.
112 E. Liberty St./ (513) GA 1-5282
Cincinnati, Ohio 45210
W. M. PATTISON SUPPLY CO.
4550 Willow Parkway/(216) 441-3000
Cleveland, Ohio 44125
SREPCO ELECTRONICS, INC.
314 Leo Street/(513) BA 4-3871
Dayton, Ohio 45404

OKLAHOMA

TI SUPPLY COMPANY
12151 E. Skelly Dr./ (918) 437-4555
Tulsa, Oklahoma 74110

OREGON

ALMAC STROUM ELECTRONICS
CORPORATION
8888 S.W. Canyon Road/(503) 292-3534
Portland, Oregon 97225

PENNSYLVANIA

MILGRAY/DELAWARE VALLEY INC.
2532 N. Broad St./ (215) BA 8-2000
Philadelphia, Penn. 19107
RPC ELECTRONICS
620 Alpha Dr./ (412) 782-3770
RIDC Park
Pittsburgh, Pennsylvania 15238

TEXAS

TI SUPPLY COMPANY
6000 Denton Drive/(214) FL 7-6121
Dallas, Texas 75235
5240 Elm Street/(713) MO 6-2175
Houston, Texas 77036
HARRISON EQUIPMENT COMPANY, INC.
1422 San Jacinto St./ (713) CA 4-9131
Houston, Texas 77001
MIDLAND SPECIALTY COMPANY
2235 Wyoming Ave./ (915) KE 3-9555
El Paso, Texas 79903

UTAH

STANDARD SUPPLY COMPANY
225 E. Sixth South St./ (801) EL 5-2971
Salt Lake City, Utah 84110

WASHINGTON

ALMAC-STROUM ELECTRONICS
5811 Sixth Ave. So./ (206) 763-2300
Seattle, Washington 98108

WASHINGTON, D.C.

ELECTRONIC WHOLESALERS, INC.
2345 Sherman Ave., N. W.
(202) HU 3-5200
Washington, D.C. 20001

CANADA

CANADIAN ELECTRONICS LTD.
Calgary, Alberta
Edmonton, Alberta
Lethbridge, Alberta
Medicine Hat, Alberta
Vancouver, B. C.
CESCO ELECTRONICS LTD.
Downsview, Quebec
Quebec, Quebec
Ottawa, Ontario
Toronto, Ontario
TI SUPPLY COMPANY
Dorval, Quebec
WELLINGTON, New Zealand
W. G. LEATHAM LTD.

AUSTRALIAN TI DISTRIBUTOR

MELBOURNE, Australia
RADIO PARTS PTY, LTD.
PERTH, Australia
PRECISION ELECTRONICS
BRISBANE, Australia
DOUGLAS ELECTRONICS

EUROPEAN TI DISTRIBUTORS

BRUSSELS IV, Belgium
S.A. AVI-ELEC N.V.
COPENHAGEN V, Denmark
TEXAS INSTRUMENTS A/S
HELSINKI, Finland
OY CHESTER AB
HAMBURG, West Germany
FIRMA ALFRED NEYE, ENATECHNIK

STUTTGART, WEST GERMANY

TI SUPPLY CO.
OSLO, Norway
MORGENSTIERNE & CO.

STOCKHOLM, Sweden

AB GOSTA BACKSTROM
ZURICH 32, Switzerland
FABRIMEX AG ZURICH

PARIS, FRANCE

TI SUPPLY CO.
MILANO, ITALY
TI SUPPLY CO.

MANCHESTER, ENGLAND

TI SUPPLY CO.

TYPES 2N4058, 2N4059, 2N4060, 2N4061, 2N4062 P-N-P EPITAXIAL PLANAR SILICON TRANSISTORS



TYPES 2N4058 THRU 2N4062
BULLETIN NO. DL-5 688216, APRIL 1968
REVISED MAY 1968

SILECT† TRANSISTORS

- ENCAPSULATED IN PLASTIC
- INSENSITIVE TO LIGHT
- HIGHLY MOISTURE RESISTANT

Recommended For Complementary Use With 2N3707 thru 2N3711

2N4058 For Low-Level, Low-Noise Applications
 2N4059 }
 2N4060 } For General-Purpose, Low-Level, High-Gain Applications
 2N4061 }
 2N4062 }

mechanical data

These transistors are encapsulated in a plastic compound specifically designed for this purpose, using a highly mechanized process‡ developed by Texas Instruments. The case will withstand soldering temperatures without deformation. These devices exhibit stable characteristics under high-humidity conditions and are capable of meeting MIL-STD-202C method 106B. The transistors are insensitive to light.

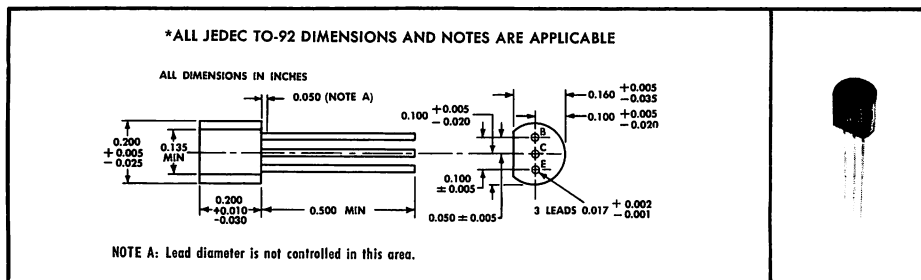

*absolute maximum ratings at 25°C free-air temperature (unless otherwise noted)

Collector-Base Voltage	- 30 V
Collector-Emitter Voltage (See Note 1)	- 30 V
Emitter-Base Voltage	- 6 V
Continuous Collector Current	- 30 mA
Continuous Device Dissipation at (or below) 25°C Free-Air Temperature (See Note 2)	360 mW
Storage Temperature Range	-65°C to 150°C
Lead Temperature 1/8 Inch from Case for 10 Seconds	260°C

NOTES: 1. This value applies when the base-emitter diode is open-circuited.
 2. Derate linearly to 150°C free-air temperature at the rate of 2.88 mW/deg.

* Indicates JEDEC registered data (typical data excluded).

†Trademark of Texas Instruments

‡Patent Pending



TEXAS INSTRUMENTS
INCORPORATED
POST OFFICE BOX 5012 • DALLAS, TEXAS 75222

TYPES 2N4058 THRU 2N4062

P-N-P EPITAXIAL PLANAR SILICON TRANSISTORS

*electrical characteristics at 25°C free-air temperature

PARAMETER	TEST CONDITIONS	2N4058	2N4059	2N4060	2N4061	2N4062	UNIT
		MIN MAX	MIN MAX	MIN MAX	MIN MAX	MIN MAX	
$V_{(BR)CEO}$ Collector-Emitter Breakdown Voltage	$I_C = -1 \text{ mA}, I_B = 0$	-30	-30	-30	-30	-30	V
I_{CBO} Collector Cutoff Current	$V_{CB} = -20 \text{ V}, I_E = 0$	-100	-100	-100	-100	-100	nA
I_{EBO} Emitter Cutoff Current	$V_{EB} = -6 \text{ V}, I_C = 0$	-100	-100	-100	-100	-100	nA
h_{FE} Static Forward Current Transfer Ratio	$V_{CE} = -5 \text{ V}, I_C = -100 \mu\text{A}$	100 400					
	$V_{CE} = -5 \text{ V}, I_C = -1 \text{ mA}$		45 660	45 165	90 330	180 660	
V_{BE} Base-Emitter Voltage	$V_{CE} = -5 \text{ V}, I_C = -1 \text{ mA}$	-0.5 -1	-0.5 -1	-0.5 -1	-0.5 -1	-0.5 -1	V
$V_{CE(sat)}$ Collector-Emitter Saturation Voltage	$I_B = -0.5 \text{ mA}, I_C = -10 \text{ mA}$	-0.7	-0.7	-0.7	-0.7	-0.7	V
h_{fe} Small-Signal Common-Emitter Forward Current Transfer Ratio	$V_{CE} = -5 \text{ V}, I_C = -100 \mu\text{A}, f = 1 \text{ kHz}$	100 550					
	$V_{CE} = -5 \text{ V}, I_C = -1 \text{ mA}, f = 1 \text{ kHz}$		45 800	45 250	90 450	180 800	

*operating characteristics at 25°C free-air temperature

PARAMETER	TEST CONDITIONS	2N4058		UNIT
		TYP	MAX	
\overline{NF} Average Noise Figure	$V_{CE} = -5 \text{ V}, I_C = -100 \mu\text{A}, R_E = 5 \text{ k}\Omega, \text{ Noise Bandwidth} = 15.7 \text{ kHz}, \text{ See Note 3}$	1.7	5	dB

NOTE 3: Average Noise Figure is measured in an amplifier with low-frequency response down 3 dB at 10 c/s.

*Indicates JEDEC registered data (typical data excluded).

THERMAL INFORMATION

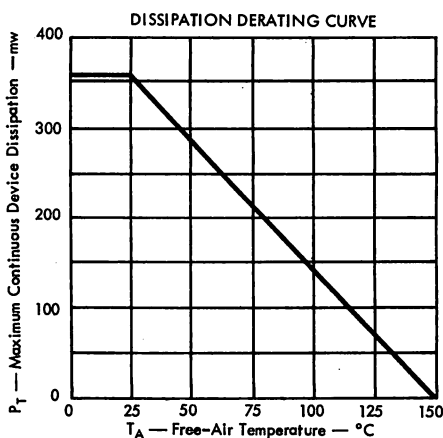

FIGURE 1

TYPE 2N4423 P-N-P EPITAXIAL PLANAR SILICON TRANSISTOR



TYPE 2N4423
BULLETIN NO. DLS-689124, AUGUST 1968
REVISED MAY 1968

SILECT† TRANSISTOR FOR HIGH-SPEED SWITCHING APPLICATIONS

- Electrically Similar to the 2N2894
- Rugged, One-Piece Construction with Standard TO-18 100-mil Pin Circle

mechanical data

This transistor is encapsulated in a plastic compound specifically designed for this purpose, using a highly mechanized process‡ developed by Texas Instruments. The case will withstand soldering temperatures without deformation. This device exhibits stable characteristics under high-humidity conditions and is capable of meeting MIL-STD-202C method 106B. The transistor is insensitive to light.

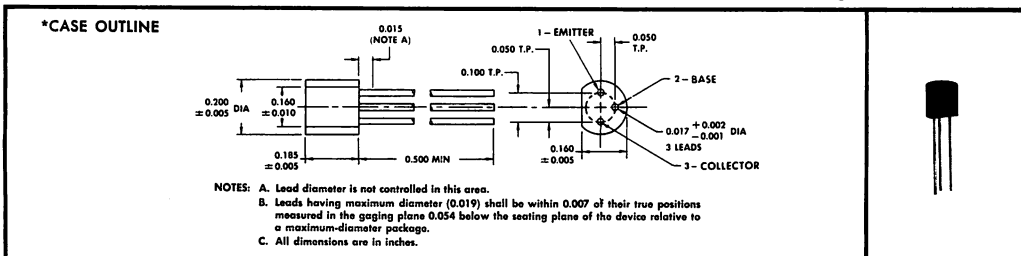

*absolute maximum ratings at 25°C free-air temperature (unless otherwise noted)

Collector-Base Voltage	-12 V
Collector-Emitter Voltage (See Note 1)	-12 V
Collector-Emitter Voltage (See Note 2)	-12 V
Emitter-Base Voltage	-4 V
Continuous Collector Current	-200 mA
Continuous Device Dissipation at (or below) 25°C Free-Air Temperature (See Note 3)	360 mW
Continuous Device Dissipation at (or below) 25°C Lead Temperature (See Note 4)	500 mW
Storage Temperature Range	-65°C to 150°C
Lead Temperature 1/16 Inch from Case for 10 Seconds	260°C

*electrical characteristics at 25°C free-air temperature (unless otherwise noted)

PARAMETER		TEST CONDITIONS		MIN	MAX	UNIT
$V_{(BR)CBO}$	Collector-Base Breakdown Voltage	$I_C = -10 \mu A, I_E = 0$		-12		V
$V_{(BR)CEO}$	Collector-Emitter Breakdown Voltage	$I_C = -10 \text{ mA}, I_B = 0,$ See Note 5		-12		V
$V_{(BR)CES}$	Collector-Emitter Breakdown Voltage	$I_C = -10 \mu A, V_{BE} = 0$		-12		V
$V_{(BR)EBO}$	Emitter-Base Breakdown Voltage	$I_E = -100 \mu A, I_C = 0$		-4		V
I_{CBO}	Collector Cutoff Current	$V_{CB} = -6 \text{ V}, I_E = 0, T_A = 70^\circ \text{C}$			-1	μA
I_{CES}	Collector Cutoff Current	$V_{CE} = -6 \text{ V}, V_{BE} = 0$			-80	nA
I_{EBO}	Emitter Cutoff Current	$V_{EB} = -3 \text{ V}, I_C = 0$			-20	nA
h_{FE}	Static Forward Current Transfer Ratio	$V_{CE} = -0.3 \text{ V}, I_C = -10 \text{ mA}$	See Note 5	30		
		$V_{CE} = -0.5 \text{ V}, I_C = -30 \text{ mA}$		40 150		
		$V_{CE} = -1 \text{ V}, I_C = -100 \text{ mA}$		20		
V_{BE}	Base-Emitter Voltage	$I_B = -1 \text{ mA}, I_C = -10 \text{ mA}$	See Note 5	-0.76	-0.98	V
		$I_B = -3 \text{ mA}, I_C = -30 \text{ mA}$		-0.82	-1.2	V
		$I_B = -10 \text{ mA}, I_C = -100 \text{ mA}$			-1.7	V
$V_{CE(sat)}$	Collector-Emitter Saturation Voltage	$I_B = -1 \text{ mA}, I_C = -10 \text{ mA}$	See Note 5	-0.15		V
		$I_B = -3 \text{ mA}, I_C = -30 \text{ mA}$		-0.2		V
		$I_B = -10 \text{ mA}, I_C = -100 \text{ mA}$		-0.5		V

- NOTES:**
- This value applies when the base-emitter diode is short-circuited.
 - This value applies between 0 and 200 mA collector current when the base-emitter diode is open-circuited. Maximum rated voltage and 200 mA collector current may be simultaneously applied provided the time of application is 10 μs or less and the duty cycle is 2% or less.
 - Derate linearly to 150°C free-air temperature at the rate of 2.88 mW/deg.
 - Derate linearly to 150°C lead temperature at the rate of 4 mW/deg. Lead temperature is measured on the collector lead 1/16 inch from the case.
 - These parameters must be measured using pulse techniques. $t_p = 300 \mu s$, duty cycle $\leq 2\%$.

*Indicates JEDEC registered data

†Trademark of Texas Instruments

‡Patent Pending



TEXAS INSTRUMENTS
INCORPORATED
POST OFFICE BOX 5012 • DALLAS, TEXAS 75222

TYPE 2N4423

P-N-P EPITAXIAL PLANAR SILICON TRANSISTOR

*electrical characteristics at 25°C free-air temperature

PARAMETER	TEST CONDITIONS	MIN	MAX	UNIT
$ h_{fe} $ Small-Signal Common-Emitter Forward Current Transfer Ratio	$V_{CE} = -5\text{ V}$, $I_C = -30\text{ mA}$, $f = 100\text{ MHz}$	4		
C_{cb} Collector-Base Capacitance	$V_{CB} = -5\text{ V}$, $I_E = 0$, $f = 1\text{ MHz}$, See Note 6	6		pF
C_{eb} Emitter-Base Capacitance	$V_{EB} = -0.5\text{ V}$, $I_C = 0$, $f = 1\text{ MHz}$, See Note 6	6		pF

NOTE 6: C_{cb} and C_{eb} are measured using three-terminal measurement techniques with the third electrode (emitter or collector respectively) guarded.

*switching characteristics at 25°C free-air temperature

PARAMETER	TEST CONDITIONS†	MAX	UNIT
t_d Delay Time	$I_C = -30\text{ mA}$, $I_{B(1)} = -3\text{ mA}$, $R_L = 93\ \Omega$, $V_{BE(off)} = 0$, See Figure 1	15	ns
t_r Rise Time		30	ns
t_{on} Turn-On Time		40	ns
t_s Storage Time	$I_C = -30\text{ mA}$, $I_{B(1)} = -3\text{ mA}$, $I_{B(2)} = 3\text{ mA}$, $R_L = 93\ \Omega$, See Figure 2	40	ns
t_f Fall Time		15	ns
t_{off} Turn-Off Time		50	ns

†Voltage and current values shown are nominal; exact values vary slightly with transistor parameters.

*PARAMETER MEASUREMENT INFORMATION

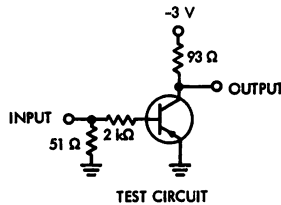

FIGURE 1

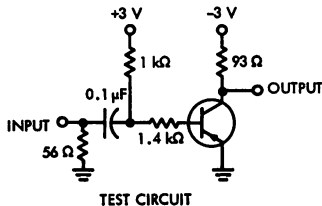
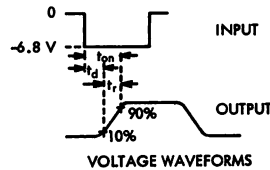
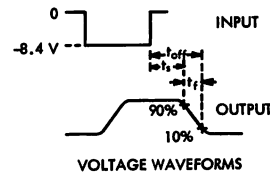

FIGURE 2



NOTES: a. The input waveforms are supplied by a generator with the following characteristics: $Z_{out} = 50\ \Omega$, $t_r \leq 1\text{ ns}$, $t_p \geq 200\text{ ns}$, duty cycle $\leq 2\%$.

b. Waveforms are monitored on an oscilloscope with the following characteristics: $t_r \leq 1\text{ ns}$, $R_{in} \geq 100\text{ k}\Omega$, $C_{in} \leq 10\text{ pF}$.

*Indicates JEDEC registered date.

TYPES 2N5447, 2N5448 P-N-P EPITAXIAL PLANAR SILICON TRANSISTORS



TYPES 2N5447, 2N5448
BULLETIN NO. DL-5-6810923 MAY 1968

SILECT† TRANSISTORS

Encapsulated in Plastic for Such Applications as
Medium-Power Amplifiers, Class B Audio Outputs, and Hi-Fi Drivers

- Electrically Equivalent to 2N3702 and 2N3703
- For Complementary Use with 2N5449, 2N5450, and 2N5451
- Rugged, One-Piece Construction Features Standard 100-mil TO-18 Pin Circle

mechanical data

These transistors are encapsulated in a plastic compound specifically designed for this purpose, using a highly mechanized process‡ developed by Texas Instruments. The case will withstand soldering temperatures without deformation. These devices exhibit stable characteristics under high-humidity conditions and are capable of meeting MIL-STD-202C method 106B. The transistors are insensitive to light.

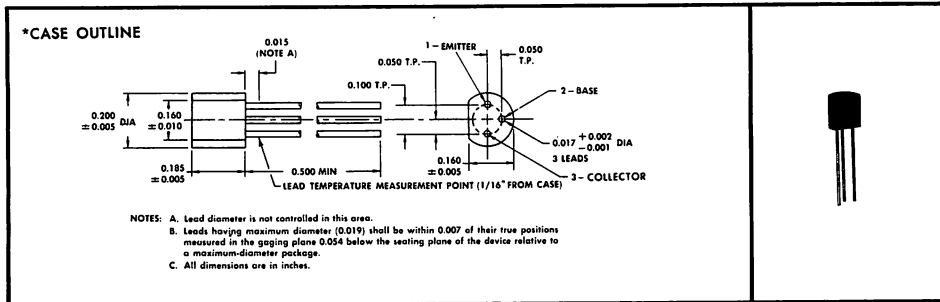

*absolute maximum ratings at 25°C free-air temperature (unless otherwise noted)

	2N5447	2N5448
Collector-Base Voltage	-40 V	-50 V
Collector-Emitter Voltage (See Note 1)	-25 V	-30 V
Emitter-Base Voltage	-5 V	-5 V
Continuous Collector Current	← -200 mA →	
Continuous Device Dissipation at (or below) 25°C Free-Air Temperature (See Note 2)	← 360 mW →	
Continuous Device Dissipation at (or below) 25°C Lead Temperature (See Note 3)	← 500 mW →	
Storage Temperature Range	-65°C to 150°C	
Lead Temperature 1/16 Inch from Case for 10 Seconds	← 260°C →	

- NOTES: 1. These values apply when the base-emitter diode is open-circuited.
2. Derate linearly to 150°C free-air temperature at the rate of 2.88 mW/deg.
3. Derate linearly to 150°C lead temperature at the rate of 4 mW/deg. Lead temperature is measured on the collector lead 1/16 inch from the case.

*Indicates JEDEC registered data
†Trademark of Texas Instruments
‡Patent pending

TYPES 2N5447, 2N5448

P-N-P EPITAXIAL PLANAR SILICON TRANSISTORS

*electrical characteristics at 25°C free-air temperature

PARAMETER	TEST CONDITIONS	2N5447		2N5448		UNIT
		MIN	MAX	MIN	MAX	
$V_{(BR)CBO}$ Collector-Base Breakdown Voltage	$I_C = -100 \mu A, I_E = 0$	-40		-50		V
$V_{(BR)CEO}$ Collector-Emitter Breakdown Voltage	$I_C = -10 \text{ mA}, I_B = 0$, See Note 4	-25		-30		V
$V_{(BR)EBO}$ Emitter-Base Breakdown Voltage	$I_E = -100 \mu A, I_C = 0$	-5		-5		V
I_{CBO} Collector Cutoff Current	$V_{CB} = -20 \text{ V}, I_E = 0$		-100		-100	nA
I_{EBO} Emitter Cutoff Current	$V_{EB} = -3 \text{ V}, I_C = 0$		-100		-100	nA
h_{FE} Static Forward Current Transfer Ratio	$V_{CE} = -5 \text{ V}, I_C = -50 \text{ mA}$, See Note 4	60	300	30	150	
V_{BE} Base-Emitter Voltage	$V_{CE} = -5 \text{ V}, I_C = -50 \text{ mA}$, See Note 4	-0.6	-1	-0.6	-1	V
$V_{CE(sat)}$ Collector-Emitter Saturation Voltage	$I_B = -5 \text{ mA}, I_C = -50 \text{ mA}$, See Note 4		-0.25		-0.25	V
$ h_{fe} $ Small-Signal Common-Emitter Forward Current Transfer Ratio	$V_{CE} = -5 \text{ V}, I_C = -50 \text{ mA}, f = 20 \text{ MHz}$		5		5	
C_{cb} Collector-Base Capacitance	$V_{CB} = -10 \text{ V}, I_E = 0, f = 1 \text{ MHz}$, See Note 5		12		12	pF

NOTES: 4. These parameters must be measured using pulse techniques. $t_p = 300 \mu s$, duty cycle $\leq 2\%$.
 5. C_{cb} is measured using three-terminal measurement techniques with the emitter guarded.

*Indicates JEDEC registered data

THERMAL INFORMATION

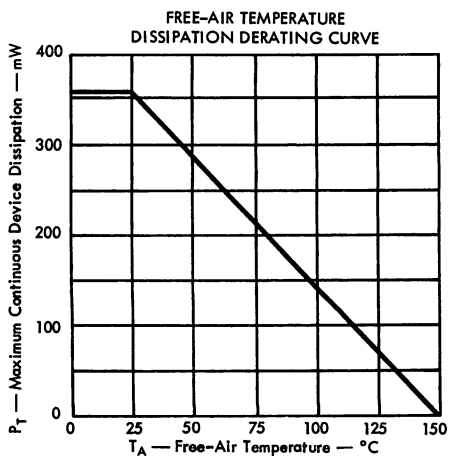

FIGURE 1

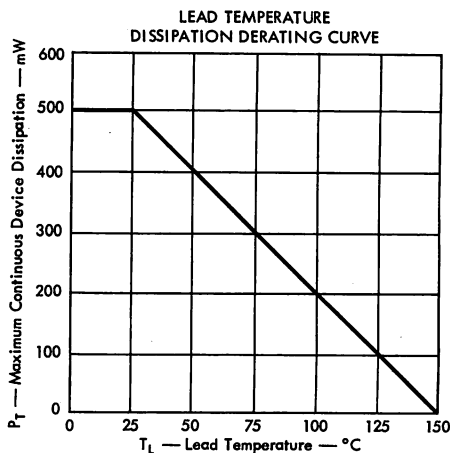
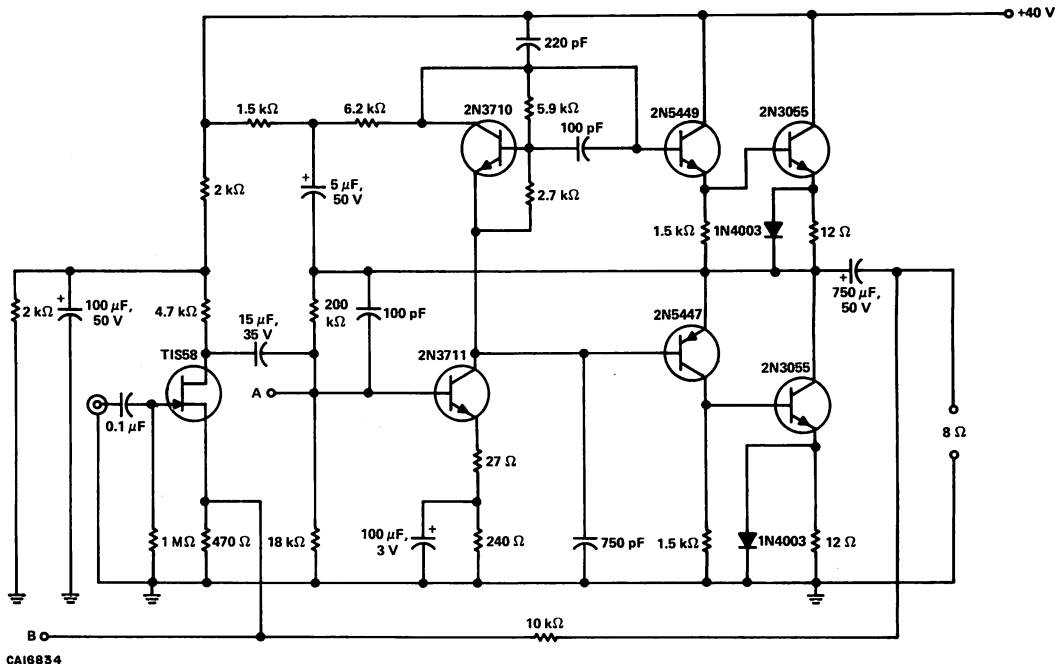

FIGURE 2

TYPES 2N5447, 2N5448 P-N-P EPITAXIAL PLANAR SILICON TRANSISTORS

TYPICAL APPLICATION DATA

SILICON 15-WATT QUASI-COMPLEMENTARY POWER AMPLIFIER



TYPICAL PERFORMANCE SPECIFICATIONS

Continuous Output Power	15 W @ 0.15% THD
Power Bandwidth @ 7.5 W	20 Hz – 20 kHz
Frequency Response ± 0.5 dB	10 Hz – 50 kHz
Total Harmonic Distortion @ 7.5 W	0.06%
Intermodulation Distortion @ 7.5 W	0.15%
Sensitivity @ 15 W	850 mV
Input Impedance	1 M Ω
Hum and Noise: "C" Weighting	
Input Shorted	-95 dB
Input Open	-85 dB
Damping Factor	48

TI World-Wide Sales Offices

ALABAMA

Sahara Office Park Bldg., Suite 111
3313 Memorial Parkway, S.W.
Huntsville, Alabama 35801
205-881-4061

ARIZONA

2535 W. Camelback Rd., Suite 1D
Phoenix, Arizona 85017
602-279-5531

CALIFORNIA

1800 North Argyle Ave.
Hollywood, California 90028
213-466-7251

5005 West Century Blvd., Suite 208
Inglewood, California 90301
213-673-3943

230 California Ave., Suite 201
Palo Alto, California 94306
415-326-6770

1505 East 17th St., Suite 201
Santa Ana, California 92701
714-547-6506

4185 Adams Ave.
San Diego, California 92116
714-284-1181

COLORADO

2186 South Holly St., Suite 204
Denver, Colorado 80222
303-757-8548

CONNECTICUT

300 Amity Road
Woodbridge, Connecticut 06525
203-389-4521

FLORIDA

618 East South St., Suite 114
Orlando, Florida 32801
305-422-9894

ILLINOIS

Suite 205, Executive Towers
5901 N. Cicero Ave.
Chicago, Illinois 60646
312-286-1000

MASSACHUSETTS

60 Hickory Drive
Waltham, Mass. 02154
617-891-8450

MICHIGAN

Suite 706 West, Northland Towers Bldg.
15565 Northland Dr.
Southfield, Michigan 48075
313-357-1703

MINNESOTA

7615 Metro Blvd.
Suite 202, U.C.L.I. Bldg.
Edina, Minn. 55424
612-941-4384

NEW JERSEY

U.S. Highway #22
P.O. Box 366
Union, New Jersey 07083
201-687-7200

NEW YORK

P. O. Box 87, 2209 E. Main
Endicott, New York 13760
607-785-9987

4 Nevada Drive
New Hyde Park, N. Y. 11040
516-488-9894

131 Fulton Ave., Apt. J-2
Poughkeepsie, New York 12603
914-471-6095

6563 Ridings Rd.
Syracuse, New York 13206
315-463-9291

OHIO

22035 Chagrin Blvd.
Cleveland, Ohio 44122
216-751-2600

Suite 205, Paul Welch Bldg.
3300 South Dixie Dr.
Dayton, Ohio 45439
513-298-7513

PENNSYLVANIA

Benjamin Fox Pavilion
Suite 424, Foxcroft Square
Jenkintown, Pa. 19046
215-885-3454

TEXAS

MS80 — P.O. Box 5012
Dallas, Texas 75222
214-238-4861

3609 Buffalo Speedway
Houston, Texas 77006
713-526-3268

WASHINGTON

5801 Sixth Ave. S.
Seattle, Washington 98108
206-762-4240

WASHINGTON, D.C.

1875 Connecticut Ave., N.W., Suite 913
Washington, D.C. 20009
202-234-9320

CANADA

Geophysical Service Incorporated
280 Centre Str. East
Richmond Hills
Ontario, Canada
925-1035

663 Orly Avenue
Dorval
Quebec, Canada
631-6010

EUROPE

Texas Instruments Limited
Manton Lane
Bedford, England

Texas Instruments France S. A.
Boîte Postale 5
Villeneuve-Loubet (A.M.), France

11 rue de Madrid
Paris 8°, France

Texas Instruments Holland N.V.
Semiconductor Division
Enschedesestraat 19
Hengelo (Ov), Holland

Texas Instruments Italia S.p.A.
Via Colautti 1
Milan, Italy

Texas Instruments Incorporated
118 Rue du Rhone
1204 Geneva, Switzerland

Texas Instruments Sweden A.B.
Timmermangatan 34, Box 17116
Stockholm 17, Sweden

Texas Instruments Deutschland GmbH
Hildesheimerstr. 19
3 Hannover, W. Germany

Texas Instruments Deutschland GmbH
Wolframstrasse 26
7 Stuttgart
West Germany

Texas Instruments Deutschland GmbH
Clemensstrasse 30
8 Munich 23
West Germany

Texas Instruments Deutschland GmbH
Kepserstrasse 33
805 Freising-Lerchenfeld
West Germany

Texas Instruments Deutschland GmbH
Koenigsbacherstrasse 22
6 Frankfurt, West Germany

MEXICO

Texas Instruments de Mexico S.A.
Poniente 116 #489
Col. Ind. Vallejo
Mexico 15, D.F.

ARGENTINA

Texas Instruments Argentina S.A.I.C.F.
(P. O. Box 2296 — Correo Central)
Ruta Panamericana Km. 13, 5
Don Torcuato
Buenos Aires, Argentina

BRAZIL

Texas Instrumentos Electronicos
do Brazil Ltda.
Rua Cesario Alvim 770
Caixa Postal 30.103
Sao Paulo 6, Brazil

AUSTRALIA

Texas Instruments Australia Ltd.
Box 63, Oldham Road
Elizabeth, South Australia

Texas Instruments Australia Ltd.
Room 5, Rural Bank Bldg.
Burwood, N.S.W., Australia

JAPAN

Texas Instruments Asia Limited
404 T.B.R. Building
No. 59, 2-chome, Nagata-cho
Chiyoda-du, Tokyo, Japan

TYPE 2N918 N-P-N EPITAXIAL PLANAR SILICON TRANSISTOR



TYPE 2N918
BULLETIN NO. DL-S-643996, AUGUST 1964
REVISED OCTOBER 1966

DESIGNED FOR USE IN VHF AND UHF AMPLIFIER AND OSCILLATOR APPLICATIONS TO THE KILOMEGACYCLE REGION

- Low Noise Figure — 3 db typ at 60 mc
- High Neutralized Power Gain — 18 db typ at 200 mc
- High Oscillator Power Output — 50 mw typ at 500 mc
- Low Collector-Base Time Constant — 8 psec typ

*mechanical data

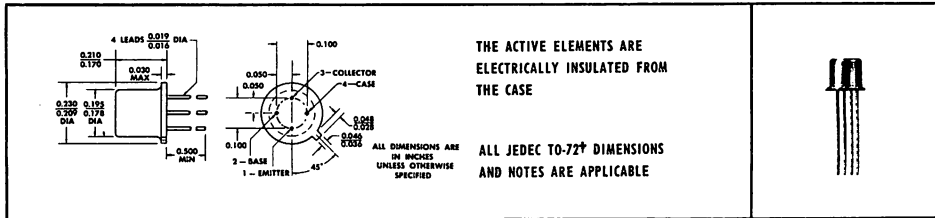

†TO-72 outline is same as TO-18 outline with the addition of a fourth lead.

*absolute maximum ratings at 25°C free-air temperature (unless otherwise noted)

Collector-Base Voltage	30 v
Collector-Emitter Voltage (See Note 1)	15 v
Emitter-Base Voltage	3 v
Collector Current	50 ma
Total Device Dissipation at (or below) 25°C Free-Air Temperature (See Note 2)	200 mw
Total Device Dissipation at (or below) 25°C Case Temperature (See Note 3)	300 mw
Operating Collector Junction Temperature	200°C
Storage Temperature Range	-65°C to +200°C

*electrical characteristics at 25°C free-air temperature (unless otherwise noted)

PARAMETER	TEST CONDITIONS†	MIN	TYP	MAX	UNIT
BV_{CBO} Collector-Base Breakdown Voltage	$I_C = 1 \mu a, I_E = 0$	30			v
BV_{CEO} Collector-Emitter Breakdown Voltage	$I_C = 3 ma, I_B = 0$	15			v
BV_{EBO} Emitter-Base Breakdown Voltage	$I_E = 10 \mu a, I_C = 0$	3			v
I_{CBO} Collector Cutoff Current	$V_{CB} = 15 v, I_E = 0$			10	na
	$V_{CB} = 15 v, I_E = 0, T_A = 150^\circ C$			1	μa
h_{FE} Static Forward Current Transfer Ratio	$V_{CE} = 1 v, I_C = 3 ma$		20		
V_{BE} Base-Emitter Voltage	$I_B = 1 ma, I_C = 10 ma$			1.0	v
$V_{CE(sat)}$ Collector-Emitter Saturation Voltage	$I_B = 1 ma, I_C = 10 ma$			0.4	v
$ h_{fe} $ Small-Signal Common-Emitter Forward Current Transfer Ratio	$V_{CE} = 10 v, I_C = 4 ma, f = 100 mc$	6.0	9.0		
C_{ob} Common-Base Open-Circuit Output Capacitance	$V_{CB} = 10 v, I_E = 0, f = 140 kc$			1.7	pf
	$V_{CB} = 0, I_E = 0, f = 140 kc$			3.0	pf
C_{ib} Common-Base Open-Circuit Input Capacitance	$V_{EB} = 0.5 v, I_C = 0, f = 140 kc$			2.0	pf
$r_b' C_c$ Collector-Base Time Constant	$V_{CB} = 10 v, I_E = -4 ma, f = 79.8 mc$		8		psec

- NOTES: 1. This value applies when the base-emitter diode is open-circuited.
 2. Derate linearly to 200°C free-air temperature at the rate of 1.14 mw/°C.
 3. Derate linearly to 200°C case temperature at the rate of 1.71 mw/°C.

†The fourth lead (case) is floating for all measurements except Power Gain. For this parameter the fourth lead is grounded.

*Indicates JEDEC registered data (typical data excluded).

TYPE 2N918

N-P-N EPITAXIAL PLANAR SILICON TRANSISTOR

*operating characteristics at 25°C free-air temperature

PARAMETER		TEST CONDITIONS†	MIN	TYP	MAX	UNIT
NF	Spot Noise Figure	$V_{CE} = 6 \text{ v}$, $I_C = 1 \text{ ma}$, $R_E = 400 \Omega$ $f = 60 \text{ mc}$		3	6	db
G_{P_o}	Neutralized Small-Signal Common-Emitter Insertion Power Gain	$V_{CB} = 12 \text{ v}$, $I_C = 6 \text{ ma}$, $f = 200 \text{ mc}$ (See Figure 1)	15	18		db
P_o	Oscillator Power Output	$V_{CB} = 15 \text{ v}$, $I_C = 8 \text{ ma}$, $f = 500 \text{ mc}$	30	50		mw
η	Collector Efficiency	(See Figure 2)	25%	42%		

†The fourth lead (case) is floating for all measurements except Power Gain. For this parameter the fourth lead is grounded.

PARAMETER MEASUREMENT INFORMATION

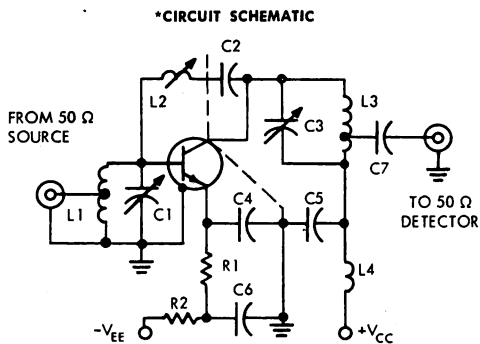

FIGURE 1 — NEUTRALIZED 200 mc INSERTION POWER GAIN

NEUTRALIZATION ADJUSTMENT PROCEDURE

After tuning amplifier as for normal gain measurement, reverse input and output connections and tune L2 for minimum indication on detector. This sequence is repeated until optimum settings are obtained for all variables.

* CIRCUIT COMPONENT INFORMATION

- C1: 3 — 12 pf
- C2 and C7: 1000 pf
- C3: 1.5 — 7.5 pf
- C4 and C5: 0.01 μf
- C6: 0.05 μf
- R1: 100 Ω
- R2: 1 k Ω
- L1: 3½ T #16 AWG, ⅜" ID, ⅝" length
Turns Ratio \approx 2 to 1
- L2: 0.4 — 0.65 μH , Miller #4303 (or equivalent).
- L3: 8 T #16 AWG, ⅜" ID, ⅝" length,
Turns Ratio \approx 8 to 1
- L4: 200 mc RFC

CIRCUIT SCHEMATIC

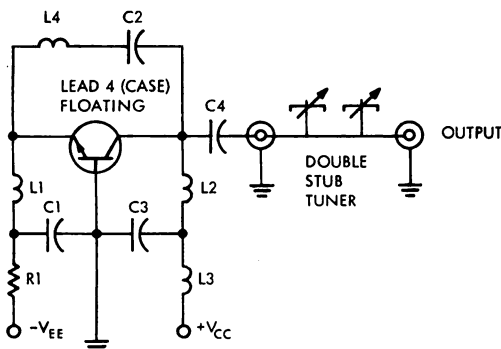

CIRCUIT COMPONENT INFORMATION

- C1 and C3: 1000 pf
 - C2: 50 pf
 - C4: 75 pf
 - R1: 2.2 k Ω
 - L1, L3, and L4: 0.2 μH , Ohmite Z460 (or equivalent).
 - L2: 2 T #16 AWG, ⅜" OD, 1¼" length
- Double Stub Tuner consists of the following plumbing (or equivalent):
- 2 GR Type 874 TEE
 - 1 GR Type 874-D20 Adjustable Stub
 - 1 GR Type 874-LA Adjustable Line
 - 1 GR Type 874-WN3 Short-Circuit Termination

* FIGURE 2 — 500 mc OSCILLATOR POWER OUTPUT

*Indicates JEDEC registered data (typical data excluded).

TYPES 2N3570, 2N3571, 2N3572 N-P-N EPITAXIAL PLANAR SILICON TRANSISTORS



FOR APPLICATIONS REQUIRING LOW NOISE FIGURE AND SUPERIOR
SMALL-SIGNAL PERFORMANCE FROM VHF TO 1.5 GIGACYCLES

2N3570 (Formerly TIX3015) Features:

- Guaranteed Noise Figure — 7.0 db max at 1 Gc
- Guaranteed Gain-Bandwidth Product — 1.5 Gc
- Guaranteed $r_b'c_c$ — 8 psec max

description

These transistors are ideally suited for such applications as amplifiers, oscillators, and mixers. The guaranteed minimum gain-bandwidth products range from 1 to 1.5 Gc. Guaranteed minimum calculated f_{max} ranges from 1.7 to 2.7 Gc. These features coupled with low noise figures insure VHF through L-band amplifier and oscillator capability.

*mechanical data

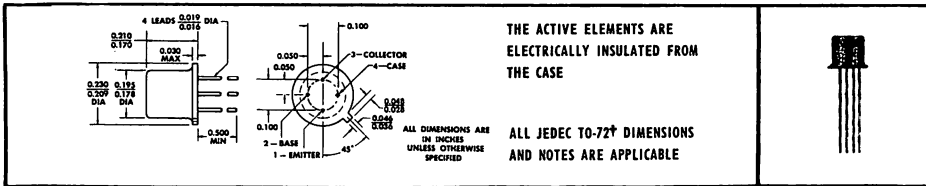

†TO-72 outline is same as TO-18 outline with the addition of a fourth lead.

*absolute maximum ratings at 25°C free-air temperature (unless otherwise noted)

	2N3570	2N3571	2N3572
Collector-Base Voltage	30 v	25 v	25 v
Collector-Emitter Voltage (See Note 1)	15 v	15 v	13 v
Emitter-Base Voltage	3 v	3 v	3 v
Collector Current	← 50 ma →		
Continuous Device Dissipation at (or below) 25°C Free-Air Temperature (See Note 2)	← 200 mw →		
Continuous Device Dissipation at (or below) 25°C Case Temperature (See Note 3)	← 350 mw →		
Storage Temperature Range	← -65°C to +200°C →		
Lead Temperature 1/8 Inch from Case for 10 Seconds	← 300°C →		

*electrical characteristics at 25°C free-air temperature (unless otherwise noted)

PARAMETER	TEST CONDITIONS†	2N3570			2N3571		2N3572		UNIT
		MIN	TYP	MAX	MIN	MAX	MIN	MAX	
BV_{CBO} Collector-Base Breakdown Voltage	$I_C = 1 \mu A, I_E = 0$	30			25		25		v
BV_{CEO} Collector-Emitter Breakdown Voltage	$I_C = 2 \text{ ma}, I_B = 0, \text{ See Note 4}$	15			15		13		v
BV_{EBO} Emitter-Base Breakdown Voltage	$I_E = 10 \mu A, I_C = 0$	3			3		3		v
I_{CBO} Collector Cutoff Current	$V_{CB} = 6 \text{ v}, I_E = 0$			10			10		na
	$V_{CB} = 6 \text{ v}, I_E = 0, T_A = 150^\circ C$			1			1		μA
h_{FE} Static Forward Current Transfer Ratio	$V_{CE} = 6 \text{ v}, I_C = 5 \text{ ma}$	20		150	20	200	20	300	
h_{fo} Small-Signal Common-Emitter Forward Current Transfer Ratio	$V_{CE} = 6 \text{ v}, I_C = 5 \text{ ma}, f = 1 \text{ kc}$	20		200	20	250	20	350	
$ h_{fo} $ Small-Signal Common-Emitter Forward Current Transfer Ratio	$V_{CE} = 6 \text{ v}, I_C = 5 \text{ ma}, f = 400 \text{ Mc}$	3.75	4.25	6	3	6	2.5	6	
C_{cb} Collector-Base Capacitance	$V_{CB} = 6 \text{ v}, I_E = 0, f = 1 \text{ Mc}, \text{ See Note 5}$		0.60	0.75		0.85		0.85	pf
$r_b'c_c$ Collector-Base Time Constant	$V_{CB} = 6 \text{ v}, I_E = -5 \text{ ma}, f = 79.8 \text{ Mc}$	1	5	8	1	10	1	13	psec

- NOTES: 1. This value applies between 0 and 15 ma collector current when the base-emitter diode is open-circuited.
2. Derate linearly to 200°C free-air temperature at the rate of 1.14 mw/°C.
3. Derate linearly to 200°C case temperature at the rate of 2 mw/°C.
4. This parameter must be measured using pulse techniques. PW = 300 μ sec, Duty Cycle \leq 2%.
5. C_{cb} is measured using three-terminal measurement techniques with case and emitter guarded.

†The fourth lead (case) is grounded for all measurements except C_{cb} and Oscillator Power Output.

*Indicates JEDEC registered data (typical data excluded).



TEXAS INSTRUMENTS
INCORPORATED
POST OFFICE BOX 5012 • DALLAS, TEXAS 75222

TYPES 2N3570, 2N3571, 2N3572

N-P-N EPITAXIAL PLANAR SILICON TRANSISTORS

*operating characteristics at 25°C free-air temperature

PARAMETER	TEST CONDITIONS†	2N3570		2N3571		2N3572		UNIT
		TYP	MAX	TYP	MAX	TYP	MAX	
NF Spot Noise Figure	$V_{CB} = 6\text{ v}$, $I_E = -2\text{ ma}$, $R_G = 50\ \Omega$, $f = 1\text{ Gc}$, See Note 6	6	7					db
	$V_{CB} = 6\text{ v}$, $I_E = -2\text{ ma}$, $R_G = 100\ \Omega$, $f = 450\text{ Mc}$				4		6	db

†The fourth lead (case) is grounded for all measurements except C_{cb} and Oscillator Power Output.

operating characteristics at 25°C case temperature

PARAMETER	TEST CONDITIONS	2N3570			UNIT
		MIN	TYP	MAX	
P_o Oscillator Power Output	$V_{CC} = 20\text{ v}$, $I_C = 15\text{ ma}$, $f = 1\text{ Gc}$, See Figure 1 and Note 7		60		mw

TYPICAL CHARACTERISTICS AT $T_A = 25^\circ\text{C}$

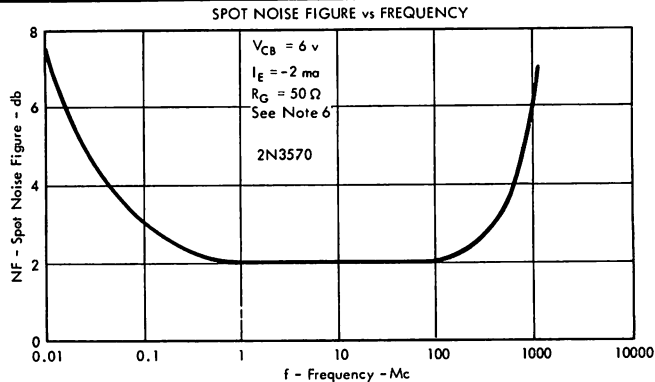

NOTE 6: For detailed information on measurement technique, write for "Transistor Noise Figure Measurement at 1 Gc", referring to publication SC-4461.

PARAMETER MEASUREMENT INFORMATION

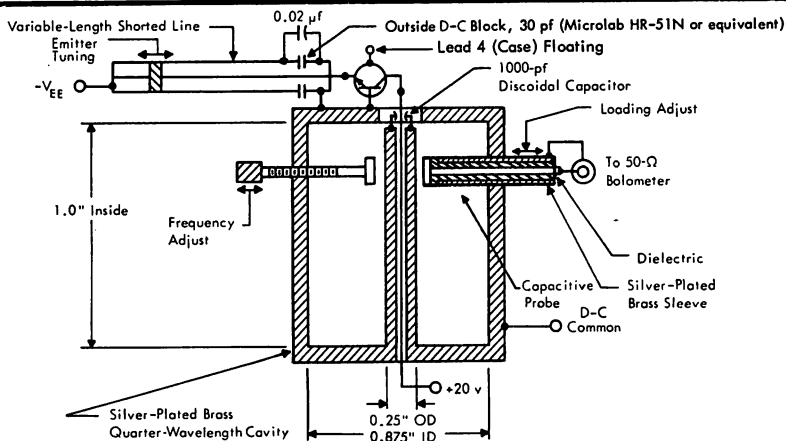

NOTE 7: For detailed information on measurement technique, write for "Transistor Oscillator Power Output Measurement at 1 Gc", referring to publication SC-4730.
 *Indicates JEDEC registered data.



- Ideal Broadband Amplifier for CATV Line Amplifiers (50 MHz to 250 MHz)
- High Power Gain... 10 dB Min at 400 MHz
- High Collector Efficiency... 45% Min
- High f_T ... 500 MHz Min
- High $V_{(BR)CEO}$... 30 V Min
- Applications in Military, Commercial, and Citizens Band Radio Equipment

*mechanical data

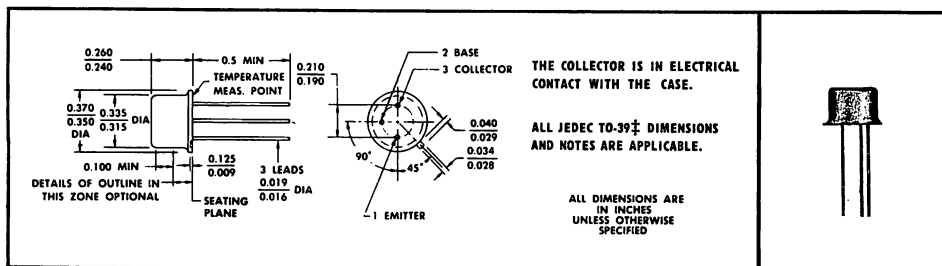

‡T0-39 is similar to T0-5 except for minimum lead length.

*absolute maximum ratings at 25°C case temperature (unless otherwise noted)

Collector-Base Voltage	55 V
Collector-Emitter Voltage (See Note 1)	30 V
Emitter-Base Voltage	3.5 V
Continuous Collector Current	400 mA
Continuous Base Current	400 mA
Continuous Device Dissipation at (or below) 25°C Case Temperature (See Note 2)	5 W
Storage Temperature Range	-65°C to 200°C
Lead Temperature 1/16 Inch from Case for 10 Seconds	230°C

NOTES: 1. This value applies when the base-emitter diode is open-circuited.
2. Derate linearly to 200°C case temperature at the rate of 28.6 mW/deg.

*Indicates JEDEC registered data



TYPE 2N3866

N-P-N EPITAXIAL PLANAR SILICON TRANSISTOR

*electrical characteristics at 25°C case temperature (unless otherwise noted)

PARAMETER	TEST CONDITIONS	MIN	TYP	MAX	UNIT
$V_{(BR)CEO}$ Collector-Emitter Breakdown Voltage	$I_C = 5 \text{ mA}$, $I_B = 0$, See Note 3	30			V
$V_{(BR)CER}$ Collector-Emitter Breakdown Voltage	$I_C = 5 \text{ mA}$, $R_{BE} = 10 \Omega$, See Note 3	55			V
I_{CEV} Collector Cutoff Current	$V_{CE} = 55 \text{ V}$, $V_{BE} = -1.5 \text{ V}$			0.1	mA
	$V_{CE} = 30 \text{ V}$, $V_{BE} = -1.5 \text{ V}$, $T_C = 200^\circ\text{C}$			5	mA
I_{CEO} Collector Cutoff Current	$V_{CE} = 28 \text{ V}$, $I_B = 0$			20	μA
I_{EBO} Emitter Cutoff Current	$V_{EB} = 3.5 \text{ V}$, $I_C = 0$			0.1	mA
h_{FE} Static Forward Current Transfer Ratio	$V_{CE} = 5 \text{ V}$, $I_C = 360 \text{ mA}$, See Note 3	5			
	$V_{CE} = 5 \text{ V}$, $I_C = 50 \text{ mA}$, See Note 3	10	35	200	
$V_{CE(sat)}$ Collector-Emitter Saturation Voltage	$I_B = 20 \text{ mA}$, $I_C = 100 \text{ mA}$, See Note 3			1	V
$ h_{fo} $ Small-Signal Common-Emitter Forward Current Transfer Ratio	$V_{CE} = 15 \text{ V}$, $I_C = 50 \text{ mA}$, $f = 200 \text{ MHz}$	2.5			
C_{abo} Common-Base Open-Circuit Output Capacitance	$V_{CB} = 28 \text{ V}$, $I_E = 0$, $f = 1 \text{ MHz}$			3	pF

NOTE 3: These parameters must be measured using pulse techniques. $t_p = 300 \mu\text{s}$, duty cycle $\leq 2\%$.

*operating characteristics at 25°C case temperature

PARAMETER	TEST CONDITIONS	MIN	MAX	UNIT
P_{IE} Large-Signal Common-Emitter Input Power	$P_{OE} = 1 \text{ W}$, $f = 400 \text{ MHz}$,		0.1	W
η Collector Efficiency	See Figure 1	45%		

*Indicates JEDEC registered data

PARAMETER MEASUREMENT INFORMATION

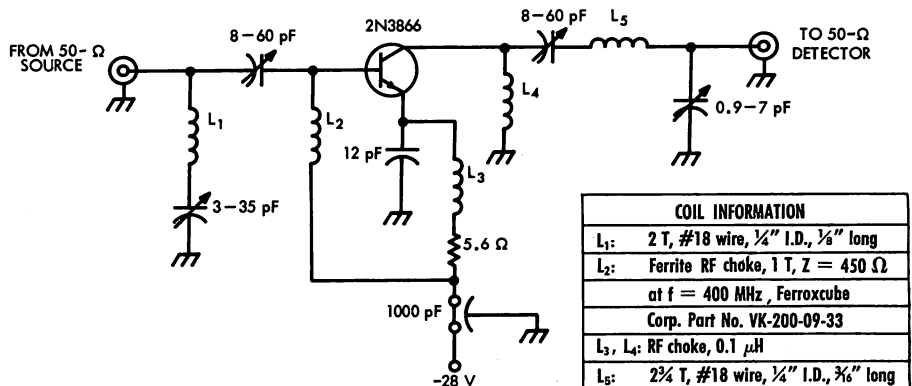

FIGURE 1 — 400-MHz INPUT POWER AND COLLECTOR EFFICIENCY TEST CIRCUIT

TYPES 2N4874, 2N4875, 2N4876 N-P-N EPITAXIAL PLANAR SILICON TRANSISTORS



TYPES 2N4874 THRU 2N4876
BULLETIN NO. DL-5 679722, JANUARY 1967

DESIGNED FOR VHF THRU MICROWAVE APPLICATIONS

- Ideal Broad-Band Amplifiers for CATV Line Amplifiers (50 MHz to 250 MHz)
 - Linear Amplifiers for Single-Sideband Applications
- Calculated $f_{max}^{\dagger} \dots 1.9 \text{ GHz Min (2N4874)}$

* mechanical data

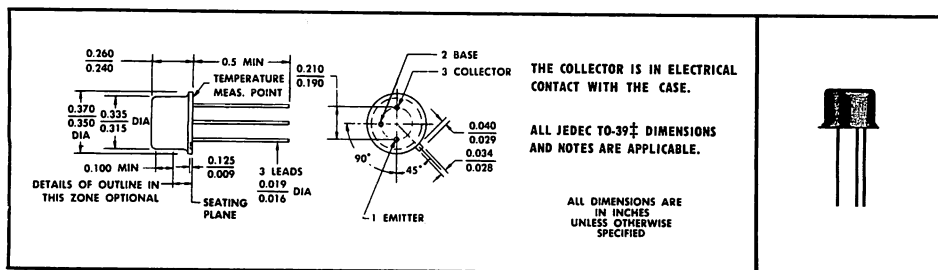

‡T0-39 is similar to T0-5 except for minimum lead length.

* absolute maximum ratings at 25°C free-air temperature (unless otherwise noted)

	2N4874	2N4875	2N4876
Collector-Base Voltage	30 V	40 V	40 V
Collector-Emitter Voltage (See Note 1)	20 V	25 V	30 V
Emitter-Base Voltage	2 V	2 V	2 V
Continuous Collector Current	← 200 mA →		
Continuous Device Dissipation at (or below) 25°C Free-Air Temperature (See Note 2)	← 720 mW →		
Continuous Device Dissipation at (or below) 25°C Case Temperature (See Note 3)	← 6 W →		
Storage Temperature Range	← -65°C to 200°C →		
Lead Temperature $\frac{1}{16}$ Inch from Case for 10 Seconds	← 300°C →		

NOTES: 1. This value applies between 0 and 100 mA collector current when the base-emitter diode is open-circuited.

2. Derate linearly to 175°C free-air temperature at the rate of 4.8 mW/deg.

3. Derate linearly to 175°C case temperature at the rate of 40 mW/deg.

*Indicates JEDEC registered data.

†Maximum Frequency of Oscillation may be calculated from the equation: $f_{max} \text{ (MHz)} = 200 \sqrt{\frac{|h_{fo}| \times f_{mos} \text{ (MHz)}}{I_b' C_c \text{ (ps)}}$



TEXAS INSTRUMENTS
INCORPORATED
POST OFFICE BOX 9012 • DALLAS, TEXAS 75222

TYPES 2N4874 THRU 2N4876

N-P-N EPITAXIAL PLANAR SILICON TRANSISTORS

*electrical characteristics at 25°C free-air temperature (unless otherwise noted)

PARAMETER	TEST CONDITIONS	2N4874	2N4875	2N4876	UNIT	
		MIN	MAX	MIN		MAX
$V_{(BR)CBO}$ Collector-Base Breakdown Voltage	$I_C = 100 \mu A, I_E = 0$	30	40	40	V	
$V_{(BR)CEO}$ Collector-Emitter Breakdown Voltage	$I_C = 10 \text{ mA}, I_B = 0, \text{ See Note 4}$	20	25	30	V	
I_{CBO} Collector Cutoff Current	$V_{CB} = 15 \text{ V}, I_E = 0$	0.5	0.5	0.5	μA	
	$V_{CB} = 15 \text{ V}, I_E = 0, T_A = 150^\circ C$	0.5	0.5	0.5	mA	
I_{EBO} Emitter Cutoff Current	$V_{EB} = 2 \text{ V}, I_C = 0$	10	10	10	μA	
h_{fe} Small-Signal Common-Emitter Forward Current Transfer Ratio	$V_{CE} = 10 \text{ V}, I_C = 50 \text{ mA}, f = 1 \text{ kHz}$	20	200	20	200	
$ h_{fe} $ Small-Signal Common-Emitter Forward Current Transfer Ratio	$V_{CE} = 10 \text{ V}, I_C = 20 \text{ mA}, f = 100 \text{ MHz}$	7	24	6	24	
	$V_{CE} = 10 \text{ V}, I_C = 50 \text{ mA}, f = 100 \text{ MHz}$	9	25	8	25	6.5
C_{cb} Collector-Base Capacitance	$V_{CB} = 10 \text{ V}, I_E = 0, f = 1 \text{ MHz}, \text{ See Note 5}$	3.5	3.5	3.5	pF	
$r_b'c$ Collector-Base Time Constant	$V_{CB} = 10 \text{ V}, I_E = -50 \text{ mA}, f = 79.8 \text{ MHz}$	10	10	10	ps	

NOTES: 4. These parameters must be measured using pulse techniques. $I_p = 300 \mu s$, duty cycle $\leq 2\%$.

5. Collector-Base Capacitance is measured using three-terminal measurement techniques with the emitter guarded.

*operating characteristics at 25°C free-air temperature

PARAMETER	TEST CONDITIONS	2N4874	2N4875	2N4876	UNIT
		MIN	MIN	MIN	
G_{PE} Large-Signal Common-Emitter Insertion Power Gain	$V_{BB} = 20 \text{ V}, I_E = -100 \text{ mA}, P_{IE} = 0.1 \text{ W}, f = 400 \text{ MHz}, \text{ See Figure 1}$	10	9.5	8.5	dB

*PARAMETER MEASUREMENT INFORMATION

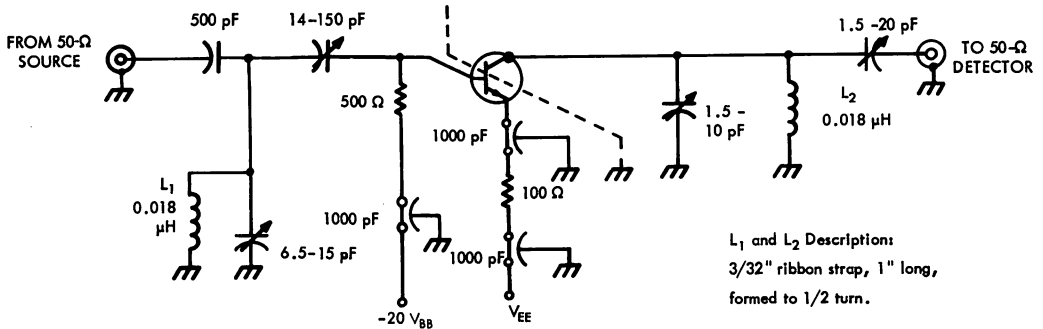

*Indicates JEDEC registered data

FIGURE 1 — 400-MHz INSERTION-POWER-GAIN TEST CIRCUIT

TYPES 2N4874 THRU 2N4876 N-P-N EPITAXIAL PLANAR SILICON TRANSISTORS

TYPICAL CHARACTERISTICS

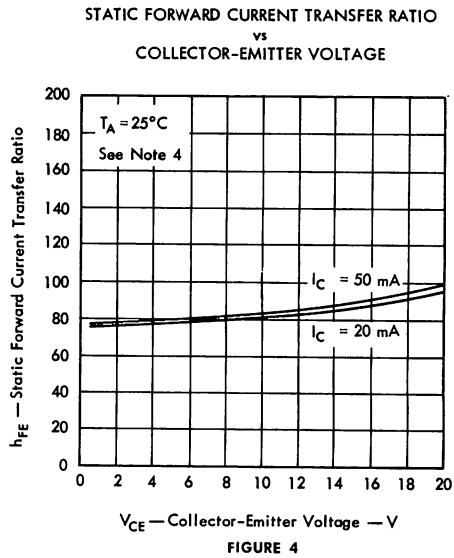
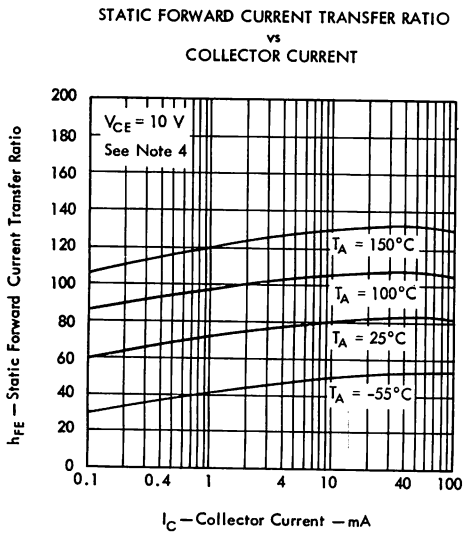
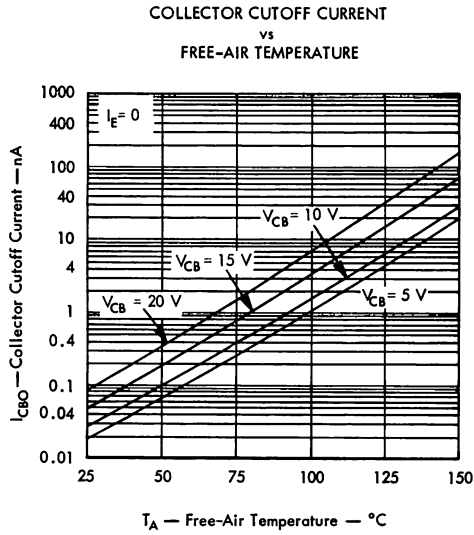

NOTE 4: These parameters must be measured using pulse techniques. $t_p = 300 \mu s$, duty cycle $\leq 2\%$.

TYPES 2N4874 THRU 2N4876

N-P-N EPITAXIAL PLANAR SILICON TRANSISTORS

TYPICAL CHARACTERISTICS

FORWARD BASE CURRENT
vs
BASE-SUPPLY VOLTAGE

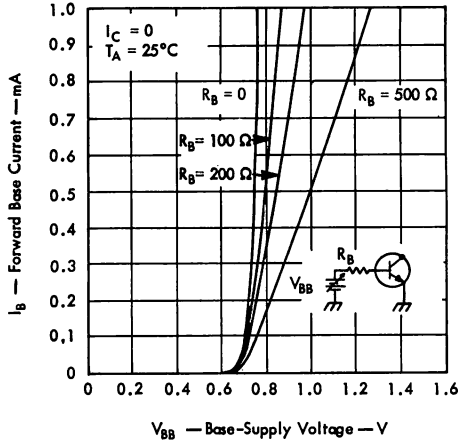

FIGURE 5

BASE-EMITTER VOLTAGE
vs
COLLECTOR CURRENT

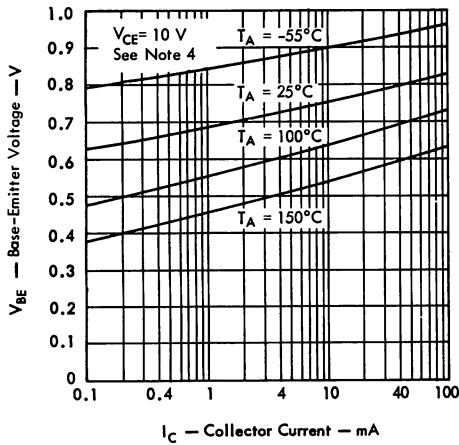

FIGURE 6

COLLECTOR-EMITTER SATURATION VOLTAGE
vs
COLLECTOR CURRENT

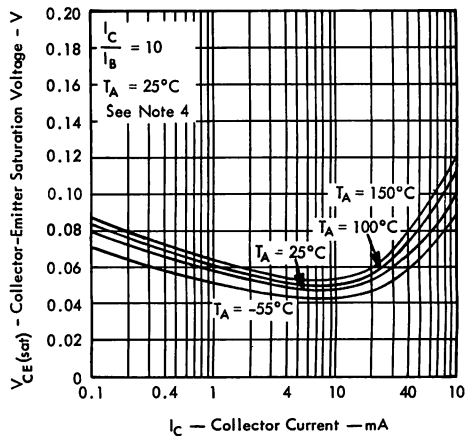

FIGURE 7

NOTE 4: These parameter must be measured using pulse techniques. $t_p = 300 \mu s$, duty cycle $\leq 2\%$.

TYPES 2N4874 THRU 2N4876

N-P-N EPITAXIAL PLANAR SILICON TRANSISTORS

TYPICAL CHARACTERISTICS

MAGNITUDE OF SMALL-SIGNAL COMMON-EMITTER
FORWARD CURRENT TRANSFER RATIO
vs
COLLECTOR CURRENT

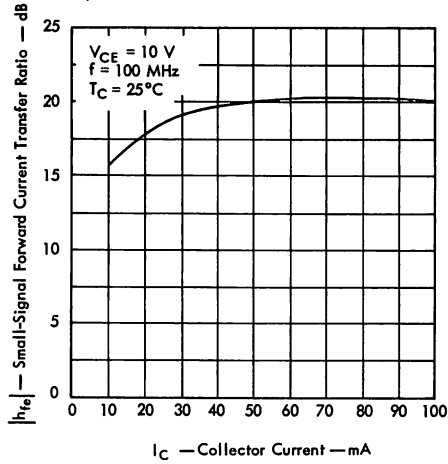

FIGURE 8

MAGNITUDE OF SMALL-SIGNAL
FORWARD CURRENT TRANSFER RATIO
vs
FREQUENCY

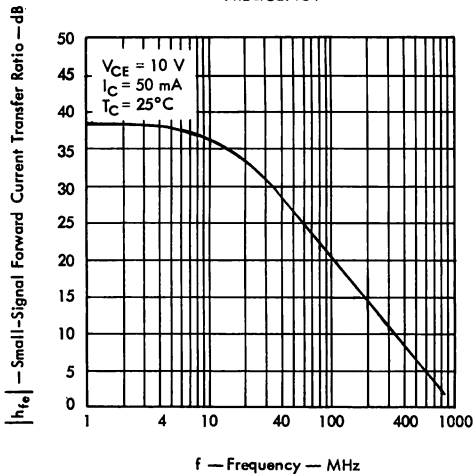

FIGURE 9

CONTOURS OF CONSTANT MAGNITUDE
OF SMALL-SIGNAL COMMON-EMITTER
FORWARD CURRENT TRANSFER RATIO — $|h_{fe}|$

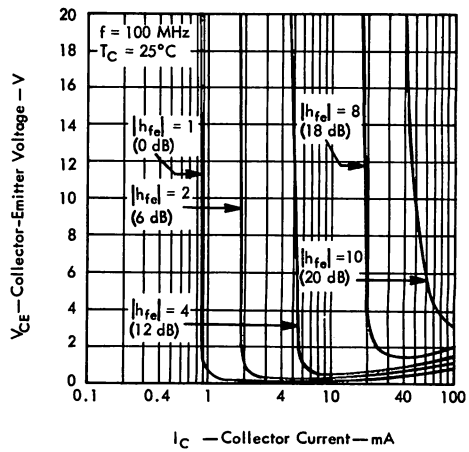

FIGURE 10

TYPES 2N4874 THRU 2N4876

N-P-N EPITAXIAL PLANAR SILICON TRANSISTORS

TYPICAL CHARACTERISTICS

SMALL-SIGNAL COMMON-EMITTER INPUT ADMITTANCE
vs
FREQUENCY

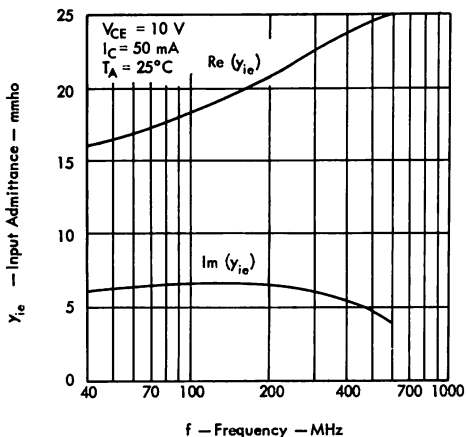

FIGURE 11

SMALL-SIGNAL COMMON-EMITTER
FORWARD TRANSFER ADMITTANCE
vs
FREQUENCY

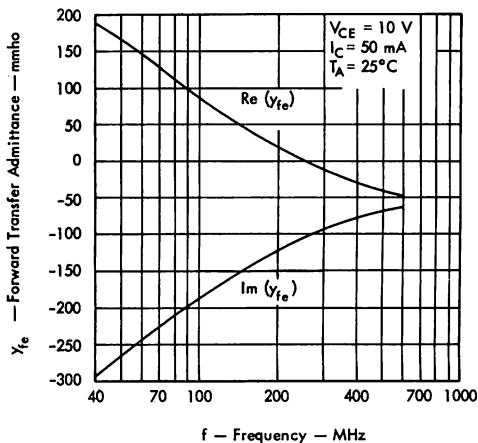

FIGURE 12

SMALL-SIGNAL COMMON-EMITTER
REVERSE TRANSFER ADMITTANCE
vs
FREQUENCY

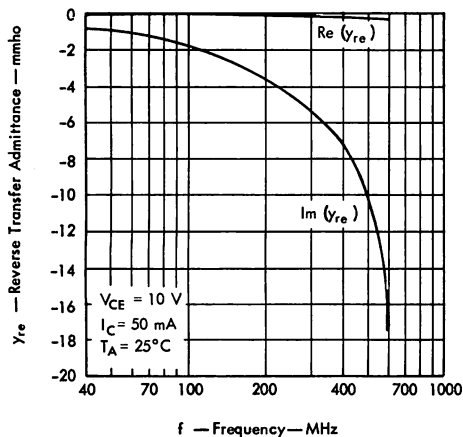

FIGURE 13

SMALL-SIGNAL COMMON-EMITTER
OUTPUT ADMITTANCE
vs
FREQUENCY

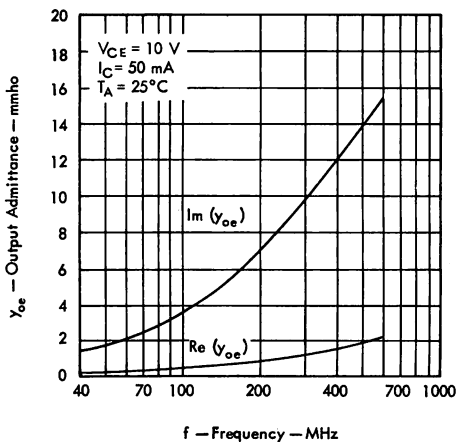

FIGURE 14

TYPES 2N4874 THRU 2N4876 N-P-N EPITAXIAL PLANAR SILICON TRANSISTORS

TYPICAL CHARACTERISTICS

COLLECTOR-BASE CAPACITANCE
vs
COLLECTOR-BASE VOLTAGE

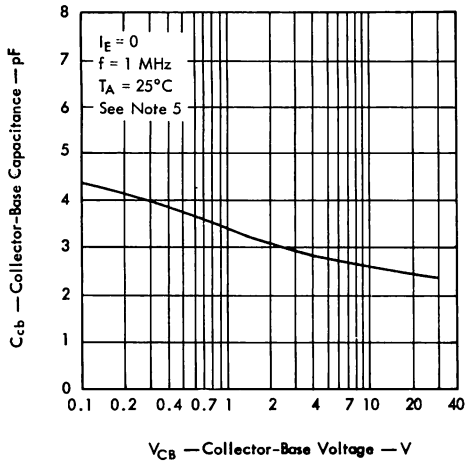

FIGURE 15

SPOT NOISE FIGURE
vs
FREQUENCY

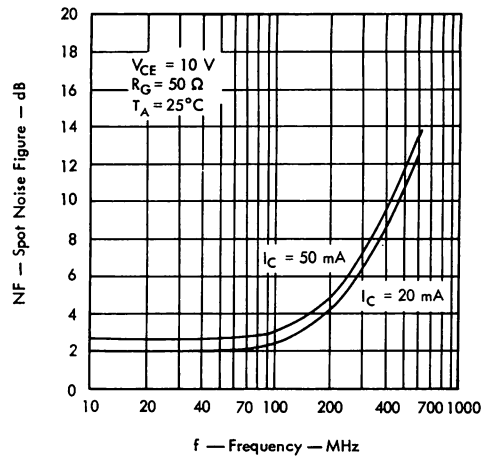

FIGURE 16

CROSS-MODULATION DISTORTION
vs
UNDESIRABLE-SIGNAL INPUT VOLTAGE

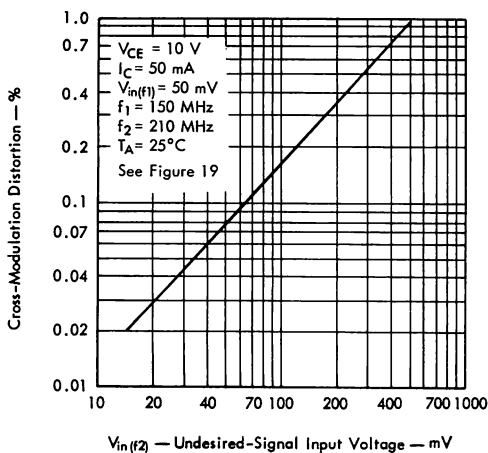

FIGURE 17

UNDESIRABLE-SIGNAL INPUT VOLTAGE
vs
COLLECTOR CURRENT

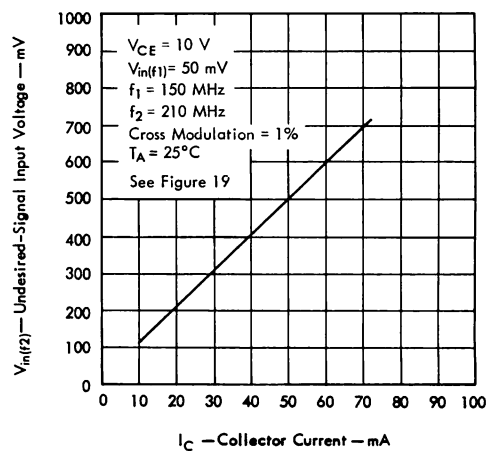

FIGURE 18

NOTE 5: Collector-Base Capacitance is measured using three-terminal measurement techniques with the emitter guarded.

TYPES 2N4874 THRU 2N4876

N-P-N EPITAXIAL PLANAR SILICON TRANSISTORS

PARAMETER MEASUREMENT INFORMATION

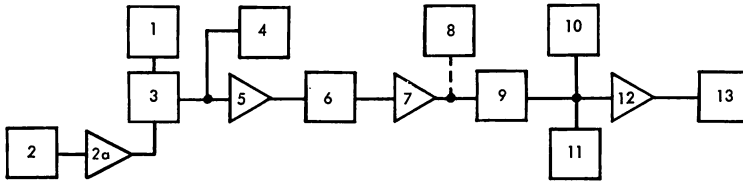

BLOCK DIAGRAM

- | | |
|--------------------------------------|-----------------------------------|
| 1. HP 608D Signal Generator | 7. Boonton 230A Power Amplifier |
| 2. HP 608D Signal Generator | 8. Boonton Model 91D RF Voltmeter |
| 2a. Boonton 230A Power Amplifier | 9. Telonic RF Detector |
| 3. Power Divider | 10. HP 412A D-C Voltmeter |
| 4. Boonton Model 91D RF Voltmeter | 11. HP 130A Oscilloscope |
| 5. Test Amplifier Shown Below | 12. 1-kHz Variable-Gain Amplifier |
| 6. HP Variable Attenuator (0-120 dB) | 13. HP 400H RMS Voltmeter |

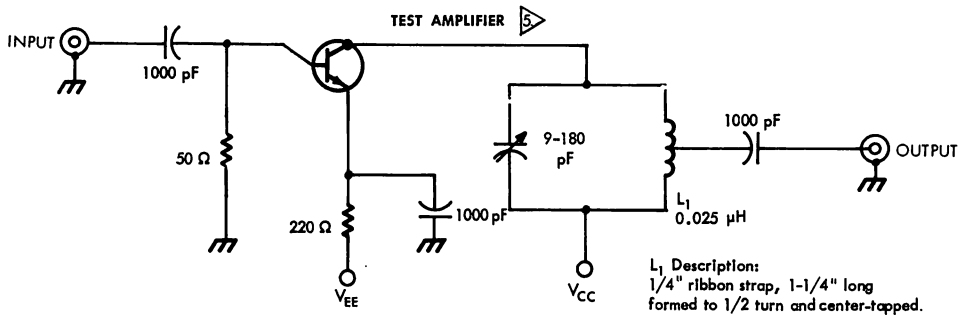

CALIBRATING AND OPERATING INSTRUCTIONS

- Set up equipment as shown in Block Diagram
- Calibration
 - Set signal generator **1** to desired-signal frequency ($f_1 = 150$ MHz).
 - Tune Boonton VHF Amplifier **7** to 150 MHz.
 - Set desired-signal level for 50 mV at input of test amplifier **5**.
 - Modulate desired signal 20% with 1 kHz.
 - Adjust variable attenuator **6** to give 0.45 V at input of RF Detector **9**.
 - Adjust gain of 1-kHz RF Voltmeter **12** for zero-dB reference on HP 400H **13**.
 - Set signal generator **2** to undesired-signal frequency ($f_2 = 210$ MHz).
 - Modulate undesired signal 30% with 1 kHz.
- Measurement
 - Remove modulation from signal generator **1**.
 - Increase the 30%-modulated undesired signal until a specified percentage of cross-modulation of the desired signal is indicated on the HP 400H **13**.
 - Record the undesired-signal voltage at the input of test amplifier **5** with desired signal turned off.
- This reading is the modulated undesired-signal voltage required to cause a specified percentage of cross-modulation on the desired-signal carrier.

FIGURE 19 — MEASUREMENT OF CROSS-MODULATION DISTORTION

TYPES 3N74, 3N75, 3N76, 3N77, 3N78, 3N79 N-P-N PLANAR SILICON TRANSISTORS



TYPES 3N74, 3N75, 3N76, 3N77, 3N78, 3N79
BULLETIN NO. DL-5 683659 MARCH 1963
REVISED MAY 1968

DOUBLE-EMITTER PLANAR TRANSISTORS DESIGNED FOR CHOPPER APPLICATIONS

- Low Offset Voltage
- Excellent Thermal Stability
- Very Low Leakage—2 na max at 15 v (3N74, 3N75, 3N76)
- High Breakdown Voltage—18 v min (3N74, 3N75, 3N76)

*mechanical data

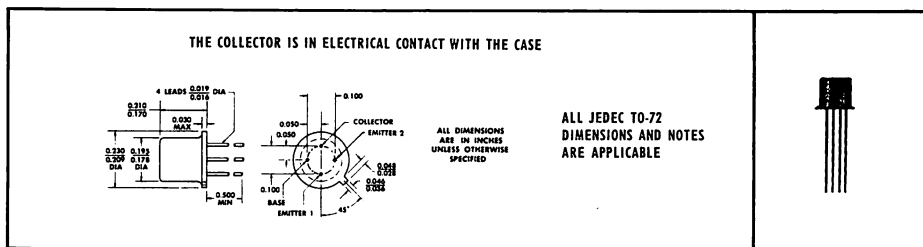

*absolute maximum ratings at 25°C free-air temperature (unless otherwise noted)

	3N74	3N77
	3N75	3N78
	3N76	3N79
Collector-Base Voltage	50 v	40 v
Emitter-One—Collector Voltage (See Note 1).	18 v	12 v
Emitter-Two—Collector Voltage (See Note 1).	18 v	12 v
Emitter-One—Emitter-Two Voltage (See Note 2).	18 v	12 v
Emitter-One—Base Voltage (See Note 3)	18 v	12 v
Emitter-Two—Base Voltage (See Note 3)	18 v	12 v
Collector Current	← 20 ma →	← 20 ma →
Base Current	← 20 ma →	← 20 ma →
Emitter-One Current	← 10 ma →	← 10 ma →
Emitter-Two Current	← 10 ma →	← 10 ma →
Total Device Dissipation at (or below) 25°C Free-Air Temperature (See Note 4)	← 300 mw →	← 300 mw →
Total Device Dissipation at (or below) 25°C Case Temperature (See Note 5)	← 600 mw →	← 600 mw →
Storage Temperature Range	- 65°C to + 200°C	

- NOTES: 1. This value applies when the base and alternate emitter are open-circuited.
 2. This value applies when the collector is short-circuited to the base but open-circuited with respect to the emitters.
 3. This value applies when the collector and alternate emitter are open-circuited.
 4. Derate linearly to 175°C free-air temperature at the rate of 2 mw/°C.
 5. Derate linearly to 175°C case temperature at the rate of 4 mw/°C.

*Indicates JEDEC registered data



TYPES 3N74, 3N75, 3N76, 3N77, 3N78, 3N79

N-P-N PLANAR SILICON TRANSISTORS

*electrical characteristics at 25°C free-air temperature (unless otherwise noted)

PARAMETER	TEST CONDITIONS	3N74		3N75		3N76		UNIT		
		MIN	MAX	MIN	MAX	MIN	MAX			
BV_{CBO}	Collector-Base Breakdown Voltage	$I_C = 100 \mu A, I_{E1} = I_{E2} = 0$		50		50		50	v	
BV_{E1BO} BV_{E2BO}	Emitter-Base Breakdown Voltage	I_{E1} (or I_{E2}) = 10 μA I_{E2} (or I_{E1}) = 0, $I_C = 0$		18		18		18	v	
BV_{E1E2}	Emitter-Emitter Breakdown Voltage	$I_{E1} = \pm 10 \mu A, V_{CB} = 0$ (See Note 6)		± 18		± 18		± 18	v	
I_{CBO}	Collector Cutoff Current	$V_{CB} = 30$ v, $I_{E1} = I_{E2} = 0$		10		10		10	na	
I_{E1BO} I_{E2BO}	Emitter Cutoff Current	V_{E1B} (or V_{E2B}) = 15 v I_{E2} (or I_{E1}) = $I_C = 0$		2		2		2	na	
I_{E1E2}	Emitter Cutoff Current	$V_{E1E2} = \pm 15$ v, $V_{CB} = 0$ (See Note 6)		± 2		± 2		± 2	na	
		$V_{E1E2} = \pm 15$ v, $V_{CB} = 0$ $T_A = 100^\circ C$, (See Note 6)		± 100		± 100		± 100	na	
$ V_{E1E2} $	Offset Voltage	$I_B = 1$ ma, $I_{E1} = I_{E2} = 0$ $T_A = -25^\circ C, +25^\circ C$, and $+100^\circ C$ (See Figure 1)		50		100		200	μv	
$ \Delta V_{E1E2} _{\Delta I_B}$	Offset Voltage Change With Base Current†	$I_{B(1)} = 1.5$ ma, $I_{B(2)} = 0.5$ ma $I_{E1} = I_{E2} = 0$		25		25		50	μv	
$ \Delta V_{E1E2} _{\Delta T_A}$	Offset Voltage Change With Temperature†	$I_B = 1$ ma, $I_{E1} = I_{E2} = 0$ $T_{A(1)} = 100^\circ C, T_{A(2)} = -25^\circ C$		75		125		175	μv	
$ h_{fe1} $ $ h_{fe2} $	Small-Signal Common-Emitter Forward Current Transfer Ratio	V_{CE1} (or V_{CE2}) = 5 v, I_{E2} (or I_{E1}) = 0 $I_C = 1$ ma, $f = 20$ mc		1.5		1.5		1.5		
C_{ob}	Common-Base Open-Circuit Output Capacitance	$V_{CB} = 5$ v, $I_{E1} = I_{E2} = 0$ $f = 140$ kc		8		8		8	pf	
C_{o1b} C_{o2b}	Common-Base Open-Circuit Input Capacitance	V_{E1B} (or V_{E2B}) = 5 v I_{E2} (or I_{E1}) = 0 $I_C = 0, f = 140$ kc		5		5		5	pf	
r_{o1o2}	Dynamic On Series Resistance	$I_B = 1$ ma, $I_{E1} = I_{E2} = 0$ $I_{o1} = 100 \mu A, f = 1$ kc (See Figure 2)		10	40	10	40	10	50	ohm

6. These parameters must be measured with the collector short-circuited to the base but open-circuited with respect to the emitters.

† Offset Voltage Change is defined as the magnitude of the algebraic difference between the offset voltage at the higher base current (or temperature) and the offset voltage at the lower base current (or temperature).

*Indicates JEDEC registered data

TYPES 3N74, 3N75, 3N76, 3N77, 3N78, 3N79

N-P-N PLANAR SILICON TRANSISTORS

*electrical characteristics at 25°C free-air temperature (unless otherwise noted)

PARAMETER	TEST CONDITIONS	3N77		3N78		3N79		UNIT
		MIN	MAX	MIN	MAX	MIN	MAX	
BV_{CBO} } Collector-Base Breakdown Voltage	$I_C = 100 \mu A, I_{E1} = I_{E2} = 0$	40		40		40		v
BV_{E1BO} } BV_{E2BO} } Emitter-Base Breakdown Voltage	I_{E1} (or I_{E2}) = 10 μA I_{E2} (or I_{E1}) = 0, $I_C = 0$	12		12		12		v
BV_{E1E2} } Emitter-Base Breakdown Voltage	$I_{E1} = \pm 10 \mu A, V_{CB} = 0$ (See Note 6)	± 12		± 12		± 12		v
I_{CBO} } Collector Cutoff Current	$V_{CB} = 30 v, I_{E1} = I_{E2} = 0$		10		10		20	na
I_{E1BO} } I_{E2BO} } Emitter Cutoff Current	V_{E1B} (or V_{E2B}) = 5 v I_{E2} (or I_{E1}) = $I_C = 0$		5		5		10	na
I_{E1E2} } Emitter Cutoff Current	$V_{E1E2} = \pm 5 v, V_{CB} = 0$ (See Note 6)		± 5		± 5		± 10	na
	$V_{E1E2} = \pm 5 v, V_{CB} = 0$ $T_A = 100^\circ C$, (See Note 6)		± 100		± 100		± 200	na
$ V_{E1E2} $ } Offset Voltage	$I_B = 1 ma, I_{E1} = I_{E2} = 0$ $T_A = -25^\circ C, +25^\circ C$, and $+100^\circ C$ (See Figure 1)		50		100		200	μV
$ \Delta V_{E1E2} _{\Delta I_B}$ } Offset Voltage Change With Base Current†	$I_{B(1)} = 1.5 ma, I_{B(2)} = 0.5 ma$ $I_{E1} = I_{E2} = 0$		25		50		75	μV
$ \Delta V_{E1E2} _{\Delta T_A}$ } Offset Voltage Change With Temperature†	$I_B = 1 ma, I_{E1} = I_{E2} = 0$ $T_{A(1)} = 100^\circ C, T_{A(2)} = -25^\circ C$		75		125		175	μV
$ h_{fe1} $ } $ h_{fe2} $ } Small-Signal Common-Emitter Forward Current Transfer Ratio	V_{CE1} (or V_{CE2}) = 5 v, I_{E2} (or I_{E1}) = 0 $I_C = 1 ma, f = 20 mc$	1.5		1.5		1.5		
C_{ob} } Common-Base Open-Circuit Output Capacitance	$V_{CB} = 5 v, I_{E1} = I_{E2} = 0$ $f = 140 kc$		8		8		10	pf
C_{o1b} } C_{o2b} } Common-Base Open-Circuit Input Capacitance	V_{E1B} (or V_{E2B}) = 5 v I_{E2} (or I_{E1}) = 0 $I_C = 0, f = 140 kc$		5		5		6	pf
r_{o1e2} } Dynamic On Series Resistance	$I_B = 1 ma, I_{E1} = I_{E2} = 0$ $I_{o1} = 100 \mu A, f = 1 kc$ (See Figure 2)	10	50	10	50	10	60	ohm

6. These parameters must be measured with the collector short-circuited to the base but open-circuited with respect to the emitters.

† Offset Voltage Change is defined as the magnitude of the algebraic difference between the offset voltage at the higher base current (or temperature) and the offset voltage at the lower base current (or temperature).

*Indicates JEDEC registered data

TYPES 3N74, 3N75, 3N76, 3N77, 3N78, 3N79

N-P-N PLANAR SILICON TRANSISTORS

*PARAMETER MEASUREMENT INFORMATION

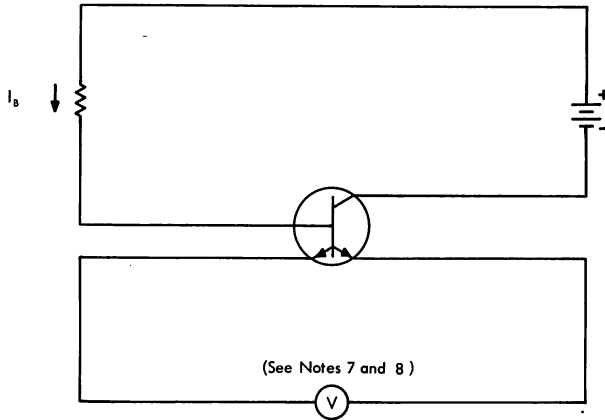

FIGURE 1 — OFFSET VOLTAGE TEST CIRCUIT

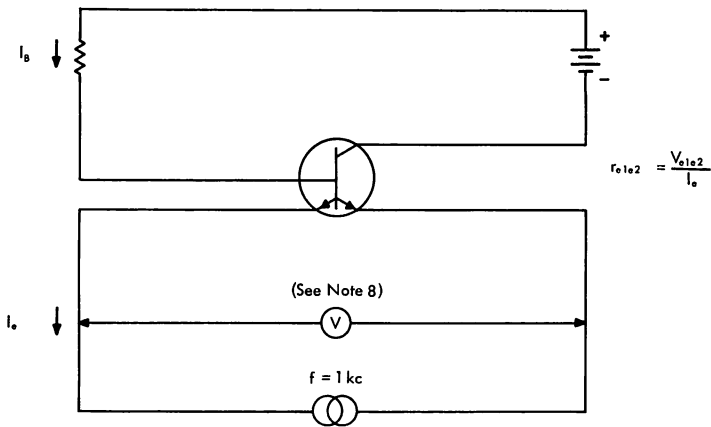

FIGURE 2 — ON SERIES RESISTANCE TEST CIRCUIT

NOTES: 7. Care must be taken to avoid error due to thermocouple action.

8. The voltmeter impedance must be high enough that halving it does not change the measured value.

*Indicates JEDEC registered data

N-P-N TYPES TIS90, TIS90M, TIS92, TIS92M P-N-P TYPES TIS91, TIS91M, TIS93, TIS93M COMPLEMENTARY EPITAXIAL PLANAR SILICON TRANSISTORS



TYPES TIS90 THRU TIS93, TIS90M THRU TIS93M
BULLETIN NO. DL-5 6710224, JULY 1967

SILECT† COMPLEMENTARY TRANSISTORS

**Available in Matched Complementary Pairs (TIS90M thru TIS93M)
for Complementary-Symmetry or Other Class-B Audio-Amplifier Applications**

- Supplied in Color-Coded h_{FE} Brackets of 3-dB-Maximum Range
- 1.6-W Rating at 25°C Case Temperature

mechanical data

These transistors are encapsulated in a plastic compound specifically designed for this purpose, using a highly mechanized process‡ developed by Texas Instruments. The case will withstand soldering temperatures without deformation. These devices exhibit stable characteristics under high-humidity conditions and are capable of meeting MIL-STD-202C method 106B. The transistors are insensitive to light.

High-thermal-conductivity leads allow operation at unusually high dissipation levels.

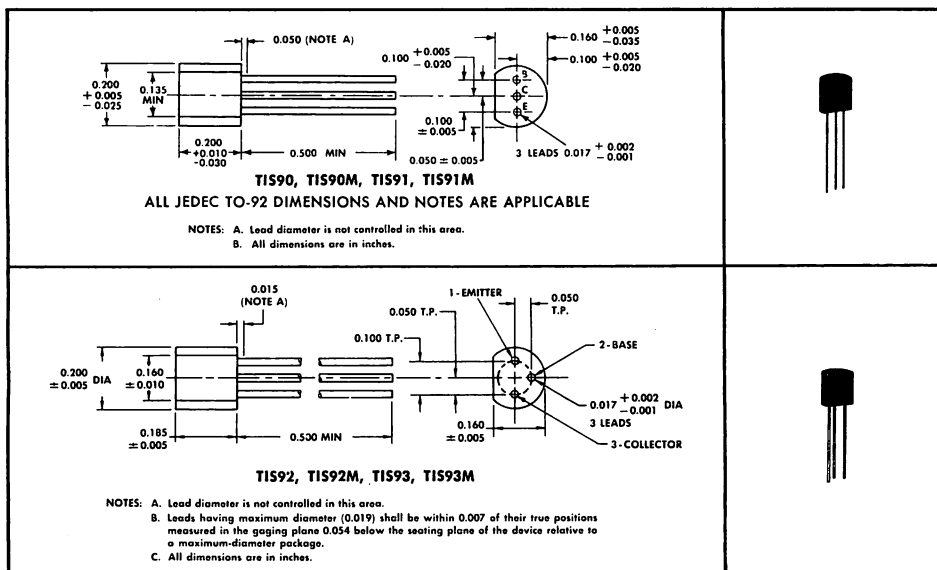

absolute maximum ratings at 25°C free-air temperature (unless otherwise noted)§

Collector-Base Voltage	40 V
Collector-Emitter Voltage (See Note 1)	40 V
Emitter-Base Voltage	5 V
Continuous Collector Current	400 mA
Continuous Device Dissipation at (or below) 25°C Free-Air Temperature (See Note 2)	625 mW
Continuous Device Dissipation at (or below) 25°C Lead Temperature (See Note 3)	1.25 W
Continuous Device Dissipation at (or below) 25°C Case-and-Lead Temperature (See Note 4)	1.6 W
Storage Temperature Range	-65°C to 150°C
Lead Temperature 1/16 Inch from Case for 10 Seconds	260°C

- NOTES: 1. This value applies when the base-emitter diode is open-circuited.
 2. Derate linearly to 150°C free-air temperature at the rate of 5 mW/deg.
 3. Derate linearly to 150°C lead temperature at the rate of 10 mW/deg.
 Lead temperature is measured on the collector lead 1/16 inch from the case.
 4. This rating applies with the entire case (including the leads) maintained at 25°C.
 Derate linearly to 150°C case-and-lead temperature at the rate of 12.8 mW/deg.

†Trademark of Texas Instruments
 ‡Patent pending
 §Voltages and currents apply to the n-p-n transistors.
 For the p-n-p transistors the values are the same, but the polarities are reversed.



N-P-N TYPES TIS90, TIS90M, TIS92, TIS92M P-N-P TYPES TIS91, TIS91M, TIS93, TIS93M COMPLEMENTARY EPITAXIAL PLANAR SILICON TRANSISTORS

electrical characteristics at 25°C free-air temperature

PARAMETER	TEST CONDITIONS†	N-P-N			P-N-P			UNIT
		TIS90, TIS90M TIS92, TIS92M			TIS91, TIS91M TIS93, TIS93M			
		MIN	TYP	MAX	MIN	TYP	MAX	
$V_{(BR)CBO}$ Collector-Base Breakdown Voltage	$I_C = 100 \mu A, I_E = 0$	40			-40			V
$V_{(BR)CEO}$ Collector-Emitter Breakdown Voltage	$I_C = 10 \text{ mA}, I_B = 0, \text{ See Note 5}$	40			-40			V
$V_{(BR)EBO}$ Emitter-Base Breakdown Voltage	$I_E = 100 \mu A, I_C = 0$	5			-5			V
I_{CBO} Collector Cutoff Current	$V_{CB} = 20 \text{ V}, I_E = 0$	100			-100			nA
I_{EBO} Emitter Cutoff Current	$V_{EB} = 3 \text{ V}, I_C = 0$	100			-100			nA
h_{FE} Static Forward Current Transfer Ratio	$V_{CE} = 2 \text{ V}, I_C = 50 \text{ mA}, \text{ See Note 5}$	100	160	300	100	160	300	
V_{BE} Base-Emitter Voltage	$V_{CE} = 2 \text{ V}, I_C = 50 \text{ mA}, \text{ See Note 5}$	0.6	0.77	1	-0.6	-0.76	-1	V
$V_{CE(sat)}$ Collector-Emitter Saturation Voltage	$I_B = 5 \text{ mA}, I_C = 50 \text{ mA}, \text{ See Note 5}$	0.04	0.25		-0.06	-0.25		V
	$I_B = 20 \text{ mA}, I_C = 200 \text{ mA}, \text{ See Note 5}$	0.17			-0.23			V

NOTE 5: These parameters must be measured using pulse techniques. $t_p = 300 \mu s$, duty cycle $\leq 2\%$.

†Test condition voltages and currents apply to the n-p-n transistors. For the p-n-p transistors the values are the same, but the polarities are reversed.

PARAMETER COLOR-CODE INFORMATION

To facilitate matching and identification these transistors are color-coded in h_{FE} brackets, each having a maximum spread of 3 dB as shown in the table below. No guarantee is made as to distribution of h_{FE} values, except that equal numbers of n-p-n and p-n-p devices will be shipped in any given bracket when matched complementary pairs are ordered. To order from specific brackets, contact a TI sales office or distributor.

COLOR CODE	YELLOW	GREEN	BLUE	VIOLET	GRAY
h_{FE} Range, $ V_{CE} = 2 \text{ V}, I_C = 50 \text{ mA}$	100 - 125	115 - 150	140 - 190	170 - 235	215 - 300

ORDERING INFORMATION — To order matched complementary pairs, order the same quantity each of TIS90M and TIS91M or TIS92M and TIS93M. Devices may be ordered separately by specifying TIS90, TIS91, TIS92, or TIS93.

THERMAL INFORMATION

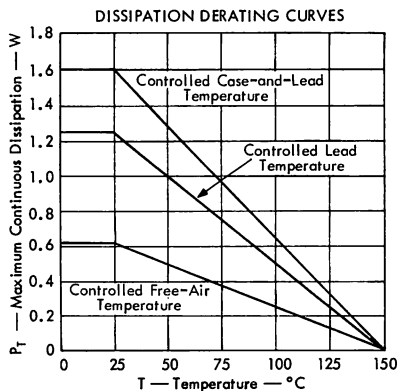

FIGURE 1

N-P-N TYPES TIS90, TIS90M, TIS92, TIS92M P-N-P TYPES TIS91, TIS91M, TIS93, TIS93M COMPLEMENTARY EPITAXIAL PLANAR SILICON TRANSISTORS

TYPICAL CHARACTERISTICS

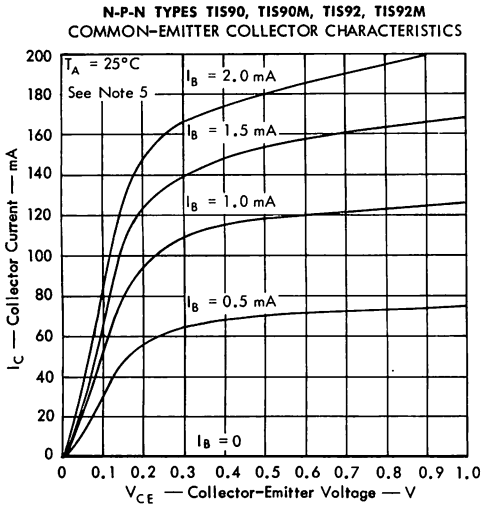

FIGURE 2

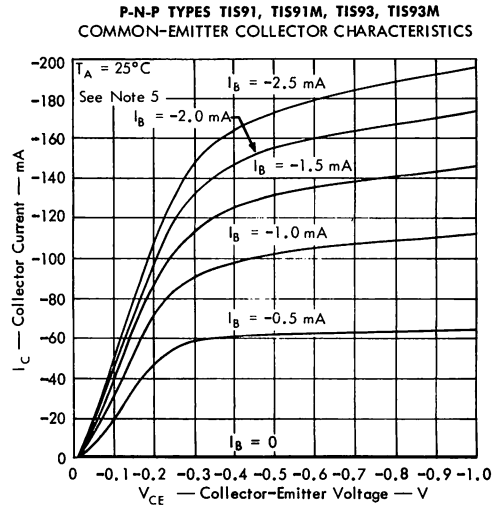

FIGURE 3

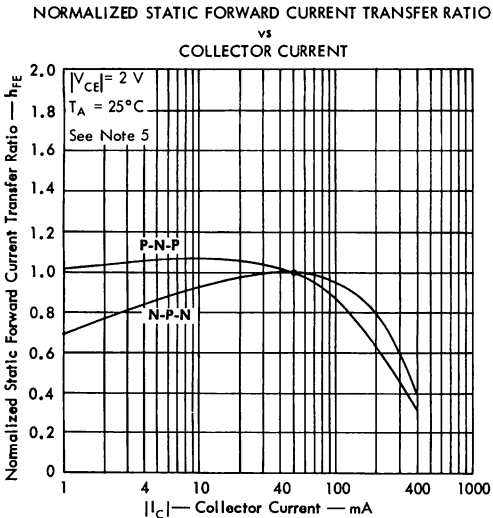

FIGURE 4

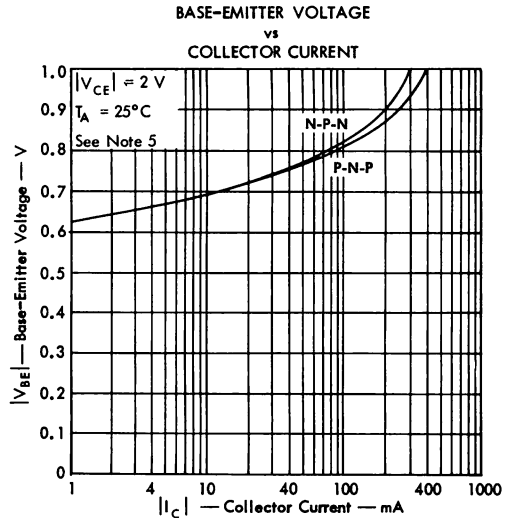
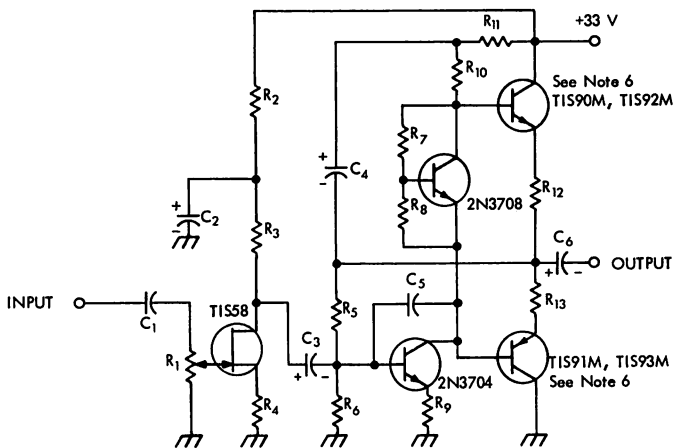

FIGURE 5

NOTE 5: These parameters must be measured using pulse techniques. $t_p = 300 \mu s$, duty cycle $\leq 2\%$.

N-P-N TYPES TIS90, TIS90M, TIS92, TIS92M P-N-P TYPES TIS91, TIS91M, TIS93, TIS93M COMPLEMENTARY EPITAXIAL PLANAR SILICON TRANSISTORS

TYPICAL APPLICATION DATA



CIRCUIT COMPONENT INFORMATION

RESISTORS			CAPACITORS
R ₁ : 1 MΩ	R ₆ : 1.3 kΩ	R ₁₁ : 300 Ω	C ₁ : 0.05 μF
R ₂ : 2 kΩ	R ₇ : 200 Ω	R ₁₂ : 3.9 Ω	C ₂ : 50 μF, 30 V, electrolytic
R ₃ : 2 kΩ	R ₈ : 360 Ω	R ₁₃ : 3.9 Ω	C ₃ : 5 μF, 30 V, electrolytic
R ₄ : 100 Ω	R ₉ : 10 Ω		C ₄ : 20 μF, 20 V, electrolytic
R ₅ : 24 kΩ	R ₁₀ : 1.2 kΩ		C ₅ : 330 pF
All resistors 1/2 W, ten percent tolerance			C ₆ : 100 μF, 35 V, electrolytic

TYPICAL PERFORMANCE, R _L = 40 Ω, f = 1 kHz, T _A = 25°C (EXCEPT WHERE NOTED)	
Sensitivity at 1-W Output	100 mV
Input Impedance	1 MΩ
Total Harmonic Distortion at 2-W Output	3.7%
Total Harmonic Distortion at 1-W Output	1.2%
Total Harmonic Distortion at 50-mW Output	0.15%
Frequency Response	Down 3 dB at 63 Hz and 17 kHz
Power Supply Drain at Zero Signal	15 mA
Power Supply Drain at Rated Output	115 mA

NOTE 6: Heat sink the collector lead.

FIGURE 6 — TYPICAL 2-WATT COMPLEMENTARY AMPLIFIER

TYPES 3N108, 3N109, 3N110, 3N111 P-N-P EPITAXIAL PLANAR SILICON TRANSISTORS



TYPES 3N108, 3N109, 3N110, 3N111
BULLETIN NO. DL-S-6810485, MAY 1968
REPLACES BULLETIN NO. DL-S-657302, MARCH 1965

HIGH-VOLTAGE DOUBLE-EMITTER PLANAR TRANSISTORS DESIGNED FOR LOW-LEVEL, HIGH-SPEED CHOPPER APPLICATIONS REQUIRING VERY LOW OFFSET VOLTAGE

- May be Used in Some Circuits Designed for N-P-N Types by Reversing Collector and Base Terminations
- High Breakdown Voltages . . . 50 V Min (3N108, 3N109)
- Low Offset-Voltage/Temperature Sensitivity
- Extremely Low Leakage . . . 0.1 nA Max at 25 V (3N108, 3N109)
- Military Version (JAN3N108) Available

*mechanical data

THE COLLECTOR IS IN ELECTRICAL CONTACT WITH THE CASE.

ALL JEDEC TO-72* DIMENSIONS AND NOTES ARE APPLICABLE

ALL DIMENSIONS ARE IN INCHES UNLESS OTHERWISE SPECIFIED

*TO-72 outline is same as TO-18 outline with the addition of a fourth lead.

*absolute maximum ratings at 25°C free-air temperature (unless otherwise noted)

	3N108	3N109	3N110	3N111
Collector-Base Voltage	-50 V	-50 V	-50 V	-50 V
Emitter-One-Collector Voltage (See Note 1)	-50 V	-50 V	-30 V	-30 V
Emitter-Two-Collector Voltage (See Note 1)	-50 V	-50 V	-30 V	-30 V
Emitter-One-Emitter-Two Voltage (See Note 2)	±50 V	±50 V	±30 V	±30 V
Emitter-One-Base Voltage	-50 V	-50 V	-30 V	-30 V
Emitter-Two-Base Voltage	-50 V	-50 V	-30 V	-30 V
Continuous Collector Current	← ±20 mA →	← ±20 mA →	← ±20 mA →	← ±20 mA →
Continuous Base Current	← ±20 mA →	← ±20 mA →	← ±20 mA →	← ±20 mA →
Continuous Emitter-One Current	← ±10 mA →	← ±10 mA →	← ±10 mA →	← ±10 mA →
Continuous Emitter-Two Current	← ±10 mA →	← ±10 mA →	← ±10 mA →	← ±10 mA →
Continuous Device Dissipation at (or below) 25°C Free-Air Temperature (See Note 3)	← 300 mW →	← 300 mW →	← 300 mW →	← 300 mW →
Continuous Device Dissipation at (or below) 25°C Case Temperature (See Note 4)	← 600 mW →	← 600 mW →	← 600 mW →	← 600 mW →
Storage Temperature Range	-65°C to 200°C	-65°C to 200°C	-65°C to 200°C	-65°C to 200°C
Lead Temperature 1/8 Inch from Case for 10 Seconds	← 300°C →	← 300°C →	← 300°C →	← 300°C →

- NOTES: 1. This value applies between 0 and 10 mA collector current when the base and alternate emitter are open-circuited.
 2. This value applies when the collector is short-circuited to the base but open-circuited with respect to the emitters.
 3. Derate linearly to 200°C free-air temperature at the rate of 1.71 mW/dag.
 4. Derate linearly to 200°C case temperature at the rate of 3.43 mW/dag.

*Indicates JEDEC registered data

TYPES 3N108, 3N109, 3N110, 3N111

P-N-P EPITAXIAL PLANAR SILICON TRANSISTORS

*electrical characteristics at 25°C free-air temperature (unless otherwise noted)

PARAMETER	TEST CONDITIONS	3N108		3N109		3N110		3N111		UNIT
		MIN	MAX	MIN	MAX	MIN	MAX	MIN	MAX	
$V_{(BR)CBO}$	Collector-Base Breakdown Voltage $I_C = -1 \mu A, I_{E1} = I_{E2} = 0$	-50		-50		-50		-50		V
$V_{(BR)ECO}$	Emitter-Collector Breakdown Voltage $I_E = -1 \mu A, I_B = 0$, See Note 5	-50		-50		-30		-30		V
$V_{(BR)EBO}$	Emitter-Base Breakdown Voltage $I_E = -1 \mu A, I_C = 0$, See Note 5	-50		-50		-30		-30		V
$V_{(BR)E1-E2}$	Emitter-Emitter Breakdown Voltage $I_{E1} = \pm 1 \mu A, V_{CB} = 0$, See Note 6	± 50		± 50		± 30		± 30		V
I_{CBO}	Collector Cutoff Current $V_{CB} = -30 V, I_{E1} = I_{E2} = 0$	-0.25		-0.25		-0.5		-0.5		nA
I_{EBO}	Emitter Cutoff Current $V_{EB} = -25 V, I_C = 0$, See Note 5	-0.1		-0.1		-0.5		-0.5		nA
$I_{E1-E2(off)}$	Emitter Cutoff Current $V_{E1-E2} = \pm 25 V, V_{CB} = 0$, See Note 6 $V_{E1-E2} = \pm 25 V, V_{CB} = 0$, $T_A = 100^\circ C$, See Note 6	± 0.1		± 0.1		± 0.5		± 0.5		nA
		± 10		± 10		± 50		± 50		nA
$ V_{E1-E2(off)} $	Emitter-Emitter Offset Voltage $I_B = -1 mA, I_{E1} = I_{E2} = 0$, See Figure 1, $T_A = -25^\circ C, 25^\circ C$, and $100^\circ C$	30		150		30		150		μV
$ \Delta V_{E1-E2(off)} _{\Delta I_B}$	Offset Voltage Change With Base Current† $I_{B(1)} = -1.5 mA, I_{B(2)} = -0.5 mA, I_{E1} = I_{E2} = 0$	20		50		20		50		μV
$ \Delta V_{E1-E2(off)} _{\Delta T_A}$	Offset Voltage Change With Temperature† $I_B = -1 mA, I_{E1} = I_{E2} = 0, T_{A(1)} = 100^\circ C$, $T_{A(2)} = -25^\circ C$	50		150		50		150		μV
$r_{e1-e2(on)}$	Small-Signal Emitter-Emitter On-State Resistance $I_B = -1 mA, I_{E1} = I_{E2} = 0, I_o = 100 \mu A$, See Figure 2	10	50	10	50	10	50	10	50	Ω
$ h_{fe} $	Small-Signal Common-Emitter Forward Current Transfer Ratio $V_{CE} = -6 V, I_C = -1 mA, f = 4 MHz$, See Note 5	3		3		3		3		
C_{obo}	Common-Base Open-Circuit Output Capacitance $V_{CB} = -6 V, I_{E1} = I_{E2} = 0, f = 1 MHz$	10		10		10		10		pF
C_{ibo}	Common-Base Open-Circuit Input Capacitance $V_{EB} = -6 V, I_C = 0, f = 1 MHz$, See Note 5	3		3		3		3		pF

NOTES: 5. These limits apply separately for each emitter with the alternate emitter open-circuited.

6. These parameters must be measured with the collector short-circuited to the base but open-circuited with respect to the emitters. The limits apply to both polarities of emitter-to-emitter voltage.

†Offset Voltage Change is defined as the magnitude of the algebraic difference between the offset voltages at two specified base currents or temperatures.

*PARAMETER MEASUREMENT INFORMATION

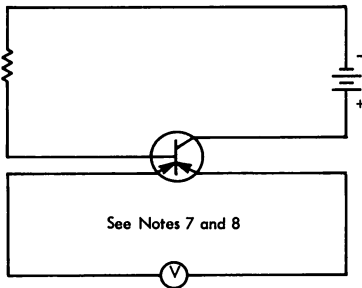

FIGURE 1 — OFFSET VOLTAGE TEST CIRCUIT

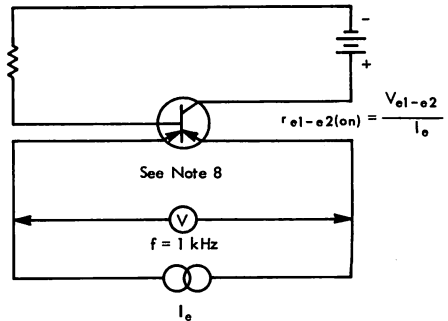

FIGURE 2 — SMALL-SIGNAL EMITTER-EMITTER ON-STATE RESISTANCE TEST CIRCUIT

NOTES: 7. Care must be taken to avoid error due to thermocouple action.

8. The voltmeter impedance must be high enough that halving it does not change the measured value.

*Indicates JEDEC registered data

TYPES 3N108, 3N109, 3N110, 3N111 P-N-P EPITAXIAL PLANAR SILICON TRANSISTORS

TYPICAL CHARACTERISTICS

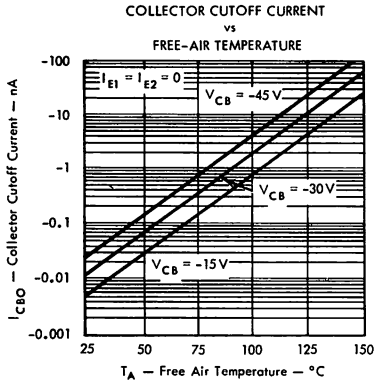

FIGURE 3

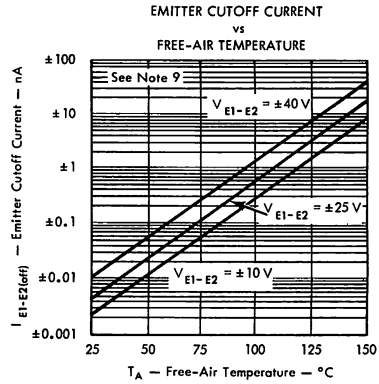

FIGURE 4

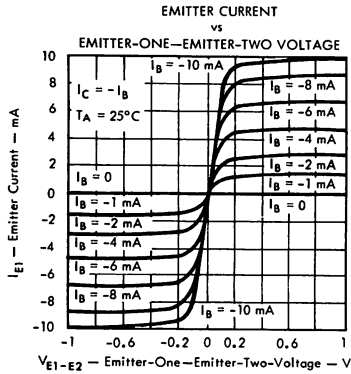

FIGURE 5

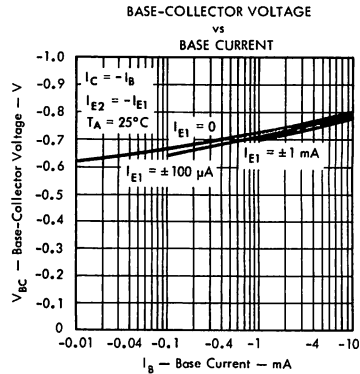

FIGURE 6

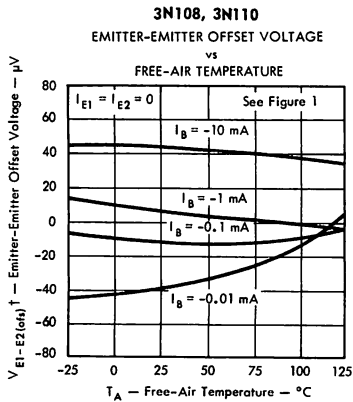

FIGURE 7

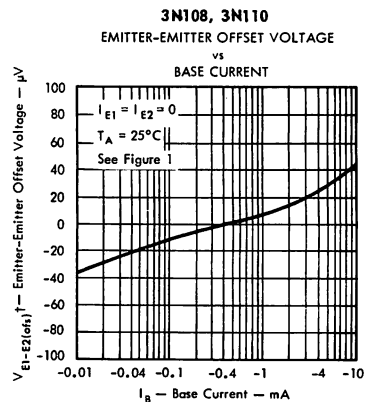

FIGURE 8

NOTE 9: This parameter is measured with the collectors short-circuited to the base but open-circuited with respect to the emitters.

†The polarity of the offset voltage at $T_A = 25^\circ C$ and $I_B = -1\text{ mA}$ is arbitrarily assumed to be positive.

TYPES 3N108, 3N109, 3N110, 3N111

P-N-P EPITAXIAL PLANAR SILICON TRANSISTORS

TYPICAL CHARACTERISTICS

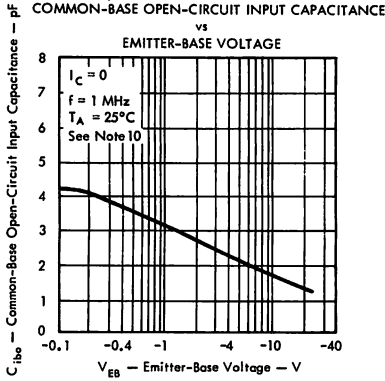

FIGURE 9

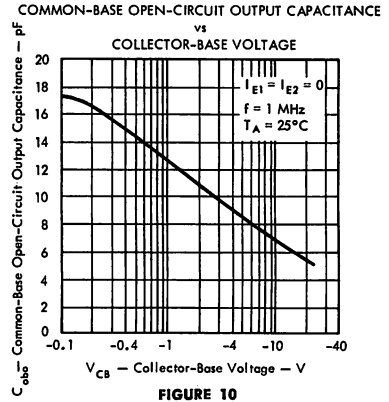

FIGURE 10

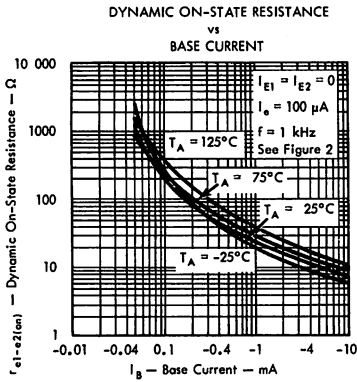

FIGURE 11

NOTE 10: This curve applies separately for each emitter with the alternate emitter open-circuited.

THERMAL INFORMATION

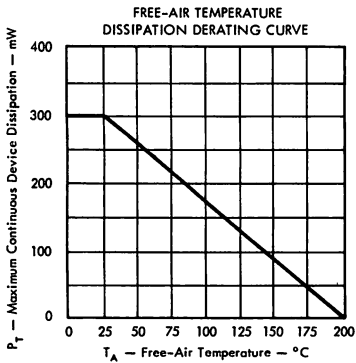

FIGURE 12

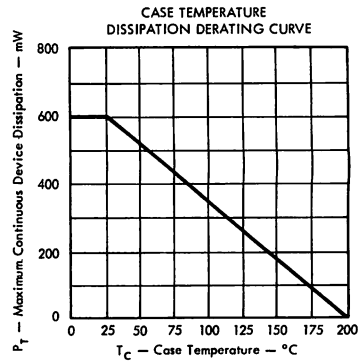

FIGURE 13

TYPE 2N997 N-P-N PLANAR SILICON TRANSISTOR



TYPE 2N997
BULLETIN NO. DS-5 683576, FEBRUARY, 1968
REVISED MAY 1968

TWO TRIODES INTERNALLY CONNECTED IN DARLINGTON CONFIGURATION

- Very High Gain—1000 min at 100 μ a
- Low Leakage—10 na max at 60 v
- Rugged Internal Connections

*mechanical data

3 LEADS 0.019 DIA
0.210 0.016
0.030 MAX
0.270 0.105
0.200 0.175 DIA
0.100 MIN
0.100
0.050
3 - COLLECTOR
0.050
0.050
0.050
0.050
0.050
0.050
45°
2 - BASE
1 - EMITTER

ALL DIMENSIONS ARE IN INCHES UNLESS OTHERWISE SPECIFIED

THE COLLECTOR IS IN ELECTRICAL CONTACT WITH THE CASE.

ALL JEDEC TO-18 DIMENSIONS AND NOTES ARE APPLICABLE.

*absolute maximum ratings at 25°C free-air temperature (unless otherwise noted)

Collector-Base Voltage	.75 v
Collector-Emitter Voltage (See Note 1)	.40 v
Emitter-Base Voltage	7 v
Collector Current	300 ma
Total Device Dissipation at (or below) 25°C Free-Air Temperature (See Note 2)	0.5 w
Total Device Dissipation at (or below) 25°C Case Temperature (See Note 3)	1.5 w
Storage Temperature Range	-65°C to 200°C

*electrical characteristics at 25°C free-air temperature (unless otherwise noted)

PARAMETER	TEST CONDITIONS	MIN	MAX	UNIT
BV_{CBO} Collector-Base Breakdown Voltage	$I_C = 100 \mu a, I_E = 0$	75		v
BV_{CEO} Collector-Emitter Breakdown Voltage	$I_C = 30 ma, I_B = 0, \text{ See Note 4}$	40		v
BV_{EBO} Emitter-Base Breakdown Voltage	$I_E = 100 \mu a, I_C = 0$	7		v
I_{CBO} Collector Cutoff Current	$V_{CB} = 60 v, I_E = 0$		10	na
	$V_{CB} = 60 v, I_E = 0, T_A = 150^\circ C$		10	μa
I_{EBO} Emitter Cutoff Current	$V_{EB} = 5 v, I_C = 0$		10	na
h_{FE} Static Forward Current Transfer Ratio	$V_{CE} = 10 v, I_C = 100 \mu a$	1000		
	$V_{CE} = 10 v, I_C = 10 ma$	4000		
	$V_{CE} = 10 v, I_C = 100 ma, \text{ See Note 4}$	7000	70 000	
	$V_{CE} = 10 v, I_C = 100 ma, T_A = -55^\circ C, \text{ See Note 4}$	1000		
V_{BE} Base-Emitter Voltage	$V_{CE} = 10 v, I_C = 100 ma, \text{ See Note 4}$	0.9	1.8	v
$V_{CE(sat)}$ Collector-Emitter Saturation Voltage	$I_B = 1 ma, I_C = 100 ma, \text{ See Note 4}$		1.6	v
C_{ob} Common-Base Open-Circuit Output Capacitance	$V_{CB} = 10 v, I_E = 0, f = 1 mc$		35	pf

- NOTES: 1. This value applies when the emitter-base diode is open-circuited.
 2. Derate linearly to 175°C free-air temperature at the rate of 3.33 mw/°C.
 3. Derate linearly to 175°C case temperature at the rate of 10.0 mw/°C.
 4. These parameters must be measured using pulse techniques. PW = 300 μ sec, Duty Cycle \leq 2%.

*Indicates JEDEC registered data

TI Microlibrary Books for Creative Circuit Designers

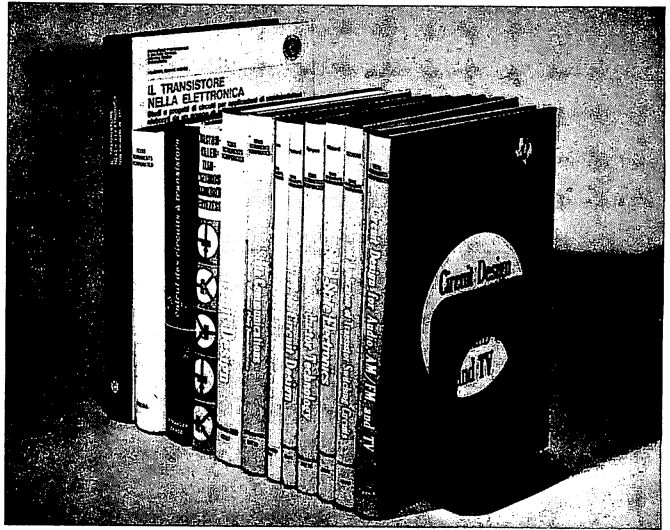

TRANSISTOR CIRCUIT DESIGN

523 Pages • 526 Illustrations • Published January '63 •
Shipping Weight 3-lb 4 oz • \$15.00

FIELD-EFFECT TRANSISTORS • L. J. SEVIN

138 Pages • 137 Illustrations • Published April '65 •
Shipping Weight 1-lb 10-oz • \$10.00

MOSFET IN CIRCUIT DESIGN • ROBERT H. CRAWFORD

136 Pages • 100 Illustrations • Published May '67 •
Shipping Weight 1-lb 10-oz • \$10.00

CIRCUIT DESIGN FOR AUDIO, AM/FM AND TV

352 Pages • 145 Illustrations • Published February '67 •
Shipping Weight 2-lb 8-oz • \$14.50

SILICON SEMICONDUCTOR TECHNOLOGY • W. R. RUNYAN

256 Pages • 301 Illustrations • Published May '65 •
Shipping Weight 2-lb 9-oz • \$16.50

DESIGN AND APPLICATION OF TRANSISTOR SWITCHING CIRCUITS • LOUIS DELHOM

278 Pages • 315 Illustrations • Published January '68 •
Shipping Weight 2-lb • \$14.50

SOLID STATE COMMUNICATIONS

366 Pages • 417 Illustrations • Published April '66 •
Shipping Weight 2-lb 9-oz • \$12.50

SOLID STATE ELECTRONICS • ROBERT G. HIBBERD

170 Pages • 90 Illustrations • Published January '68 •
Shipping Weight 1-lb 12-oz • \$8.95

Terms: F.O.B. destination, bulk rate.

Other than bulk rate,
indicate method of shipment,
add shipping charges.

Outside U.S.: Indicate method of shipment,
add shipping charges.

Send check or money order
(no purchase orders) to:

EXECUTIVE SERVICES DISTRIBUTION
Suite 148
8383 Stemmons Freeway
Dallas, Texas 75247

TYPES 2N2060, 2N2223, 2N2223A DUAL N-P-N PLANAR SILICON TRANSISTORS



TWO TRANSISTORS IN ONE PACKAGE FOR DIFFERENTIAL AMPLIFIER APPLICATIONS

- Medium Power
- High Operating Voltage

*mechanical data

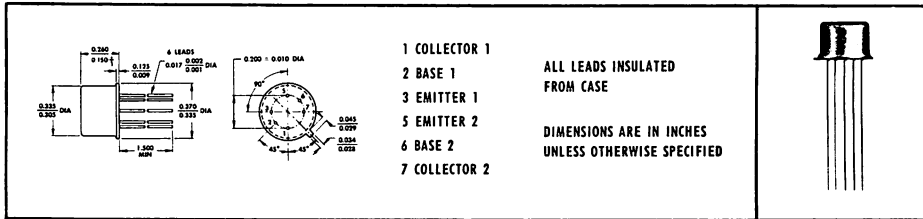

† Applicable to 2N2223 and 2N2223A only. Registered minimum dimension for 2N2060 is 0.140.

*absolute maximum ratings at 25°C free-air temperature (unless otherwise noted)

	2N2060		2N2223 2N2223A		UNIT
	EACH TRIODE	TOTAL DEVICE	EACH TRIODE	TOTAL DEVICE	
Collector-Base Voltage	100		100		v
Collector-Emitter Voltage (See Note 1)	80		80		v
Collector-Emitter Voltage (See Note 2)	60		60		v
Emitter-Base Voltage	7.0		7.0		v
Collector Current	500		500		ma
Total Dissipation at (or below) 25°C Free-Air Temperature (See Note 3)	0.5	0.6	0.5	0.6	w
Total Dissipation at (or below) 25°C Case Temperature (See Notes 4 and 5)	1.5	3.0	1.6	3.0	w
Total Dissipation at 100°C Case Temperature	0.86	1.7	0.91	1.7	w
Operating Collector Junction Temperature	200		200		°C
Storage Temperature Range	-65°C to +200°C				
Lead Temperature 1/16 Inch from Case for 10 Seconds	300°C				

NOTES: 1. This value applies when the base-emitter resistance (R_{BE}) is equal to or less than 10 ohms.

2. This value applies when the base-emitter diode is open-circuited.

3. Derate linearly to 200°C free-air temperature at the rate of 2.86 mw/°C for each triode and 3.43 mw/°C for total device.

4. Derate 2N2060 linearly to 200°C case temperature at the rate of 8.6 mw/°C for each triode and 17.2 mw/°C for total device.

5. Derate 2N2223 and 2N2223A linearly to 200°C case temperature at the rate of 9.1 mw/°C for each triode and 17.2 mw/°C for total device.

6. The terminals of the triode not under test are open-circuited for the measurement of these characteristics.

7. This parameter must be measured using pulse techniques. PW = 300 μsec, Duty Cycle ≤ 1%.

8. The lower of the two h_{FE} readings is taken as h_{FE1} .

9. This parameter is measured in an amplifier with response down 3db at 25 cps and 10 kc and a high frequency rolloff of 6 db/octave.

*Indicates JEDEC registered data.



TEXAS INSTRUMENTS
INCORPORATED
POST OFFICE BOX 5012 • DALLAS, TEXAS 75222

TYPES 2N2060, 2N2223, 2N2223A

DUAL N-P-N PLANAR SILICON TRANSISTORS

electrical characteristics at 25°C free-air temperature (unless otherwise noted)

* individual triode characteristics (see note 6)

PARAMETER	TEST CONDITIONS	2N2060		2N2223 2N2223A		UNIT
		MIN	MAX	MIN	MAX	
V_{CB0} Collector-Base Breakdown Voltage	$I_C = 100 \mu\text{a}, I_E = 0$	100		100		v
V_{CE0} Collector-Emitter Breakdown Voltage	$I_C = 30 \text{ ma}, I_B = 0$ (See Note 7)	60		60		v
V_{CER} Collector-Emitter Breakdown Voltage	$I_C = 100 \text{ ma}, R_{BE} = 10 \Omega$ (See Note 7)	80		80		v
V_{EB0} Emitter-Base Breakdown Voltage	$I_E = 100 \mu\text{a}, I_C = 0$	7.0		7.0		v
I_{CBO} Collector Cutoff Current	$V_{CB} = 80 \text{ v}, I_E = 0$		2		10	na
	$V_{CB} = 80 \text{ v}, I_E = 0, T_A = 150^\circ\text{C}$		10		15	μa
I_{EBO} Emitter Cutoff Current	$V_{EB} = 5 \text{ v}, I_C = 0$		2		10	na
	$V_{CE} = 5 \text{ v}, I_C = 10 \mu\text{a}$	25	75	15		
h_{FE} Static Forward Current Transfer Ratio	$V_{CE} = 5 \text{ v}, I_C = 100 \mu\text{a}$	30	90	25	150	
	$V_{CE} = 5 \text{ v}, I_C = 1 \text{ ma}$	40	120			
	$V_{CE} = 5 \text{ v}, I_C = 10 \text{ ma}$ (See Note 7)	50	150	50	200	
V_{BE} Base-Emitter Voltage	$I_B = 5 \text{ ma}, I_C = 50 \text{ ma}$		0.9		0.9	v
$V_{CE(sat)}$ Collector-Emitter Saturation Voltage	$I_B = 5 \text{ ma}, I_C = 50 \text{ ma}$		1.2		1.2	v
h_{ib} Small-Signal Common-Base Input Impedance	$V_{CB} = 5 \text{ v}, I_C = 1 \text{ ma}, f = 1 \text{ kc}$	20	30	20	30	ohm
h_{rb} Small-Signal Common-Base Reverse Voltage Transfer Ratio	$V_{CB} = 5 \text{ v}, I_C = 1 \text{ ma}, f = 1 \text{ kc}$				3.0×10^{-4}	
h_{ob} Small-Signal Common-Base Output Admittance	$V_{CB} = 5 \text{ v}, I_C = 1 \text{ ma}, f = 1 \text{ kc}$				0.5	μmho
h_{ie} Small-Signal Common-Emitter Input Impedance	$V_{CE} = 5 \text{ v}, I_C = 1 \text{ ma}, f = 1 \text{ kc}$	1000	4000			ohm
h_{fe} Small-Signal Common-Emitter Forward Current Transfer Ratio	$V_{CE} = 5 \text{ v}, I_C = 1 \text{ ma}, f = 1 \text{ kc}$	50	150	40	200	
h_{oe} Small-Signal Common-Emitter Output Admittance	$V_{CE} = 5 \text{ v}, I_C = 1 \text{ ma}, f = 1 \text{ kc}$	4	16			μmho
$ h_{fo} $ Small-Signal Common-Emitter Forward Current Transfer Ratio	$V_{CE} = 10 \text{ v}, I_C = 50 \text{ ma}, f = 20 \text{ mc}$	3.0		2.5		
C_{ob} Common-Base Open-Circuit Output Capacitance	$V_{CB} = 10 \text{ v}, I_E = 0, f = 1 \text{ mc}$		15		15	pf
C_{ib} Common-Base Open-Circuit Input Capacitance	$V_{EB} = 0.5 \text{ v}, I_C = 0, f = 1 \text{ mc}$		85		85	pf

* triode matching characteristics

PARAMETER	TEST CONDITIONS	2N2060		2N2223		2N2223A		UNIT
		MIN	MAX	MIN	MAX	MIN	MAX	
\bar{h}_{FE1} Static Forward Current	$V_{CE} = 5 \text{ v}, I_C = 100 \mu\text{a}$ (See Note 8)	0.9	1.0	0.8	1.0	0.9	1.0	
\bar{h}_{FE2} Gain Balance Ratio	$V_{CE} = 5 \text{ v}, I_C = 1 \text{ ma}$ (See Note 8)	0.9	1.0					
$ V_{BE1} - V_{BE2} $ Base-Emitter-Voltage Differential	$V_{CE} = 5 \text{ v}, I_C = 100 \mu\text{a}$		5		15		5	mv
	$V_{CE} = 5 \text{ v}, I_C = 1 \text{ ma}$		5					mv
$\frac{\Delta(V_{BE1} - V_{BE2})}{\Delta T_A}$ Base-Emitter-Voltage - Differential Temperature Gradient	$V_{CE} = 5 \text{ v}, I_C = 100 \mu\text{a}$, From $T_A = -55^\circ\text{C}$ to $T_A = 125^\circ\text{C}$		10		25		25	$\mu\text{v}/^\circ\text{C}$

operating characteristics at 25°C free-air temperature

* individual triode characteristics (see note 6)

PARAMETER	TEST CONDITIONS	2N2060	UNIT
		MAX	
\bar{NF} Average Noise Figure	$V_{CE} = 10 \text{ v}, I_C = 300 \mu\text{a}, R_o = 510 \Omega$ Noise Bandwidth = 900 cps to 1100 cps	8	db
	$V_{CE} = 10 \text{ v}, I_C = 300 \mu\text{a}, R_o = 1.0 \text{ k}\Omega$ Noise Bandwidth = 15.7 kc (See Note 9)	8	db

*Indicates JEDEC registered data.

TYPES 2N2639, 2N2640, 2N2641, 2N2642, 2N2643 AND 2N2644 DUAL N-P-N PLANAR SILICON TRANSISTORS



TYPES 2N2639, 2N2640, 2N2641, 2N2642, 2N2643 AND 2N2644
BULLETIN NO. DL-5 683321, JANUARY 1963
REVISED MAY 1968

TWO TRANSISTORS IN ONE PACKAGE RECOMMENDED FOR

- Differential Amplifiers
- High-Gain, Low-Noise Audio Amplifiers
- Transducer Signal-Conditioner Amplifiers
- Low-Level Flip-Flops

*mechanical data

ALL LEADS INSULATED FROM CASE

1. COLLECTOR 1
2. BASE 1
3. EMITTER 1
5. EMITTER 2
6. BASE 2
7. COLLECTOR 2

JEDEC TO-5 NOTES 2, 3 AND 4 ARE APPLICABLE.

DIMENSIONS ARE IN INCHES UNLESS OTHERWISE SPECIFIED.

*absolute maximum ratings at 25°C free-air temperature (unless otherwise noted)

	Each Triode	Total Device
Collector-Base Voltage	45 v	
Collector-Emitter Voltage (See Note 1)	45 v	
Emitter-Base Voltage	5 v	
Collector Current	30 ma	
Total Dissipation at (or below) 25°C Free-Air Temperature (See Note 2)	0.3 w	0.6 w
Total Dissipation at (or below) 25°C Case Temperature (See Note 3)	0.6 w	1.2 w
Storage Temperature Range	- 65°C to 200°C	

- NOTES: 1. This value applies when the emitter-base diode is open-circuited.
 2. For each triode derate linearly to 175°C free-air temperature at the rate of 2 mw/°C.
 3. For each triode derate linearly to 175°C case temperature at the rate of 4 mw/°C.

*Indicates JEDEC registered data

TYPES 2N2639, 2N2640, 2N2641, 2N2642, 2N2643 AND 2N2644 DUAL N-P-N PLANAR SILICON TRANSISTORS

electrical characteristics at 25°C free-air temperature (unless otherwise noted)

* individual triode characteristics (see note 4)

PARAMETER	TEST CONDITIONS	2N2639 2N2640 2N2641			2N2642 2N2643 2N2644			UNIT
		MIN	TYP	MAX	MIN	TYP	MAX	
V_{CE0} Collector-Emitter Breakdown Voltage	$I_C = 10 \text{ ma}$, $I_B = 0$, See Note 5	45			45			v
I_{CBO} Collector Cutoff Current	$V_{CB} = 45 \text{ v}$, $I_E = 0$ $V_{CB} = 45 \text{ v}$, $I_E = 0$, $T_A = 150^\circ\text{C}$			10			10	na μa
I_{CEO} Collector Cutoff Current	$V_{CE} = 5 \text{ v}$, $I_B = 0$			10			10	na
I_{EBO} Emitter Cutoff Current	$V_{EB} = 5 \text{ v}$, $I_C = 0$			10			10	na
h_{FE} Static Forward Current Transfer Ratio	$V_{CE} = 5 \text{ v}$, $I_C = 10 \mu\text{a}$ $V_{CE} = 5 \text{ v}$, $I_C = 10 \mu\text{a}$, $T_A = -55^\circ\text{C}$ $V_{CE} = 5 \text{ v}$, $I_C = 100 \mu\text{a}$ $V_{CE} = 5 \text{ v}$, $I_C = 1 \text{ ma}$	50 10 55 65		300	100 20 110 130	150 40 170 200	300	
V_{BE} Base-Emitter Voltage	$I_B = 0.5 \text{ ma}$, $I_C = 10 \text{ ma}$	0.6	0.76	1	0.6	0.76	1	v
$V_{CE(sat)}$ Collector-Emitter Saturation Voltage	$I_B = 0.5 \text{ ma}$, $I_C = 10 \text{ ma}$			1		0.35	1	v
h_{ib} Small-Signal Common-Base Input Impedance	$V_{CB} = 5 \text{ v}$, $I_E = -1 \text{ ma}$, $f = 1 \text{ kc}$	25	26.5	32	25	26.5	32	ohm
h_{rb} Small-Signal Common-Base Reverse Voltage Transfer Ratio	$V_{CB} = 5 \text{ v}$, $I_E = -1 \text{ ma}$, $f = 1 \text{ kc}$			120×10^{-6}	600×10^{-6}		120×10^{-6}	600×10^{-6}
h_{ob} Small-Signal Common-Base Output Admittance	$V_{CB} = 5 \text{ v}$, $I_E = -1 \text{ ma}$, $f = 1 \text{ kc}$		0.1	1		0.1	1	μmho
h_{fe} Small-Signal Common-Emitter Forward Current Transfer Ratio	$V_{CE} = 5 \text{ v}$, $I_C = 1 \text{ ma}$, $f = 1 \text{ kc}$	65		600	130	250	600	
$ h_{fe} $ Small-Signal Common-Emitter Forward Current Transfer Ratio	$V_{CE} = 5 \text{ v}$, $I_C = 1 \text{ ma}$, $f = 20 \text{ mc}$	4	11		4	11		db
C_{ob} Common-Base Open-Circuit Output Capacitance	$V_{CB} = 5 \text{ v}$, $I_E = 0$, $f = 1 \text{ mc}$		5	8		5	8	pf

* triode matching characteristics

PARAMETER	TEST CONDITIONS	2N2639 2N2642		2N2640 2N2643		UNIT
		MIN	MAX	MIN	MAX	
h_{FE1} Static Forward-Current-Gain h_{FE2} Balance Ratio	$V_{CE} = 5 \text{ v}$, $I_C = 10 \mu\text{a}$, See Note 6	0.9	1	0.8	1	
$ V_{BE1} - V_{BE2} $ Base-Emitter-Voltage Differential	$V_{CE} = 5 \text{ v}$, $I_C = 10 \mu\text{a}$		5		10	mv
$\frac{\Delta(V_{BE1} - V_{BE2})}{\Delta T_A}$ Base-Emitter-Voltage-Differential Temperature Gradient	$V_{CE} = 5 \text{ v}$, $I_C = 10 \mu\text{a}$ $\Delta T_A = [25^\circ\text{C} - (-55^\circ\text{C})]$ and $[125^\circ\text{C} - 25^\circ\text{C}]$		10		20	$\mu\text{v}/^\circ\text{C}$

operating characteristics at 25°C free-air temperature

* individual triode characteristics (see note 4)

PARAMETER	TEST CONDITIONS	ALL TYPES		UNIT
		TYP	MAX	
NF Average Noise Figure	$V_{CB} = 5 \text{ v}$, $I_E = -10 \mu\text{a}$, $R_G = 10 \text{ k}\Omega$ Noise Bandwidth 10 cps to 15.7 kc	1.8	4	db

NOTES: 4. The terminals of the triode not under test are open-circuited for the measurement of these characteristics.

5. This parameter must be measured using pulse techniques. PW = 300 μsec , Duty Cycle $\leq 2\%$.

6. The lower of the two h_{FE} readings is taken as h_{FE1} .

*Indicates JEDEC registered data (Typical data excluded.)

TYPES 2N3043, 2N3044, 2N3045, 2N3046, 2N3047, 2N3048 DUAL N-P-N PLANAR SILICON TRANSISTORS



DESIGNED FOR DIFFERENTIAL AMPLIFIERS AND HIGH-GAIN LOW-NOISE
AUDIO AMPLIFIERS

- Electrically Similar to 2N2639-2N2644 Series
- Individual Triodes are Electrically Similar to 2N929, 2N930
- Popular TO-89 Flatpack Facilitates High-Density Packaging
- Welded Metal Construction

TYPES 2N3043 THRU 2N3048
BULLETIN NO. DL-5 634208, AUGUST 1963
REVISED APRIL 1967

mechanical data

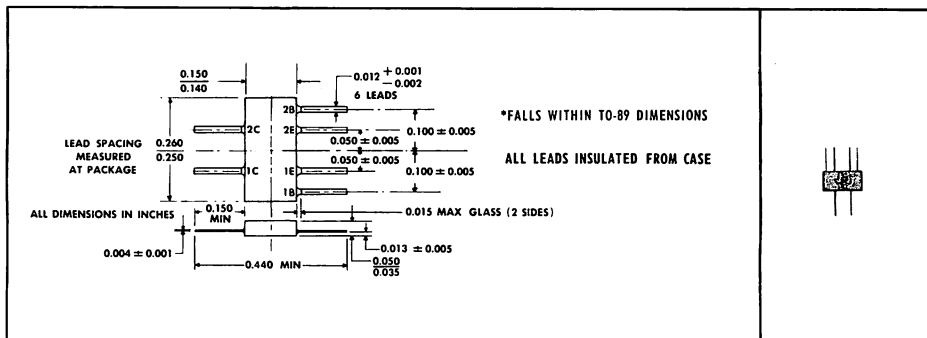

*absolute maximum ratings at 25°C free-air temperature (unless otherwise noted)

	EACH TRIODE	TOTAL DEVICE
Collector-Base Voltage	45 v	
Collector-Emitter Voltage (See Note 1)	45 v	
Emitter-Base Voltage	5 v	
Continuous Collector Current	30 ma	
Continuous Dissipation at (or below) 25°C Free-Air Temperature (See Note 2)	250 mw	350 mw
Continuous Dissipation at (or below) 25°C Case Temperature (See Note 3)	0.7 w	1.4 w
Storage Temperature Range	-65°C to +200°C	
Lead Temperature 1/8 Inch from Case for 10 Seconds	230°C	

NOTES: 1. This value applies when the base-emitter diode is open-circuited.

2. Derate linearly to 175°C free-air temperature at the rate of 1.67 mw/°C for each triode and 2.33 mw/°C for total device.

3. Derate linearly to 175°C case temperature at the rate of 4.67 mw/°C for each triode and 9.33 mw/°C for total device.

*Indicates JEDEC registered data



TYPES 2N3043 THRU 2N3048

DUAL N-P-N PLANAR SILICON TRANSISTORS

electrical characteristics at 25°C free-air temperature (unless otherwise noted)

*individual triode characteristics (see note 4)

PARAMETER	TEST CONDITIONS	2N3043 2N3044 2N3045		2N3046 2N3047 2N3048		UNIT
		MIN	MAX	MIN	MAX	
$V_{(BR)CBO}$ Collector-Emitter Breakdown Voltage	$I_C = 10 \text{ ma}$, $I_B = 0$, See Note 5	45		45		v
$V_{(BR)EBO}$ Emitter-Base Breakdown Voltage	$I_E = 10 \mu\text{a}$, $I_C = 0$	5		5		v
I_{CBO} Collector Cutoff Current	$V_{CB} = 45 \text{ v}$, $I_E = 0$		10		10	na
	$V_{CB} = 45 \text{ v}$, $I_E = 0$, $T_A = 150^\circ\text{C}$		10		10	μa
I_{EBO} Emitter Cutoff Current	$V_{EB} = 4 \text{ v}$, $I_C = 0$		10		10	na
h_{FE} Static Forward Current Transfer Ratio	$V_{CE} = 5 \text{ v}$, $I_C = 10 \mu\text{a}$	100	300	50	200	
	$V_{CE} = 5 \text{ v}$, $I_C = 1 \text{ ma}$	130		65		
V_{BE} Base-Emitter Voltage	$V_{CE} = 5 \text{ v}$, $I_C = 10 \text{ ma}$	0.6	0.8	0.6	0.8	v
$V_{CE(sat)}$ Collector-Emitter Saturation Voltage	$I_B = 0.5 \text{ ma}$, $I_C = 10 \text{ ma}$		1		1	v
h_{ie} Small-Signal Common-Emitter Input Impedance	$V_{CE} = 5 \text{ v}$, $I_C = 1 \text{ ma}$, $f = 1 \text{ kc}$	3.2	19	1.6	13	k Ω
h_{fo} Small-Signal Common-Emitter Forward Current Transfer Ratio	$V_{CE} = 5 \text{ v}$, $I_C = 1 \text{ ma}$, $f = 1 \text{ kc}$	130	600	65	400	
h_{oo} Small-Signal Common-Emitter Output Admittance	$V_{CE} = 5 \text{ v}$, $I_C = 1 \text{ ma}$, $f = 1 \text{ kc}$		100		70	μmho
$ h_{fe} $ Small-Signal Common-Emitter Forward Current Transfer Ratio	$V_{CE} = 5 \text{ v}$, $I_C = 1 \text{ ma}$, $f = 20 \text{ Mc}$	1.5		1.5		
C_{obo} Common-Base Open-Circuit Output Capacitance	$V_{CB} = 5 \text{ v}$, $I_E = 0$, $f = 1 \text{ Mc}$		8		8	pf

*triode matching characteristics

PARAMETER	TEST CONDITIONS	2N3043 2N3046		2N3044 2N3047		UNIT
		MIN	MAX	MIN	MAX	
$\frac{h_{FE1}}{h_{FE2}}$ Static Forward-Current-Gain Balance Ratio	$V_{CE} = 5 \text{ v}$, $I_C = 10 \mu\text{a}$, See Note 6	0.9	1	0.8	1	
$ V_{BE1} - V_{BE2} $ Base-Emitter-Voltage-Differential	$V_{CE} = 5 \text{ v}$, $I_C = 10 \mu\text{a}$		5		10	mv
$ \Delta(V_{BE1} - V_{BE2})_{\Delta T_A} $ Base-Emitter-Voltage-Differential Change With Temperature	$V_{CE} = 5 \text{ v}$, $I_C = 10 \mu\text{a}$, $T_{A(1)} = 25^\circ\text{C}$, $T_{A(2)} = -55^\circ\text{C}$		0.8		1.6	mv
	$V_{CE} = 5 \text{ v}$, $I_C = 10 \mu\text{a}$, $T_{A(1)} = 25^\circ\text{C}$, $T_{A(2)} = 125^\circ\text{C}$		1		2	mv

operating characteristics at 25°C free-air temperature

*individual triode characteristics (see note 4)

PARAMETER	TEST CONDITIONS	ALL TYPES		UNIT
		TYP	MAX	
\overline{NF} Average Noise Figure	$V_{CE} = 5 \text{ v}$, $I_C = 10 \mu\text{a}$, $R_G = 10 \text{ k}\Omega$, Noise Bandwidth = 15.7 kc, See Note 7	2	5	db

NOTES: 4. The terminals of the triode not under test are open-circuited for the measurement of these characteristics.

5. This parameter must be measured using pulse techniques. $PW = 300 \mu\text{sec}$, Duty Cycle $\leq 2\%$.

6. The lower of the two h_{FE} readings is taken as h_{FE1} .

7. Average Noise Figure is measured in an amplifier with low-frequency-response down 3 db at 10 cps.

*Indicates JEDEC registered data

TYPES 2N3049, 2N3050, 2N3051 DUAL P-N-P EPITAXIAL PLANAR SILICON TRANSISTORS



TYPES 2N3049, 2N3050, 2N3051
 BULLETIN NO. DL-S 694230, AUGUST 1963
 REVISED APRIL 1967

DESIGNED FOR DIFFERENTIAL AMPLIFIERS, LOW-NOISE AMPLIFIERS, AND LOW-LEVEL SWITCHING

- Each Triode Electrically Similar to 2N2411 and 2N2412 Transistors
- Popular TO-89 Flatpack Facilitates High-Density Packaging
- Welded Metal Construction

mechanical data

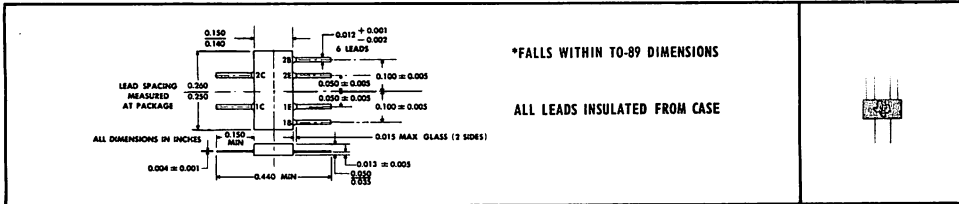

*absolute maximum ratings at 25°C free-air temperature (unless otherwise noted)

	EACH TRIODE	TOTAL DEVICE
Collector-Base Voltage	-25 v	
Collector-Emitter Voltage (See Note 1)	-20 v	
Emitter-Base Voltage	-5 v	
Continuous Collector Current	-100 ma	
Continuous Dissipation at (or below) 25°C Free-Air Temperature (See Note 2)	250 mw	350 mw
Continuous Dissipation at (or below) 25°C Case Temperature (See Note 3)	0.7 w	1.4 w
Storage Temperature Range	-65°C to + 200°C	
Lead Temperature 1/8 Inch from Case for 10 Seconds	230°C	

electrical characteristics at 25°C free-air temperature (unless otherwise noted)

*individual triode characteristics (see note 4)

PARAMETER	TEST CONDITIONS	MIN	MAX	UNIT
$V_{(BR)CEO}$ Collector-Emitter Breakdown Voltage	$I_C = -10$ ma, $I_B = 0$, See Note 5	-20		v
I_{CBO} Collector Cutoff Current	$V_{CB} = -25$ v, $I_E = 0$		-10	na
	$V_{CB} = -25$ v, $I_E = 0$, $T_A = 150^\circ\text{C}$		-10	μa
I_{EBO} Emitter Cutoff Current	$V_{EB} = -5$ v, $I_C = 0$		-10	na
	$V_{CE} = -5$ v, $I_C = -10$ μa	20	120	
h_{FE} Static Forward Current Transfer Ratio	$V_{CE} = -5$ v, $I_C = -100$ μa	30	120	
	$V_{CE} = -5$ v, $I_C = -1$ ma	30	120	
	$V_{CE} = -5$ v, $I_C = -10$ ma, See Note 5	30	120	
	$V_{CE} = -1$ v, $I_C = -10$ ma	20		
V_{BE} Base-Emitter Voltage	$I_B = -1$ ma, $I_C = -10$ ma	-0.7	-0.9	v
$V_{CE(sat)}$ Collector-Emitter Saturation Voltage	$I_B = -1$ ma, $I_C = -10$ ma		-0.2	v
h_{ie} Small-Signal Common-Emitter Input Impedance	$V_{CE} = -5$ v, $I_C = -1$ ma, $f = 1$ kc	0.75	4.5	k Ω
h_{fe} Small-Signal Common-Emitter Forward Current Transfer Ratio	$V_{CE} = -5$ v, $I_C = -1$ ma, $f = 1$ kc	30	130	
h_{oe} Small-Signal Common-Emitter Output Admittance	$V_{CE} = -5$ v, $I_C = -1$ ma, $f = 1$ kc		50	μmho
$ h_{fe} $ Small-Signal Common-Emitter Forward Current Transfer Ratio	$V_{CE} = -5$ v, $I_C = -1$ ma, $f = 20$ Mc	3		
C_{obo} Common-Base Open-Circuit Output Capacitance	$V_{CB} = -5$ v, $I_E = 0$, $f = 1$ Mc		8	pf

NOTES: 1. This value applies when the base-emitter diode is open-circuited.

2. Derate linearly to 175°C free-air temperature at the rate of 1.67 mw/C° for each triode and 2.33 mw/C° for total device.

3. Derate linearly to 175°C case temperature at the rate of 4.67 mw/C° for each triode and 9.33 mw/C° for total device.

4. The terminals of the triode not under test are open-circuited for the measurement of these characteristics.

5. These parameters must be measured using pulse techniques. PW = 300 μsec , Duty Cycle $\leq 2\%$.

*Indicates JEDEC registered data



TYPES 2N3049, 2N3050, 2N3051

DUAL P-N-P EPITAXIAL PLANAR SILICON TRANSISTORS

electrical characteristics at 25°C free-air temperature (unless otherwise noted)

*triode matching characteristics

PARAMETER	TEST CONDITIONS	2N3049		2N3050		UNIT
		MIN	MAX	MIN	MAX	
$\frac{h_{FE1}}{h_{FE2}}$ Static-Forward-Current-Gain Balance Ratio	$V_{CE} = -5 \text{ v}$, $I_C = -100 \mu\text{a}$, See Note 6	0.9	1	0.8	1	
$ V_{BE1} - V_{BE2} $ Base-Emitter-Voltage-Differential	$V_{CE} = -5 \text{ v}$, $I_C = -100 \mu\text{a}$	5		10		mv
$ \Delta(V_{BE1} - V_{BE2})_{\Delta T_A} $ Base-Emitter-Voltage-Differential Change With Temperature	$V_{CE} = -5 \text{ v}$, $I_C = -100 \mu\text{a}$, $T_{A(1)} = 25^\circ\text{C}$, $T_{A(2)} = -55^\circ\text{C}$	0.8		1.6		mv
	$V_{CE} = -5 \text{ v}$, $I_C = -100 \mu\text{a}$, $T_{A(1)} = 25^\circ\text{C}$, $T_{A(2)} = 125^\circ\text{C}$	1		2		mv

NOTE 6: The lower of the two h_{FE} readings is taken as h_{FE1} .

operating characteristics at 25°C free-air temperature

*individual triode characteristics (see note 4)

PARAMETER	TEST CONDITIONS	ALL TYPES		UNIT
		TYP	MAX	
$\overline{\text{NF}}$ Average Noise Figure	$V_{CE} = -5 \text{ v}$, $I_C = -100 \mu\text{a}$, $R_G = 1 \text{ k}\Omega$, Noise Bandwidth = 15.7 kc, See Note 7	2	6	db

NOTE 7: Average Noise Figure is measured in an amplifier with low-frequency-response down 3 db at 10 cps.

switching characteristics at 25°C free-air temperature

*individual triode characteristics (see note 4)

PARAMETER	TEST CONDITIONS†	2N3051		UNIT
		TYP	MAX	
t_d Delay Time	$I_C = -10 \text{ ma}$, $I_{B(1)} = -2.5 \text{ ma}$, $I_{B(2)} = 2 \text{ ma}$, $V_{BE(off)} = +1.2 \text{ v}$, $R_L = 300 \Omega$, See Figure 1	10	15	nsec
t_r Rise Time		15	20	nsec
t_s Storage Time		60	120	nsec
t_f Fall Time		18	30	nsec

†Voltage and current values shown are nominal; exact values vary slightly with transistor parameters.

*PARAMETER MEASUREMENT INFORMATION

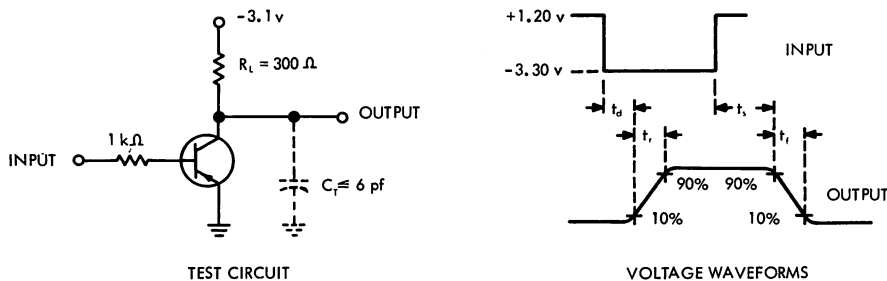

FIGURE 1 — SWITCHING TIMES

NOTES: a. The input waveform has the following characteristics: $t_r \leq 1 \text{ nsec}$, $t_f \leq 1 \text{ nsec}$, $PW \geq 200 \text{ nsec}$, Duty Cycle $\leq 2\%$.

b. Waveforms are monitored on an oscilloscope with the following characteristics: $t_r \leq 1 \text{ nsec}$, $R_{in} \geq 100 \text{ k}\Omega$, $C_{in} \leq 3 \text{ pf}$. The input impedance of the oscilloscope is included in the values shown for R_L , Total Collector Load Resistance, and C_T , Total Collector Shunt Capacitance.

*Indicates JEDEC registered data (typical data excluded).

TYPES 2N3347, 2N3348, 2N3349, 2N3350, 2N3351, 2N3352 DUAL P-N-P EPITAXIAL PLANAR SILICON TRANSISTORS



TYPES 2N3347, 2N3348, 2N3349, 2N3350, 2N3351, 2N3352
BULLETIN NO. DLS-645151, MARCH 1964

TWO P-N-P TRANSISTORS IN ONE PACKAGE

- Each triode electrically similar to 2N2604 and 2N2605 transistors
- Recommended for low-noise, high-gain differential amplifiers
- Designed for complementary use with TI 2N2639 through 2N2644 dual N-P-N transistors

*mechanical data

ALL LEADS INSULATED FROM CASE

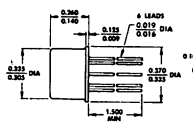
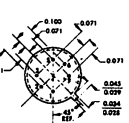
1. COLLECTOR 1
2. BASE 1
3. EMITTER 1
5. EMITTER 2
6. BASE 2
7. COLLECTOR 2

JEDEC TO-5 NOTES 2, 3 AND 4 ARE APPLICABLE.

DIMENSIONS ARE IN INCHES UNLESS OTHERWISE SPECIFIED.



* absolute maximum ratings at 25°C free-air temperature (unless otherwise noted)

	EACH TRIODE	TOTAL DEVICE
Collector-Base Voltage	-60 v	
Collector-Emitter Voltage (See Note 1)	-45 v	
Emitter-Base Voltage	-6 v	
Collector Current	-30 ma	
Total Device Dissipation at (or below) 25°C Free-Air Temperature (See Note 2)	0.3 w	0.6 w
Total Device Dissipation at (or below) 25°C Case Temperature (See Note 3)	0.6 w	1.2 w
Storage Temperature Range	-65°C to +200°C	

- NOTES: 1. This value applies when the base-emitter diode is open-circuited.
2. Derate linearly to 175°C free-air temperature at the rate of 2.0 mw/°C for each triode and 4.0 mw/°C for total device.
3. Derate linearly to 175°C case temperature at the rate of 4.0 mw/°C for each triode and 8.0 mw/°C for total device.

*Indicates JEDEC registered data.

TYPES 2N3347, 2N3348, 2N3349, 2N3350, 2N3351, 2N3352

DUAL P-N-P EPITAXIAL PLANAR SILICON TRANSISTORS

electrical characteristics at 25°C free-air temperature (unless otherwise noted)
 *individual triode characteristics (see note 4)

PARAMETER	TEST CONDITIONS	2N3347 2N3348 2N3349		2N3350 2N3351 2N3352		UNIT
		MIN	MAX	MIN	MAX	
BV_{CBO} Collector-Base Breakdown Voltage	$I_C = -10 \mu A, I_E = 0$	-60		-60		v
BV_{CEO} Collector-Emitter Breakdown Voltage	$I_C = -10 \text{ ma}, I_B = 0$, See Note 5	-45		-45		v
BV_{EBO} Emitter-Base Breakdown Voltage	$I_E = -10 \mu A, I_C = 0$	-6		-6		v
I_{CBO} Collector Cutoff Current	$V_{CB} = -45 \text{ v}, I_E = 0$		-10		-10	na
	$V_{CB} = -45 \text{ v}, I_E = 0, T_A = 150^\circ\text{C}$		-10		-10	μA
I_{EBO} Emitter Cutoff Current	$V_{EB} = -6 \text{ v}, I_C = 0$		-2		-2	na
h_{FE} Static Forward Current Transfer Ratio	$V_{CE} = -5 \text{ v}, I_C = -10 \mu A$	40	300	100	300	
	$V_{CE} = -5 \text{ v}, I_C = -1 \text{ ma}$	60		150		
V_{BE} Base-Emitter Voltage	$V_{CE} = -5 \text{ v}, I_C = -10 \text{ ma}$		-0.9		-0.9	v
$V_{CE(sat)}$ Collector-Emitter Saturation Voltage	$I_B = -0.5 \text{ ma}, I_C = -10 \text{ ma}$		-0.5		-0.5	v
h_{ie} Small-Signal Common-Emitter Input Impedance	$V_{CE} = -5 \text{ v}, I_C = -1 \text{ ma}, f = 1 \text{ kc}$	1.5	20	3.7	20	kohm
h_{fe} Small-Signal Common-Emitter Forward Current Transfer Ratio	$V_{CE} = -5 \text{ v}, I_C = -1 \text{ ma}, f = 1 \text{ kc}$	60	600	150	600	
h_{oe} Small-Signal Common-Emitter Output Admittance	$V_{CE} = -5 \text{ v}, I_C = -1 \text{ ma}, f = 1 \text{ kc}$		100		100	μmho
$ h_{fe} $ Small-Signal Common-Emitter Forward Current Transfer Ratio	$V_{CE} = -5 \text{ v}, I_C = -1 \text{ ma}, f = 30 \text{ Mc}$	2.0	8.0	2.0	8.0	
C_{ob} Common-Base Open-Circuit Output Capacitance	$V_{CB} = -5 \text{ v}, I_E = 0, f = 1 \text{ Mc}$		6		6	pf
C_{ib} Common-Base Open-Circuit Input Capacitance	$V_{EB} = -0.5 \text{ v}, I_C = 0, f = 1 \text{ Mc}$		8		8	pf

*triode matching characteristics

PARAMETER	TEST CONDITIONS	2N3347 2N3350		2N3348 2N3351		2N3349 2N3352		UNIT
		MIN	MAX	MIN	MAX	MIN	MAX	
$\frac{h_{FE1}}{h_{FE2}}$ Static Forward-Current-Gain Balance Ratio	$V_{CE} = -5 \text{ v}, I_C = -10 \mu A$, See Note 6	0.9	1.0	0.8	1.0	0.6	1.0	
$ V_{BE1} - V_{BE2} $ Base-Emitter-Voltage Differential	$V_{CE} = -5 \text{ v}, I_C = -10 \mu A$		5		10		20	mv
$ \Delta(V_{BE1} - V_{BE2})_{T_A} $ Base-Emitter-Voltage-Differential Change With Temperature	$V_{CE} = -5 \text{ v}, I_C = -10 \mu A$, $T_{A(1)} = 25^\circ\text{C}, T_{A(2)} = -55^\circ\text{C}$		0.8		1.6		3.2	mv
	$V_{CE} = -5 \text{ v}, I_C = -10 \mu A$, $T_{A(1)} = 25^\circ\text{C}, T_{A(2)} = 125^\circ\text{C}$		1.0		2.0		4.0	mv

operating characteristics at 25°C free-air temperature
 *individual triode characteristics (see note 4)

PARAMETER	TEST CONDITIONS	ALL TYPES		UNIT
		TYP	MAX	
\overline{NF} Average Noise Figure	$V_{CE} = -5 \text{ v}, I_C = -10 \mu A, R_G = 10 \text{ k}\Omega$, Noise Bandwidth = 15.7 kc, See Note 7	2	4	db

- NOTES: 4. The terminals of the triode not under test are open-circuited for the measurement of these characteristics.
 5. This parameter must be measured using pulse techniques. PW = 300 μsec , Duty Cycle $\leq 2\%$.
 6. The lower of the two h_{FE} readings is taken as h_{FE1} .
 7. Average Noise Figure is measured in an amplifier with low-frequency response down 3 db at 10 cps.

*Indicates JEDEC registered data (typical data excluded).

TYPE 2N3680 DUAL N-P-N PLANAR SILICON TRANSISTOR



TYPE 2N3680
BULLETIN NO. DL-5 686439, FEBRUARY 1965
REVISED MAY 1968

RECOMMENDED FOR DIFFERENTIAL AMPLIFIERS

- Featuring Matching and Tracking Improvements over 2N2453, 2N2642, and 2N2920
- Each Triode Electrically Similar to 2N2484 and 2N930
- h_{FE} at 1 $\mu\alpha$: 80 Min
- Matched from -55°C to 125°C
- $\frac{\Delta(V_{BE1} - V_{BE2})}{\Delta T_A}$: 5 $\mu\text{v}/\text{C}^{\circ}$ Max, Averaged over Temperature Range
- Also Recommended for Low-Level Flip-Flops; High-Gain, Low-Noise Audio Amplifiers; and Transducer Signal-Conditioner Amplifiers

***mechanical data**

ALL LEADS INSULATED FROM CASE

0.380
0.275
0.113
0.007
0.019 DIA
0.019
0.275
0.330 DIA
0.500 MAX

0.100
0.071
0.071
0.045
0.007
0.020
0.020

4 LEADS
0.021
0.021
0.021
0.021

1. COLLECTOR 1
2. BASE 1
3. EMITTER 1
4. EMITTER 2
5. BASE 2
6. BASE 2
7. COLLECTOR 2

JEDEC TO-5 NOTES 2, 3 AND 4 ARE APPLICABLE.
DIMENSIONS ARE IN INCHES UNLESS OTHERWISE SPECIFIED.

***absolute maximum ratings at 25°C free-air temperature (unless otherwise noted)**

	Each Triode	Total Device
Collector-Base Voltage	60 v	
Collector-Emitter Voltage (See Note 1)	50 v	
Emitter-Base Voltage	6 v	
Collector -1—Collector -2 Voltage		± 120 v
Lead-to-Case Voltage		± 120 v
Collector Current	30 ma	
Continuous Dissipation at (or below) 25°C Free-Air Temperature (See Note 2)	0.3 w	0.6 w
Continuous Dissipation at (or below) 25°C Case Temperature (See Note 3)	0.6 w	1.2 w
Storage Temperature Range	-65°C to 200°C	
Lead Temperature $\frac{1}{8}$ Inch From Case For 10 Seconds		300°C

- NOTES: 1. This value applies when the base-emitter diode is open-circuited.
 2. Derate linearly to 175°C free-air temperature at the rate of 2 mw/C° for each triode and 4 mw/C° for total device.
 3. Derate linearly to 175°C case temperature at the rate of 4 mw/C° for each triode and 8 mw/C° for total device.

*Indicates JEDEC registered data

TYPE 2N3680

DUAL N-P-N PLANAR SILICON TRANSISTOR

electrical characteristics at 25°C free-air temperature (unless otherwise noted)

*individual triode characteristics (see note 4)

PARAMETER		TEST CONDITIONS	MIN	MAX	UNIT
$V_{(BR)CBO}$	Collector-Base Breakdown Voltage	$I_C = 10 \mu a, I_E = 0$	60		v
$V_{(BR)CEO}$	Collector-Emitter Breakdown Voltage	$I_C = 10 ma, I_B = 0$, See Note 5	50		v
$V_{(BR)EBO}$	Emitter-Base Breakdown Voltage	$I_E = 10 \mu a, I_C = 0$	6		v
I_{CBO}	Collector Cutoff Current	$V_{CB} = 45 v, I_E = 0$		10	na
		$V_{CB} = 45 v, I_E = 0, T_A = 150^\circ C$		10	μa
I_{CEO}	Collector Cutoff Current	$V_{CE} = 5 v, I_B = 0$		10	na
I_{EBO}	Emitter Cutoff Current	$V_{EB} = 5 v, I_C = 0$		10	na
h_{FE}	Static Forward Current Transfer Ratio	$V_{CE} = 5 v, I_C = 1 \mu a$		80	
		$V_{CE} = 5 v, I_C = 10 \mu a$		150	600
		$V_{CE} = 5 v, I_C = 10 \mu a, T_A = -55^\circ C$		45	
		$V_{CE} = 5 v, I_C = 100 \mu a$		225	
		$V_{CE} = 5 v, I_C = 1 ma$		300	
V_{BE}	Base-Emitter Voltage	$V_{CE} = 5 v, I_C = 10 ma$	0.6	0.8	v
$V_{CE(sat)}$	Collector-Emitter Saturation Voltage	$I_B = 0.5 ma, I_C = 10 ma$		0.7	v
h_{ie}	Small-Signal Common-Emitter Input Impedance	$V_{CE} = 5 v,$ $I_C = 1 ma,$ $f = 1 kc$	7.5	24	k Ω
h_{fe}	Small-Signal Common-Emitter Forward Current Transfer Ratio		300	900	
h_{re}	Small-Signal Common-Emitter Reverse Voltage Transfer Ratio		10×10^{-4}		
h_{oe}	Small-Signal Common-Emitter Output Admittance		45		μmho
$ h_{fo} $	Small-Signal Common-Emitter Forward Current Transfer Ratio	$V_{CE} = 5 v, I_C = 500 \mu a, f = 30 Mc$	2	6	
C_{obo}	Common-Base Open-Circuit Output Capacitance	$V_{CB} = 5 v, I_E = 0, f = 1 Mc$		6	pf
C_{ibo}	Common-Base Open-Circuit Input Capacitance	$V_{EB} = 0.5 v, I_C = 0, f = 1 Mc$		6	pf

*triode matching characteristics

PARAMETER		TEST CONDITIONS	MIN	MAX	UNIT
h_{FE1}	Static Forward-Current-Gain Balance Ratio	$V_{CE} = 5 v, I_C = 10 \mu a$, See Note 6	0.9	1	
h_{FE2}		$V_{CE} = 5 v, I_C = 100 \mu a$, See Note 6, $T_A = -55^\circ C$ to $125^\circ C$	0.85	1	
$ V_{BE1} - V_{BE2} $	Base-Emitter-Voltage Differential	$V_{CE} = 5 v, I_C = 10 \mu a$		3	mv
$ \Delta(V_{BE1} - V_{BE2})_{\Delta T_A} $	Base-Emitter-Voltage-Differential Change With Temperature	$V_{CE} = 5 v, I_C = 10 \mu a, T_{A(1)} = 25^\circ C,$ $T_{A(2)} = -55^\circ C$		400	μv
		$V_{CE} = 5 v, I_C = 10 \mu a, T_{A(1)} = 25^\circ C,$ $T_{A(2)} = 125^\circ C$		500	μv

operating characteristics at 25°C free-air temperature

*individual triode characteristics (see note 4)

PARAMETER		TEST CONDITIONS	MIN	MAX	UNIT
\overline{NF}	Average Noise Figure	$V_{CB} = 5 v, I_E = -10 \mu a, R_G = 10 k\Omega,$ Noise Bandwidth = 15.7 kc, See Note 7		3	db

NOTES: 4. The terminals of the triode not under test are open-circuited for the measurement of these characteristics.

5. This parameter must be measured using pulse techniques. PW = 300 μsec , Duty Cycle $\leq 2\%$.

6. The lower of the two h_{FE} readings is taken as h_{FE1} .

7. Average Noise Figure is measured in an amplifier with low-frequency response down 3 db at 10 cps.

*Indicates JEDEC registered data.

TYPE 2N3680 DUAL N-P-N PLANAR SILICON TRANSISTOR

TYPICAL MATCHING CHARACTERISTICS

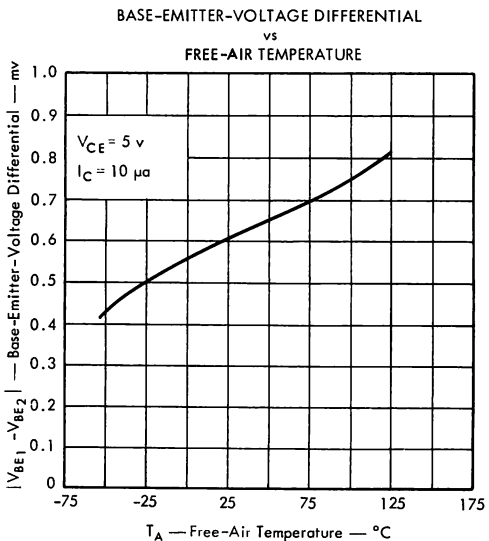
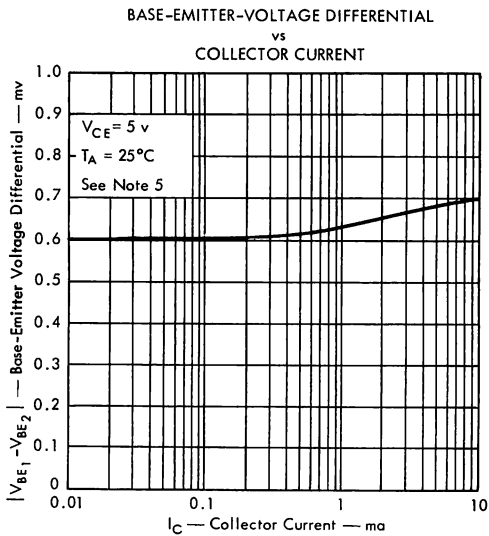

NOTE 5: This parameter must be measured using pulse techniques. PW = 300 μsec, Duty Cycle ≤ 2%.

TYPE 2N3680

DUAL N-P-N PLANAR SILICON TRANSISTOR

TYPICAL MATCHING CHARACTERISTICS

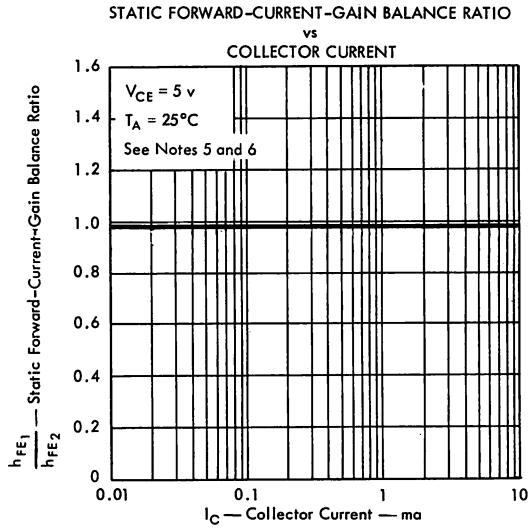

THERMAL INFORMATION

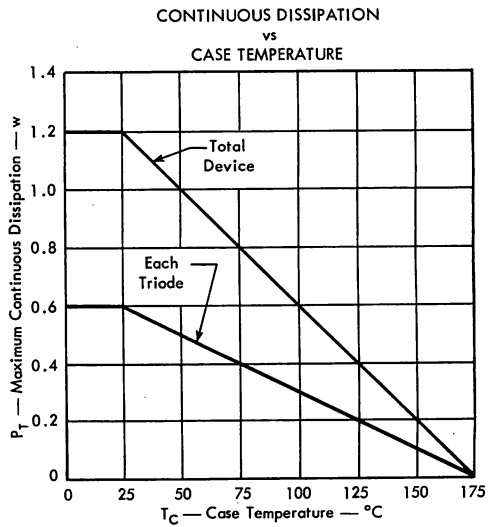
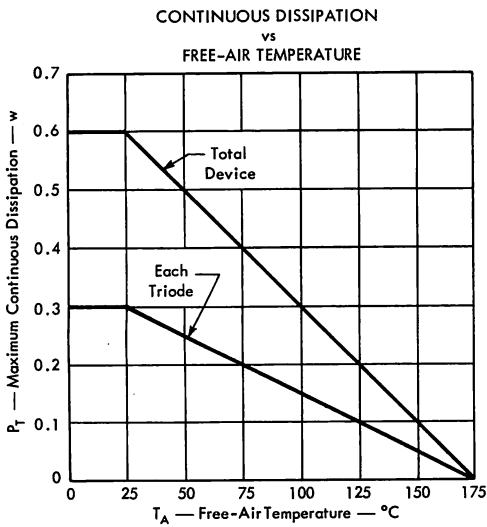

- NOTES: 5. This parameter must be measured using pulse techniques. $PW = 300 \mu\text{sec}$, Duty Cycle $\leq 2\%$.
6. The lower of the two h_{FE} readings is taken as h_{FE1} .

TYPE 2N3838 N-P-N P-N-P DUAL EPITAXIAL PLANAR SILICON TRANSISTOR



TYPE 2N3838
 BULLETIN NO. DA-5 657301, MARCH 1965
 REVISED APRIL 1967

**DESIGNED FOR COMPLEMENTARY MEDIUM-POWER,
HIGH-SPEED SWITCHING AND GENERAL PURPOSE
AMPLIFIER APPLICATIONS**

- Electrically Similar to 2N2222/2N2907
- D-C Beta — Guaranteed from 100 $\mu\alpha$ to 150 ma
- Miniature Flatpack Facilitates High-Density Packaging

mechanical data

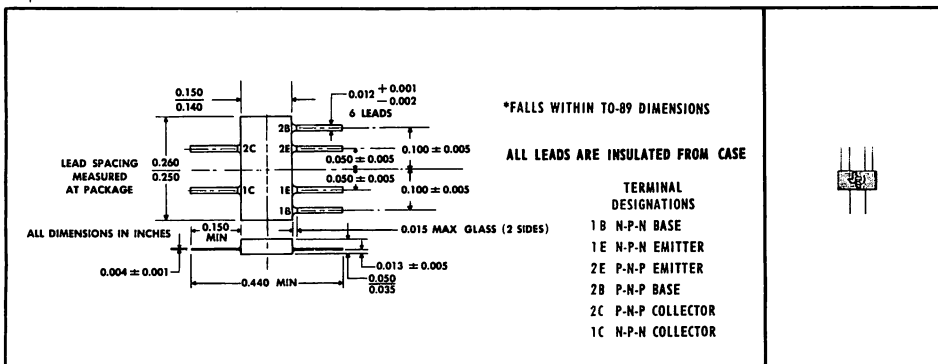

***absolute maximum ratings at 25°C free-air temperature (unless otherwise noted)†**

	EACH TRIODE	TOTAL DEVICE
Collector-Base Voltage	60 v	
Collector-Emitter Voltage (See Note 1)	40 v	
Emitter-Base Voltage	5 v	
Collector-1 — Collector-2 Voltage		± 120 v
Lead-to-Case Voltage		± 120 v
Continuous Collector Current	600 ma	
Continuous Device Dissipation at (or below) 25°C Free-Air Temperature (See Note 2)	250 mw	350 mw
Continuous Device Dissipation at (or below) 25°C Case Temperature (See Note 3)	700 mw	1400 mw
Storage Temperature Range	-65°C to $+200^{\circ}\text{C}$	
Lead Temperature $\frac{1}{8}$ Inch from Case for 10 Seconds		300°C

- NOTES: 1. This value applies between 0 and 10 ma when the base-emitter diode is open-circuited.
 2. Derate linearly to 175°C free-air temperature at the rate of 1.67 mw/C° for each triode and 2.34 mw/C° for total device.
 3. Derate linearly to 175°C case temperature at the rate of 4.67 mw/C° for each triode and 9.34 mw/C° for total device.

†Indicates JEDEC registered data

‡Voltages and currents apply to the N-P-N triode. For the P-N-P triode, the values are the same, but the signs are reversed.

TYPE 2N3838

N-P-N P-N-P DUAL EPITAXIAL PLANAR SILICON TRANSISTOR

electrical characteristics at 25°C free-air temperature (unless otherwise noted)[†]

*individual triode characteristics (see note 4)

PARAMETER		TEST CONDITIONS	MIN	MAX	UNIT
$V_{(BR)CBO}$	Collector-Base Breakdown Voltage	$I_C = 10 \mu A, I_E = 0$	60		v
$V_{(BR)CEO}$	Collector-Emitter Breakdown Voltage	$I_C = 10 \text{ ma}, I_B = 0, \text{ See Note 5}$	40		v
$V_{(BR)EBO}$	Emitter-Base Breakdown Voltage	$I_E = 10 \mu A, I_C = 0$	5		v
I_{CEV}	Collector Cutoff Current	$V_{CE} = 50 \text{ v}, V_{BE} = -0.5 \text{ v}$		10	na
		$V_{CE} = 50 \text{ v}, V_{BE} = -0.5 \text{ v}, T_A = 150^\circ\text{C}$		10	μA
I_{BEV}	Base Cutoff Current	$V_{CE} = 50 \text{ v}, V_{BE} = -0.5 \text{ v}$		-10	na
I_{EBO}	Emitter Cutoff Current	$V_{EB} = 3 \text{ v}, I_C = 0$		10	na
h_{FE}	Static Forward Current Transfer Ratio	$V_{CE} = 1 \text{ v}, I_C = 150 \text{ ma}, \text{ See Note 5}$	50		
		$V_{CE} = 10 \text{ v}, I_C = 100 \mu A$	35		
		$V_{CE} = 10 \text{ v}, I_C = 1 \text{ ma}$	50		
		$V_{CE} = 10 \text{ v}, I_C = 10 \text{ ma}, \text{ See Note 5}$	75		
		$V_{CE} = 10 \text{ v}, I_C = 150 \text{ ma}, \text{ See Note 5}$	100	300	
V_{BE}	Base-Emitter Voltage	$I_B = 15 \text{ ma}, I_C = 150 \text{ ma}, \text{ See Note 5}$	0.85	1.3	v
$V_{CE(sat)}$	Collector-Emitter Saturation Voltage	$I_B = 15 \text{ ma}, I_C = 150 \text{ ma}, \text{ See Note 5}$		0.4	v
h_{io}	Small-Signal Common-Emitter Input Impedance	$V_{CE} = 10 \text{ v},$ $I_C = 1 \text{ ma},$ $f = 1 \text{ kc}$	1.5	9	k Ω
h_{fe}	Small-Signal Forward Current Transfer Ratio		60	300	
h_{oe}	Small-Signal Common-Emitter Output Admittance			50	μmho
$ h_{fe} $	Small-Signal Common-Emitter Forward Current Transfer Ratio	$V_{CE} = 10 \text{ v}, I_C = 20 \text{ ma}, f = 100 \text{ Mc}$	2		
C_{obo}	Common-Base Open-Circuit Output Capacitance	$V_{CB} = 10 \text{ v}, I_E = 0, f = 140 \text{ kc}$		8	pf

operating characteristics at 25°C free-air temperature[†]

*individual triode characteristics (see note 4)

PARAMETER		TEST CONDITIONS [‡]	MIN	MAX	UNIT
t_d	Delay Time	$I_C = 150 \text{ ma}, I_{B(1)} = 15 \text{ ma}, V_{BE(off)} = 0,$ $R_L = 64 \Omega, \text{ See Figure 1}$		10	nsec
t_r	Rise Time			40	nsec
t_s	Storage Time	$I_C = 150 \text{ ma}, I_{B(1)} = -I_{B(2)} = 15 \text{ ma},$ $R_L = 64 \Omega, \text{ See Figure 2}$		250	nsec
t_f	Fall Time			90	nsec
$V_{CEO(NL)}$	Collector-Emitter Nonlatching Voltage [§]	$I_{C(on)} = 600 \text{ ma}, I_{B(on)} = 120 \text{ ma},$ $I_{B(off)} = 0, \text{ See Figure 3}$	40		v
NF	Spot Noise Figure	$V_{CE} = 10 \text{ v}, I_C = 100 \mu A,$ $R_G = 1 \text{ k}\Omega, f = 1 \text{ kc}$		8	db

NOTES: 4. The terminals of the triode not under test are open-circuited for the measurement of these characteristics.

5. These parameters must be measured using pulse techniques. PW=300 μsec , Duty Cycle $\leq 2\%$.

[†]Indicates JEDEC registered data

[‡]Voltages and currents apply to the N-P-N triode. For the P-N-P triode, the values are the same, but the signs are reversed.

[§]Voltages and current values shown are nominal; exact values vary with device parameters.

[§]This characteristic is the highest value of collector supply voltage which may be safely used with a resistive-load switching circuit in which the collector current approaches 600 ma.

TYPE 2N3838

N-P-N P-N-P DUAL EPITAXIAL PLANAR SILICON TRANSISTOR

*PARAMETER MEASUREMENT INFORMATION

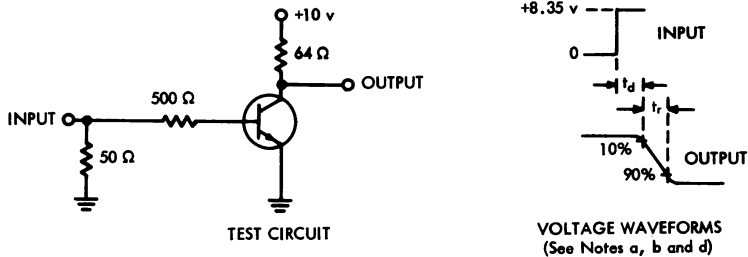

FIGURE 1

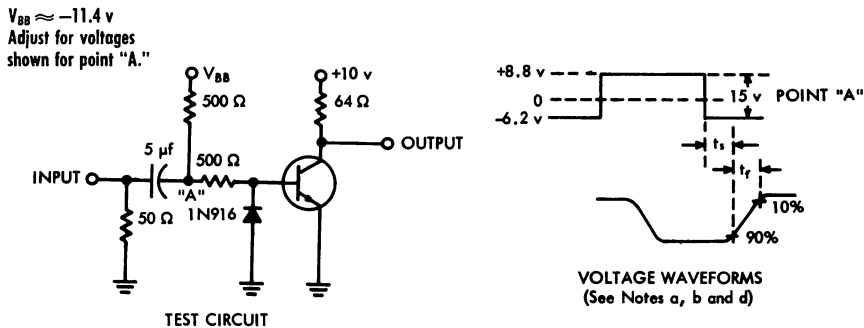

FIGURE 2

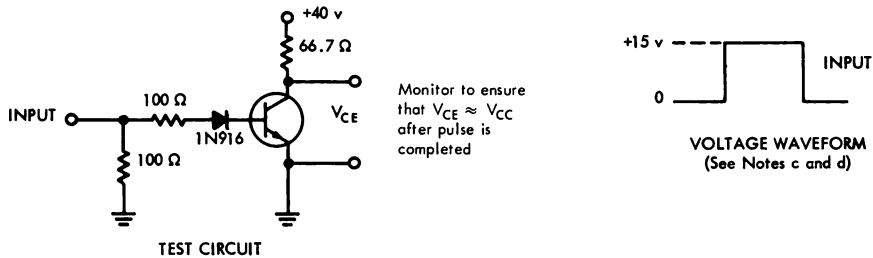

FIGURE 3 — COLLECTOR-EMITTER NONLATCHING VOLTAGE TEST CIRCUIT

- NOTES: a. The input waveforms are supplied by a generator with the following characteristics: for Figure 1, $Z_{out} = 50 \Omega$, $t_r \leq 1$ nsec, $PW \geq 400$ nsec, Duty Cycle $\leq 2\%$; for Figure 2, $Z_{out} = 50 \Omega$, $t_r \leq 10$ nsec, $PW = 10 \mu\text{sec}$, Duty Cycle $\leq 2\%$.
- b. The waveforms are monitored on an oscilloscope with the following characteristics: for Figure 1, $t_r \leq 1$ nsec, $R_{in} \geq 100$ k Ω , $C_{in} \leq 5$ pf; for Figure 2, $t_r \leq 5$ nsec, $R_{in} \geq 100$ k Ω , $C_{in} \leq 12$ pf.
- c. The input waveform in Figure 3 has the following characteristics: $PW \leq 10 \mu\text{sec}$, Duty Cycle $\leq 2\%$.
- d. The signs and polarity symbols shown are for the N-P-N triode; the signs and polarity symbols are reversed for the P-N-P triode.

*Indicates JEDEC registered data.

AUTHORIZED DISTRIBUTORS

FOR TEXAS INSTRUMENTS COMPONENTS GROUP

ALABAMA

ACK SEMICONDUCTORS INC.
3101 Fourth Ave. South/(205) FA 2-0588
Birmingham, Alabama 35233

ELECTRONIC WHOLESALERS, INC.
2310 Bob Wallace Avenue, S.W.
(205) 534-2461
Huntsville, Alabama 35805

ARIZONA

KIERULFF ELECTRONICS, INC.
2633 East Buckeye Road
(602) 773-7331
Phoenix, Arizona 85034

R. V. WEATHERFORD COMPANY
1917 North 25 Drive/(602) 272-7144
Carson Industrial Center
Phoenix, Arizona

CALIFORNIA

CALIFORNIA ELECTRONICS SUPPLY, INC.
1911 Armacost Avenue/(213) TR 9-0760
West Los Angeles, California 90025

KIERULFF ELECTRONICS, INC.
3969 E. Bayshore/(415) 968-6292
Palo Alto, California 94303

MILO OF CALIFORNIA
2060 India St./(714) BE 2-8951
San Diego, California 92101

RADIO PRODUCTS SALES, INC.
1501 S. Hill St./(213) RI 8-1271
Los Angeles, California 90015

R. V. WEATHERFORD COMPANY
1651 S. State College Blvd.
(714) KI 7-7521
Anaheim, California 92805

6921 San Fernando Rd./(213) VI 9-3451
Glendale, California 91201
3240 Hillview Drive
Stanford Industrial Park
(415) DA 1-5373
Palo Alto, California 94304

TI SUPPLY COMPANY
1651 Tenth Street/(213) 393-6731
Santa Monica, California 90404

COLORADO

TI SUPPLY COMPANY
2186 S. Holly/(303) 757-7671
Denver, Colorado 80222

FLORIDA

ELECTRONIC WHOLESALERS, INC.
345 Graham Ave./(305) 841-1550
Orlando, Florida 32814

9390 N. W. 27th Ave./(305) OX 6-1620
Miami, Florida 33147

ILLINOIS

ALLIED ELECTRONICS CORPORATION
100 N. Western Ave./(312) TA 9-9100
Chicago, Illinois 60680

MERQUIP ELECTRONICS, INC.
7701 No. Austin Ave./(312) 965-7500
Skokie, Illinois 60076

NEWARK ELECTRONICS CORP.
500 N. Pulaski Road/(312) 638-4411
Chicago, Illinois 60624

TI SUPPLY COMPANY
7135 N. Barry Avenue/(312) 296-7187
Des Plaines, Illinois 60018

INDIANA

ESCO ELECTRONICS INC.
2442 N. Shadeland Ave./(317) 357-8791
Indianapolis, Indiana 46219

RADIO DISTRIBUTING COMPANY
814 North Senate Avenue
(317) 637-5571
Indianapolis, Indiana 46204

IOWA

DEECO, INC.
618 First St., N. W./(319) EM 5-7551
Cedar Rapids, Iowa 72405

LOUISIANA

ELECTRONIC PRODUCTS CORPORATION
3622 Toulouse St./(504) HU 6-3777
New Orleans, Louisiana 70119

MARYLAND

ELECTRONIC WHOLESALERS, INC.
3200 Wilkens Ave./(301) 646-3600
Baltimore, Maryland 21223

MILGRAY/WASHINGTON
5405 Lafayette Place/(202) 864-1111
Hyattsville, Maryland 20781

MASSACHUSETTS

DEMAMBRO ELECTRONICS
1095 Commonwealth Ave.
(617) 787-1200
Boston, Massachusetts 02215

TI SUPPLY COMPANY
480 Neponset Road/(617) 828-5020
Canton, Massachusetts 02021

LAFAYETTE INDUSTRIAL ELECTRONICS
1400 Worcester Rd./(617) 969-6100
Natick, Massachusetts 01760

MILGRAY/NEW ENGLAND INC.
75 Terrace Hall Avenue/(617) 272-6800
Burlington, Massachusetts 02021

MICHIGAN

NEWARK-DETROIT ELECTRONICS, INC.
20700 Hubbell Ave./(313) 548-0250
Detroit, Michigan 48237

NEWARK-INDUSTRIAL
ELECTRONICS CORP.
2114 So. Division/(616) CH 1-5695
Grand Rapids, Michigan 49507

MINNESOTA

THIRD ELECTRONIC SUPPLY CO.
112 Third Avenue N/(612) FE 2-1325
Minneapolis, Minnesota 55401

MISSOURI

TI SUPPLY COMPANY
2916 Holmes Street/(816) 753-4750
Kansas City, Missouri 64109

ELECTRONIC COMPONENTS FOR
INDUSTRY
2605 South Hanley Rd./(314) MI 7-5505
St. Louis, Missouri 63144

NEW JERSEY

GENERAL RADIO SUPPLY COMPANY, INC.
600 Penn St./(609) WO 4-8560
Camden, New Jersey 08102

TI SUPPLY COMPANY
301 Central Ave./(201) 382-6400
Clark, N. J. 07066

NEW MEXICO

KIERULFF ELECTRONICS, INC.
2524 Baylor Dr. S.E./(505) 247-1055
Albuquerque, New Mexico 87108

NEW YORK

GENESEE RADIO & PARTS CO., INC.
2550 Delaware Ave./(716) TR 3-9661
Buffalo, New York 14216

LAFAYETTE INDUSTRIAL ELECTRONICS
165-08 Liberty Ave./(212) 658-5050
Jamaica, New York 11431

MILGRAY/NEW YORK
160 Varick St./(212) YU 9-1600
New York, New York 10013

ROCHESTER RADIO SUPPLY CO., INC.
140 W. Main St./(716) 454-7800
Rochester, New York 14614

TI SUPPLY COMPANY
4 Nevada Dr./(516) 488-3300
New Hyde Park, L. I., N. Y. 11040

NORTH CAROLINA

ELECTRONIC WHOLESALERS, INC.
938 Burke St./(919) PA 5-8711
Winston-Salem, North Carolina 27101

OHIO

ESCO ELECTRONICS INC.
3130 Valleywood Drive/(513) 298-0191
Dayton, Ohio 45429

MILGRAY/CLEVELAND
1821 East 40th Street/(216) 881-8800
Cleveland, Ohio 44102

NEWARK-HERRLINGER
ELECTRONICS CORP.
112 E. Liberty St./(513) GA 1-5282
Cincinnati, Ohio 45210

W. M. PATTISON SUPPLY CO.
4550 Willow Parkway/(216) 441-3000
Cleveland, Ohio 44125

SREPCO ELECTRONICS, INC.
314 Leo Street/(513) BA 4-3871
Dayton, Ohio 45404

OKLAHOMA

TI SUPPLY COMPANY
12151 E. Skelly Dr./(918) 437-4555
Tulsa, Oklahoma 74110

OREGON

ALMAC STROUM ELECTRONICS
CORPORATION
8888 S.W. Canyon Road/(503) 292-3534
Portland, Oregon 97225

PENNSYLVANIA

MILGRAY/DELAWARE VALLEY INC.
2532 N. Broad St./(215) BA 8-2000
Philadelphia, Penn. 19107

RPC ELECTRONICS
620 Alpha Dr./(412) 782-3770
RIDC Park
Pittsburgh, Pennsylvania 15238

TEXAS

TI SUPPLY COMPANY
6000 Denton Drive/(214) FL 7-6121
Dallas, Texas 75235

5240 Elm Street/(713) MO 6-2175
Houston, Texas 77036

HARRISON EQUIPMENT COMPANY, INC.
1422 San Jacinto St./(713) CA 4-9131
Houston, Texas 77001

MIDLAND SPECIALTY COMPANY
2235 Wyoming Ave./(915) KE 3-9555
El Paso, Texas 79903

UTAH

STANDARD SUPPLY COMPANY
225 E. Sixth South St./(801) EL 5-2971
Salt Lake City, Utah 84110

WASHINGTON

ALMAC-STROUM ELECTRONICS
5811 Sixth Ave. So./(206) 763-2300
Seattle, Washington 98108

WASHINGTON, D.C.

ELECTRONIC WHOLESALERS, INC.
2345 Sherman Ave., N. W.
(202) HU 3-5200
Washington, D.C. 20001

CANADA

CANADIAN ELECTRONICS LTD.
Calgary, Alberta
Edmonton, Alberta
Lethbridge, Alberta
Medicine Hat, Alberta
Vancouver, B. C.

CESCO ELECTRONICS LTD.
Downsview, Quebec
Quebec, Quebec
Ottawa, Ontario
Toronto, Ontario

TI SUPPLY COMPANY
Dorval, Quebec

WELLINGTON, New Zealand
W. G. LEATHAM LTD.

AUSTRALIAN TI DISTRIBUTOR

MELBOURNE, Australia
RADIO PARTS PTY. LTD.
PERTH, Australia
PRECISION ELECTRONICS
BRISBANE, Australia
DOUGLAS ELECTRONICS

EUROPEAN TI DISTRIBUTORS

BRUSSELS IV, Belgium
S.A. AVI-ELEC N.V.

COPENHAGEN V, Denmark
TEXAS INSTRUMENTS A/S

HELSINKI, Finland
OY CHESTER AB

HAMBURG, West Germany
FIRMA ALFRED NEVE, ENATECHNIK

STUTTGART, WEST GERMANY
TI SUPPLY CO.

OSLO, Norway
MORGENSTIERNE & CO.

STOCKHOLM, Sweden
AB GOSTA BACKSTROM

ZURICH 32, Switzerland
FABRIMEX AG ZURICH

PARIS, FRANCE
TI SUPPLY CO.

MILANO, ITALY
TI SUPPLY CO.

MANCHESTER, ENGLAND
TI SUPPLY CO.

TYPES 2N4854, 2N4855 N-P-N, P-N-P, DUAL EPITAXIAL PLANAR SILICON TRANSISTORS



TYPES 2N4854, 2N4855
BULLETIN NO. DL-S 669019, OCTOBER 1966

DESIGNED FOR COMPLEMENTARY MEDIUM-POWER, HIGH-SPEED SWITCHING AND GENERAL PURPOSE AMPLIFIER APPLICATIONS

- 2N4854 Electrically Similar to 2N2222/2N2907
- 2N4855 Electrically Similar to 2N2221/2N2906
- h_{FE} — Guaranteed from 100 μ A to 300 mA
- Low-Profile Case

*mechanical data

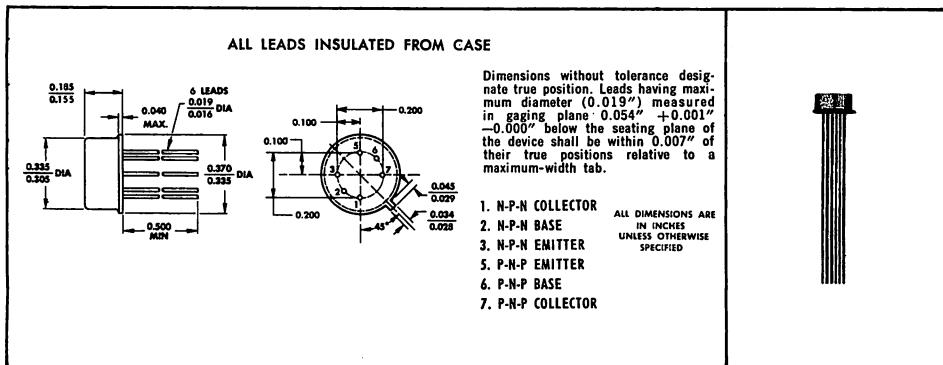

*absolute maximum ratings at 25°C free-air temperature (unless otherwise noted)†

	EACH TRIODE	TOTAL DEVICE
Collector-Base Voltage	60 V	
Collector-Emitter Voltage (See Note 1)	40 V	
Emitter-Base Voltage	5 V	
Collector-1 — Collector-2 Voltage		± 120 V
Lead-to-Case Voltage		± 120 V
Continuous Collector Current	600 mA	
Continuous Device Dissipation at (or below) 25°C Free-Air Temperature (See Note 2)	300 mW	600 mW
Continuous Device Dissipation at (or below) 25°C Case Temperature (See Note 3)	1 W	2 W
Storage Temperature Range	-65°C to 200°C	
Lead Temperature $\frac{1}{16}$ Inch from Case for 10 Seconds	300°C	

NOTES: 1. This value applies between 0 and 600 mA collector current when the base-emitter diode is open-circuited. 40 V and 600 mA collector current may be simultaneously applied provided the time of application is 10 μ s or less and the duty cycle is 2% or less.

2. Derate linearly to 175°C free-air temperature at the rate of 2 mW/deg for each triode and 4 mW/deg for total device.

3. Derate linearly to 175°C case temperature at the rate of 6.67 mW/deg for each triode and 13.33 mW/deg for total device.

*Indicates JEDEC registered data

† Voltages and currents apply to the N-P-N triode. For the P-N-P triode the values are the same, but the signs are reversed.



TEXAS INSTRUMENTS
INCORPORATED
POST OFFICE BOX 5012 • DALLAS, TEXAS 75222

TYPES 2N4854, 2N4855

N-P-N, P-N-P, DUAL EPITAXIAL PLANAR SILICON TRANSISTORS

electrical characteristics at 25°C free-air temperature (unless otherwise noted)†

*individual triode characteristics (see note 4)

PARAMETER	TEST CONDITIONS	2N4854		2N4855		UNIT
		MIN	MAX	MIN	MAX	
$V_{(BR)CBO}$ Collector-Base Breakdown Voltage	$I_C = 10 \mu A, I_E = 0$	60		60		V
$V_{(BR)CEO}$ Collector-Emitter Breakdown Voltage	$I_C = 10 \text{ mA}, I_B = 0, \text{ See Note 5}$	40		40		V
$V_{(BR)EBO}$ Emitter-Base Breakdown Voltage	$I_E = 10 \mu A, I_C = 0$	5		5		V
I_{CBO} Collector Cutoff Current	$V_{CB} = 50 \text{ V}, I_E = 0$		10		10	nA
	$V_{CB} = 50 \text{ V}, I_E = 0, T_A = 150^\circ C$		10		10	μA
I_{EBO} Emitter Cutoff Current	$V_{EB} = 3 \text{ V}, I_C = 0$		10		10	nA
	$V_{CE} = 1 \text{ V}, I_C = 150 \text{ mA}, \text{ See Note 5}$	50		20		
h_{FE} Static Forward Current Transfer Ratio	$V_{CE} = 10 \text{ V}, I_C = 100 \mu A$	35		20		
	$V_{CE} = 10 \text{ V}, I_C = 1 \text{ mA}$	50		25		
	$V_{CE} = 10 \text{ V}, I_C = 10 \text{ mA}, \text{ See Note 5}$	75		35		
	$V_{CE} = 10 \text{ V}, I_C = 150 \text{ mA}, \text{ See Note 5}$	100	300	40	120	
	$V_{CE} = 10 \text{ V}, I_C = 300 \text{ mA}, \text{ See Note 5}$	35		20		
V_{BE} Base-Emitter Voltage	$I_B = 15 \text{ mA}, I_C = 150 \text{ mA}, \text{ See Note 5}$	0.75	1.2	0.75	1.2	V
$V_{CE(sat)}$ Collector-Emitter Saturation Voltage	$I_B = 15 \text{ mA}, I_C = 150 \text{ mA}, \text{ See Note 5}$		0.4		0.4	V
h_{ie} Small-Signal Common-Emitter Input Impedance	$V_{CE} = 10 \text{ V},$ $I_C = 1 \text{ mA},$	1.5	9	0.75	4.5	k Ω
h_{fe} Small-Signal Common-Emitter Forward Current Transfer Ratio	$f = 1 \text{ kHz}$	60	300	30	150	
h_{oe} Small-Signal Common-Emitter Output Admittance	$f = 1 \text{ kHz}$		50		25	μmho
$ h_{fo} $ Small-Signal Common-Emitter Forward Current Transfer Ratio	$V_{CE} = 10 \text{ V}, I_C = 20 \text{ mA}, f = 100 \text{ MHz}$	2		2		
C_{cb} Collector-Base Capacitance	$V_{CB} = 10 \text{ V}, I_E = 0, f = 1 \text{ MHz}, \text{ See Note 6}$		8		8	pF

operating characteristics at 25°C free-air temperature†

*individual triode characteristics (see note 4)

PARAMETER	TEST CONDITIONS	MIN	MAX	UNIT
t_d Delay Time	$I_C = 150 \text{ mA}, I_{B(1)} = 15 \text{ mA}, V_{BE(off)} = -0.5 \text{ V},$ $R_L = 200 \Omega, \text{ See Note 7 and Figure 1}$		20	ns
t_r Rise Time	$I_C = 150 \text{ mA}, I_{B(1)} = 15 \text{ mA}, I_{B(2)} = -15 \text{ mA},$ $R_L = 200 \Omega, \text{ See Note 7 and Figure 2}$		40	ns
t_s Storage Time	$V_{CE} = 10 \text{ V}, I_C = 100 \mu A, R_E = 1 \text{ k}\Omega,$ $f = 1 \text{ kHz}$		280	ns
t_f Fall Time			70	ns
NF Spot Noise Figure			8	dB

NOTES: 4. The terminals of the triode not under test are open-circuited for the measurement of these characteristics.

5. These parameters must be measured using pulse techniques. $t_p = 300 \mu s$, duty cycle $\leq 2\%$.

6. Collector-Base Capacitance is measured using three-terminal measurement techniques with the emitter and case guarded.

7. Voltages and current values shown are nominal; exact values vary with device parameters.

*Indicates JEDEC registered data

†Voltages and currents apply to the N-P-N triode. For the P-N-P triode the values are the same, but the signs are reversed.

TYPES 2N4854, 2N4855 N-P-N, P-N-P, DUAL EPITAXIAL PLANAR SILICON TRANSISTORS

*PARAMETER MEASUREMENT INFORMATION

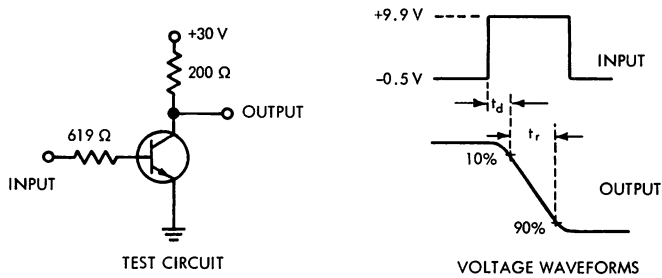

FIGURE 1 – DELAY AND RISE TIMES

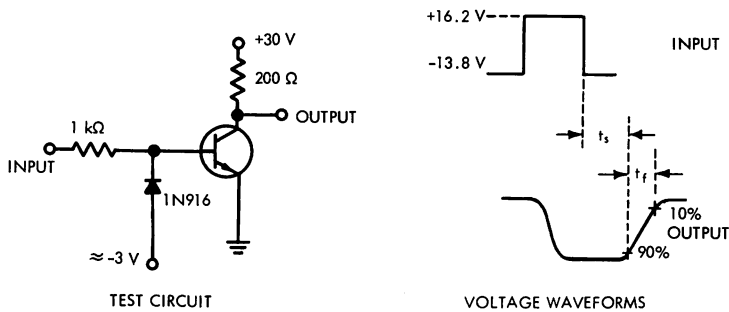

FIGURE 2 – STORAGE AND FALL TIMES

NOTES: a. The input waveforms have the following characteristics: For figure 1, $t_r \leq 2$ ns, $t_p = 200$ ns, duty cycle $\leq 2\%$; for figure 2, $t_f \leq 5$ ns, $t_p = 10$ μ s, duty cycle $\leq 2\%$.

b. All waveforms are monitored on an oscilloscope with the following characteristics: $t_r \leq 5$ ns, $R_{in} \geq 100$ k Ω , $C_{in} \leq 12$ pF.

c. The signs and polarity symbols shown are for the N-P-N triode; for the P-N-P triode the signs and polarity symbols are reversed.

*Indicates JEDEC registered data

TI World-Wide Sales Offices

ALABAMA

Sahara Office Park Bldg., Suite 111
3313 Memorial Parkway, S.W.
Huntsville, Alabama 35801
205-881-4061

ARIZONA

2535 W. Camelback Rd., Suite 1D
Phoenix, Arizona 85017
602-279-5531

CALIFORNIA

1800 North Argyle Ave.
Hollywood, California 90028
213-466-7251

5005 West Century Blvd., Suite 208
Inglewood, California 90301
213-673-3943

230 California Ave., Suite 201
Palo Alto, California 94306
415-326-6770

1505 East 17th St., Suite 201
Santa Ana, California 92701
714-547-6506

4185 Adams Ave.
San Diego, California 92116
714-284-1181

COLORADO

2186 South Holly St., Suite 204
Denver, Colorado 80222
303-757-8548

CONNECTICUT

300 Amity Road
Woodbridge, Connecticut 06525
203-389-4521

FLORIDA

618 East South St., Suite 114
Orlando, Florida 32801
305-422-9894

ILLINOIS

Suite 205, Executive Towers
5901 N. Cicero Ave.
Chicago, Illinois 60646
312-286-1000

MASSACHUSETTS

60 Hickory Drive
Waltham, Mass. 02154
617-891-8450

MICHIGAN

Suite 706 West, Northland Towers Bldg.
15565 Northland Dr.
Southfield, Michigan 48075
313-357-1703

MINNESOTA

7615 Metro Blvd.
Suite 202, U.C.L.I. Bldg.
Edina, Minn. 55424
612-941-4384

NEW JERSEY

U.S. Highway #22
P.O. Box 366
Union, New Jersey 07083
201-687-7200

NEW YORK

P. O. Box 87, 2209 E. Main
Endicott, New York 13760
607-785-9987

4 Nevada Drive
New Hyde Park, N. Y. 11040
516-488-9894

131 Fulton Ave., Apt. J-2
Poughkeepsie, New York 12603
914-471-6095

6563 Ridings Rd.
Syracuse, New York 13206
315-463-9291

OHIO

22035 Chagrin Blvd.
Cleveland, Ohio 44122
216-751-2600

Suite 205, Paul Welch Bldg.
3300 South Dixie Dr.
Dayton, Ohio 45439
513-298-7513

PENNSYLVANIA

Benjamin Fox Pavilion
Suite 424, Foxcroft Square
Jenkintown, Pa. 19046
215-885-3454

TEXAS

MS80 — P.O. Box 5012
Dallas, Texas 75222
214-238-4861

3609 Buffalo Speedway
Houston, Texas 77006
713-526-3268

WASHINGTON

5801 Sixth Ave. S.
Seattle, Washington 98108
206-762-4240

WASHINGTON, D.C.

1875 Connecticut Ave., N.W., Suite 913
Washington, D.C. 20009
202-234-9320

CANADA

Geophysical Service Incorporated
280 Centre Str. East
Richmond Hills
Ontario, Canada
925-1035

663 Orly Avenue
Dorval
Quebec, Canada
631-6010

EUROPE

Texas Instruments Limited
Manton Lane
Bedford, England

Texas Instruments France S. A.
Boite Postale 5
Villeneuve-Loubet (A.M.), France

11 rue de Madrid
Paris 8°, France

Texas Instruments Holland N.V.
Semiconductor Division
Enschedeestraat 19
Hengelo (Ov), Holland

Texas Instruments Italia S.p.A.
Via Colautti 1
Milan, Italy

Texas Instruments Incorporated
118 Rue du Rhone
1204 Geneva, Switzerland

Texas Instruments Sweden A.B.
Timmermangatan 34, Box 17116
Stockholm 17, Sweden

Texas Instruments Deutschland GmbH
Hildesheimerstr. 19
3 Hannover, W. Germany

Texas Instruments Deutschland GmbH
Wolframstrasse 26
7 Stuttgart
West Germany

Texas Instruments Deutschland GmbH
Clemensstrasse 30
8 Munich 23
West Germany

Texas Instruments Deutschland GmbH
Keplerstrasse 33
805 Freising-Lerchenfeld
West Germany

Texas Instruments Deutschland GmbH
Koenigsbacherstrasse 22
6 Frankfurt, West Germany

MEXICO

Texas Instrumentos de Mexico S.A.
Poniente 116 #489
Col. Ind. Vallejo
Mexico 15, D.F.

ARGENTINA

Texas Instruments Argentina S.A.I.C.F.
(P. O. Box 2296 — Correo Central)
Ruta Panamericana Km. 13, 5
Don Torcuato
Buenos Aires, Argentina

BRAZIL

Texas Instrumentos Electronicos
do Brazil Ltda.
Rua Cesario Alvim 770
Caixa Postal 30.103
Sao Paulo 6, Brazil

AUSTRALIA

Texas Instruments Australia Ltd.
Box 63, Oldham Road
Elizabeth, South Australia

Texas Instruments Australia Ltd.
Room 5, Rural Bank Bldg.
Burwood, N.S.W., Australia

JAPAN

Texas Instruments Asia Limited
404 T.B.R. Building
No. 59, 2-chome, Nagata-cho
Chiyoda-du, Tokyo, Japan

TYPES TIS68, TIS69, TIS70 N-CHANNEL EPITAXIAL PLANAR SILICON FIELD-EFFECT TRANSISTORS



TYPES TIS68, TIS69, TIS70
BULLETIN NO. DLS-679669, MARCH 1967

SILECT† FIELD-EFFECT TRANSISTORS SUPPLIED AS MATCHED PAIRS

- High $|y_{fs}|/C_{iss}$ Ratio (High-Frequency Figure-of-Merit)
- Low Input Capacitance, C_{iss} . . . 8 pF Max
- Low Gate Reverse Current Differential . . . 10 nA Max at $T_A = 100^\circ\text{C}$
- Recommended for Low-Cost, Low-Level D-C Amplifiers, Sample-Hold Circuits, and Series-Shunt Choppers

mechanical data

Each TIS68, TIS69, or TIS70 comprises a matched pair of transistors. A clip is supplied with each transistor pair. These transistors are encapsulated in a plastic compound specifically designed for this purpose, using a highly mechanized process‡ developed by Texas Instruments. The case will withstand soldering temperatures without deformation. These devices exhibit stable characteristics under high-humidity conditions and are capable of meeting MIL-STD-202C method 106B. The transistors are insensitive to light.

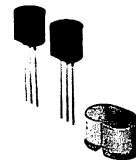
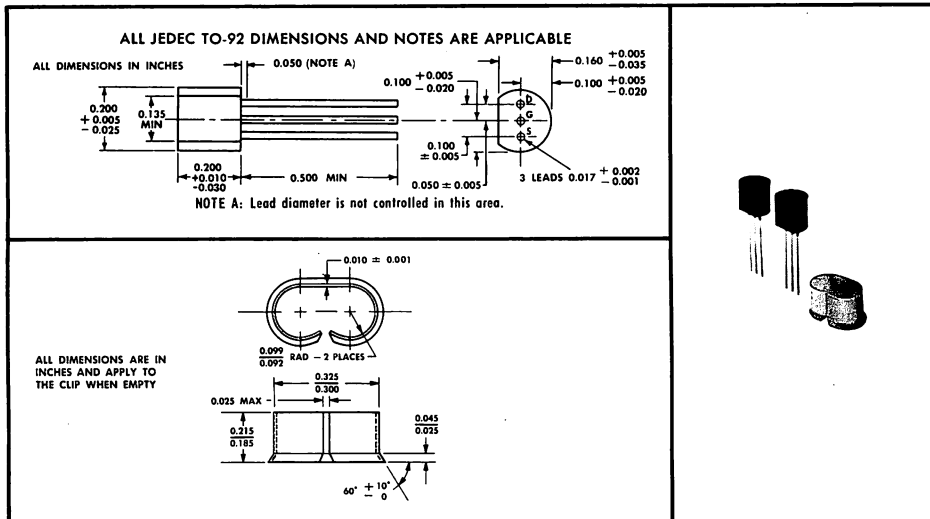

absolute maximum ratings at 25°C free-air temperature (unless otherwise noted)

Drain-Gate Voltage	25 V
Reverse Gate-Source Voltage	-25 V
Continuous Forward Gate Current	30 mA
Continuous Device Dissipation at (or below) 25°C Free-Air Temperature (See Note 1)	360 mW
Storage Temperature Range	-65°C to 150°C
Lead Temperature 1/8 Inch from Case for 10 Seconds	260°C

NOTE 1: Derate linearly to 150°C free-air temperature at the rate of 2.88 mW/deg.

†Trademark of Texas Instruments

‡Patent Pending



TEXAS INSTRUMENTS
INCORPORATED
POST OFFICE BOX 5012 • DALLAS, TEXAS 75222

TYPES TIS68, TIS69, TIS70

N-CHANNEL EPITAXIAL PLANAR SILICON FIELD-EFFECT TRANSISTORS

electrical characteristics at 25°C free-air temperature (unless otherwise noted)
individual triode characteristics

PARAMETER		TEST CONDITIONS	MIN	MAX	UNIT
I_{GSS}	Gate Reverse Current	$V_{GS} = -25\text{ V}, V_{DS} = 0$		-1	μA
		$V_{GS} = -15\text{ V}, V_{DS} = 0$		-2	nA
		$V_{GS} = -15\text{ V}, V_{DS} = 0, T_A = 100^\circ\text{C}$		-2	μA
$V_{GS(off)}$	Gate-Source Cutoff Voltage	$V_{DS} = 15\text{ V}, I_D = 2\text{ nA}$	-0.5	-5	V
I_{DSS}	Zero-Gate-Voltage Drain Current	$V_{DS} = 15\text{ V}, V_{GS} = 0, \text{ See Note 2}$	0.5	8	mA
$ y_{fs} $	Small-Signal Common-Source Forward Transfer Admittance	$V_{DS} = 15\text{ V}, V_{GS} = 0, f = 1\text{ kHz}$	1	6	mmho
$ y_{os} $	Small-Signal Common-Source Output Admittance	$V_{DS} = 15\text{ V}, V_{GS} = 0, f = 1\text{ kHz}$		35	μmho
C_{iss}	Small-Signal Common-Source Input Capacitance	$V_{DS} = 15\text{ V}, V_{GS} = 0, f = 1\text{ MHz}$		8	pF
C_{rss}	Small-Signal Common-Source Reverse Transfer Capacitance	$V_{DS} = 15\text{ V}, V_{GS} = 0, f = 1\text{ MHz}$		4	pF
$ y_{fs} $	Small-Signal Common-Source Forward Transfer Admittance	$V_{DS} = 15\text{ V}, V_{GS} = 0, f = 100\text{ MHz}$	0.8		mmho

triode matching characteristics

PARAMETER	TEST CONDITIONS	TIS68		TIS69		TIS70		UNIT
		MIN	MAX	MIN	MAX	MIN	MAX	
$ I_{GSS1} - I_{GSS2} $	Gate-Reverse-Current Differential $V_{GS} = -15\text{ V}, V_{DS} = 0, T_A = 100^\circ\text{C}$	10		10		10		nA
$ V_{GS1} - V_{GS2} $	Gate-Source-Voltage Differential $V_{DS} = 15\text{ V}, I_D = 50\text{ }\mu\text{A}$	8		16		32		mV
		5		10		15		mV
$ \Delta(V_{GS1} - V_{GS2})_{\Delta T_A} $	Gate-Source-Voltage Differential Change with Temperature $V_{DS} = 15\text{ V}, I_D = 500\text{ }\mu\text{A}, T_{A(1)} = 25^\circ\text{C}, T_{A(2)} = -40^\circ\text{C}$	5		10		15		mV
		5		10		15		mV
$\frac{I_{DSS1}}{I_{DSS2}}$	Zero-Gate-Voltage Drain Current Ratio $V_{DS} = 15\text{ V}, V_{GS} = 0, \text{ See Note 3}$	0.95	1	0.9	1	0.8	1	
$\frac{ y_{fs1} }{ y_{fs2} }$	Small-Signal Common-Source Forward Transfer Admittance Ratio $V_{DS} = 15\text{ V}, V_{GS} = 0, f = 1\text{ kHz}, \text{ See Note 3}$	0.95	1	0.9	1	0.8	1	

NOTES: 2. This parameter must be measured using pulse techniques, $t_p \approx 100\text{ ms}$, duty cycle $\leq 10\%$.

3. The lower of the two characteristic readings is taken as the numerator.

TYPES TIS73, TIS74, TIS75 N-CHANNEL EPITAXIAL PLANAR SILICON FIELD-EFFECT TRANSISTORS



TYPES TIS73, TIS74, TIS75
BULLETIN NO. DL-5 679709, MARCH 1967

SYMMETRICAL N-CHANNEL SILECT† FIELD-EFFECT TRANSISTORS FOR HIGH-SPEED COMMUTATOR AND CHOPPER APPLICATIONS

- **Low $r_{ds(on)}$: 25 Ω Max (TIS73)**
- **Low $I_{D(off)}$: 2 nA Max**
- **Low Drain-Gate Capacitance (C_{rss}): 8 pF Max**
- **Rugged, One-Piece Construction with Standard TO-18 100-mil Pin-Circle**

mechanical data

These transistors are encapsulated in a plastic compound specifically designed for this purpose, using a highly mechanized process‡ developed by Texas Instruments. The case will withstand soldering temperatures without deformation. These devices exhibit stable characteristics under high-humidity conditions and are capable of meeting MIL-STD-202C method 106B. The transistors are insensitive to light.

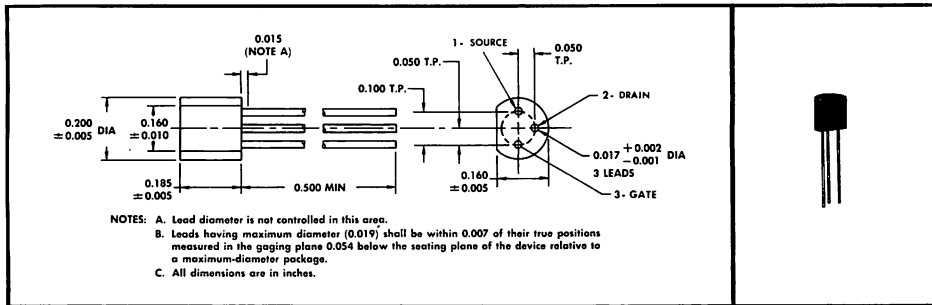

absolute maximum ratings at 25°C free-air temperature (unless otherwise noted)

Drain-Gate Voltage	30 V
Drain-Source Voltage	30 V
Reverse Gate-Source Voltage	-30 V
Continuous Forward Gate Current	50 mA
Continuous Device Dissipation at (or below) 25°C Free-Air Temperature (See Note 1)	360 mW
Continuous Device Dissipation at (or below) 25°C Lead Temperature (See Note 2)	500 mW
Storage Temperature Range	-65°C to 150°C
Lead Temperature 1/16 Inch from Case for 10 Seconds	260°C

NOTES: 1. Derate linearly to 150°C free-air temperature at the rate of 2.88 mW/deg.

2. Derate linearly to 150°C lead temperature at the rate of 4 mW/deg. Lead temperature is measured on the gate lead 1/16 inch from the case.

†Trademark of Texas Instruments

‡Patent Pending



TEXAS INSTRUMENTS
INCORPORATED
POST OFFICE BOX 5012 • DALLAS, TEXAS 75222

TYPES TIS73, TIS74, TIS75

N-CANNEL EPITAXIAL PLANAR SILICON FIELD-EFFECT TRANSISTORS

electrical characteristics at 25°C free-air temperature (unless otherwise noted)

PARAMETER	TEST CONDITIONS	TIS73		TIS74		TIS75		UNIT
		MIN	MAX	MIN	MAX	MIN	MAX	
$V_{(BR)GSS}$ Gate-Source Breakdown Voltage	$I_G = -1 \mu A, V_{DS} = 0$	-30		-30		-30		V
I_{GSS} Gate Reverse Current	$V_{GS} = -15 V, V_{DS} = 0$		-2		-2		-2	nA
	$V_{GS} = -15 V, V_{DS} = 0, T_A = 100^\circ C$		-5		-5		-5	μA
$I_{D(off)}$ Drain Cutoff Current	$V_{DS} = 15 V, V_{GS} = -10 V$		-2		-2		-2	nA
	$V_{DS} = 15 V, V_{GS} = -10 V, T_A = 100^\circ C$		-5		-5		-5	μA
$V_{GS(off)}$ Gate-Source Cutoff Voltage	$V_{DS} = 15 V, I_D = 4 nA$	-4	-10	-2	-6	-0.8	-4	V
I_{DSS} Zero-Gate-Voltage Drain Current	$V_{DS} = 15 V, V_{GS} = 0, \text{ See Note 3}$	50		20	100	8	80	mA
	$I_D = 20 mA, V_{GS} = 0$		0.75					V
$V_{DS(on)}$ Drain-Source On-State Voltage	$I_D = 10 mA, V_{GS} = 0$				0.5			V
	$I_D = 5 mA, V_{GS} = 0$					0.5		V
$r_{ds(on)}$ Small-Signal Drain-Source On-State Resistance	$V_{GS} = 0, I_D = 0, f = 1 kHz$		25		40		60	Ω
C_{iss} Common-Source Short-Circuit Input Capacitance	$V_{DS} = 0, V_{GS} = -10 V, f = 1 MHz$		18		18		18	pF
C_{rss} Common-Source Short-Circuit Reverse Transfer Capacitance	$V_{DS} = 0, V_{GS} = -10 V, f = 1 MHz$		8		8		8	pF

switching characteristics at 25°C free-air temperature

PARAMETER	TEST CONDITIONS	TIS73		TIS74		TIS75		UNIT
		MIN	MAX	MIN	MAX	MIN	MAX	
$t_{d(on)}$ Turn-On Delay Time	$V_{DS} = 10 V,$ $I_{D(on)}^\dagger = \begin{cases} 20 mA (TIS73) \\ 10 mA (TIS74) \\ 5 mA (TIS75) \end{cases}$		6		6		10	ns
t_r Rise Time	$V_{GS(on)} = 0,$ $V_{GS(off)} = \begin{cases} -10 V (TIS73) \\ -6 V (TIS74) \\ -4 V (TIS75) \end{cases}$		3		4		10	ns
t_{off} Turn-Off Time	See Figure 1		25		50		100	ns

NOTE 3: These parameters must be measured using pulse techniques. $t_p \approx 100 ms$, duty cycle $\leq 10\%$.

†These are nominal values, exact values vary slightly with transistor parameters.

TYPES TIS73, TIS74, TIS75 N-CANNEL EPITAXIAL PLANAR SILICON FIELD-EFFECT TRANSISTORS

PARAMETER MEASUREMENT INFORMATION

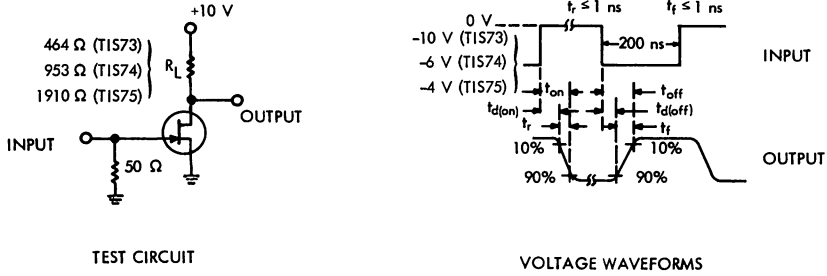

FIGURE 1

- NOTES: a. The input waveforms are supplied by a generator with the following characteristics: $Z_{out} = 50 \Omega$, duty cycle $\approx 2\%$.
b. Waveforms are monitored on an oscilloscope with the following characteristics: $t_r \leq 0.75 \text{ ns}$, $R_{in} \geq 1 \text{ M}\Omega$, $C_{in} \leq 2.5 \text{ pF}$.

TYPICAL CHARACTERISTICS

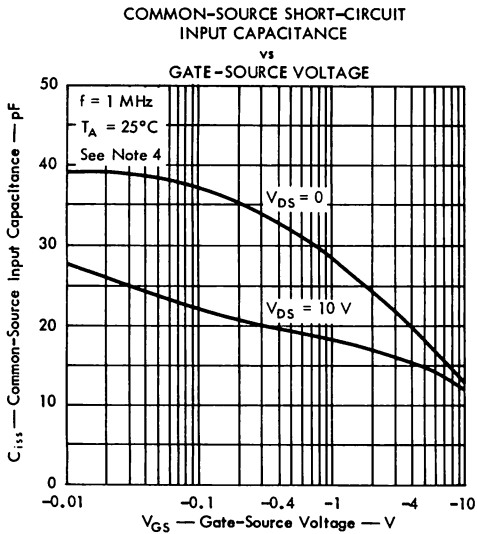

FIGURE 2

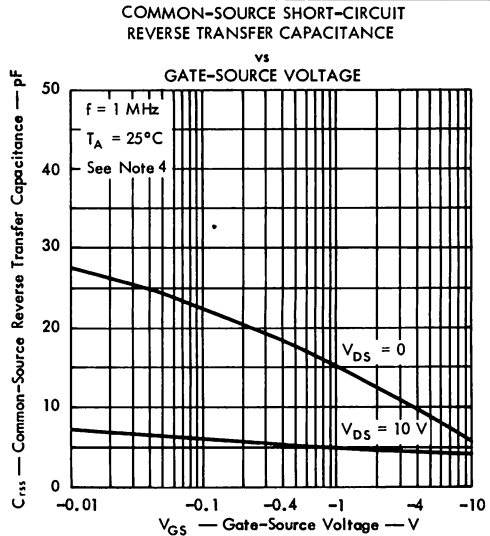

FIGURE 3

NOTE 4: These parameters were measured with bias voltages applied for less than five seconds to avoid overheating the devices.

TYPES TIS73, TIS74, TIS75

N-CHANNEL EPITAXIAL PLANAR SILICON FIELD-EFFECT TRANSISTORS

TYPICAL CHARACTERISTICS

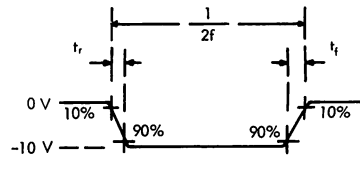
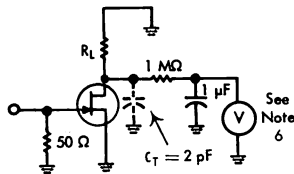
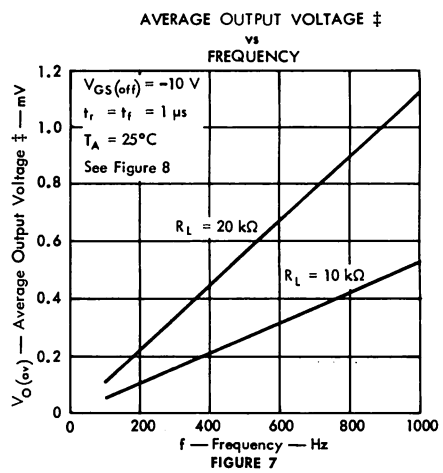
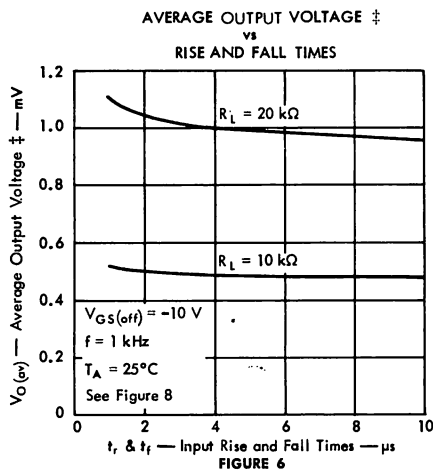
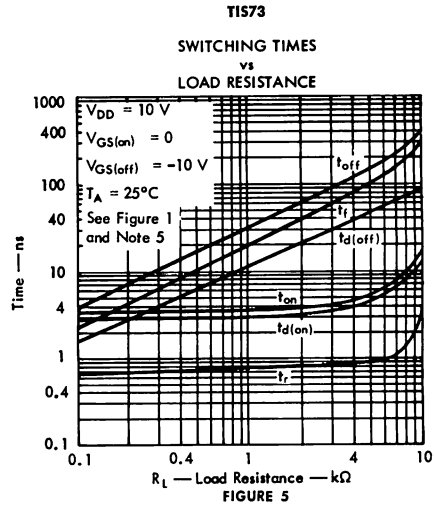
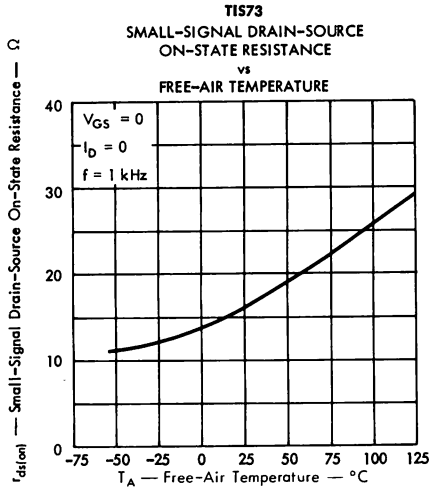

FIGURE 8—MEASUREMENT INFORMATION FOR FIGURES 6 & 7

- NOTES: 5. The circuit of figure 1 is used, varying R_L from 100 Ω to 10 k Ω . $t_p = 1 \mu s$, duty cycle $\leq 2\%$.
6. Voltmeter input resistance $R_{in} \geq 10 M\Omega$.

‡In the circuit of figure 8, Average Output Voltage results from capacitive feed-through of the gate-drive signal.

TYPE TIS88 N-CHANNEL EPITAXIAL PLANAR SILICON FIELD-EFFECT TRANSISTOR



TYPE TIS88
BULLETIN NO. DLS-6710200, JUNE 1967

N-CHANNEL SILECT† FIELD-EFFECT TRANSISTOR FOR VHF AMPLIFIER AND MIXER APPLICATIONS

- High Power Gain . . . 10 dB Min at 400 MHz
- High Transconductance . . . 4000 μ mho Min at 400 MHz
- Low C_{RSS} . . . 1 pF Max
- High $|y_{fs}|/C_{iss}$ Ratio (High-Frequency Figure-of-Merit)
- Drain and Gate Leads Separated for High Maximum Stable Gain
- Cross-Modulation Minimized by Square-Law Transfer Characteristic
- For Use in VHF Amplifiers in FM, TV, and Mobile Communications Equipment

mechanical data

This transistor is encapsulated in a plastic compound specifically designed for this purpose, using a highly mechanized process‡ developed by Texas Instruments. The case will withstand soldering temperatures without deformation. This device exhibits stable characteristics under high-humidity conditions and is capable of meeting MIL-STD-202C method 106B. The transistor is insensitive to light.

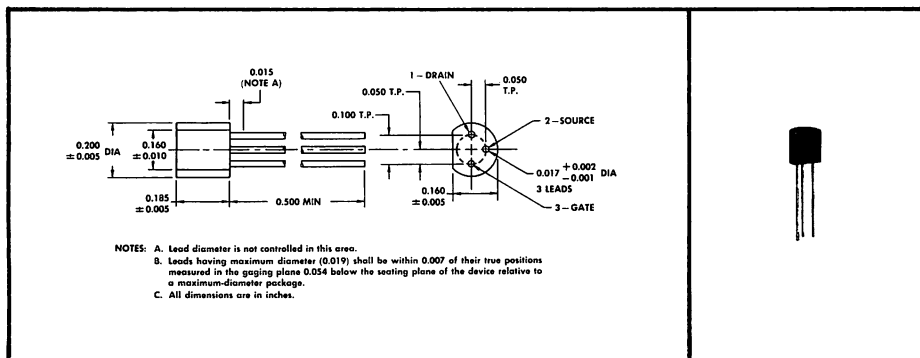

absolute maximum ratings at 25°C free-air temperature (unless otherwise noted)

Drain-Gate Voltage	30 V
Drain-Source Voltage	30 V
Reverse Gate-Source Voltage	-30 V
Continuous Forward Gate Current	50 mA
Continuous Device Dissipation at (or below) 25°C Free-Air Temperature (See Note 1)	360 mW
Continuous Device Dissipation at (or below) 25°C Lead Temperature (See Note 2)	500 mW
Storage Temperature Range	-65°C to 150°C
Lead Temperature 1/16 Inch from Case for 10 Seconds	260°C

NOTES: 1. Derate linearly to 150°C free-air temperature at the rate of 2.88 mW/deg.

2. Derate linearly to 150°C lead temperature at the rate of 4 mW/deg. Lead temperature is measured on the gate lead 1/16 inch from the case.

†Trademark of Texas Instruments

‡Patent pending



TEXAS INSTRUMENTS
INCORPORATED
POST OFFICE BOX 5012 • DALLAS, TEXAS 75222

TYPE TIS88

N-CHANNEL EPITAXIAL PLANAR SILICON FIELD-EFFECT TRANSISTOR

electrical characteristics at 25°C free-air temperature (unless otherwise noted)

PARAMETER		TEST CONDITIONS	MIN	MAX	UNIT
$V_{(BR)ESS}$	Gate-Source Breakdown Voltage	$I_G = -1 \mu A, V_{DS} = 0$	-30		V
I_{ESS}	Gate Reverse Current	$V_{GS} = -20 V, V_{DS} = 0$		-1	nA
		$V_{GS} = -20 V, V_{DS} = 0, T_A = 100^\circ C$		-0.5	μA
$V_{GS(off)}$	Gate-Source Cutoff Voltage	$V_{DS} = 15 V, I_D = 10 nA$	-1	-6	V
I_{DSS}	Zero-Gate-Voltage Drain Current	$V_{DS} = 15 V, V_{GS} = 0$, See Note 3	5	15	mA
$ y_{fs} $	Small-Signal Common-Source Forward Transfer Admittance	$V_{DS} = 15 V, V_{GS} = 0, f = 1 kHz$	4.5	7.5	mmho
$ y_{os} $	Small-Signal Common-Source Output Admittance	$V_{DS} = 15 V, V_{GS} = 0, f = 1 kHz$		0.05	mmho
C_{iss}	Common-Source Short-Circuit Input Capacitance	$V_{DS} = 15 V, V_{GS} = 0$		4.5	pF
C_{rss}	Common-Source Short-Circuit Reverse Transfer Capacitance	$f = 1 MHz$		1	pF
$Re(y_{is})$	Small-Signal Common-Source Input Conductance	$V_{DS} = 15 V, V_{GS} = 0, f = 100 MHz$		0.1	mmho
$Im(y_{is})$	Small-Signal Common-Source Input Susceptance			3	mmho
$Re(y_{os})$	Small-Signal Common-Source Output Conductance			0.075	mmho
$Im(y_{os})$	Small-Signal Common-Source Output Susceptance			0.9	mmho
$Re(y_{fs})$	Small-Signal Common-Source Forward Transfer Conductance			1	mmho
$Im(y_{fs})$	Small-Signal Common-Source Forward Transfer Susceptance	$V_{DS} = 15 V, V_{GS} = 0, f = 400 MHz$		12	mmho
$Re(y_{fs})$	Small-Signal Common-Source Forward Transfer Conductance			4	mmho
$Re(y_{os})$	Small-Signal Common-Source Output Conductance			0.1	mmho
$Im(y_{os})$	Small-Signal Common-Source Output Susceptance			4	mmho

NOTE 3: This parameter must be measured using pulse techniques. $t_p = 300 \mu s$, duty cycle $\leq 2\%$.

operating characteristics at 25°C free-air temperature

PARAMETER		TEST CONDITIONS	MIN	MAX	UNIT
G_{ps}	Small-Signal Common-Source Neutralized Insertion Power Gain	$V_{DS} = 15 V, I_D = 5 mA, f = 100 MHz, R_{G'} = 1 k\Omega$, See Figure 1		18	dB
		$V_{DS} = 15 V, I_D = 5 mA, f = 400 MHz, R_{G'} = 1 k\Omega$, See Figure 1		10	
NF	Spot Noise Figure	$V_{DS} = 15 V, I_D = 5 mA, f = 100 MHz, R_{G'} = 1 k\Omega$, See Figure 1		2	dB
		$V_{DS} = 15 V, I_D = 5 mA, f = 400 MHz, R_{G'} = 1 k\Omega$, See Figure 1		4	

TYPE T1S88 N-CANNEL EPITAXIAL PLANAR SILICON FIELD-EFFECT TRANSISTOR

PARAMETER MEASUREMENT INFORMATION

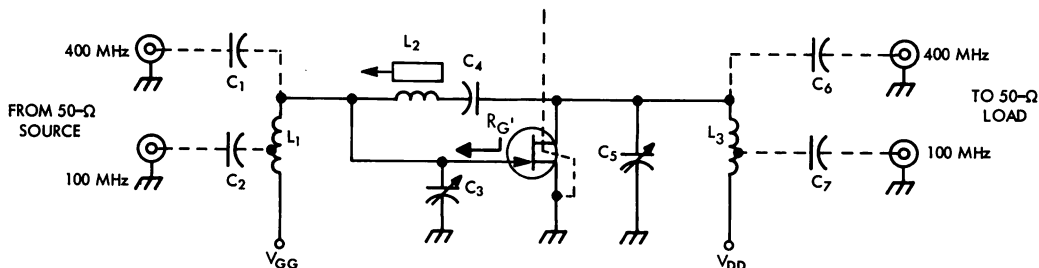

CIRCUIT COMPONENT INFORMATION					
CAPACITORS			COILS		
	100 MHz	400 MHz		100 MHz	400 MHz
C_1	not used	1.8 pF	L_1	8.5 T, #16 copper, tapped 2.5 T from bottom, 3/8" ID, 1 1/4" long	1.25 T, #20 copper, 3/16" ID, 3/8" long
C_2	7 pF	not used			
C_3	1-12 pF	0.8-8 pF	L_2	15 T, #20 enameled copper, close-wound, 1/4" ID	4 T, #20 enameled copper, close-wound, 3/16" ID
C_4	1000 pF	27 pF			
C_5	1-12 pF	0.8-8 pF	L_3	13.5 T, #16 copper, tapped 5 T from bottom, 3/8" ID, 1 1/4" long	0.5 T, #20 copper, 1/2" ID, no length
C_6	not used	1 pF			
C_7	3 pF	not used			

FIGURE 1 — SCHEMATIC AND COMPONENT INFORMATION FOR 100-MHz AND 400-MHz NEUTRALIZED INSERTION POWER GAIN AND SPOT NOISE FIGURE TEST CIRCUITS

TYPICAL CHARACTERISTICS

GATE REVERSE CURRENT
vs
FREE-AIR TEMPERATURE

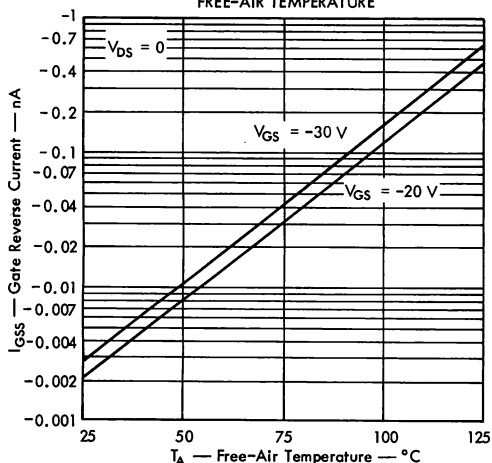

FIGURE 2

CORRELATION OF SMALL-SIGNAL COMMON-SOURCE
FORWARD TRANSFER ADMITTANCE and
GATE-SOURCE CUTOFF VOLTAGE

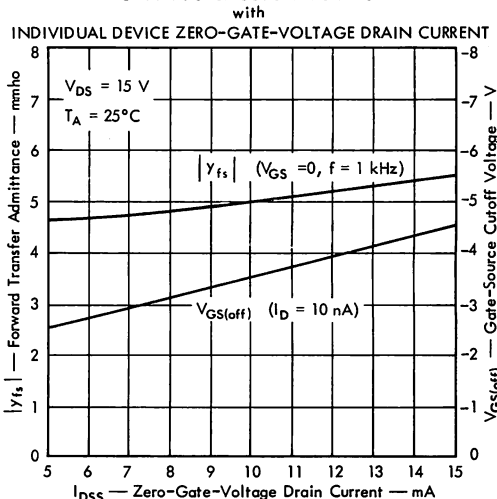

FIGURE 3

TYPE TIS88

N-CHANNEL EPITAXIAL PLANAR SILICON FIELD-EFFECT TRANSISTOR

TYPICAL CHARACTERISTICS

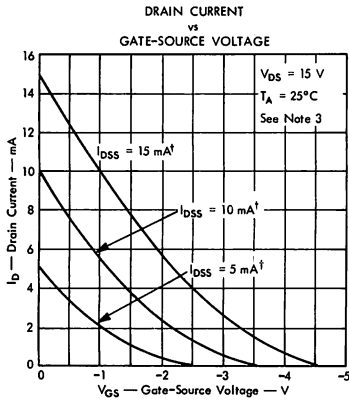

FIGURE 4

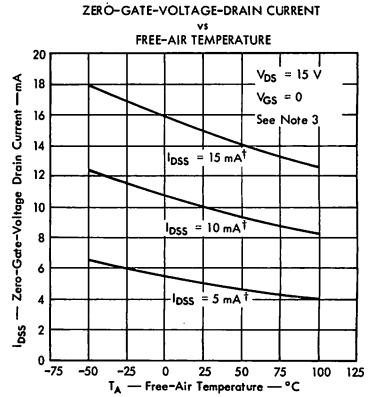

FIGURE 5

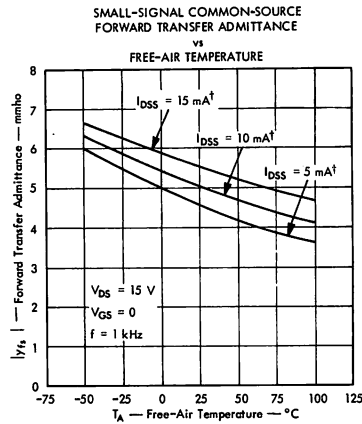

FIGURE 6

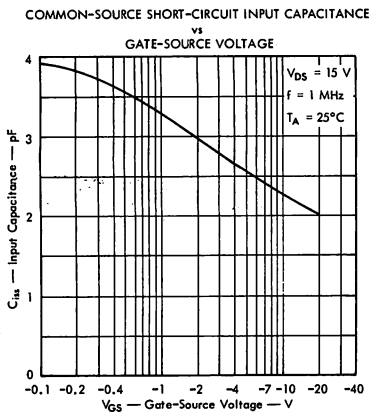

FIGURE 7

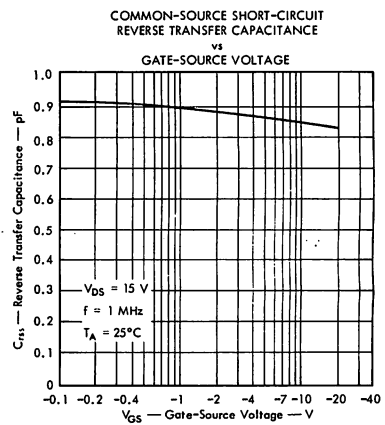

FIGURE 8

NOTE 3: This parameter must be measured using pulse techniques. $t_p = 300\ \mu\text{s}$, duty cycle $\leq 2\%$.

† Data is for devices having the indicated values of I_{DSS} at $V_{DS} = 15\text{ V}$, $V_{GS} = 0$, and $T_A = 25^\circ\text{C}$.

TYPE T1S88 N-CHANNEL EPITAXIAL PLANAR SILICON FIELD-EFFECT TRANSISTOR

TYPICAL CHARACTERISTICS

SMALL-SIGNAL COMMON-SOURCE INPUT ADMITTANCE
vs
NORMALIZED DRAIN CURRENT

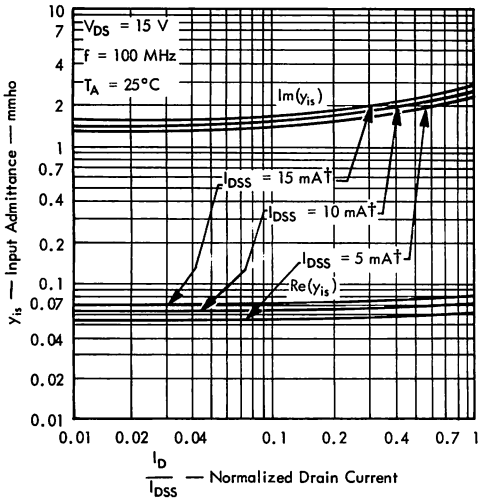

FIGURE 9

SMALL-SIGNAL COMMON-SOURCE
FORWARD TRANSFER ADMITTANCE
vs
NORMALIZED DRAIN CURRENT

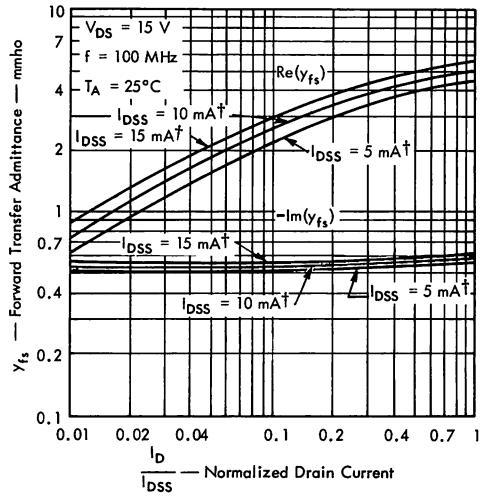

FIGURE 10

SMALL-SIGNAL COMMON-SOURCE
REVERSE TRANSFER ADMITTANCE
vs
NORMALIZED DRAIN CURRENT

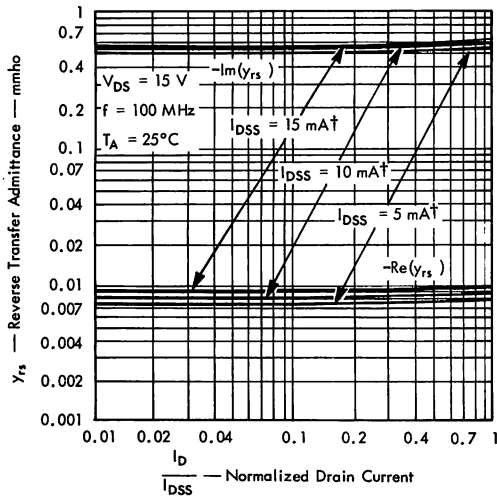

FIGURE 11

SMALL-SIGNAL COMMON-SOURCE OUTPUT ADMITTANCE
vs
NORMALIZED DRAIN CURRENT

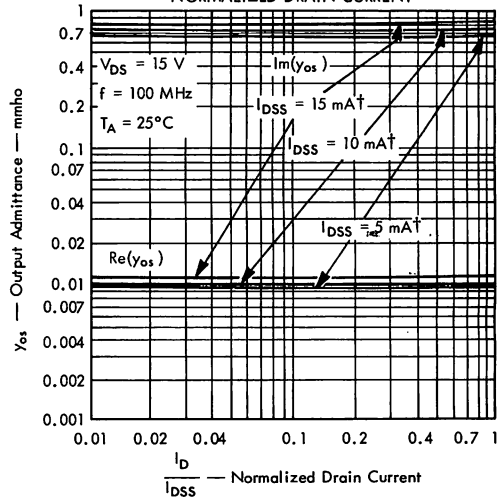

FIGURE 12

†Data is for devices having the indicated values of I_{DSS} at $V_{DS} = 15\text{ V}$, $V_{GS} = 0$, and $T_A = 25^\circ\text{C}$.

TYPE TIS88

N-CANNEL EPITAXIAL PLANAR SILICON FIELD-EFFECT TRANSISTOR

TYPICAL CHARACTERISTICS

SMALL-SIGNAL COMMON-SOURCE INPUT ADMITTANCE

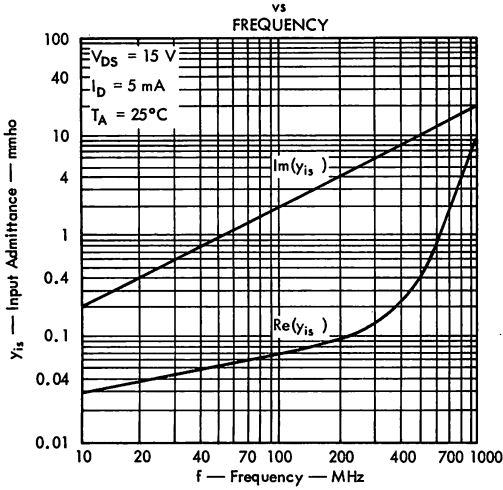

FIGURE 13

SMALL-SIGNAL COMMON-SOURCE FORWARD TRANSFER ADMITTANCE

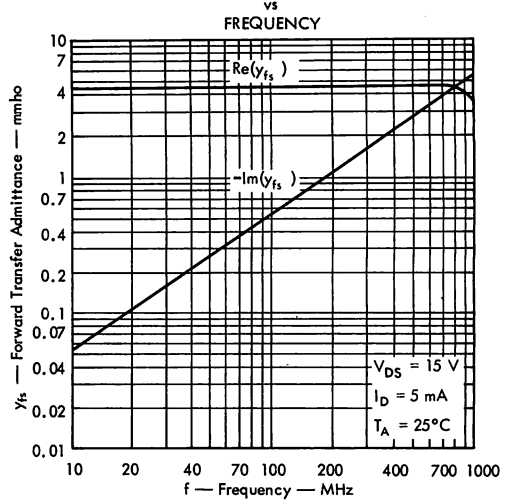

FIGURE 14

SMALL-SIGNAL COMMON-SOURCE REVERSE TRANSFER ADMITTANCE

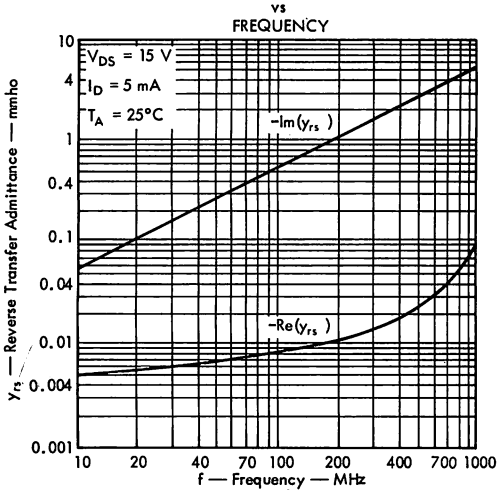

FIGURE 15

SMALL-SIGNAL COMMON-SOURCE OUTPUT ADMITTANCE

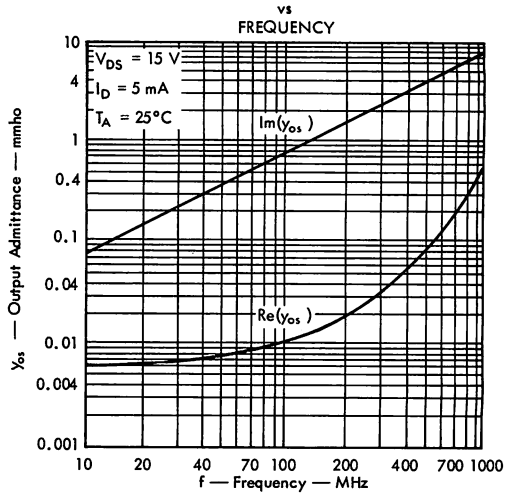

FIGURE 16

TYPE TIS88

N-CHANNEL EPITAXIAL PLANAR SILICON FIELD-EFFECT TRANSISTOR

TYPICAL CHARACTERISTICS

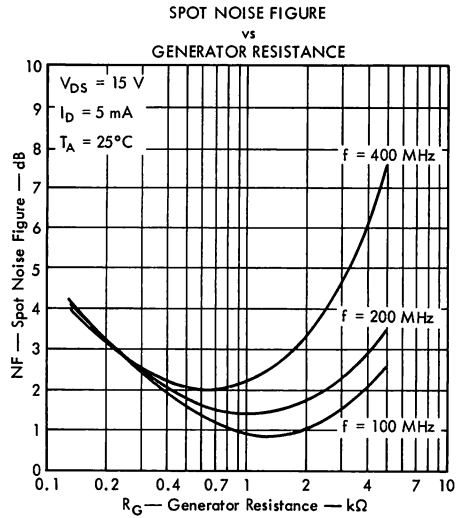

FIGURE 17

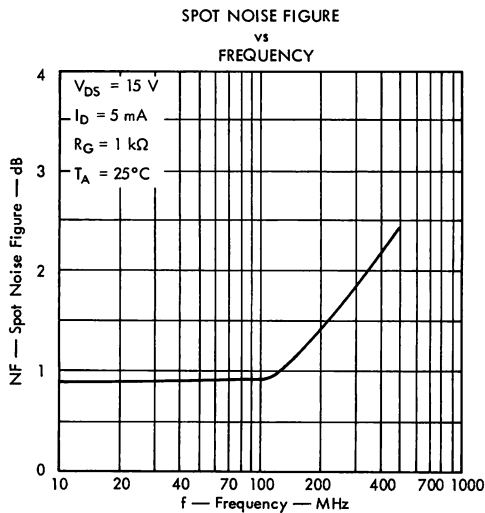
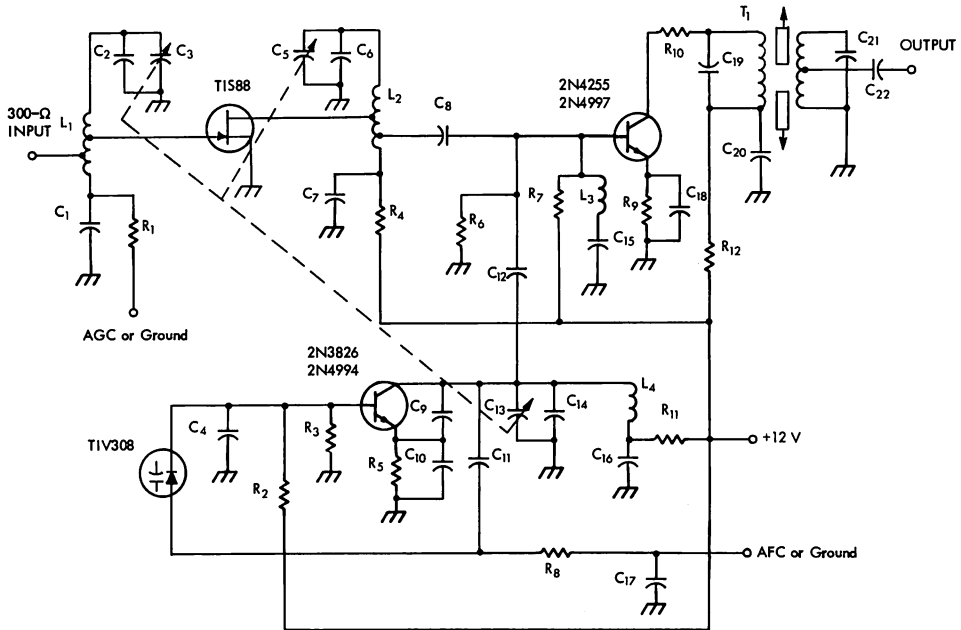

FIGURE 18

TYPE TIS88

N-CHANNEL EPITAXIAL PLANAR SILICON FIELD-EFFECT TRANSISTOR

TYPICAL APPLICATION DATA



TYPICAL TUNER PERFORMANCE AT $f_0 = 98 \text{ MHz}$	
Image Rejection (119.4 MHz)	47 dB
$f_0 + \frac{1}{2} \text{ IF Rejection (103.35 MHz)}$	73 dB
Sensitivity for 30-dB $\frac{S + N}{N}$ ($\pm 75\text{-kHz}$ deviation)	2.3 μV
Sensitivity for 30-dB $\frac{S + N}{N}$ ($\pm 22.5\text{-kHz}$ deviation)	3.4 μV
Voltage Gain from Input to Primary of IF Transformer	37 dB

CIRCUIT COMPONENT INFORMATION

CAPACITORS

C_1 : 0.001 μF	C_{12} : 1.2 pF
C_2 : 10 pF	C_{13} : †
C_3 : †	C_{14} : 10 pF
C_4 : 0.001 μF	C_{15} : 240 pF
C_5 : †	C_{16} : 0.001 μF
C_6 : 10 pF	C_{17} : 0.1 μF
C_7 : 0.001 μF	C_{18} : 0.01 μF
C_8 : 12 pF	C_{19} : 47 pF
C_9 : 4.7 pF	C_{20} : 0.01 μF
C_{10} : 6.8 pF	C_{21} : 100 pF
C_{11} : 4.7 pF	C_{22} : 0.01 μF

†Three-gang, 6–21 pF each, with trimmers.

RESISTORS

R_1 : 27 k Ω	R_7 : 10 k Ω
R_2 : 10 k Ω	R_8 : 330 k Ω
R_3 : 2.7 k Ω	R_9 : 820 Ω
R_4 : 330 Ω	R_{10} : 120 Ω
R_5 : 1 k Ω	R_{11} : 330 Ω
R_6 : 2.7 k Ω	R_{12} : 330 Ω

All resistors $\frac{1}{2}$ W, ten percent tolerance

TRANSFORMER

T_1 : 10.7 MHz IF transformer

COILS

- L_1 : 2.5 T, #16 bus, $\frac{1}{4}$ " ID, carbonyl "E" core, tapped at 1 T and 2 T from bottom
- L_2 : 4 T, #16 bus, $\frac{1}{4}$ " ID, air core, tapped at 1.3 T and 1 T from bottom
- L_3 : 1 μH
- L_4 : 3 T, #16 bus, $\frac{1}{4}$ " ID, carbonyl "E" core

FIGURE 19 — TYPICAL FM TUNER

P-CHANNEL DIFFUSED PLANAR SILICON FIELD-EFFECT TRANSISTOR



TYPE 2N2386
BULLETIN NO. DI-5-683860, JULY 1963
REVISED MAY 1968

FOR INDUSTRIAL SMALL-SIGNAL APPLICATIONS

- High Input Impedance (> 3 megohms at 1 kc)

*mechanical data

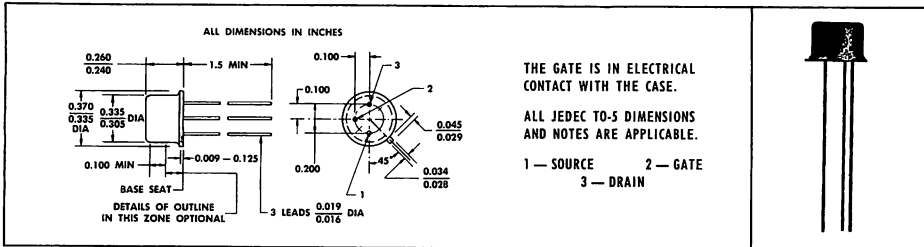

*absolute maximum ratings at 25°C free-air temperature (unless otherwise noted)

Continuous Forward Gate Current	-10 ma
Continuous Device Dissipation at (or below) 25°C Free-Air Temperature (See Note 1)	0.5 w
Continuous Device Dissipation at (or below) 25°C Case Temperature (See Note 2)	1.5 w
Storage Temperature Range	-65°C to 200°C

*electrical characteristics at 25°C free-air temperature (unless otherwise noted)

PARAMETER	TEST CONDITIONS	MIN	MAX	UNIT
BV_{DGO} Drain-Gate Breakdown Voltage (See Note 3)	$I_D = -10 \mu a, I_S = 0$	-20		v
I_{GSS} Gate Cutoff Current	$V_{GS} = 10 v, V_{DS} = 0$ $V_{GS} = 10 v, V_{DS} = 0, T_A = 100^\circ C$		0.01 1.0	μa μa
$I_{D(off)}$ Pinch-Off Drain Current	$V_{DS} = -12 v, V_{GS} = 8 v$		-10	μa
$ y_{is} $ Small-Signal Common-Source Input Admittance	$V_{DS} = -10 v, V_{GS} = 0, f = 1 kc$		0.3	μmho
$ y_{fs} $ Small-Signal Common-Source Forward Transfer Admittance	$V_{DS} = -10 v, V_{GS} = 0, f = 1 kc$	1000		μmho
C_{iss} Common-Source Short-Circuit Input Capacitance	$V_{DS} = -10 v, V_{GS} = 0, f = 140 kc$		50	pf

NOTES: 1. Derate linearly to 175°C free-air temperature at the rate of 3.3 mw/C°.
 2. Derate linearly to 175°C case temperature at the rate of 10 mw/C°.
 3. This parameter corresponds closely to BV_{DSS} (the Drain-Source Breakdown Voltage for $V_{GS} = 0$). BV_{DSX} (the Drain-Source Breakdown Voltage for other values of V_{GS}) may be calculated from: $|BV_{DSX}| \cong |BV_{DGO}| - |V_{GS}|$.

*Indicates JEDEC registered data

TYPE 2N2386

P-CHANNEL DIFFUSED PLANAR SILICON FIELD-EFFECT TRANSISTOR

BIAS DESIGN CURVE FOR TYPICAL UNITS

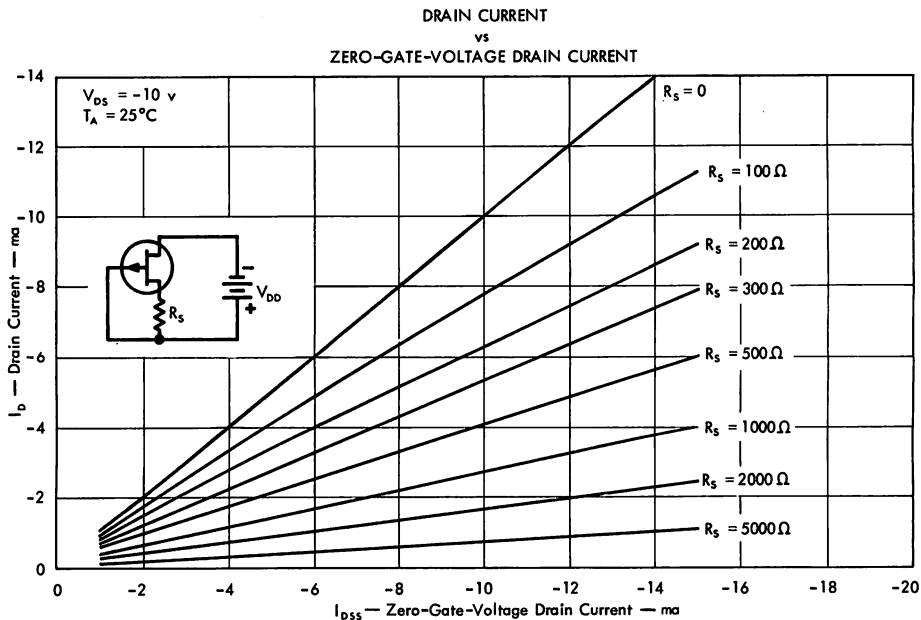

TYPICAL APPLICATION DATA

HIGH-INPUT-IMPEDANCE AMPLIFIER

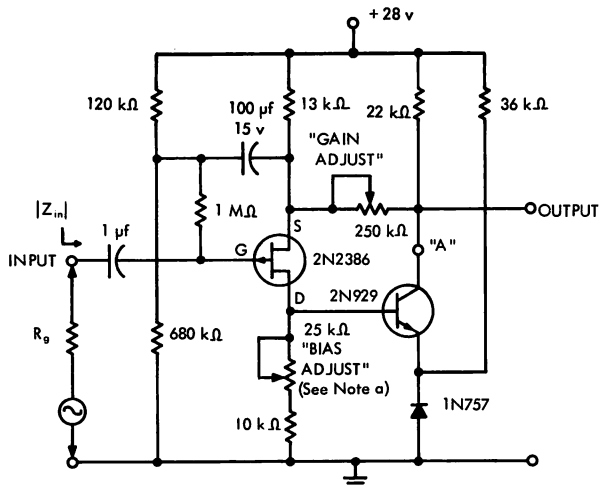

NOTES: a. Adjust for +18 v at Point "A".
b. All resistors ± 5% tolerance, 1/2 watt.

TYPICAL SMALL-SIGNAL CIRCUIT PERFORMANCE CHARACTERISTICS

FREQUENCY	$ Z_{in} \dagger$
10 cps	70 MΩ
100 cps	70 MΩ
1 kc	50 MΩ
10 kc	10 MΩ

R_o	3-db BANDWIDTH †
100 kΩ	1 cps to 200 kc
1 MΩ	1 cps to 50 kc
10 MΩ	1 cps to 8 kc

VOLTAGE GAIN
Adjustable from 1 to 20

† $T_A = 25^\circ\text{C}$, "Gain Adjust" set for Gain of 10

TYPES 2N2497, 2N2498, 2N2499, 2N2500

P-CHANNEL DIFFUSED PLANAR SILICON FIELD-EFFECT TRANSISTORS



TYPES 2N2497, 2N2498, 2N2499, 2N2500
 BULLETIN NO. DL-5 683519, MAY 1963
 REVISED MAY 1968

FOR SMALL-SIGNAL, LOW-NOISE APPLICATIONS

- Guaranteed 10 cps Noise Figure (2N2500)
- High Input Impedance (>5 megohms at 1 kc)
- High Nuclear Radiation-Damage Resistance

*mechanical data

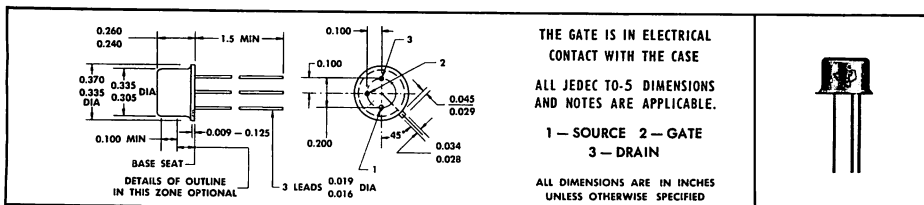

*absolute maximum ratings at 25°C free-air temperature (unless otherwise noted)

Continuous Forward Gate Current	-10 ma
Total Device Dissipation at (or below) 25°C Free-Air Temperature (See Note 1)	0.5 w
Total Device Dissipation at (or below) 25°C Case Temperature (See Note 2)	1.5 w
Storage Temperature Range	-195°C to +200°C

*electrical characteristics at 25°C free-air temperature (unless otherwise noted)

PARAMETER	TEST CONDITIONS	2N2497		2N2498		2N2499		2N2500		UNIT
		MIN	MAX	MIN	MAX	MIN	MAX	MIN	MAX	
BV_{DGO} Drain-Gate Breakdown Voltage (See Note 3)	$I_D = -10 \mu a, I_S = 0$	-20		-20		-20		-20		v
I_{GSS} Gate Cutoff Current	$V_{GS} = 10 v, V_{DS} = 0$		0.01		0.01		0.01		0.01	μa
I_{GSS} Gate Cutoff Current	$V_{GS} = 10 v, V_{DS} = 0, T_A = 150^\circ C$		10		10		10		10	μa
I_{DSS} Zero-Gate-Voltage Drain Current	$V_{DS} = -10 v, V_{GS} = 0$	-1	-3	-2	-6	-5	-15	-1	-6	ma
$I_{D(off)}$ Pinch-Off Drain Current	$V_{DS} = -15 v, V_{GS}$: See Note 4		-10		-10		-10		-10	μa
r_{DS} Static Drain-Source Resistance	$I_D = -100 \mu a, V_{GS} = 0$		1000		800		600			ohm
$ Y_{is} $ Small-Signal Common-Source Input Admittance			0.2		0.2		0.2		0.2	μmho
$ Y_{fs} $ Small-Signal Common-Source Forward Transfer Admittance	$V_{DS} = -10 v, I_D$: See Note 5	1000	2000	1500	3000	2000	4000	1000	2200	μmho
$ Y_{rs} $ Small-Signal Common-Source Reverse Transfer Admittance	$f = 1 kc$		0.1		0.1		0.1		0.1	μmho
$ Y_{os} $ Small-Signal Common-Source Output Admittance			20		40		100		20	μmho
$ Y_{fs} $ Small-Signal Common-Source Forward Transfer Admittance	$V_{DS} = -10 v, f = 10 mc, I_D$: See Note 5	900		1350		1800		900		μmho
C_{iss} Common-Source Short-Circuit Input Capacitance	$V_{GS} = 0, V_{DS} = -10 v, f = 140 kc$		32		32		32		32	pf

*operating characteristics at 25°C free-air temperature

NF	Spot Noise Figure	$V_{DS} = -5 v, f = 1 kc, R_G = 1 M\Omega$	$I_D = -1 ma$							
				3		3		4	1	db
		$V_{DS} = -5 v, f = 10 cps, R_G = 10 M\Omega$	$I_D = -1 ma$						5	db

NOTES: 1. Derate linearly to 175°C free-air temperature at the rate of 3.3 mw/°C.
 2. Derate linearly to 175°C case temperature at the rate of 10 mw/°C.
 3. This parameter corresponds closely to BV_{DSS} (the Drain-Source Breakdown Voltage for $V_{GS} = 0$). BV_{DSX} (the Drain-Source Breakdown Voltage for other values of V_{GS}) may be calculated from:
 $|BV_{DSX}| \cong |BV_{DGO}| - |V_{GS}|$

	2N2497	2N2498	2N2499	2N2500
NOTE 4: $V_{GS} =$	5 v	6 v	8 v	6 v
NOTE 5: $I_D =$	-1 ma	-2 ma	-5 ma	-1 ma

*Indicates JEDEC registered data.



TEXAS INSTRUMENTS
 INCORPORATED
 POST OFFICE BOX 5012 • DALLAS, TEXAS 75222

TYPES 2N2497, 2N2498, 2N2499, 2N2500

P-CHANNEL DIFFUSED PLANAR SILICON FIELD-EFFECT TRANSISTORS

PARAMETER MEASUREMENT INFORMATION

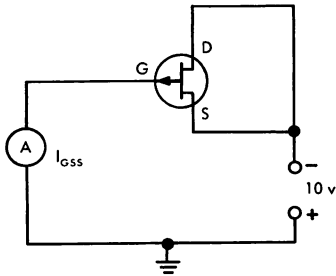
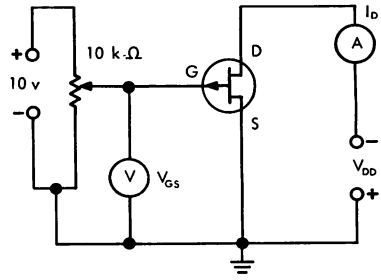

FIGURE 1 — GATE CUTOFF CURRENT TEST CIRCUIT



* FIGURE 2 — PINCH-OFF DRAIN CURRENT TEST CIRCUIT

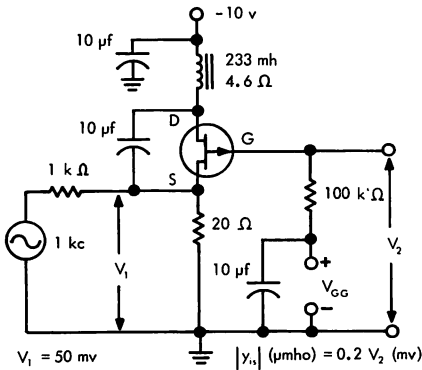

FIGURE 3 — INPUT ADMITTANCE TEST CIRCUIT

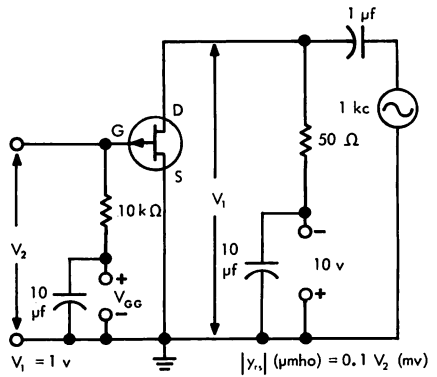
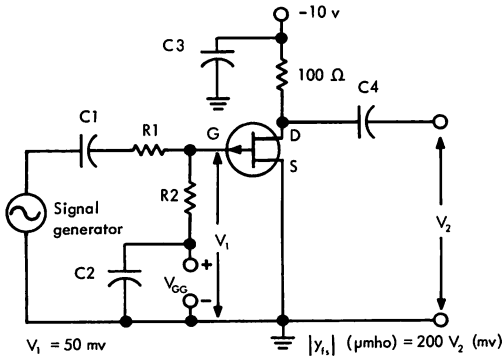

FIGURE 4 — REVERSE TRANSFER ADMITTANCE TEST CIRCUIT



f	R1	R2	C1	C2	C3	C4
1 kc	1 k Ω	10 Ω	10 μf	10 μf	10 μf	10 μf
10 mc	30 Ω	20 Ω	39 pf	0.02 μf	0.02 μf	0.02 μf

FIGURE 5 — FORWARD TRANSFER ADMITTANCE TEST CIRCUIT

* Indicates JEDEC registered data.

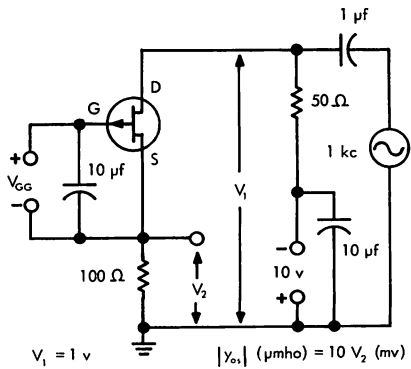

FIGURE 6 — OUTPUT ADMITTANCE TEST CIRCUIT

TYPES 2N3329, 2N3330, 2N3331, 2N3332 P-CHANNEL DIFFUSED PLANAR SILICON FIELD-EFFECT TRANSISTORS



FOR SMALL-SIGNAL, LOW-NOISE APPLICATIONS

- Active Elements Insulated from Case
- High Input Impedance (> 5 megohms at 1 kc)
- High Nuclear Radiation-Damage Resistance

*mechanical data

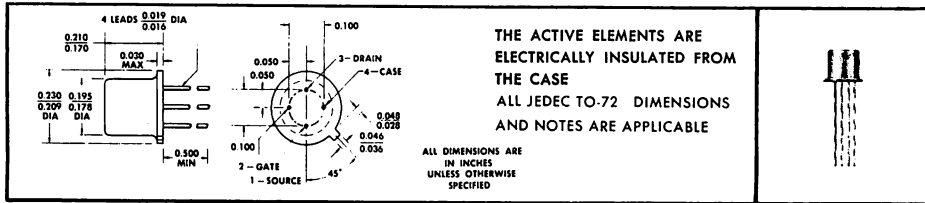

TYPES 2N3329, 2N3330, 2N3331, 2N3332
BULLETIN NO. DL-5 644905, MARCH 1964

*absolute maximum ratings at 25°C free-air temperature (unless otherwise noted)

Gate Current	-10 ma
Total Device Dissipation at (or below) 25°C Free-Air Temperature (See Note 1)	0.3 w
Storage Temperature Range	-65°C to +200°C

*electrical characteristics at 25°C free-air temperature (unless otherwise noted)

PARAMETER	TEST CONDITIONS†	2N3329		2N3330		2N3331		2N3332		UNIT
		MIN	MAX	MIN	MAX	MIN	MAX	MIN	MAX	
BV_{GS} Gate-Source Breakdown Voltage	$I_G = 10 \mu a, V_{DS} = 0$	20		20		20		20		v
I_{GSS} Gate Cutoff Current	$V_{GS} = 10 v, V_{DS} = 0$		0.01		0.01		0.01		0.01	μa
I_{GSS} Gate Cutoff Current	$V_{GS} = 10 v, V_{DS} = 0, I_A = 150^\circ C$		10		10		10		10	μa
I_{DSS} Zero-Gate-Voltage Drain Current	$V_{DS} = -10 v, V_{GS} = 0$	-1	-3	-2	-6	-5	-15	-1	-6	ma
V_{GS} Gate-Source Cutoff Voltage	$V_{DS} = -15 v, I_D = -10 \mu a$		5		6		8		6	v
r_{DS} Static Drain-Source Resistance	$I_D = -100 \mu a, V_{GS} = 0$		1000		800		600			ohm
$ y_{fs} $ Small-Signal Common-Source Input Admittance	$V_{DS} = -10 v, I_D$ - See Note 2, $f = 1 kc$		0.2		0.2		0.2		0.2	μmho
$ y_{fs} $ Small-Signal Common-Source Forward Transfer Admittance		1000	2000	1500	3000	2000	4000	1000	2200	μmho
$ y_{rs} $ Small-Signal Common-Source Reverse Transfer Admittance			0.1		0.1		0.1		0.1	μmho
$ y_{os} $ Small-Signal Common-Source Output Admittance			20		40		100		20	μmho
$ y_{fs} $ Small-Signal Common-Source Forward Transfer Admittance	$V_{DS} = -10 v, I_D$ - See Note 2, $f = 10 Mc$	900		1350		1800		900		μmho
C_{iss} Common-Source Short-Circuit Input Capacitance	$V_{DS} = -10 v, V_{GS} = 1 v, f = 1 Mc$		20		20		20		20	pf

*operating characteristics at 25°C free-air temperature

NF Spot Noise Figure	$V_{DS} = -5 v, I_D = -1 ma, f = 1 kc, R_G = 1 M\Omega$	3	3	4	1	db
	$V_{DS} = -5 v, I_D = -1 ma, f = 10 cps, R_G = 10 M\Omega$				5	db

NOTE 1: Derate linearly to 175°C free-air temperature at the rate of 2 mw/C°.

	2N3329	2N3330	2N3331	2N3332
NOTE 2: $I_D =$	-1 ma	-2 ma	-5 ma	-1 ma

†The fourth lead (case) is connected to the source for all measurements.

*Indicates JEDEC registered data.



TEXAS INSTRUMENTS
INCORPORATED
POST OFFICE BOX 5012 • DALLAS, TEXAS 75222

TI Microlibrary Books for Creative Circuit Designers

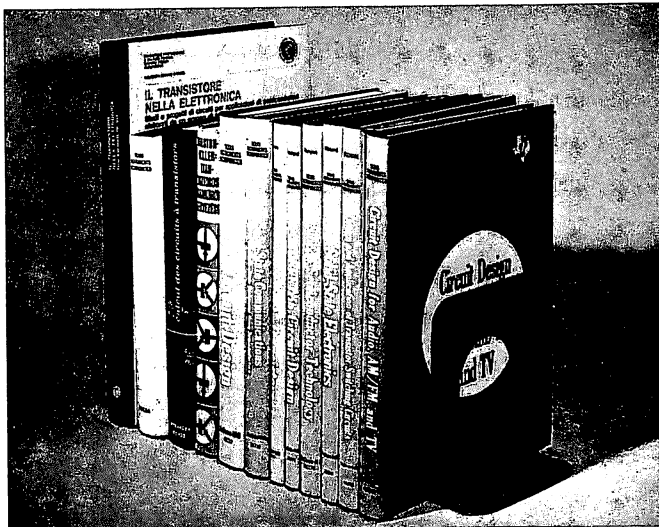

TRANSISTOR CIRCUIT DESIGN

523 Pages • 526 Illustrations • Published January '63 •
Shipping Weight 3-lb 4 oz • \$15.00

FIELD-EFFECT TRANSISTORS • L. J. SEVIN

138 Pages • 137 Illustrations • Published April '65 •
Shipping Weight 1-lb 10-oz • \$10.00

MOSFET IN CIRCUIT DESIGN • ROBERT H. CRAWFORD

136 Pages • 100 Illustrations • Published May '67 •
Shipping Weight 1-lb 10-oz • \$10.00

CIRCUIT DESIGN FOR AUDIO, AM/FM AND TV

352 Pages • 145 Illustrations • Published February '67 •
Shipping Weight 2-lb 8-oz • \$14.50

SILICON SEMICONDUCTOR TECHNOLOGY • W. R. RUNYAN

256 Pages • 301 Illustrations • Published May '65 •
Shipping Weight 2-lb 9-oz • \$16.50

DESIGN AND APPLICATION OF TRANSISTOR SWITCHING CIRCUITS • LOUIS DELHOM

278 Pages • 315 Illustrations • Published January '68 •
Shipping Weight 2-lb • \$14.50

SOLID STATE COMMUNICATIONS

366 Pages • 417 Illustrations • Published April '66 •
Shipping Weight 2-lb 9-oz • \$12.50

SOLID STATE ELECTRONICS • ROBERT G. HIBBERD

170 Pages • 90 Illustrations • Published January '68 •
Shipping Weight 1-lb 12-oz • \$8.95

Terms: F.O.B. destination, bulk rate.

Other than bulk rate,
indicate method of shipment,
add shipping charges.

Outside U.S.: Indicate method of shipment,
add shipping charges.

Send check or money order
(no purchase orders) to:

EXECUTIVE SERVICES DISTRIBUTION
Suite 148
8383 Stemmons Freeway
Dallas, Texas 75247

TYPE 2N3819 N-CHANNEL PLANAR SILICON FIELD-EFFECT TRANSISTOR



TYPE 2N3819
BULLETIN NO. DL-5-688047, AUGUST 1965
REVISED MAY 1968

SILECT[†] FIELD-EFFECT TRANSISTOR

For Industrial and Consumer Small-Signal Applications

- Low $C_{RSS} \leq 4$ pf • High y_{fs}/C_{ISS} Ratio (High-Frequency Figure of Merit)
- Cross Modulation Minimized by Square-Law Transfer Characteristics

mechanical data

This transistor is encapsulated in a plastic compound specifically designed for this purpose, using a highly mechanized process[‡] developed by Texas Instruments. The case will withstand soldering temperatures without deformation. This device exhibits stable characteristics under high-humidity conditions and is capable of meeting MIL-STD-202C method 106B. The transistor is insensitive to light.

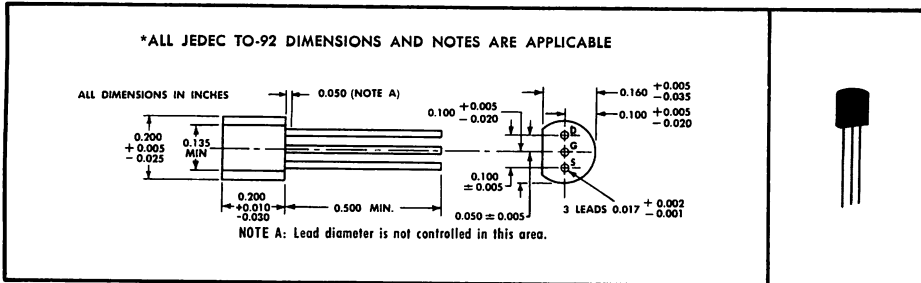

*absolute maximum ratings at 25°C free-air temperature (unless otherwise noted)

Drain-Gate Voltage	25 v
Drain-Source Voltage	25 v
Reverse Gate-Source Voltage	-25 v
Gate Current	10 ma
Continuous Device Dissipation at (or below) 25°C Free-Air Temperature (See Note 1)	360 mw
Storage Temperature Range	-65°C to 150°C
Lead Temperature 1/8 Inch from Case for 10 Seconds	260°C

*electrical characteristics at 25°C free-air temperature (unless otherwise noted)

PARAMETER	TEST CONDITIONS	MIN	MAX	UNIT
$V_{(BR)GSS}$ Gate-Source Breakdown Voltage	$I_G = -1 \mu a, V_{DS} = 0$	-25		v
I_{GSS} Gate Cutoff Current	$V_{GS} = -15 v, V_{DS} = 0$		-2	na
	$V_{GS} = -15 v, V_{DS} = 0, T_A = 100^\circ C$		-2	μa
I_{DSS} Zero-Gate-Voltage Drain Current	$V_{DS} = 15 v, V_{GS} = 0$, See Note 2	2	20	ma
V_{GS} Gate-Source Voltage	$V_{DS} = 15 v, I_D = 200 \mu a$	-0.5	-7.5	v
$V_{GS(off)}$ Gate-Source Cutoff Voltage	$V_{DS} = 15 v, I_D = 2 na$		-8	v
$ y_{fs} $ Small-Signal Common-Source Forward Transfer Admittance	$V_{DS} = 15 v, V_{GS} = 0, f = 1 kc$, See Note 2	2000	6500	μmho
$ y_{os} $ Small-Signal Common-Source Output Admittance	$V_{DS} = 15 v, V_{GS} = 0, f = 1 kc$, See Note 2		50	μmho
C_{ISS} Common-Source Short-Circuit Input Capacitance	$V_{DS} = 15 v, V_{GS} = 0,$		8	pf
		$f = 1 Mc$	4	pf
$ y_{fs} $ Small-Signal Common-Source Forward Transfer Admittance	$V_{DS} = 15 v, V_{GS} = 0, f = 100 Mc$	1600		μmho

NOTES: 1. Derate linearly to 150°C free-air temperature at the rate of 2.88 mw/C°.

2. These parameters must be measured using pulse techniques. PW ≈ 100 msec, Duty Cycle ≤ 10%.

*Indicates JEDEC registered data.

†Trademark of Texas Instruments

‡Patent Pending



TEXAS INSTRUMENTS
INCORPORATED
POST OFFICE BOX 5012 • DALLAS, TEXAS 75222

AUTHORIZED DISTRIBUTORS

FOR TEXAS INSTRUMENTS COMPONENTS GROUP

ALABAMA

ACK SEMICONDUCTORS INC.
3101 Fourth Ave. South/(205) FA 2-0588
Birmingham, Alabama 35233

ELECTRONIC WHOLESALERS, INC.
2310 Bob Wallace Avenue, S.W.
(205) 534-2461
Huntsville, Alabama 35805

ARIZONA

KIERULFF ELECTRONICS, INC.
2633 East Buckeye Road
(602) 273-7331
Phoenix, Arizona 85034

R. V. WEATHERFORD COMPANY
1917 North 25 Drive/(602) 272-7144
Carson Industrial Center
Phoenix, Arizona

CALIFORNIA

CALIFORNIA ELECTRONICS SUPPLY, INC.
1911 Armacost Avenue/(213) TR 9-0760
West Los Angeles, California 90025

KIERULFF ELECTRONICS, INC.
3969 E. Bayshore/(415) 968-6292
Palo Alto, California 94303

MILO OF CALIFORNIA
2060 India St./(714) BE 2-8951
San Diego, California 92101

RADIO PRODUCTS SALES, INC.
1501 S. Hill St./(213) RI 8-1271
Los Angeles, California 90015

R. V. WEATHERFORD COMPANY
1651 S. State College Blvd.
(714) KI 7-7521
Anaheim, California 92805

6921 San Fernando Rd./(213) VI 9-3451
Glendale, California 91201
3240 Hillview Drive
Stanford Industrial Park
(415) DA 1-5373
Palo Alto, California 94304

TI SUPPLY COMPANY

1651 Tenth Street/(213) 393-6731
Santa Monica, California 90404

COLORADO

TI SUPPLY COMPANY
2186 S. Holly/(303) 757-7671
Denver, Colorado 80222

FLORIDA

ELECTRONIC WHOLESALERS, INC.
345 Graham Ave./(305) 841-1550
Orlando, Florida 32814

9390 N. W. 27th Ave./(305) OX 6-1620
Miami, Florida 33147

ILLINOIS

ALLIED ELECTRONICS CORPORATION
100 N. Western Ave./(312) TA 9-9100
Chicago, Illinois 60680

MERQUIP ELECTRONICS, INC.
7701 No. Austin Ave./(312) 965-7500
Skokie, Illinois 60076

NEWARK ELECTRONICS CORP.
500 N. Pulaski Road/(312) 638-4411
Chicago, Illinois 60624

TI SUPPLY COMPANY
7135 N. Barry Avenue/(312) 296-7187
Des Plaines, Illinois 60018

INDIANA

ESCO ELECTRONICS INC.
2442 N. Shadeland Ave./(317) 357-8791
Indianapolis, Indiana 46219

RADIO DISTRIBUTING COMPANY
814 North Senate Avenue
(317) 637-5571
Indianapolis, Indiana 46204

IOWA

DEECO, INC.
618 First St., N. W./(319) EM 5-7551
Cedar Rapids, Iowa 52405

LOUISIANA

ELECTRONIC PRODUCTS CORPORATION
3622 Toulouse St./(504) HU 6-3777
New Orleans, Louisiana 70119

MARYLAND

ELECTRONIC WHOLESALERS, INC.
3200 Wilkens Ave./(301) 646-3600
Baltimore, Maryland 21223

MILGRAY/WASHINGTON
5405 Lafayette Place/(202) 864-1111
Hyattsville, Maryland 20781

MASSACHUSETTS

DEMAMBRO ELECTRONICS
1095 Commonwealth Ave.
(617) 787-1200
Boston, Massachusetts 02215

TI SUPPLY COMPANY
480 Neponset Road/(617) 828-5020
Canton, Massachusetts 02021

LAFAYETTE INDUSTRIAL ELECTRONICS
1400 Worcester Rd./(617) 969-6100
Natick, Massachusetts 01760

MILGRAY/NEW ENGLAND INC.
75 Terrace Hall Avenue/(617) 272-6800
Burlington, Massachusetts 02021

MICHIGAN

NEWARK-DETROIT ELECTRONICS, INC.
20700 Hubbell Ave./(313) 548-0250
Detroit, Michigan 48237

NEWARK-INDUSTRIAL
ELECTRONICS CORP.
2114 So. Division/(616) CH 1-5695
Grand Rapids, Michigan 49507

MINNESOTA

STARK ELECTRONIC SUPPLY CO.
112 Third Avenue N/(612) FE 2-1325
Minneapolis, Minnesota 55401

MISSOURI

TI SUPPLY COMPANY
2916 Holmes Street/(816) 753-4750
Kansas City, Missouri 64109

ELECTRONIC COMPONENTS FOR
INDUSTRY
2605 South Hanley Rd./(314) MI 7-5505
St. Louis, Missouri 63144

NEW JERSEY

GENERAL RADIO SUPPLY COMPANY, INC.
600 Penn St./(609) WO 4-8560
Camden, New Jersey 08102

TI SUPPLY COMPANY
301 Central Ave./(201) 382-6400
Clark, N. J. 07066

NEW MEXICO

KIERULFF ELECTRONICS, INC.
2524 Baylor Dr. S.E./(505) 247-1055
Albuquerque, New Mexico 87108

NEW YORK

GENESEE RADIO & PARTS CO., INC.
2550 Delaware Ave./(716) TR 3-9661
Buffalo, New York 14216

LAFAYETTE INDUSTRIAL ELECTRONICS
165-08 Liberty Ave./(212) 658-5050
Jamaica, New York 11431

MILGRAY/NEW YORK
160 Varick St./(212) YU 9-1600
New York, New York 10013

ROCHESTER RADIO SUPPLY CO., INC.
140 W. Main St./(716) 454-7800
Rochester, New York 14614

TI SUPPLY COMPANY
4 Nevada Dr./(516) 488-3300
New Hyde Park, L. I., N. Y. 11040

NORTH CAROLINA

ELECTRONIC WHOLESALERS, INC.
938 Burke St./(919) PA 5-8711
Winston-Salem, North Carolina 27101

OHIO

ESCO ELECTRONICS INC.
3130 Valleywood Drive/(513) 298-0191
Dayton, Ohio 45429

MILGRAY/CLEVELAND
1821 East 40th Street/(216) 881-8800
Cleveland, Ohio 44102

NEWARK-HERRLINGER
ELECTRONICS CORP.
112 E. Liberty St./(513) GA 1-5282
Cincinnati, Ohio 45210

W. M. PATTISON SUPPLY CO.
4550 Willow Parkway/(216) 441-3000
Cleveland, Ohio 44125

SREPCO ELECTRONICS, INC.
314 Leo Street/(513) BA 4-3871
Dayton, Ohio 45404

OKLAHOMA

TI SUPPLY COMPANY
12151 E. Skelly Dr./(918) 437-4555
Tulsa, Oklahoma 74110

OREGON

ALMAC STROUM ELECTRONICS
CORPORATION
8888 S.W. Canyon Road/(503) 292-3534
Portland, Oregon 97225

PENNSYLVANIA

MILGRAY/DELAWARE VALLEY INC.
2532 N. Broad St./(215) BA 8-2000
Philadelphia, Penn. 19107

RPC ELECTRONICS
620 Alpha Dr./(412) 782-3770
RIDC Park
Pittsburgh, Pennsylvania 15238

TEXAS

TI SUPPLY COMPANY
6000 Denton Drive/(214) FL 7-6121
Dallas, Texas 75235

5240 Elm Street/(713) MO 6-2175
Houston, Texas 77036

HARRISON EQUIPMENT COMPANY, INC.
1422 San Jacinto St./(713) CA 4-9131
Houston, Texas 77001

MIDLAND SPECIALTY COMPANY
2235 Wyoming Ave./(915) KE 3-9555
El Paso, Texas 79903

UTAH

STANDARD SUPPLY COMPANY
225 E. Sixth South St./(801) EL 5-2971
Salt Lake City, Utah 84110

WASHINGTON

ALMAC-STROUM ELECTRONICS
5811 Sixth Ave. So./(206) 763-2300
Seattle, Washington 98108

WASHINGTON, D.C.

ELECTRONIC WHOLESALERS, INC.
2345 Sherman Ave., N. W.
(202) HU 3-5200
Washington, D.C. 20001

CANADA

CANADIAN ELECTRONICS LTD.
Calgary, Alberta
Edmonton, Alberta
Lethbridge, Alberta
Medicine Hat, Alberta
Vancouver, B. C.

CESCO ELECTRONICS LTD.
Downsview, Quebec
Quebec, Quebec
Ottawa, Ontario
Toronto, Ontario

TI SUPPLY COMPANY

Drval, Quebec

WELLINGTON, New Zealand

W. G. LEATHAM LTD.

AUSTRALIAN TI DISTRIBUTOR

MELBOURNE, Australia
RADIO PARTS PTY, LTD.
PERTH, Australia
PRECISION ELECTRONICS
BRISBANE, Australia
DOUGLAS ELECTRONICS

EUROPEAN TI DISTRIBUTORS

BRUSSELS IV, Belgium
S.A. AVI-ELEC N.V.

COPENHAGEN V, Denmark
TEXAS INSTRUMENTS A/S

HELSINKI, Finland

OY CHESTER AB

HAMBURG, West Germany
FIRMA ALFRED NEYE, ENATECHNIK

STUTTART, WEST GERMANY

TI SUPPLY CO.

OSLO, Norway

MORGENSTIERNE & CO.

STOCKHOLM, Sweden

AB GOSTA BACKSTROM

ZURICH 32, Switzerland

FABRIMEX AG ZURICH

PARIS, FRANCE

TI SUPPLY CO.

MILANO, ITALY

TI SUPPLY CO.

MANCHESTER, ENGLAND

TI SUPPLY CO.

TYPE 2N3820 P-CHANNEL PLANAR SILICON FIELD-EFFECT TRANSISTOR



TYPE 2N3820
 BULLETIN NO. DL-5 687947, AUGUST 1965
 REVISED JULY 1968

SILECT[†] FIELD-EFFECT TRANSISTOR For Industrial and Consumer Small-Signal Applications

mechanical data

This transistor is encapsulated in a plastic compound specifically designed for this purpose, using a highly mechanized process[‡] developed by Texas Instruments. The case will withstand soldering temperatures without deformation. This device exhibits stable characteristics under high-humidity conditions and is capable of meeting MIL-STD-202C method 106B. The transistor is insensitive to light.

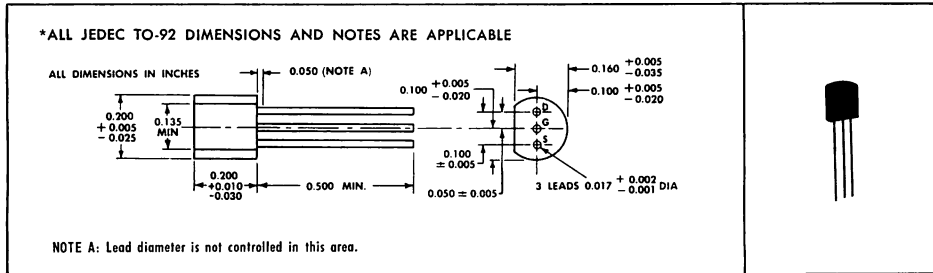

* absolute maximum ratings at 25°C free-air temperature (unless otherwise noted)

Drain-Gate Voltage	-20 v
Drain-Source Voltage	-20 v
Reverse Gate-Source Voltage	20 v
Gate Current	-10 ma
Continuous Device Dissipation at (or below) 25°C Free-Air Temperature (See Note 1)	360 mw
Storage Temperature Range	-65°C to +150°C
Lead Temperature $\frac{1}{16}$ Inch from Case for 10 Seconds	260°C

* electrical characteristics at 25°C free-air temperature (unless otherwise noted)

PARAMETER	TEST CONDITIONS	MIN	MAX	UNIT
$V_{(BR)GS}$ Gate-Source Breakdown Voltage	$I_G = 10 \mu\text{A}$, $V_{DS} = 0$	20		v
I_{GSS} Gate Cutoff Current	$V_{GS} = 10 \text{ v}$, $V_{DS} = 0$		20	na
	$V_{GS} = 10 \text{ v}$, $V_{DS} = 0$, $T_A = 100^\circ\text{C}$		2	μA
I_{DSS} Zero-Gate-Voltage Drain Current	$V_{DS} = -10 \text{ v}$, $V_{GS} = 0$, See Note 2	-0.3	-15	ma
V_{GS} Gate-Source Voltage	$V_{DS} = -10 \text{ v}$, $I_D = -30 \mu\text{A}$	0.3	7.9	v
$V_{GS(off)}$ Gate-Source Cutoff Voltage	$V_{DS} = -10 \text{ v}$, $I_D = -10 \mu\text{A}$		8	v
$ y_{fs} $ Small-Signal Common-Source Forward Transfer Admittance	$V_{DS} = -10 \text{ v}$, $V_{GS} = 0$, $f = 1 \text{ kc}$, See Note 2	800	5000	μmho
$ y_{os} $ Small-Signal Common-Source Output Admittance	$V_{DS} = -10 \text{ v}$, $V_{GS} = 0$, $f = 1 \text{ kc}$, See Note 2		200	μmho
C_{iss} Common-Source Short-Circuit Input Capacitance	$V_{DS} = -10 \text{ v}$, $V_{GS} = 0$		32	pf
C_{rss} Common-Source Short-Circuit Reverse Transfer Capacitance	$f = 1 \text{ Mc}$		16	pf
$ y_{fs} $ Small-Signal Common-Source Forward Transfer Admittance	$V_{DS} = -10 \text{ v}$, $V_{GS} = 0$, $f = 10 \text{ Mc}$	700		μmho

NOTES: 1. Derate linearly to 150°C free-air temperature at the rate of 2.88 mw/°C.
 2. These parameters must be measured using pulse techniques. $PW \approx 100 \text{ msec}$, Duty Cycle $\leq 10\%$.

*Indicates JEDEC registered data.
[†]Trademark of Texas Instruments
[‡]Patent Pending



TEXAS INSTRUMENTS
 INCORPORATED
 POST OFFICE BOX 5012 • DALLAS, TEXAS 75222

TI World-Wide Sales Offices

ALABAMA

Sahara Office Park Bldg., Suite 111
3313 Memorial Parkway, S.W.
Huntsville, Alabama 35801
205-881-4061

ARIZONA

2535 W. Camelback Rd., Suite 1D
Phoenix, Arizona 85017
602-279-5531

CALIFORNIA

1800 North Argyle Ave.
Hollywood, California 90028
213-466-7251

5005 West Century Blvd., Suite 208
Inglewood, California 90301
213-673-3943

230 California Ave., Suite 201
Palo Alto, California 94306
415-326-6770

1505 East 17th St., Suite 201
Santa Ana, California 92701
714-547-6506

4185 Adams Ave.
San Diego, California 92116
714-284-1181

COLORADO

2186 South Holly St., Suite 204
Denver, Colorado 80222
303-757-8548

CONNECTICUT

300 Amity Road
Woodbridge, Connecticut 06525
203-389-4521

FLORIDA

618 East South St., Suite 114
Orlando, Florida 32801
305-422-9894

ILLINOIS

Suite 205, Executive Towers
5901 N. Cicero Ave.
Chicago, Illinois 60646
312-286-1000

MASSACHUSETTS

60 Hickory Drive
Waltham, Mass. 02154
617-891-8450

MICHIGAN

Suite 706 West, Northland Towers Bldg.
15565 Northland Dr.
Southfield, Michigan 48075
313-357-1703

MINNESOTA

7615 Metro Blvd.
Suite 202, U.C.L.I. Bldg.
Edina, Minn. 55424
612-941-4384

NEW JERSEY

U.S. Highway #22
P.O. Box 366
Union, New Jersey 07083
201-687-7200

NEW YORK

P. O. Box 87, 2209 E. Main
Endicott, New York 13760
607-785-9987

4 Nevada Drive
New Hyde Park, N. Y. 11040
516-488-9894

131 Fulton Ave., Apt. J-2
Poughkeepsie, New York 12603
914-471-6095

OHIO

22035 Chagrin Blvd.
Cleveland, Ohio 44122
216-751-2600

Suite 205, Paul Welch Bldg.
3300 South Dixie Dr.
Dayton, Ohio 45439
513-298-7513

PENNSYLVANIA

Benjamin Fox Pavilion
Suite 424, Foxcroft Square
Jenkintown, Pa. 19046
215-885-3454

TEXAS

MS80 — P.O. Box 5012
Dallas, Texas 75222
214-238-4861

3609 Buffalo Speedway
Houston, Texas 77006
713-526-3268

WASHINGTON

5801 Sixth Ave. S.
Seattle, Washington 98108
206-762-4240

WASHINGTON, D.C.

1875 Connecticut Ave., N.W., Suite 913
Washington, D.C. 20009
202-234-9320

CANADA

Geophysical Service Incorporated
280 Centre Str. East
Richmond Hills
Ontario, Canada
925-1035

663 Orly Avenue
Dorval
Quebec, Canada
631-6010

EUROPE

Texas Instruments Limited
Manton Lane
Bedford, England

Texas Instruments France S. A.
Boite Postale 5
Villeneuve-Loubet (A.M.), France

11 rue de Madrid
Paris 8°, France

Texas Instruments Holland N.V.
Semiconductor Division
Enschedeestraat 19
Hengelo (Ov), Holland

Texas Instruments Italia S.p.A.
Via Colautti 1
Milan, Italy

Texas Instruments Incorporated
118 Rue du Rhone
1204 Geneva, Switzerland

Texas Instruments Sweden A.B.
Timmermangatan 34, Box 17116
Stockholm 17, Sweden

Texas Instruments Deutschland GmbH
Hildesheimerstr. 19
3 Hannover, W. Germany

Texas Instruments Deutschland GmbH
Wolframstrasse 26
7 Stuttgart
West Germany

Texas Instruments Deutschland GmbH
Clemensstrasse 30
8 Munich 23
West Germany

Texas Instruments Deutschland GmbH
Kepserstrasse 33
805 Freising-Lerchenzeid
West Germany

Texas Instruments Deutschland GmbH
Koenigsbacherstrasse 22
6 Frankfurt, West Germany

MEXICO

Texas Instruments de Mexico S.A.
Poniente 116 #489
Col. Ind. Vallejo
Mexico 15, D.F.

ARGENTINA

Texas Instruments Argentina S.A.I.C.F.
(P. O. Box 2296 — Correo Central)
Ruta Panamericana Km. 13, 5
Don Torcuato
Buenos Aires, Argentina

BRAZIL

Texas Instrumentos Electronicos
do Brazil Ltda.
Rua Casario Alvim 770
Caixa Postal 30.103
Sao Paulo 6, Brazil

AUSTRALIA

Texas Instruments Australia Ltd.
Box 63, Oldham Road
Elizabeth, South Australia

Texas Instruments Australia Ltd.
Room 5, Rural Bank Bldg.
Burwood, N.S.W., Australia

JAPAN

Texas Instruments Asia Limited
404 T.B.R. Building
No. 59, 2-chome, Nagata-cho
Chiyo-da, Tokyo, Japan

TYPES 2N3821, 2N3822 N-CHANNEL EPITAXIAL PLANAR SILICON FIELD-EFFECT TRANSISTORS



TYPES 2N3821, 2N3822
BULLETIN NO. DLS-657246, MARCH 1965

SYMMETRICAL N-CHANNEL FIELD-EFFECT TRANSISTORS FOR SMALL-SIGNAL APPLICATIONS

- Low Leakage: $\leq 100 \text{ pa}$
- Low Input Capacitance: $\leq 6 \text{ pf}$
- High y_{fs}/C_{iss} Ratio (High-Frequency Figure-of-Merit)

*mechanical data

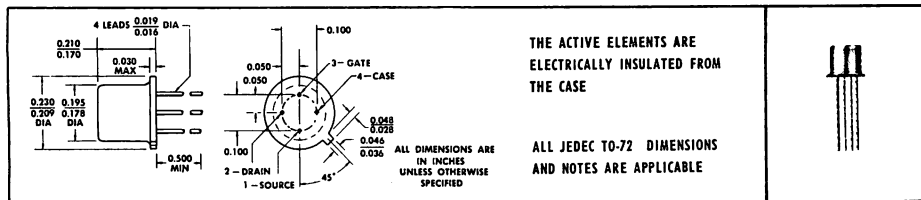

TO-72 outline is same as TO-18 outline with the addition of a fourth lead.

* absolute maximum ratings at 25°C free-air temperature (unless otherwise noted)

Drain-Gate Voltage	50 v
Drain-Source Voltage	50 v
Reverse Gate-Source Voltage	-50 v
Gate Current	10 ma
Continuous Device Dissipation at (or below) 25°C Free-Air Temperature (See Note 1)	300 mw
Storage Temperature Range	-65°C to +200°C
Lead Temperature $\frac{1}{16}$ Inch from Case for 10 Seconds	300°C

* electrical characteristics at 25°C free-air temperature (unless otherwise noted)

PARAMETER	TEST CONDITIONS†	2N3821		2N3822		UNIT
		MIN	MAX	MIN	MAX	
$V_{(BR)GSS}$ Gate-Source Breakdown Voltage	$I_G = -1 \mu\text{a}$, $V_{DS} = 0$	-50		-50		v
I_{GSS} Gate Cutoff Current	$V_{GS} = -30 \text{ v}$, $V_{DS} = 0$		-0.1		-0.1	na
	$V_{GS} = -30 \text{ v}$, $V_{DS} = 0$, $T_A = 150^\circ\text{C}$		-0.1		-0.1	μa
I_{DSS} Zero-Gate-Voltage Drain Current	$V_{DS} = 15 \text{ v}$, $V_{GS} = 0$, See Note 2	0.5	2.5	2	10	ma
V_{GS} Gate-Source Voltage	$V_{DS} = 15 \text{ v}$, $I_D = 50 \mu\text{a}$	-0.5	-2			v
	$V_{DS} = 15 \text{ v}$, $I_D = 200 \mu\text{a}$			-1	-4	v
$V_{GS(off)}$ Gate-Source Cutoff Voltage	$V_{DS} = 15 \text{ v}$, $I_D = 0.5 \text{ na}$		-4		-6	v
$ y_{fs} $ Small-Signal Common-Source Forward Transfer Admittance	$V_{DS} = 15 \text{ v}$, $V_{GS} = 0$, $f = 1 \text{ kc}$ See Note 2	1500	4500	3000	6500	μmho
$ y_{os} $ Small-Signal Common-Source Output Admittance	$V_{DS} = 15 \text{ v}$, $V_{GS} = 0$, $f = 1 \text{ kc}$ See Note 2		10		20	μmho
C_{iss} Common-Source Short-Circuit Input Capacitance	$V_{DS} = 15 \text{ v}$, $V_{GS} = 0$,		6		6	pf
C_{rss} Common-Source Short-Circuit Reverse Transfer Capacitance	$f = 1 \text{ Mc}$		3		3	pf
$ y_{fs} $ Small-Signal Common-Source Forward Transfer Admittance	$V_{DS} = 15 \text{ v}$, $V_{GS} = 0$, $f = 100 \text{ Mc}$	1500		3000		μmho

NOTES: 1. Derate linearly to 175°C free-air temperature at the rate of 2 mw/°C.

2. These parameters must be measured using pulse techniques. PW = 100 msec, Duty Cycle $\leq 10\%$.

†The fourth lead (case) is connected to the source for all measurements.

*Indicates JEDEC registered data



TEXAS INSTRUMENTS
INCORPORATED
POST OFFICE BOX 5012 • DALLAS, TEXAS 75222

TYPES 2N3821, 2N3822

N-CHANNEL EPITAXIAL PLANAR SILICON FIELD-EFFECT TRANSISTORS

*operating characteristics at 25°C free-air temperature

PARAMETER	TEST CONDITIONS†	MAX	UNIT
\overline{NF} Average Noise Figure	$V_{DS}=15\text{ v}$, $V_{GS}=0$, $f=10\text{ cps}$, $R_G=1\text{ M}\Omega$, Noise Bandwidth=5 cps	5	db
e_n Equivalent Input Noise Voltage	$V_{DS}=15\text{ v}$, $V_{GS}=0$, $f=10\text{ cps}$, Noise Bandwidth=5 cps	200	$\text{nv}/\text{cps}^{1/2}$

†The fourth lead (case) is connected to the source for all measurements.

THERMAL INFORMATION

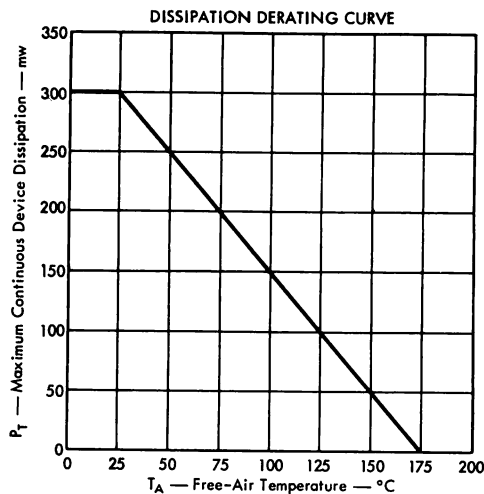

*Indicates JEDEC registered data.

TYPE 2N3823 N-CHANNEL EPITAXIAL PLANAR SILICON FIELD-EFFECT TRANSISTOR



TYPE 2N3823
BULLETIN NO. DL-5 657816, JULY 1965

SYMMETRICAL N-CHANNEL FIELD-EFFECT TRANSISTOR FOR VHF AMPLIFIER AND MIXER APPLICATIONS

- Low Noise Figure: ≤ 2.5 db at 100 Mc
- Low C_{rss} : ≤ 2 pf
- High y_{fs}/C_{iss} Ratio (High-Frequency Figure-of-Merit)
- Cross Modulation Minimized by Square-Law Transfer Characteristic

***mechanical data**

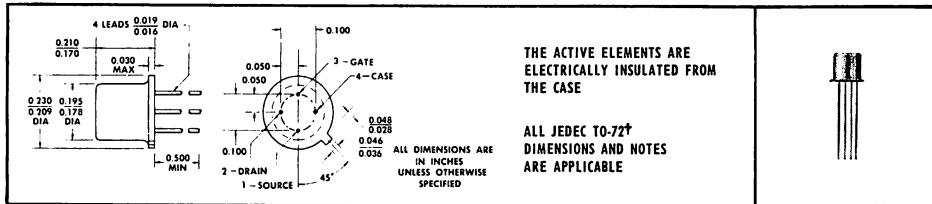

†TO-72 outline is same as TO-18 except for addition of a fourth lead.

*** absolute maximum ratings at 25°C free-air temperature (unless otherwise noted)**

Drain-Gate Voltage	30 v
Drain-Source Voltage	30 v
Reverse Gate-Source Voltage	-30 v
Gate Current	10 ma
Continuous Device Dissipation at (or below) 25°C Free-Air Temperature (See Note 1)	300 mw
Storage Temperature Range	-65°C to + 200°C
Lead Temperature 1/8 Inch from Case for 10 Seconds	300°C

*** electrical characteristics at 25°C free-air temperature (unless otherwise noted)**

PARAMETER	TEST CONDITIONS†	MIN	MAX	UNIT
$V_{(BR)GSS}$ Gate-Source Breakdown Voltage	$I_G = -1 \mu a, V_{DS} = 0$	-30		v
I_{GSS} Gate Cutoff Current	$V_{GS} = -20 v, V_{DS} = 0$		-0.5	na
	$V_{GS} = -20 v, V_{DS} = 0, T_A = 150^\circ C$		-0.5	μa
I_{DSS} Zero-Gate-Voltage Drain Current	$V_{DS} = 15 v, V_{GS} = 0, \text{ See Note 2}$	4	20	ma
V_{GS} Gate-Source Voltage	$V_{DS} = 15 v, I_D = 400 \mu a$	-1	-7.5	v
$V_{GS(off)}$ Gate-Source Cutoff Voltage	$V_{DS} = 15 v, I_D = 0.5 na$		-8	v
$ y_{fs} $ Small-Signal Common-Source Forward Transfer Admittance	$V_{DS} = 15 v, V_{GS} = 0, f = 1 kc, \text{ See Note 2}$	3500	6500	μmho
$ y_{os} $ Small-Signal Common-Source Output Admittance	$V_{DS} = 15 v, V_{GS} = 0, f = 1 kc, \text{ See Note 2}$		35	μmho
C_{iss} Common-Source Short-Circuit Input Capacitance	$V_{DS} = 15 v, V_{GS} = 0, f = 1 Mc$		6	pf
			2	pf
$ y_{fs} $ Small-Signal Common-Source Forward Transfer Admittance	$V_{DS} = 15 v, V_{GS} = 0, f = 200 Mc$		3200	μmho
$Re(y_{is})$ Small-Signal Common-Source Input Conductance			800	μmho
$Re(y_{os})$ Small-Signal Common-Source Output Conductance			200	μmho

NOTES: 1. Derate linearly to 175°C free-air temperature at the rate of 2 mw/C°.
 2. These parameters must be measured using pulse techniques. PW = 100 msec, Duty Cycle $\leq 10\%$.

†Indicates JEDEC registered data.

‡The fourth lead (case) is connected to the source for all measurements.

TYPE 2N3823

N-CHANNEL EPITAXIAL PLANAR SILICON FIELD-EFFECT TRANSISTOR

* operating characteristics at 25°C free-air temperature

PARAMETER	TEST CONDITIONS†	MAX	UNIT
NF	Common-Source Spot Noise Figure	2.5	db

TYPICAL CHARACTERISTICS‡

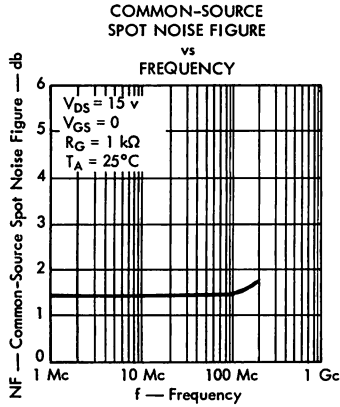

FIGURE 1

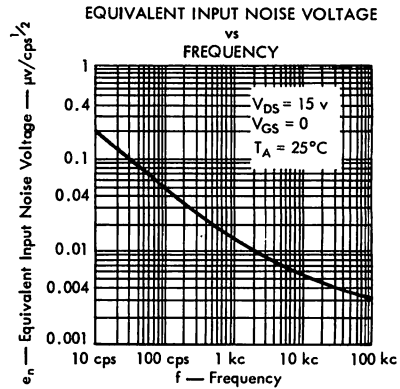

FIGURE 2

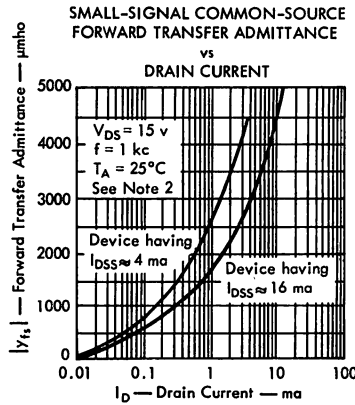

FIGURE 3

NOTE 2: These parameters must be measured using pulse techniques. PW = 100 msec, Duty Cycle \leq 10%.

*Indicates JEDEC registered data.

†The fourth lead (case) is connected to the source for all measurements.

TYPE 2N3823 N-CANNEL EPITAXIAL PLANAR SILICON FIELD-EFFECT TRANSISTOR

TYPICAL CHARACTERISTICS†

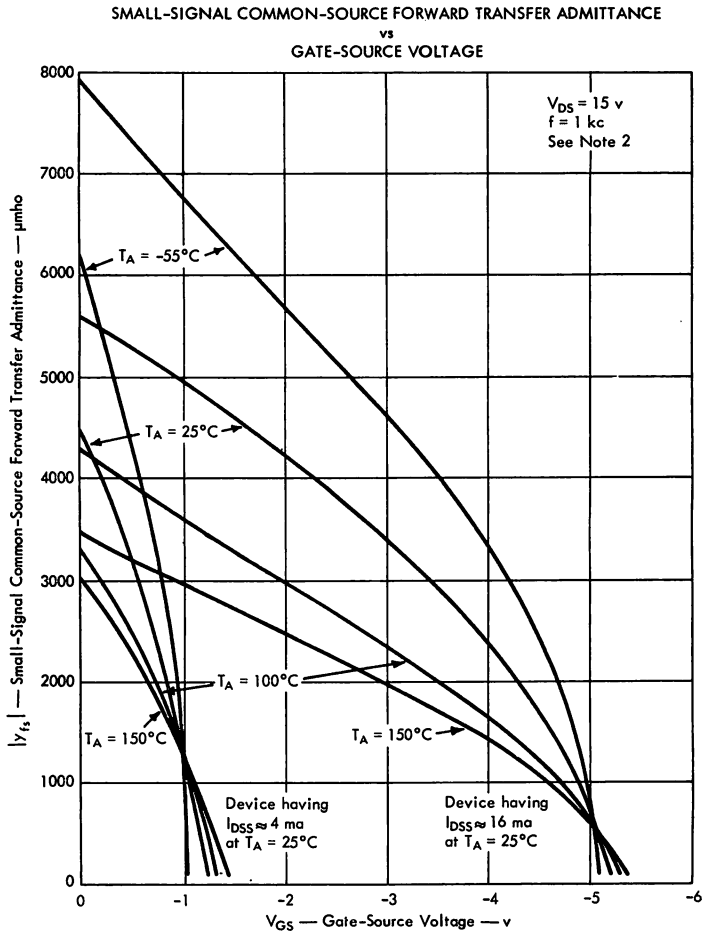

FIGURE 4

NOTE 2: These parameters must be measured using pulse techniques. PW = 100 msec, Duty Cycle \leq 10%.

†The fourth lead (case) is connected to the source for all measurements.

TYPE 2N3823

N-CHANNEL EPITAXIAL PLANAR SILICON FIELD-EFFECT TRANSISTOR

TYPICAL CHARACTERISTICS†

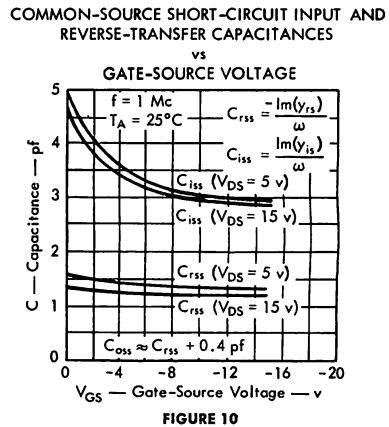
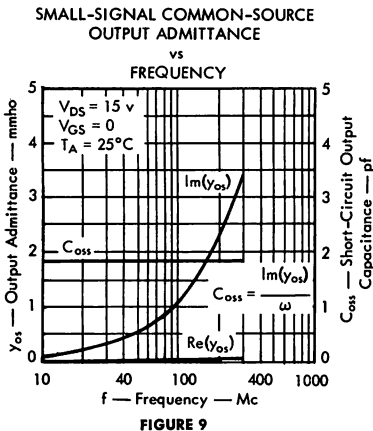
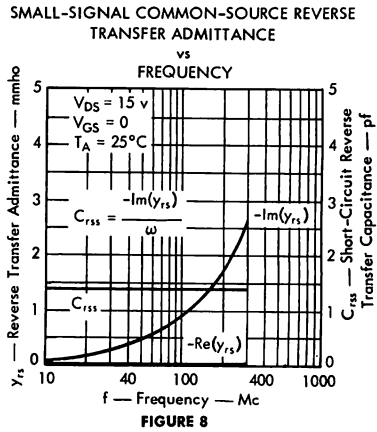
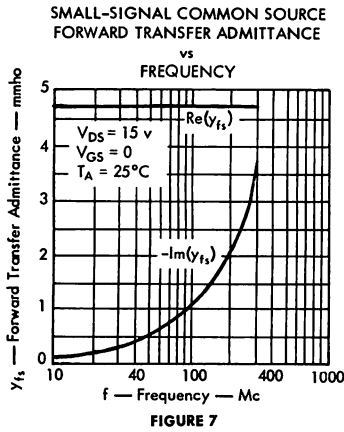
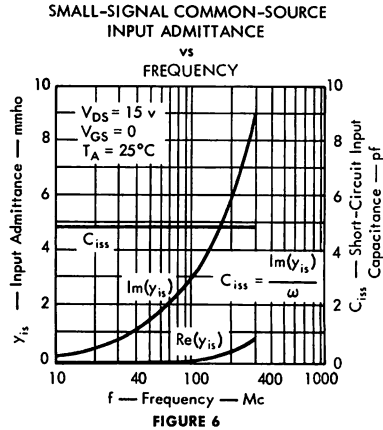
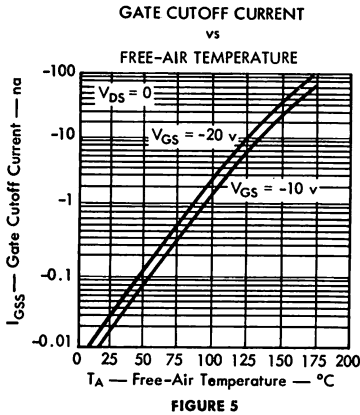

†The fourth lead (case) is connected to the source for all measurements.

TYPE 2N3909 P-CHANNEL PLANAR SILICON FIELD-EFFECT TRANSISTOR



TYPE 2N3909
BULLETIN NO. DLS-657690, JUNE 1965

FOR INDUSTRIAL SMALL-SIGNAL APPLICATIONS

- Electrically Similar to 2N2386
- TO-72 Case Outline
- Active Elements Insulated From Case

*mechanical data

4 LEADS 0.012 DIA
0.210
0.170
0.030 MAX
0.230 DIA
0.105 DIA
0.209 DIA
0.500 MIN
0.100
0.050
0.050
3 - DRAIN
4 - CASE
0.058
0.028
0.046
0.036
45°
2 - GATE
1 - SOURCE

ALL DIMENSIONS ARE IN INCHES UNLESS OTHERWISE SPECIFIED

THE ACTIVE ELEMENTS ARE ELECTRICALLY INSULATED FROM THE CASE

ALL JEDEC TO-72 † DIMENSIONS AND NOTES ARE APPLICABLE

†TO-72 outline is same as TO-18 outline, except for fourth lead.

*absolute maximum ratings at 25°C free-air temperature (unless otherwise noted)

Drain-Gate Voltage	-20 v
Drain-Source Voltage	-20 v
Reverse Gate-Source Voltage	20 v
Gate Current	-10 ma
Continuous Device Dissipation at (or below) 25°C Free-Air Temperature (See Note 1)	300 mw
Storage Temperature Range	-65°C to +200°C
Lead Temperature 1/8 Inch from Case for 10 Seconds	300°C

*electrical characteristics at 25°C free-air temperature (unless otherwise noted)

PARAMETER	TEST CONDITIONS ‡	MIN	MAX	UNIT
$V_{(BR)GSS}$ Gate-Source Breakdown Voltage	$I_G = 10 \mu a, V_{DS} = 0$	20		v
I_{GSS} Gate Cutoff Current	$V_{GS} = 10 v, V_{DS} = 0$		10	na
	$V_{GS} = 10 v, V_{DS} = 0, T_A = 100^\circ C$		1	μa
I_{DSS} Zero-Gate-Voltage Drain Current	$V_{DS} = -10 v, V_{GS} = 0$	-0.3	-15	ma
V_{GS} Gate-Source Voltage	$V_{DS} = -10 v, I_D = -30 \mu a$	0.3	7.9	v
$V_{GS(off)}$ Gate-Source Cutoff Voltage	$V_{DS} = -10 v, I_D = -10 \mu a$		8	v
$ y_{fs} $ Small-Signal Common-Source Forward Transfer Admittance	$V_{DS} = -10 v, V_{GS} = 0,$ $f = 1 kc$	1000	5000	μmho
		100		μmho
C_{iss} Common-Source Short-Circuit Input Capacitance	$V_{DS} = -10 v, V_{GS} = 0,$ $f = 1 Mc$		32	pf
			16	pf
$ y_{fs} $ Small-Signal Common-Source Forward Transfer Admittance	$V_{DS} = -10 v, V_{GS} = 0, f = 10 Mc$	900		μmho

NOTE 1: Derate linearly to 175°C free-air temperature at the rate of 2 mw/°C.

‡ The fourth lead (case) is connected to the source for all measurements.

*Indicates JEDEC registered data.



TI Microlibrary Books for Creative Circuit Designers

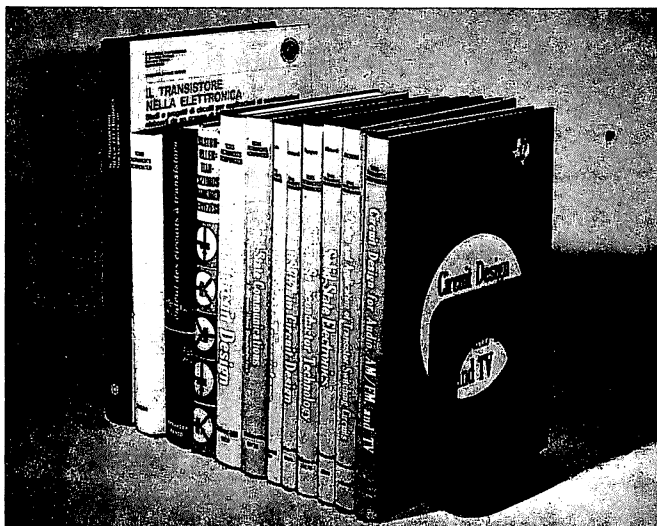

TRANSISTOR CIRCUIT DESIGN

523 Pages • 526 Illustrations • Published January '63 •
Shipping Weight 3-lb 4 oz • \$15.00

FIELD-EFFECT TRANSISTORS • L. J. SEVIN

138 Pages • 137 Illustrations • Published April '65 •
Shipping Weight 1-lb 10-oz • \$10.00

MOSFET IN CIRCUIT DESIGN • ROBERT H. CRAWFORD

136 Pages • 100 Illustrations • Published May '67 •
Shipping Weight 1-lb 10-oz • \$10.00

CIRCUIT DESIGN FOR AUDIO, AM/FM AND TV

352 Pages • 145 Illustrations • Published February '67 •
Shipping Weight 2-lb 8-oz • \$14.50

SILICON SEMICONDUCTOR TECHNOLOGY • W. R. RUNYAN

256 Pages • 301 Illustrations • Published May '65 •
Shipping Weight 2-lb 9-oz • \$16.50

DESIGN AND APPLICATION OF TRANSISTOR SWITCHING CIRCUITS • LOUIS DELHOM

278 Pages • 315 Illustrations • Published January '68 •
Shipping Weight 2-lb • \$14.50

SOLID STATE COMMUNICATIONS

366 Pages • 417 Illustrations • Published April '66 •
Shipping Weight 2-lb 9-oz • \$12.50

SOLID STATE ELECTRONICS • ROBERT G. HIBBERD

170 Pages • 90 Illustrations • Published January '68 •
Shipping Weight 1-lb 12-oz • \$8.95

Terms: F.O.B. destination, bulk rate.
Other than bulk rate,
indicate method of shipment,
add shipping charges.

Outside U.S.: Indicate method of shipment,
add shipping charges.

Send check or money order
(no purchase orders) to:

EXECUTIVE SERVICES DISTRIBUTION
Suite 148
8383 Stemmons Freeway
Dallas, Texas 75247

TYPES 2N3993, 2N3994 P-CHANNEL DIFFUSED PLANAR SILICON FIELD-EFFECT TRANSISTORS



FOR HIGH-SPEED COMMUTATOR AND CHOPPER APPLICATIONS

- Low $r_{ds(on)}$: — 150 ohms max (2N3993)
- High y_{fs} / C_{iss} Ratio (High-Frequency Figure-of-Merit)
- Low Leakage • Low Capacitance

*mechanical data

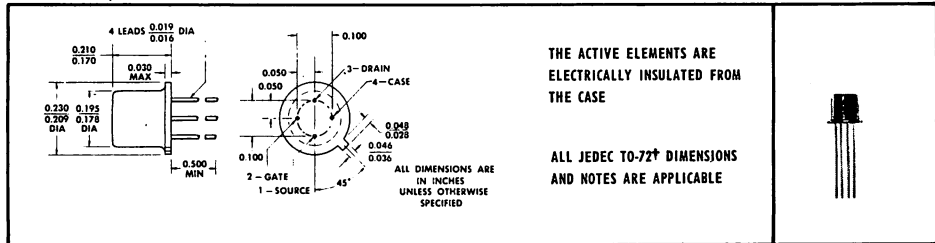

†TO-72 outline is same as TO-18 outline with the addition of a fourth lead.

*absolute maximum ratings at 25°C free-air temperature (unless otherwise noted)

Drain-Gate Voltage	—25 v
Drain-Source Voltage	—25 v
Reverse Gate-Source Voltage	25 v
Gate Current	—10 ma
Continuous Device Dissipation at (or below) 25°C Free-Air Temperature (See Note 1)	300 mw
Storage Temperature Range	—65°C to 200°C
Lead Temperature $\frac{1}{16}$ Inch from Case for 10 Seconds	300°C

*electrical characteristics at 25°C free-air temperature (unless otherwise noted)

PARAMETER	TEST CONDITIONS†	2N3993		2N3994		UNIT
		MIN	MAX	MIN	MAX	
$V_{(BR)GSS}$ Gate-Source Breakdown Voltage	$I_G = 1 \mu a, V_{DS} = 0$	25		25		v
I_{DGO} Drain Reverse Current	$V_{DG} = -15 v, I_S = 0$		—1.2		—1.2	na
	$V_{DG} = -15 v, I_S = 0, T_A = 150^\circ C$		—1.2		—1.2	μa
I_{DSS} Zero-Gate-Voltage Drain Current	$V_{DS} = -10 v, V_{GS} = 0, \text{ See Note 2}$	—10		—2		ma
	$V_{DS} = -10 v, V_{GS} = 6 v$				—1.2	na
$I_{D(off)}$ Drain Cutoff Current	$V_{DS} = -10 v, V_{GS} = 6 v, T_A = 150^\circ C$				—1	μa
	$V_{DS} = -10 v, V_{GS} = 10 v$		—1.2			na
	$V_{DS} = -10 v, V_{GS} = 10 v, T_A = 150^\circ C$		—1			μa
V_{GS} Gate-Source Voltage	$V_{DS} = -10 v, I_D = -1 \mu a$	4	9.5	1	5.5	v
$r_{ds(on)}$ Small-Signal Drain-Source "On" Resistance	$V_{GS} = 0, I_D = 0, f = 1 kc$		150		300	Ω
$ y_{fs} $ Small-Signal Common-Source Forward Transfer Admittance	$V_{DS} = -10 v, V_{GS} = 0, f = 1 kc, \text{ See Note 2}$	6	12	4	10	mmho
C_{iss} Common-Source Short-Circuit Input Capacitance	$V_{DS} = -10 v, V_{GS} = 0, f = 1 Mc$		16		16	pf
C_{rss} Common-Source Short-Circuit Reverse Transfer Capacitance	$V_{GS} = 6 v, V_{DS} = 0, f = 1 Mc$				5	pf
	$V_{GS} = 10 v, V_{DS} = 0, f = 1 Mc$		4.5			pf

NOTES: 1. Derate linearly to 175°C free-air temperature at the rate of 2 mw/°C

2. These parameters must be measured using pulse techniques. PW \approx 100 msec, Duty Cycle \leq 10%.

*Indicates JEDEC registered data.

†The fourth lead (case) is connected to the source for all measurements.



AUTHORIZED DISTRIBUTORS

FOR TEXAS INSTRUMENTS COMPONENTS GROUP

ALABAMA

ACK SEMICONDUCTORS INC.
3101 Fourth Ave. South/(205) FA 2-0588
Birmingham, Alabama 35233

ELECTRONIC WHOLESALERS, INC.
2310 Bob Wallace Avenue, S.W.
(205) 534-2461
Huntsville, Alabama 35805

ARIZONA

KIERULFF ELECTRONICS, INC.
2633 East Buckeye Road
(602) 273-7331
Phoenix, Arizona 85034

R. V. WEATHERFORD COMPANY
1917 North 25 Drive/(602) 272-7144
Carson Industrial Center
Phoenix, Arizona

CALIFORNIA

CALIFORNIA ELECTRONICS SUPPLY, INC.
1911 Armacost Avenue/(213) TR 9-0760
West Los Angeles, California 90025

KIERULFF ELECTRONICS, INC.
3969 E. Bayshore/(415) 968-6292
Palo Alto, California 94303

MILO OF CALIFORNIA
2060 India St./(714) BE 2-8951
San Diego, California 92101

RADIO PRODUCTS SALES, INC.
1501 S. Hill St./(213) RI 8-1271
Los Angeles, California 90015

R. V. WEATHERFORD COMPANY
1651 S. State College Blvd.
(714) KI 7-7521
Anaheim, California 92805

6921 San Fernando Rd./(213) VI 9-3451
Glendale, California 91201
3240 Hillview Drive
Stanford Industrial Park
(415) DA 1-5373
Palo Alto, California 94304

TI SUPPLY COMPANY
1651 Tenth Street/(213) 393-6731
Santa Monica, California 90404

COLORADO

TI SUPPLY COMPANY
2186 S. Holly/(303) 757-7671
Denver, Colorado 80222

FLORIDA

ELECTRONIC WHOLESALERS, INC.
345 Graham Ave./(305) 841-1550
Orlando, Florida 32814

9390 N. W. 27th Ave./(305) OX 6-1620
Miami, Florida 33147

ILLINOIS

ALLIED ELECTRONICS CORPORATION
100 N. Western Ave./(312) TA 9-9100
Chicago, Illinois 60680

MERQUIP ELECTRONICS, INC.
7701 No. Austin Ave./(312) 965-7500
Skokie, Illinois 60076

NEWARK ELECTRONICS CORP.
500 N. Pulaski Road/(312) 638-4411
Chicago, Illinois 60624

TI SUPPLY COMPANY
7135 N. Barry Avenue/(312) 296-7187
Des Plaines, Illinois 60018

INDIANA

ESCO ELECTRONICS INC.
2442 N. Shadeland Ave./(317) 357-8791
Indianapolis, Indiana 46219

RADIO DISTRIBUTING COMPANY
814 North Senate Avenue
(317) 637-5571
Indianapolis, Indiana 46204

IOWA

DEECO, INC.
618 First St., N. W./(319) EM 5-7551
Cedar Rapids, Iowa 52405

LOUISIANA

ELECTRONIC PRODUCTS CORPORATION
3622 Toulouse St./(504) HU 6-3777
New Orleans, Louisiana 70119

MARYLAND

ELECTRONIC WHOLESALERS, INC.
3200 Wilkens Ave./(301) 646-3600
Baltimore, Maryland 21223

MILGRAY/WASHINGTON
5405 Lafayette Place/(202) 864-1111
Hyattsville, Maryland 20781

MASSACHUSETTS

DEMAMBRO ELECTRONICS
1095 Commonwealth Ave.
(617) 787-1200
Boston, Massachusetts 02215

TI SUPPLY COMPANY
480 Neponset Road/(617) 828-5020
Canton, Massachusetts 02021

LAFAYETTE INDUSTRIAL ELECTRONICS
1400 Worcester Rd./(617) 969-6100
Natick, Massachusetts 01760

MILGRAY/NEW ENGLAND INC.
75 Terrace Hall Avenue/(617) 272-6800
Burlington, Massachusetts 02021

MICHIGAN

NEWARK-DETROIT ELECTRONICS, INC.
20700 Hubbell Ave./(313) 548-0250
Detroit, Michigan 48237

NEWARK-INDUSTRIAL
ELECTRONICS CORP.
2114 So. Division/(616) CH 1-5695
Grand Rapids, Michigan 49507

MINNESOTA

STARK ELECTRONIC SUPPLY CO.
112 Third Avenue N./(612) FE 2-1325
Minneapolis, Minnesota 55401

MISSOURI

TI SUPPLY COMPANY
2916 Holmes Street/(816) 753-4750
Kansas City, Missouri 64109

ELECTRONIC COMPONENTS FOR
INDUSTRY
2605 South Hanley Rd./(314) MI 7-5505
St. Louis, Missouri 63144

NEW JERSEY

GENERAL RADIO SUPPLY COMPANY, INC.
600 Penn St./(609) WO 4-8560
Camden, New Jersey 08102

TI SUPPLY COMPANY
301 Central Ave./(201) 382-6400
Clark, N. J. 07066

NEW MEXICO

KIERULFF ELECTRONICS, INC.
2524 Baylor Dr. S.E./(505) 247-1055
Albuquerque, New Mexico 87108

NEW YORK

GENESEE RADIO & PARTS CO., INC.
2550 Delaware Ave./(716) TR 3-9661
Buffalo, New York 14216

LAFAYETTE INDUSTRIAL ELECTRONICS
165-08 Liberty Ave./(212) 658-5050
Jamaica, New York 11431

MILGRAY/NEW YORK
160 Varick St./(212) YU 9-1600
New York, New York 10013

ROCHESTER RADIO SUPPLY CO., INC.
140 W. Main St./(716) 454-7800
Rochester, New York 14614

TI SUPPLY COMPANY
4 Nevada Dr./(516) 488-3300
New Hyde Park, L. I., N. Y. 11040

NORTH CAROLINA
ELECTRONIC WHOLESALERS, INC.
938 Burke St./(919) PA 5-8711
Winston-Salem, North Carolina 27101

OHIO

ESCO ELECTRONICS INC.
3130 Valleywood Drive/(513) 298-0191
Dayton, Ohio 45429

MILGRAY/CLEVELAND
1821 East 40th Street/(216) 881-8800
Cleveland, Ohio 44102

NEWARK-HERRLINGER
ELECTRONICS CORP.
112 E. Liberty St./(513) GA 1-5282
Cincinnati, Ohio 45210

W. M. PATTISON SUPPLY CO.
4550 Willow Parkway/(216) 441-3000
Cleveland, Ohio 44125

SREPCO ELECTRONICS, INC.
314 Leo Street/(513) BA 4-3871
Dayton, Ohio 45404

OKLAHOMA

TI SUPPLY COMPANY
12151 E. Skelly Dr./(918) 437-4555
Tulsa, Oklahoma 74110

OREGON

ALMAC STROUM ELECTRONICS
CORPORATION
8888 S.W. Canyon Road/(503) 292-3534
Portland, Oregon 97225

PENNSYLVANIA

MILGRAY/DELAWARE VALLEY INC.
2532 N. Broad St./(215) BA 8-2000
Philadelphia, Penn. 19107

RPC ELECTRONICS
620 Alpha Dr./(412) 782-3770
RIDC Park
Pittsburgh, Pennsylvania 15238

TEXAS

TI SUPPLY COMPANY
6000 Denton Drive/(214) FL 7-6121
Dallas, Texas 75235

5240 Elm Street/(713) MO 6-2175
Houston, Texas 77036

HARRISON EQUIPMENT COMPANY, INC.
1422 San Jacinto St./(713) CA 4-9131
Houston, Texas 77001

MIDLAND SPECIALTY COMPANY
2235 Wyoming Ave./(915) KE 3-9555
El Paso, Texas 79903

UTAH

STANDARD SUPPLY COMPANY
225 E. Sixth South St./(801) EL 5-2971
Salt Lake City, Utah 84110

WASHINGTON

ALMAC-STROUM ELECTRONICS
5811 Sixth Ave. So./(206) 763-2300
Seattle, Washington 98108

WASHINGTON, D.C.

ELECTRONIC WHOLESALERS, INC.
2345 Sherman Ave., N. W.
(202) HU 3-5200
Washington, D.C. 20001

CANADA

CANADIAN ELECTRONICS LTD.
Calgary, Alberta
Edmonton, Alberta
Lethbridge, Alberta
Medicine Hat, Alberta
Vancouver, B. C.

CESCO ELECTRONICS LTD.
Downsview, Quebec
Quebec, Quebec
Ottawa, Ontario
Toronto, Ontario

TI SUPPLY COMPANY
Dorval, Quebec

WELLINGTON, New Zealand

W. G. LEATHAM LTD.

AUSTRALIAN TI DISTRIBUTOR

MELBOURNE, Australia
RADIO PARTS PTY, LTD.

PERTH, Australia
PRECISION ELECTRONICS

BRISBANE, Australia
DOUGLAS ELECTRONICS

EUROPEAN TI DISTRIBUTORS

BRUSSELS IV, Belgium
S.A. AVI-ELEC N.V.

COPENHAGEN V, Denmark
TEXAS INSTRUMENTS A/S

HELSINKI, Finland
OY CHESTER AB

HAMBURG, West Germany
FIRMA ALFRED NEYE, ENATECHNIK

STUTTGART, WEST GERMANY
TI SUPPLY CO.

OSLO, Norway
MORGENSTIERNE & CO.

STOCKHOLM, Sweden
AB GOSTA BACKSTROM

ZURICH 32, Switzerland
FABRIMEX AG ZURICH

PARIS, FRANCE
TI SUPPLY CO.

MILANO, ITALY
TI SUPPLY CO.

MANCHESTER, ENGLAND
TI SUPPLY CO.

TYPES 2N4416, 2N4416A N-CHANNEL EPITAXIAL PLANAR SILICON FIELD-EFFECT TRANSISTORS



FOR VHF AMPLIFIER AND MIXER APPLICATIONS

- High Power Gain... 10 dB Min at 400 MHz
- Low Noise Figure... 4 dB Max at 400 MHz
- High Transconductance... 4000 μ mho Min at 400 MHz
- Low C_{rss} ... 0.8 pF Max
- High $|y_{fs}|/C_{iss}$ Ratio (High-Frequency Figure-of-Merit)
- Cross-Modulation Minimized by Square-Law Transfer Characteristic
- Recommended for Use in VHF-UHF Bandpass Amplifiers
- Excellent for General-Purpose Amplifier and Chopper Applications

TYPES 2N4416, 2N4416A
BULLETIN NO. DL-5-6810649, JANUARY 1968
REPLACES BULLETIN NO. DL-5-6710392, NOVEMBER, 1967

*mechanical data

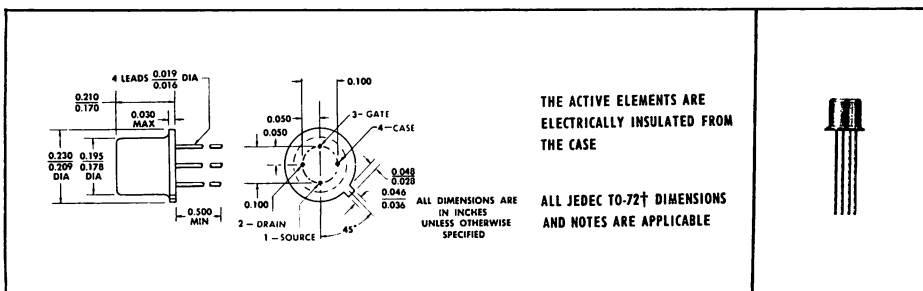

†TO-72 outline is same as TO-18 outline with the addition of a fourth lead.

absolute maximum ratings at 25°C free-air temperature (unless otherwise noted)

	2N4416	2N4416A
*Drain-Gate Voltage	30 V	35 V
*Drain-Source Voltage	30 V	35 V
*Reverse Gate-Source Voltage	-30 V	-35 V
*Continuous Forward Gate Current	← 10 mA →	
*Continuous Device Dissipation at (or below) 25°C Free-Air Temperature (See Note 1)	← 300 mW →	
Continuous Device Dissipation at (or below) 125°C Case Temperature (See Note 2)	← 450 mW →	
*Storage Temperature Range	-65°C to 200°C	
*Lead Temperature 1/16 Inch from Case for 60 Seconds	← 300°C →	

NOTES: 1. Derate linearly to 200°C free-air temperature at the rate of 1.7 mW/deg.
2. Derate linearly to 200°C case temperature at the rate of 6 mW/deg.

*Indicates JEDEC registered data



TEXAS INSTRUMENTS
INCORPORATED
POST OFFICE BOX 5012 • DALLAS, TEXAS 75222

TYPES 2N4416, 2N4416A

N-CHANNEL EPITAXIAL PLANAR SILICON FIELD-EFFECT TRANSISTORS

electrical characteristics at 25°C free-air temperature (unless otherwise noted)

PARAMETER	TEST CONDITIONS	2N4416		2N4416A		UNIT
		MIN	MAX	MIN	MAX	
$V_{(BR)ESS}$ Gate-Source Breakdown Voltage	$I_G = -1 \mu A, V_{DS} = 0$	-30*		-35*		V
$V_{ES(f)}$ Gate-Source Forward Voltage	$I_G = 1 mA, V_{DS} = 0$	1*		1*		V
I_{GSS} Gate Reverse Current	$V_{GS} = -20 V, V_{DS} = 0$	-0.1*		-0.1*		nA
	$V_{GS} = -20 V, V_{DS} = 0, T_A = 150^\circ C$	-0.2*		-0.2*		μA
		-0.1†		-0.1†		
$V_{GS(off)}$ Gate-Source Cutoff Voltage	$V_{DS} = 15 V, I_D = 1 nA$	-6*		-2.5*	-6*	V
V_{GS} Gate-Source Voltage	$V_{DS} = 15 V, I_D = 0.5 mA$	-1*	-5.5*	-1*	-5.5*	V
I_{DSS} Zero-Gate-Voltage Drain Current	$V_{DS} = 15 V, V_{GS} = 0$, See Note 3	5*	15*	5*	15*	mA
$ y_{fs} $ Small-Signal Common-Source Forward Transfer Admittance	$V_{DS} = 15 V,$ $V_{GS} = 0,$ $f = 1 kHz$	4.5*	7.5*	4.5*	7.5*	mmho
$ y_{os} $ Small-Signal Common-Source Output Admittance		0.05*	0.05*			
C_{iss} Common-Source Short-Circuit Input Capacitance	$V_{DS} = 15 V,$ $V_{GS} = 0,$ $f = 1 MHz$	4*		4*		pF
C_{rss} Common-Source Short-Circuit Reverse Transfer Capacitance		0.8*		0.8*		
C_{oss} Common-Source Short-Circuit Output Capacitance		2*		2*		
$Re(y_{is})$ Small-Signal Common-Source Input Conductance	$V_{DS} = 15 V,$ $V_{GS} = 0,$ $f = 100 MHz$	0.1*		0.1*		mmho
$Im(y_{is})$ Small-Signal Common-Source Input Susceptance		2.5*		2.5*		
$Re(y_{os})$ Small-Signal Common-Source Output Conductance		0.075*		0.075*		
$Im(y_{os})$ Small-Signal Common-Source Output Susceptance		1*		1*		
$Re(y_{is})$ Small-Signal Common-Source Input Conductance	$V_{DS} = 15 V,$ $V_{GS} = 0,$ $f = 400 MHz$	1*		1*		mmho
$Im(y_{is})$ Small-Signal Common-Source Input Susceptance		10*		10*		
$Re(y_{fs})$ Small-Signal Common-Source Forward Transfer Conductance		4*		4*		
$Re(y_{os})$ Small-Signal Common-Source Output Conductance		0.1*		0.1*		
$Im(y_{os})$ Small-Signal Common-Source Output Susceptance		4*		4*		

NOTE 3: This parameter must be measured using pulse techniques. $I_D = 300 \mu A$, duty cycle $\leq 1\%$.

†Texas Instruments guarantees this value in addition to the JEDEC registered value, which is also shown.

*operating characteristics at 25°C free-air temperature

PARAMETER	TEST CONDITIONS	MIN	MAX	UNIT
G_{ps} Small-Signal Common-Source Neutralized Insertion Power Gain	$V_{DS} = 15 V, I_D = 5 mA, f = 100 MHz,$ $R_G' = 1 k\Omega,$ See Figure 1	18		dB
	$V_{DS} = 15 V, I_D = 5 mA, f = 400 MHz,$ $R_G' = 1 k\Omega,$ See Figure 1	10		
NF Spot Noise Figure	$V_{DS} = 15 V, I_D = 5 mA, f = 100 MHz,$ $R_G' = 1 k\Omega,$ See Figure 1		2	dB
	$V_{DS} = 15 V, I_D = 5 mA, f = 400 MHz,$ $R_G' = 1 k\Omega,$ See Figure 1		4	

*Indicates JEDEC registered data

TYPES 2N4416, 2N4416A N-CHANNEL EPITAXIAL PLANAR SILICON FIELD-EFFECT TRANSISTORS

PARAMETER MEASUREMENT INFORMATION

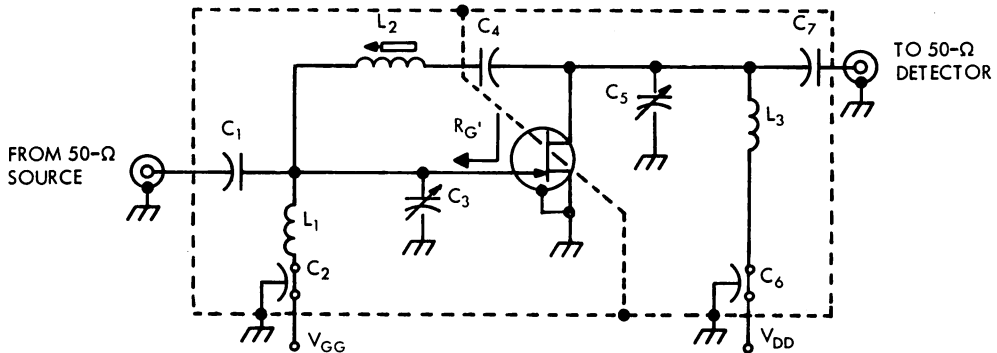

CIRCUIT COMPONENT INFORMATION (See Note 4)

CAPACITORS		COILS	
	100 MHz	100 MHz	400 MHz
C_1	7 pF	L_1	0.14 μ H, 3.5 T, #18 enameled copper wire, $\frac{3}{8}$ " I.D., $\frac{1}{4}$ " long
C_2	0.0015 μ F		0.022 μ H, $\frac{3}{8}$ " of #16 copper wire formed to 0.5 T, $\frac{1}{4}$ " I.D.
C_3	1-12 pF	L_2	3 μ H, 17 T, #28 enameled copper wire, close wound, $\frac{3}{32}$ " I.D., powdered iron slug
C_4	1000 pF		0.2 μ H, 6 T, #24 enameled copper wire, close wound, $\frac{3}{32}$ " I.D., aluminum slug
C_5	1-12 pF	L_3	0.25 μ H, 4.5 T, #18 enameled copper wire, $\frac{3}{8}$ " I.D., $\frac{3}{16}$ " long
C_6	0.0015 μ F		0.03 μ H, $1\frac{1}{2}$ " of #16 enameled copper wire formed to 1 T, $\frac{3}{8}$ " I.D.
C_7	3 pF		

FIGURE 1 — NEUTRALIZED POWER GAIN AND SPOT-NOISE FIGURE TEST CIRCUIT

NOTE 4: Transformed equivalent source resistance ($R'g$) is 1000 Ω at 100 MHz for 100-MHz amplifier, and 1000 Ω at 400 MHz for 400-MHz amplifier.

TYPICAL CHARACTERISTICS

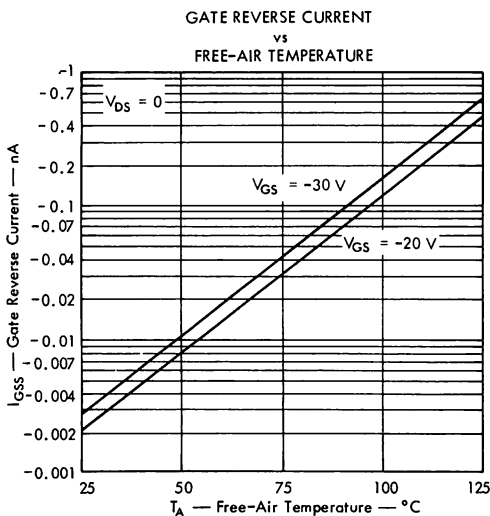

FIGURE 2

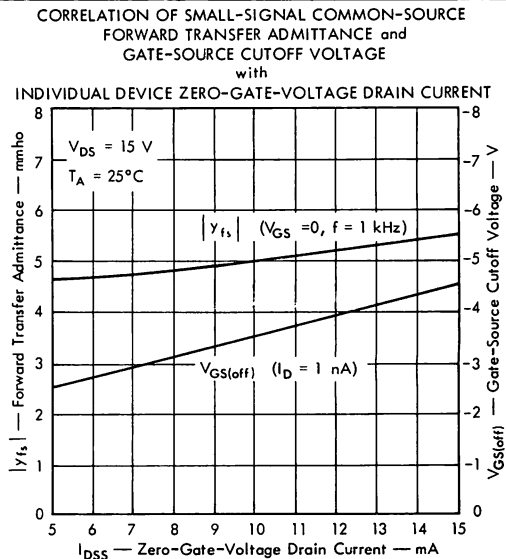

FIGURE 3

TYPES 2N4416, 2N4416A

N-CHANNEL EPITAXIAL PLANAR SILICON FIELD-EFFECT TRANSISTORS

TYPICAL CHARACTERISTICS

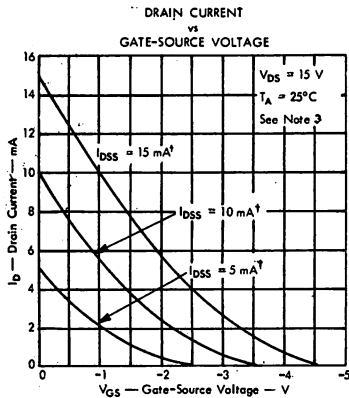

FIGURE 4

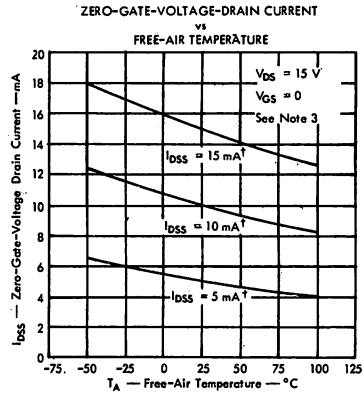

FIGURE 5

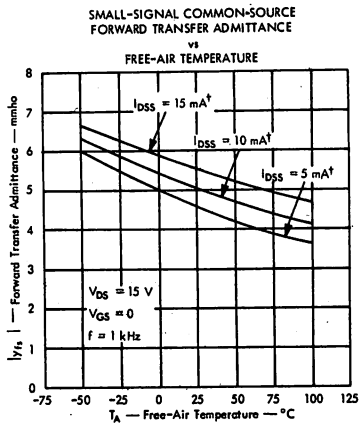

FIGURE 6

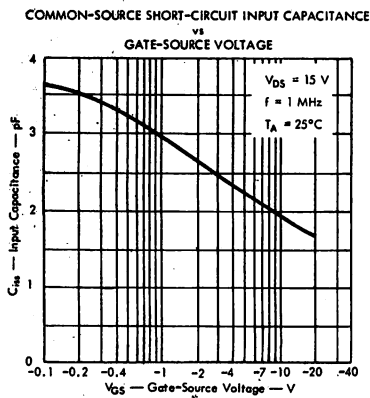

FIGURE 7

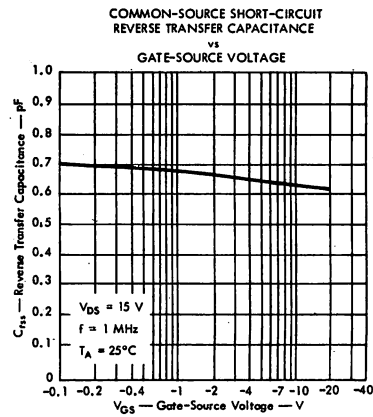

FIGURE 8

NOTE 3: This parameter must be measured using pulse techniques. $t_p = 300 \mu\text{s}$, duty cycle $\leq 2\%$.

†Data is for devices having the indicated values of I_{DSS} at $V_{DS} = 15 \text{ V}$, $V_{GS} = 0$, and $T_A = 25^\circ\text{C}$.

TYPES 2N4416, 2N4416A N-CANNEL EPITAXIAL PLANAR SILICON FIELD-EFFECT TRANSISTORS

TYPICAL CHARACTERISTICS

SMALL-SIGNAL COMMON-SOURCE INPUT ADMITTANCE
vs
NORMALIZED DRAIN CURRENT

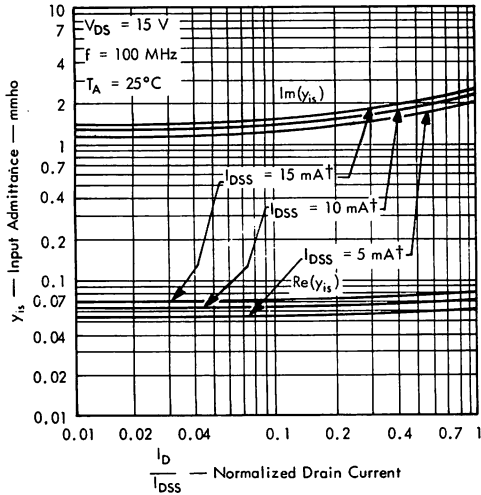

FIGURE 9

SMALL-SIGNAL COMMON-SOURCE
FORWARD TRANSFER ADMITTANCE
vs
NORMALIZED DRAIN CURRENT

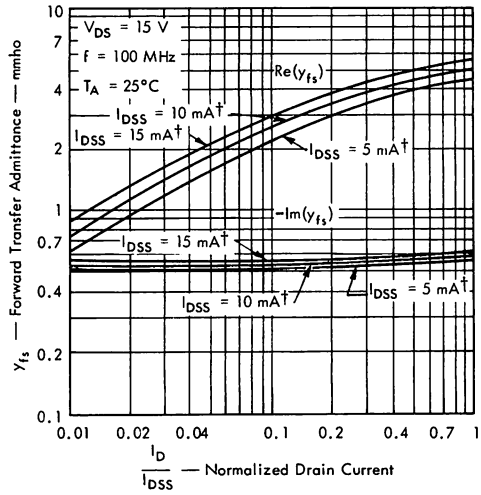

FIGURE 10

SMALL-SIGNAL COMMON-SOURCE
REVERSE TRANSFER ADMITTANCE
vs
NORMALIZED DRAIN CURRENT

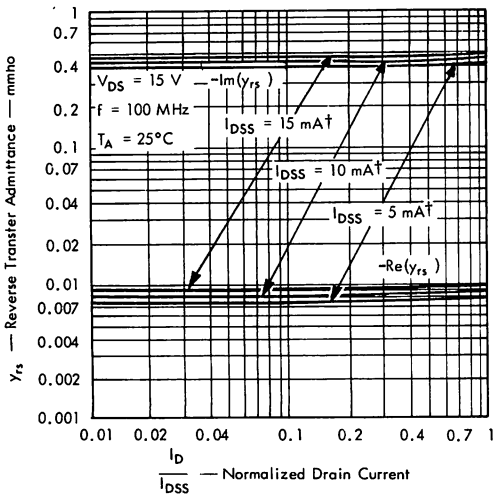

FIGURE 11

SMALL-SIGNAL COMMON-SOURCE OUTPUT ADMITTANCE
vs
NORMALIZED DRAIN CURRENT

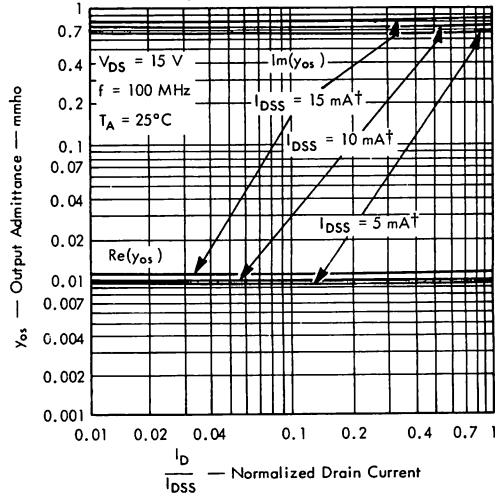

FIGURE 12

†Data is for devices having the indicated values of I_{DSS} at $V_{DS} = 15$ V, $V_{GS} = 0$, and $T_A = 25^\circ\text{C}$.

TYPES 2N4416, 2N4416A

N-CHANNEL EPITAXIAL PLANAR SILICON FIELD-EFFECT TRANSISTORS

TYPICAL CHARACTERISTICS

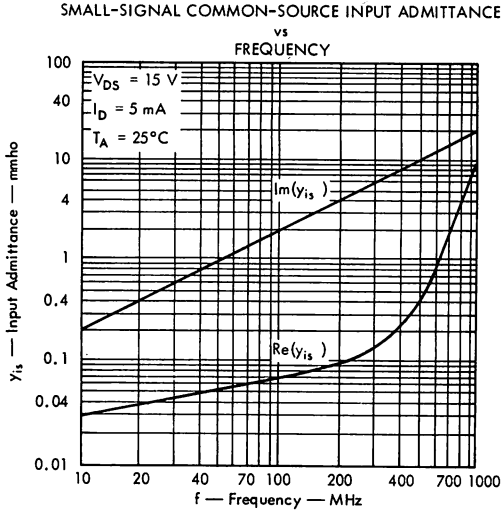

FIGURE 13

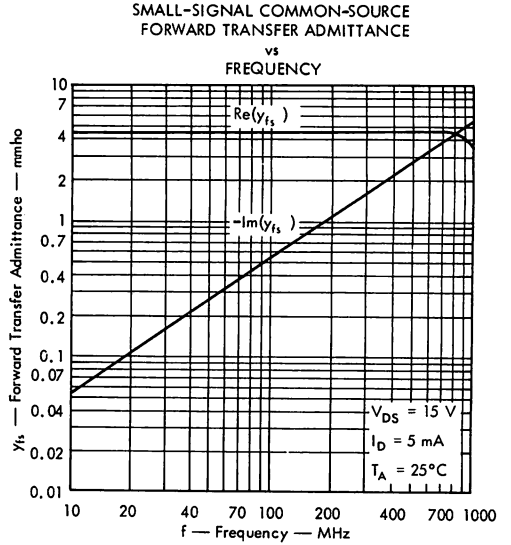

FIGURE 14

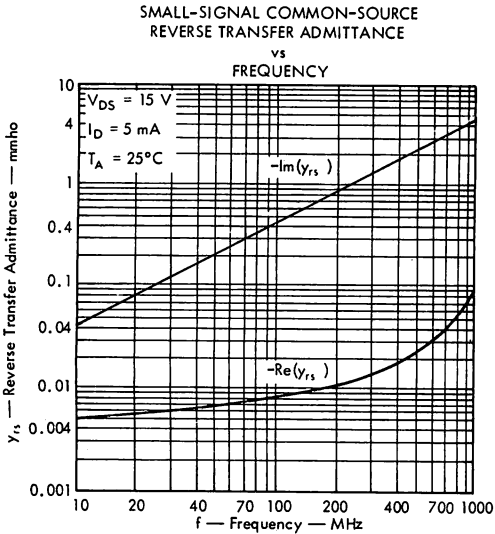

FIGURE 15

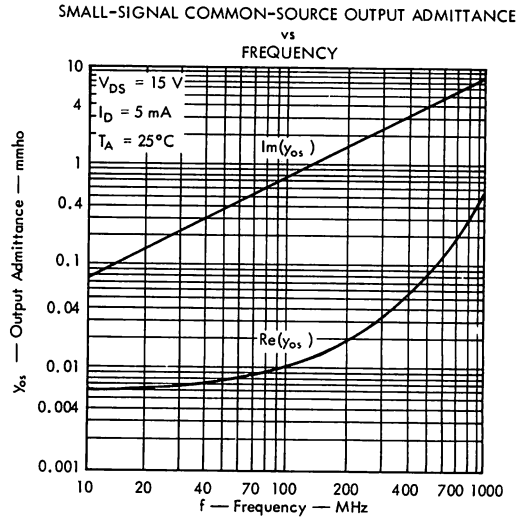

FIGURE 16

TYPES 2N4416, 2N4416A N-CHANNEL EPITAXIAL PLANAR SILICON FIELD-EFFECT TRANSISTORS

TYPICAL CHARACTERISTICS

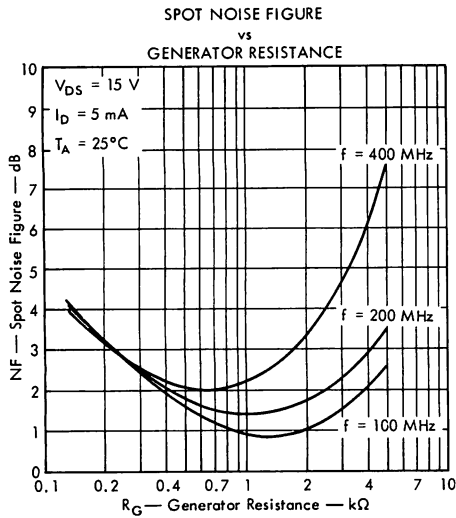

FIGURE 17

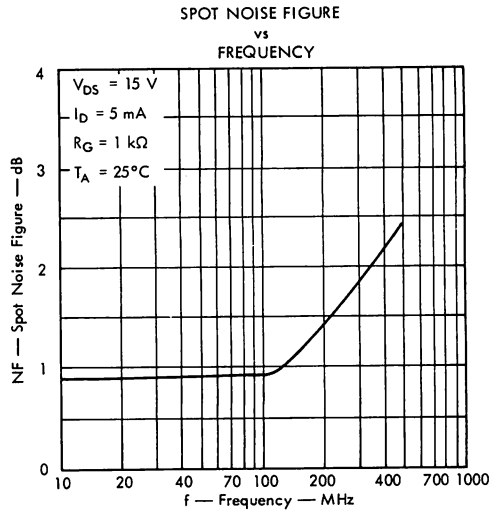

FIGURE 18

THERMAL INFORMATION

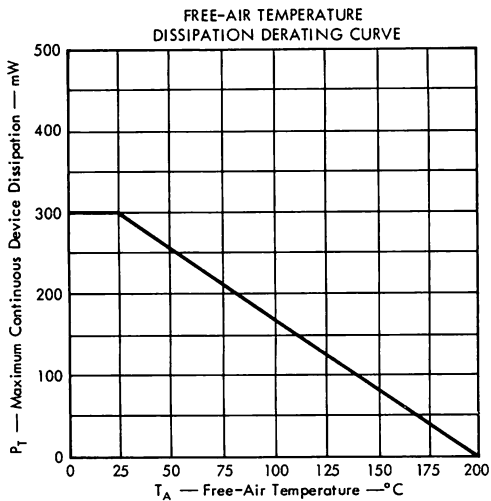

FIGURE 19

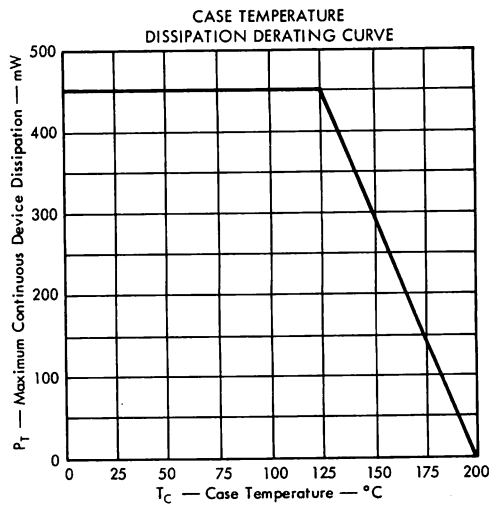

FIGURE 20

TI World-Wide Sales Offices

ALABAMA

Sahara Office Park Bldg., Suite 111
3313 Memorial Parkway, S.W.
Huntsville, Alabama 35801
205-881-4061

ARIZONA

2535 W. Camelback Rd., Suite 1D
Phoenix, Arizona 85017
602-279-5531

CALIFORNIA

1800 North Argyle Ave.
Hollywood, California 90028
213-466-7251

5005 West Century Blvd., Suite 208
Inglewood, California 90301
213-673-3943

230 California Ave., Suite 201
Palo Alto, California 94306
415-326-6770

1505 East 17th St., Suite 201
Santa Ana, California 92701
714-547-6506

4185 Adams Ave.
San Diego, California 92116
714-284-1181

COLORADO

2186 South Holly St., Suite 204
Denver, Colorado 80222
303-757-8548

CONNECTICUT

300 Amity Road
Woodbridge, Connecticut 06525
203-389-4521

FLORIDA

618 East South St., Suite 114
Orlando, Florida 32801
305-422-9894

ILLINOIS

Suite 205, Executive Towers
5901 N. Cicero Ave.
Chicago, Illinois 60646
312-286-1000

MASSACHUSETTS

60 Hickory Drive
Waltham, Mass. 02154
617-891-8450

MICHIGAN

Suite 706 West, Northland Towers Bldg.
15565 Northland Dr.
Southfield, Michigan 48075
313-357-1703

MINNESOTA

7615 Metro Blvd.
Suite 202, U.C.L.I. Bldg.
Edina, Minn. 55424
612-941-4384

NEW JERSEY

U.S. Highway #22
P.O. Box 366
Union, New Jersey 07083
201-687-7200

NEW YORK

P. O. Box 87, 2209 E. Main
Endicott, New York 13760
607-785-9987

4 Nevada Drive
New Hyde Park, N. Y. 11040
516-488-9894

131 Fulton Ave., Apt. J-2
Poughkeepsie, New York 12603
914-471-6095

6563 Ridings Rd.
Syracuse, New York 13206
315-463-9291

OHIO

22035 Chagrin Blvd.
Cleveland, Ohio 44122
216-751-2600

Suite 205, Paul Welch Bldg.
3300 South Dixie Dr.
Dayton, Ohio 45439
513-298-7513

PENNSYLVANIA

Benjamin Fox Pavilion
Suite 424, Foxcroft Square
Jenkintown, Pa. 19046
215-885-3454

TEXAS

MS80 — P.O. Box 5012
Dallas, Texas 75222
214-238-4861

3609 Buffalo Speedway
Houston, Texas 77006
713-526-3268

WASHINGTON

5801 Sixth Ave. S.
Seattle, Washington 98108
206-762-4240

WASHINGTON, D.C.

1875 Connecticut Ave., N.W., Suite 913
Washington, D.C. 20009
202-234-9320

CANADA

Geophysical Service Incorporated
280 Centre Str. East
Richmond Hills
Ontario, Canada
925-1035

663 Orly Avenue
Dorval
Quebec, Canada
631-6010

EUROPE

Texas Instruments Limited
Manton Lane
Bedford, England

Texas Instruments France S. A.
Boite Postale 5
Villeneuve-Loubet (A.M.), France

11 rue de Madrid
Paris 8°, France

Texas Instruments Holland N.V.
Semiconductor Division
Enschedeestraat 19
Hengelo (Ov), Holland

Texas Instruments Italia S.p.A.
Via Colautti 1
Milan, Italy

Texas Instruments Incorporated
118 Rue du Rhone
1204 Geneva, Switzerland

Texas Instruments Sweden A.B.
Timmermangatan 34, Box 17116
Stockholm 17, Sweden

Texas Instruments Deutschland GmbH
Hildesheimerstr. 19
3 Hannover, W. Germany

Texas Instruments Deutschland GmbH
Wolframstrasse 26
7 Stuttgart
West Germany

Texas Instruments Deutschland GmbH
Clemensstrasse 30
8 Munich 23
West Germany

Texas Instruments Deutschland GmbH
Kepserstrasse 33
805 Freising-Lerchenfeld
West Germany

Texas Instruments Deutschland GmbH
Koenigsbacherstrasse 22
6 Frankfurt, West Germany

MEXICO

Texas Instruments de Mexico S.A.
Poniente 116 #489
Col. Ind. Vallejo
Mexico 15, D.F.

ARGENTINA

Texas Instruments Argentina S.A.I.C.F.
(P. O. Box 2296 — Correo Central)
Ruta Panamericana Km. 13, 5
Don Torcuato
Buenos Aires, Argentina

BRAZIL

Texas Instrumentos Electronicos
do Brazil Ltda.
Rua Cesario Alvim 770
Caixa Postal 30.103
Sao Paulo 6, Brazil

AUSTRALIA

Texas Instruments Australia Ltd.
Box 63, Oldham Road
Elizabeth, South Australia

Texas Instruments Australia Ltd
Room 5, Rural Bank Bldg.
Burwood, N.S.W., Australia

JAPAN

Texas Instruments Asia Limited
404 T.B.R. Building
No. 59, 2-chome, Nagata-cho
Chiyoda-du, Tokyo, Japan

TYPES 2N4856, 2N4857, 2N4858, 2N4859, 2N4860, 2N4861 N-CHANNEL EPITAXIAL PLANAR SILICON FIELD-EFFECT TRANSISTORS



TYPES 2N4856 THRU 2N4861
BULLETIN NO. DL-S 669371, NOVEMBER 1966

SYMMETRICAL N-CHANNEL FIELD-EFFECT TRANSISTORS FOR HIGH-SPEED COMMUTATOR AND CHOPPER APPLICATIONS 2N4859 Formerly TIXS41

- Low $r_{ds(on)}$: 25 Ω Max (2N4856, 2N4859)
- Low $I_{D(off)}$: 0.25 nA Max

*mechanical data

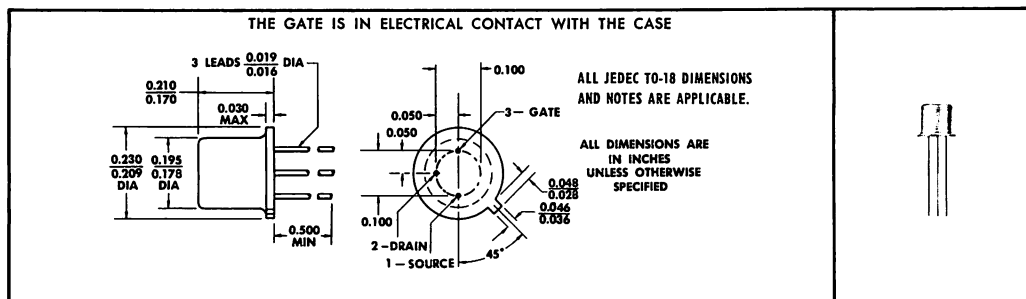

*absolute maximum ratings at 25°C free-air temperature (unless otherwise noted)

	2N4856 2N4857 2N4858	2N4859 2N4860 2N4861
Drain-Gate Voltage	40 V	30 V
Drain-Source Voltage	40 V	30 V
Reverse Gate-Source Voltage	-40 V	-30 V
Forward Gate Current	← 50 mA →	
Continuous Device Dissipation at (or below) 25°C Free-Air Temperature (See Note 1)	← 360 mW →	
Storage Temperature Range	-65°C to 200°C	
Lead Temperature 1/8 Inch from Case for 10 Seconds	← 300°C →	

NOTE 1: Derate linearly to 175°C free-air temperature at the rate of 2.4 mW/deg.
*Indicates JEDEC registered data

TYPES 2N4856 THRU 2N4861

N-CHANNEL EPITAXIAL PLANAR SILICON FIELD-EFFECT TRANSISTORS

*electrical characteristics at 25°C free-air temperature (unless otherwise noted)

PARAMETER	TEST CONDITIONS	2N4856		2N4857		2N4858		2N4859		2N4860		2N4861		UNIT
		MIN	MAX	MIN	MAX	MIN	MAX	MIN	MAX	MIN	MAX	MIN	MAX	
V_{BRIGSS} Gate-Source Breakdown Voltage	$I_G = -1 \mu A, V_{DS} = 0$	-40		-40		-40		-30		-30		-30		V
I_{GSS} Gate Reverse Current	$V_{GS} = -20 V, V_{DS} = 0$	-0.25		-0.25		-0.25								nA
	$V_{GS} = -20 V, V_{DS} = 0, T_A = 150^\circ C$	-0.5		-0.5		-0.5								μA
	$V_{GS} = -15 V, V_{DS} = 0$							-0.25		-0.25		-0.25		nA
	$V_{GS} = -15 V, V_{DS} = 0, T_A = 150^\circ C$							-0.5		-0.5		-0.5		μA
$I_{D(off)}$ Drain Cutoff Current	$V_{DS} = 15 V, V_{GS} = -10 V$	0.25		0.25		0.25		0.25		0.25		0.25		nA
	$V_{DS} = 15 V, V_{GS} = -10 V, T_A = 150^\circ C$	0.5		0.5		0.5		0.5		0.5		0.5		μA
$V_{GS(off)}$ Gate-Source Cutoff Voltage	$V_{DS} = 15 V, I_D = 0.5 nA$	-4	-10	-2	-6	-0.8	-4	-4	-10	-2	-6	-0.8	-4	V
I_{DSS} Zero-Gate-Voltage Drain Current	$V_{DS} = 15 V, V_{GS} = 0$, See Note 2	50		20	100	8	80	50		20	100	8	80	mA
$V_{DS(on)}$ Drain-Source On-State Voltage	$I_D = 20 mA, V_{GS} = 0$	0.75						0.75						V
	$I_D = 10 mA, V_{GS} = 0$			0.50						0.50				V
	$I_D = 5 mA, V_{GS} = 0$					0.50						0.50		V
$r_{ds(on)}$ Small-Signal Drain-Source On-State Resistance	$V_{GS} = 0, I_D = 0, f = 1 kHz$	25		40		60		25		40		60		Ω
C_{iss} Common-Source Short-Circuit Input Capacitance	$V_{GS} = -10 V, V_{DS} = 0, f = 1 MHz$	18		18		18		18		18		18		pF
C_{rss} Common-Source Short-Circuit Reverse Transfer Capacitance	$V_{GS} = -10 V, V_{DS} = 0, f = 1 MHz$	8		8		8		8		8		8		pF

*switching characteristics at 25°C free-air temperature

PARAMETER	TEST CONDITIONS	2N4856	2N4857	2N4858	UNIT
		2N4859	2N4860	2N4861	
$t_{d(on)}$ Turn-On Delay Time	$V_{DD} = 10 V, I_{D(on)} \dagger = \begin{cases} 20 mA (2N4856, 2N4859) \\ 10 mA (2N4857, 2N4860) \\ 5 mA (2N4858, 2N4861) \end{cases}$	6	6	10	ns
t_r Rise Time		3	4	10	ns
t_{off} Turn-Off Time		See Figure 1 $V_{GS(off)} = \begin{cases} -10 V (2N4856, 2N4859) \\ -6 V (2N4857, 2N4860) \\ -4 V (2N4858, 2N4861) \end{cases}$	25	50	100

NOTE 2: This parameter must be measured using pulse techniques. $t_p \approx 100 ms$, duty cycle $\leq 10\%$.

*Indicates JEDEC registered data

†These are nominal values; exact values vary slightly with transistor parameters.

TYPES 2N4856 THRU 2N4861 N-CHANNEL EPITAXIAL PLANAR SILICON FIELD-EFFECT TRANSISTORS

*PARAMETER MEASUREMENT INFORMATION

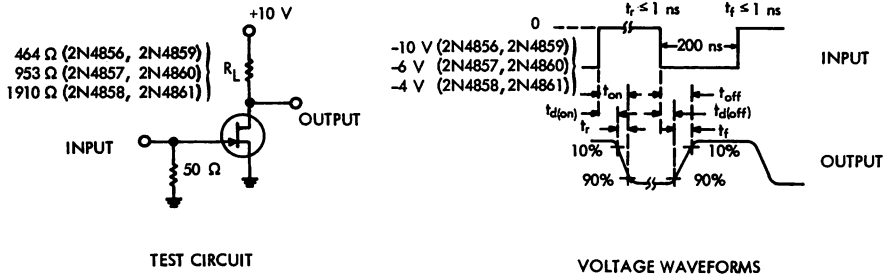

FIGURE 1

NOTES: a. The input waveforms are supplied by a generator with the following characteristics: $Z_{out} = 50 \Omega$, duty cycle $\approx 2\%$.
b. Waveforms are monitored on an oscilloscope with the following characteristics: $t_r \leq 0.75$ ns, $R_{in} \geq 1$ M Ω , $C_{in} \leq 2.5$ pF.

*Indicates JEDEC registered data

TYPICAL CHARACTERISTICS

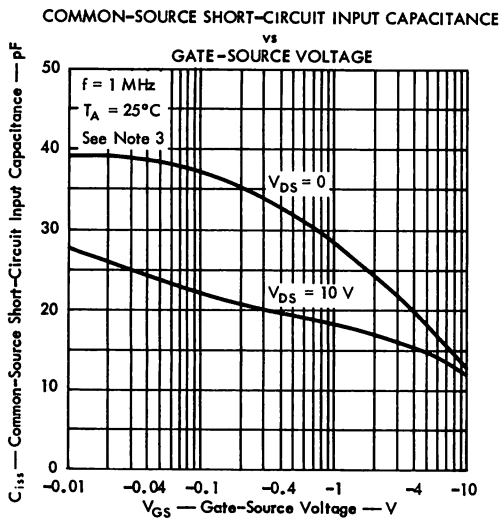

FIGURE 2

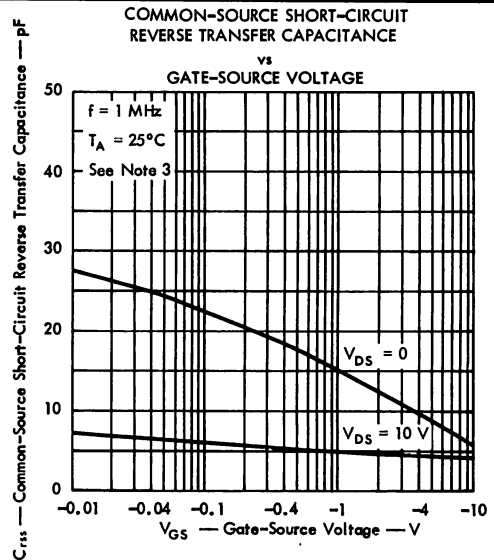
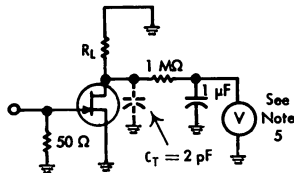
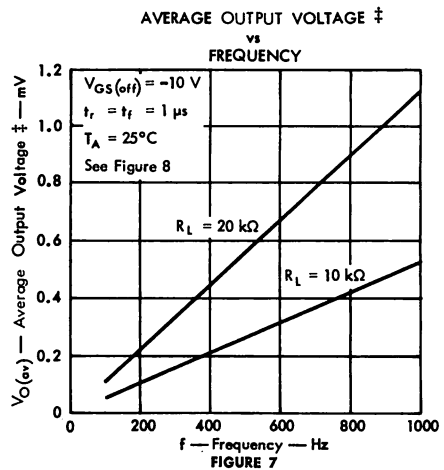
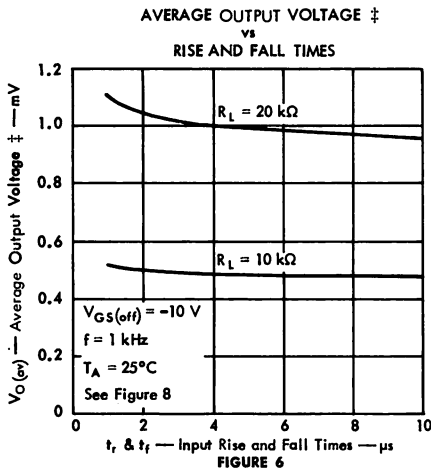
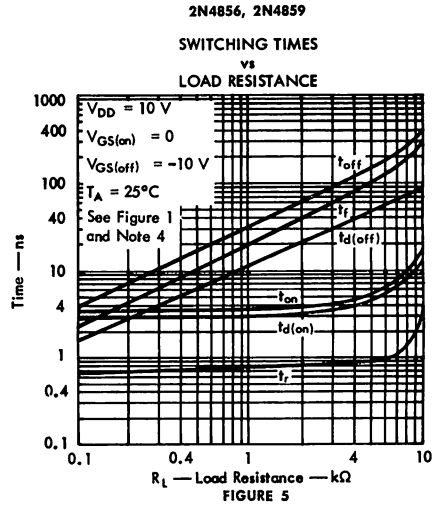
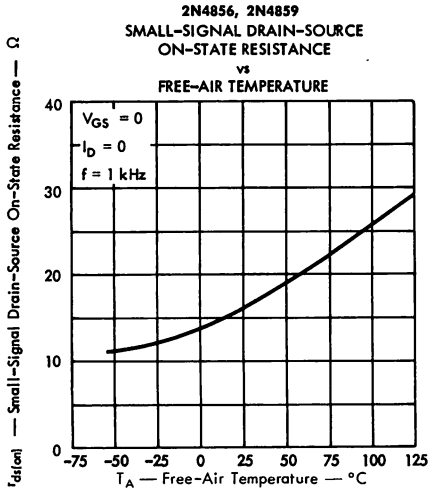

FIGURE 3

NOTE 3: These parameters were measured with bias voltages applied for less than five seconds to avoid overheating the devices.

TYPES 2N4856 THRU 2N4861 N-CHANNEL EPITAXIAL PLANAR SILICON FIELD-EFFECT TRANSISTORS

TYPICAL CHARACTERISTICS



TEST CIRCUIT

FIGURE 8. MEASUREMENT INFORMATION FOR FIGURES 6 & 7

- NOTES: 4. The circuit of figure 1 is used, varying R_L from 100 Ω to 10 $k\Omega$. $t_p = 1 \mu s$, duty cycle $\leq 2\%$.
5. Voltmeter input resistance $R_{in} \geq 10 M\Omega$.

\ddagger In the circuit of figure 8, Average Output Voltage results from capacitive feed-through of the gate-drive signal.

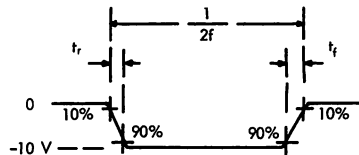

INPUT VOLTAGE WAVEFORM

TYPES 2N5045, 2N5046, 2N5047 DUAL N-CANNEL EPITAXIAL PLANAR SILICON FIELD-EFFECT TRANSISTORS



TYPES 2N5045, 2N5046, 2N5047
BULLETIN NO. DL-5-679714, MARCH 1967

MATCHED, SYMMETRICAL, FIELD-EFFECT TRANSISTORS

- High $|y_{fs}|/C_{iss}$ Ratio (High-Frequency Figure-of-Merit)
- Low Input Capacitance $C_{iss} \dots 8 \text{ pF Max}$
- Low Gate Reverse Current Differential $\dots 10 \text{ nA Max at } T_A = 100^\circ\text{C}$
- Recommended for Low-Level D-C Amplifiers, Sample-Hold Circuits, and Series-Shunt Choppers

*mechanical data

6 LEADS 0.019 DIA
0.016

0.210
0.170

0.020
MAX.

0.230 0.195
0.209 0.175
DIA DIA

0.500
MIN.

0.050 T.P.
0.050 T.P.

0.100 T.P.

0.100 T.P.

0.040
0.028
0.040
0.026

45° T.P.

45° T.P.

ALL DIMENSIONS ARE
IN INCHES
UNLESS OTHERWISE
SPECIFIED

1. SOURCE 1
2. DRAIN 1
3. GATE 1
5. SOURCE 2
6. DRAIN 2
7. GATE 2

THE ACTIVE ELEMENTS ARE
ELECTRICALLY INSULATED FROM
THE CASE

ALL JEDEC TO-71 DIMENSIONS
AND NOTES ARE APPLICABLE

*absolute maximum ratings at 25°C free-air temperature (unless otherwise noted)

	EACH TRIODE	TOTAL DEVICE
Drain-Gate Voltage	50 V	
Reverse Gate-Source Voltage	-50 V	
Gate-1 — Gate-2 Voltage		±100 V
Lead-to-Case Voltage		±100 V
Continuous Forward Gate Current	30 mA	
Continuous Dissipation at (or below) 25°C Free-Air Temperature (See Note 1)	250 mW	400 mW
Storage Temperature Range	-65°C to 200°C	
Lead Temperature 1/8 Inch from Case for 10 Seconds		300°C

NOTE 1: Derate linearly to 175°C free-air temperature at the rate of 1.67 mW/deg for each triode and 2.67 mW/deg for the total device.

*Indicates JEDEC registered data



TEXAS INSTRUMENTS
INCORPORATED
POST OFFICE BOX 5012 • DALLAS, TEXAS 75222

TYPES 2N5045, 2N5046, 2N5047

DUAL N-CHANNEL EPITAXIAL PLANAR SILICON FIELD-EFFECT TRANSISTORS

*electrical characteristics at 25°C free-air temperature (unless otherwise noted)
individual triode characteristics (see note 2)

PARAMETER		TEST CONDITIONS	MIN	MAX	UNIT
I_{GSS}	Gate Reverse Current	$V_{GS} = -50\text{ V}, V_{DS} = 0$		-1	μA
		$V_{GS} = -30\text{ V}, V_{DS} = 0$		-0.25	nA
		$V_{GS} = -30\text{ V}, V_{DS} = 0, T_A = 150^\circ\text{C}$		-250	nA
$V_{GS(off)}$	Gate-Source Cutoff Voltage	$V_{DS} = 15\text{ V}, I_D = 0.5\text{ nA}$	-0.5	-4.5	V
I_{DSS}	Zero-Gate-Voltage Drain Current	$V_{DS} = 15\text{ V}, V_{GS} = 0$	0.5	8	mA
$ y_{fs} $	Small-Signal Common-Source Forward Transfer Admittance	$V_{DS} = 15\text{ V}, V_{GS} = 0, f = 1\text{ kHz}$	1.5	6	mmho
$ y_{os} $	Small-Signal Common-Source Output Admittance	$V_{DS} = 15\text{ V}, V_{GS} = 0, f = 1\text{ kHz}$		25	μmho
C_{iss}	Small-Signal Common-Source Input Capacitance	$V_{DS} = 15\text{ V}, V_{GS} = 0, f = 1\text{ MHz}$		8	pF
C_{rss}	Small-Signal Common-Source Reverse Transfer Capacitance	$V_{DS} = 15\text{ V}, V_{GS} = 0, f = 1\text{ MHz}$		4	pF
$ y_{fs} $	Small-Signal Common-Source Forward Transfer Admittance	$V_{DS} = 15\text{ V}, V_{GS} = 0, f = 100\text{ MHz}$	1.5		mmho

triode matching characteristics

PARAMETER	TEST CONDITIONS	2N5045		2N5046		2N5047		UNIT
		MIN	MAX	MIN	MAX	MIN	MAX	
$ I_{GSS1} - I_{GSS2} $	Gate-Reverse-Current Differential $V_{GS} = -15\text{ V}, V_{DS} = 0, T_A = 100^\circ\text{C}$	10		10		10		nA
$ V_{GS1} - V_{GS2} $	Gate-Source-Voltage Differential $V_{DS} = 15\text{ V}, I_D = 50\text{ }\mu\text{A}$	5		10		15		mV
		5		10		15		mV
$ \Delta(V_{GS1} - V_{GS2})_{\Delta T_A} $	Gate-Source-Voltage-Differential Change with Temperature $V_{DS} = 15\text{ V}, I_D = 200\text{ }\mu\text{A}, T_{A(1)} = 25^\circ\text{C}, T_{A(2)} = -25^\circ\text{C}$	5		10		15		mV
		5		10		15		mV
$\frac{I_{DSS1}}{I_{DSS2}}$	Zero-Gate-Voltage Drain Current Ratio $V_{DS} = 15\text{ V}, V_{GS} = 0, \text{See Note 3}$	0.95	1	0.9	1	0.8	1	
$\frac{ y_{fs1} }{ y_{fs2} }$	Small-Signal Common-Source Forward Transfer Admittance Ratio $V_{DS} = 15\text{ V}, I_D = 200\text{ }\mu\text{A}, f = 1\text{ kHz}, \text{See Note 3}$	0.95	1	0.9	1	0.8	1	
$ y_{os1} - y_{os2} $	Small-Signal Common-Source Output Admittance Differential $V_{DS} = 15\text{ V}, I_D = 200\text{ }\mu\text{A}, f = 1\text{ kHz}$	1		2		3		μmho

*operating characteristics at 25°C free-air temperature
individual triode characteristics (see note 2)

PARAMETER	TEST CONDITIONS	2N5045	2N5046	UNIT
		MAX	MAX	
NF	Spot Noise Figure $V_{DS} = 15\text{ V}, V_{GS} = 0, f = 10\text{ Hz}, R_G = 1\text{ M}\Omega, \text{Noise Bandwidth} = 5\text{ Hz}$	5	5	dB
V_n	Equivalent Input Noise Voltage $V_{DS} = 15\text{ V}, V_{GS} = 0, f = 10\text{ Hz}, \text{Noise Bandwidth} = 5\text{ Hz}$	200	200	nV/Hz ^{1/2}

NOTES: 2. The terminals of the triode not under test are open-circuited for the measurement of these characteristics.

3. The lower of the two characteristic readings is taken as the numerator.

*Indicates JEDEC registered data

TYPES 2N489 THRU 2N494, 2N489A THRU 2N494A, 2N489B THRU 2N494B 2N491A P-N GROWN SILICON UNIJUNCTION TRANSISTORS



TYPES 2N489 THRU 2N494, 2N489A THRU 2N494A, 2N489B THRU 2N494B
 BULLETIN NO. DL-3 683190, OCTOBER 1962
 REVISED MAY 1968

P-N GROWN SILICON UNIJUNCTION TRANSISTORS

Designed for Medium-Power Switching,
Oscillator and Pulse Timing Circuits

- Highly Stable Negative Resistance and Firing Voltage
- Low Firing Current
- High Pulse Current Capabilities
- Simplified Circuit Design

mechanical data

The transistors are hermetically sealed in a welded package with glass-to-metal seal between case and leads. Approximate weight is one gram.

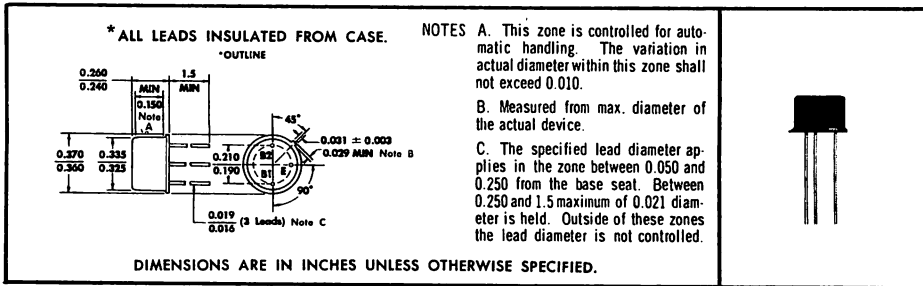

*absolute maximum ratings at 25°C free-air temperature (unless otherwise noted)

Emitter-Base Reverse Voltage below 150°C Junction Temperature	- 60 v
Interbase Voltage	See Note 1
RMS Emitter Current	70 ma
Peak Emitter Current below 150°C Junction Temperature	2 a
Total Device Dissipation at (or below) 25°C Free-Air Temperature (See Note 2)	450 mw
Total Device Dissipation at (or below) 25°C Free-Air Temperature, Stabilized (See Notes 3, 4)	600 mw
Operating Temperature Range	- 65°C to 140°C
Operating Temperature Range, Stabilized (See Note 4)	- 65°C to 175°C
Storage Temperature Range	- 65°C to 175°C
Lead Temperature 1/16 Inch from Case for 10 Seconds	260°C

- NOTES 1. For maximum interbase voltage see Figure 1
2. Derate linearly to 140°C free-air temperature at the rate of 3.9 mw/°C.
3. Derate linearly to 175°C free-air temperature at the rate of 4.0 mw/°C.
4. Total interbase power dissipation must be limited by external circuit.

* Indicates JEDEC registered data.



TEXAS INSTRUMENTS
INCORPORATED
POST OFFICE BOX 5012 • DALLAS, TEXAS 75222

TYPES 2N489 THRU 2N494, 2N489A THRU 2N494A, 2N489B THRU 2N494B P-N GROWN SILICON UNIJUNCTION TRANSISTORS

*electrical characteristics at 25°C free-air temperature (unless otherwise noted)

PARAMETER	TEST CONDITIONS	TYPE	PARENT SERIES		A SERIES		B SERIES		UNIT
			MIN	MAX	MIN	MAX	MIN	MAX	
r_{BB} Static Interbase Resistance	$V_{B2B1} = 3 \text{ v}$, $I_E = 0$	2N489, 2N491, 2N493 2N490, 2N492, 2N494	4.7 6.2	6.8 9.1	4.7 6.2	6.8 9.1	4.7 6.2	6.8 9.1	k Ω
η Intrinsic Standoff Ratio	$V_{B2B1} = 10 \text{ v}$ See Figure 5	2N489, 2N490 2N491, 2N492 2N493, 2N494	0.51 0.56 0.62	0.62 0.68 0.75	0.51 0.56 0.62	0.62 0.68 0.75	0.51 0.56 0.62	0.62 0.68 0.75	
$I_{B2(mod)}$ Modulated Interbase Current	$V_{B2B1} = 10 \text{ v}$, $I_E = 50 \text{ ma}$	All Types	6.8	22	6.8	22	6.8	22	ma
I_{EB2O} Emitter Reverse Current	$V_{B2E} = 60 \text{ v}$, $I_{B1} = 0$	All Types		-2		-2		-2	μa
	$V_{B2E} = 30 \text{ v}$, $I_{B1} = 0$	All Types						-0.2	μa
	$V_{B2E} = 10 \text{ v}$, $I_{B1} = 0$ $T_J = 150^\circ\text{C}$	All Types		-20		-20		-20	μa
I_P Peak-Point Emitter Current	$V_{B2B1} = 25 \text{ v}$	All Types		12		12		6	μa
$V_{EB1(sat)}$ Emitter Base-One Saturation Voltage	$V_{B2B1} = 10 \text{ v}$, $I_E = 50 \text{ ma}$	2N489, 2N490		5.0		4.0		4.0	v
		2N491, 2N492		5.0		4.3		4.3	v
		2N493, 2N494		5.0		4.6		4.6	v
I_V Valley-Point Emitter Current	$V_{B2B1} = 20 \text{ v}$, $R_{B2} = 100 \Omega$	All Types	8		8		8		ma
V_{OB1} Base-One Peak Pulse Voltage	$V_1 = 20 \text{ v}$ $R_{B1} = 20 \Omega$ See Figure 4	All Types			3.0		3.0		v

FIGURE 1—INTERBASE VOLTAGE RATING CURVE

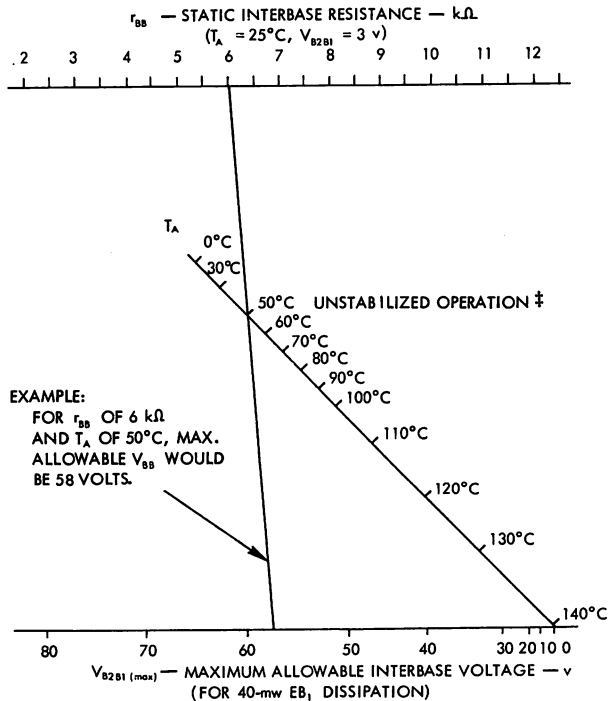

*Indicates JEDEC registered data

TYPES 2N489 THRU 2N494, 2N489A THRU 2N494A, 2N489B THRU 2N494B P-N GROWN SILICON UNIJUNCTION TRANSISTORS

PARAMETER MEASUREMENT INFORMATION

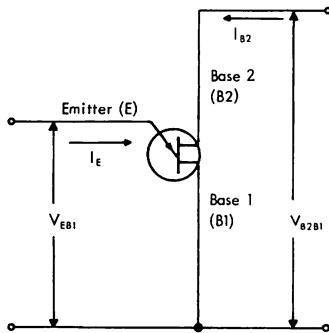

FIGURE 2 — UNIJUNCTION TRANSISTOR NOMENCLATURE

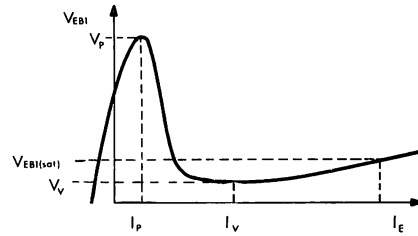

FIGURE 3 — GENERAL STATIC EMITTER CHARACTERISTIC CURVE

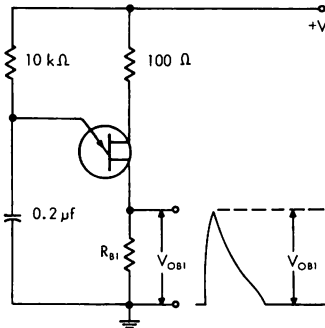

FIGURE 4 — V_{OB1} TEST CIRCUIT

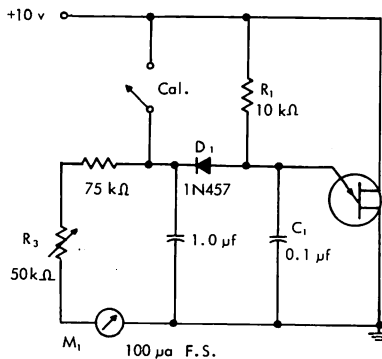

FIGURE 5 — TEST CIRCUIT FOR INTRINSIC STANDOFF RATIO (η)

TEST CIRCUIT FOR INTRINSIC STANDOFF RATIO

η — Intrinsic Standoff Ratio — This parameter is defined in terms of the peak-point voltage, V_P , by means of the equation: $V_P = \eta V_{B2-B1} + V_F$, where V_F is about 0.56 v at 25°C and decreases with temperature at about 3 mv/deg.

The circuit used to measure η is shown in the figure. In this circuit, R_1 , C_1 , and the unijunction transistor form a relaxation oscillator, and the remainder of the circuit serves as a peak-voltage detector with the diode D_1 automatically subtracting the voltage V_F . To use the circuit, the "cal" button is pushed, and R_3 is adjusted to make the current meter M_1 read full scale. The "cal" button then is released and the value of η is read directly from the meter, with $\eta = 1$ corresponding to full-scale deflection of 100 μ a.

TYPES 2N489 THRU 2N494, 2N489A THRU 2N494A, 2N489B THRU 2N494B P-N GROWN SILICON UNIJUNCTION TRANSISTORS

TYPICAL CHARACTERISTICS

NORMALIZED INTERBASE CHARACTERISTICS

Normalized to Value at $V_{B2B1} = 10\text{ v}$, $I_E = 50\text{ ma}$, $T_A = 25^\circ\text{C}$.

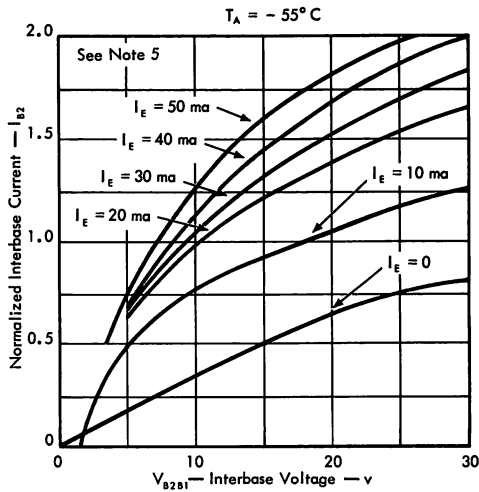
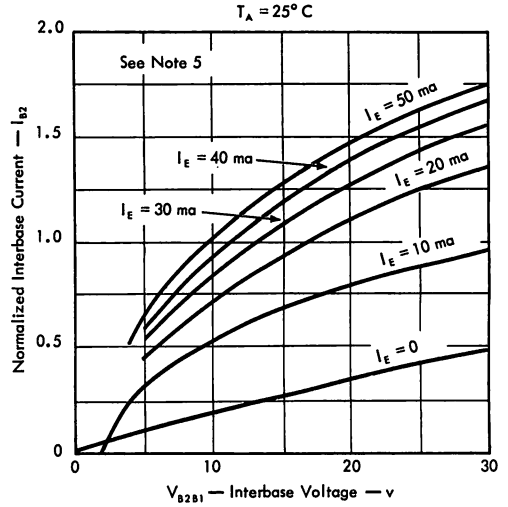
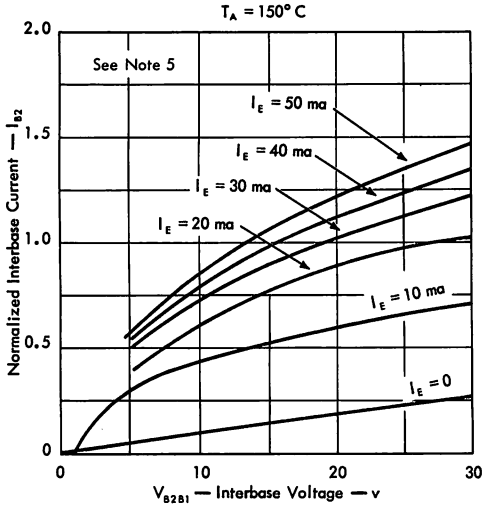

NOTE 5: This parameter is measured using pulse techniques. $t_p = 300\ \mu\text{s}$, duty cycle $\leq 2\%$.

TYPES 2N489 THRU 2N494, 2N489A THRU 2N494A, 2N489B THRU 2N494B P-N GROWN SILICON UNIJUNCTION TRANSISTORS

TYPICAL CHARACTERISTICS

STATIC EMITTER CHARACTERISTICS

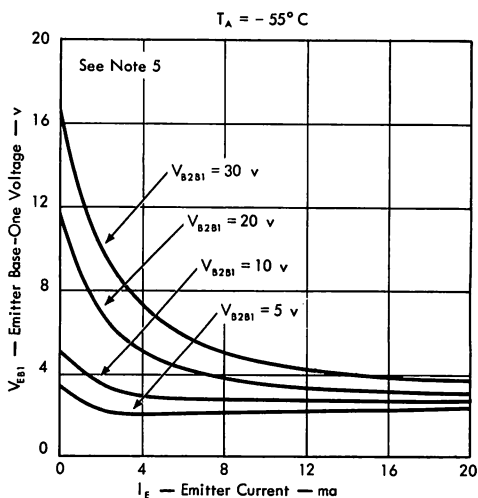
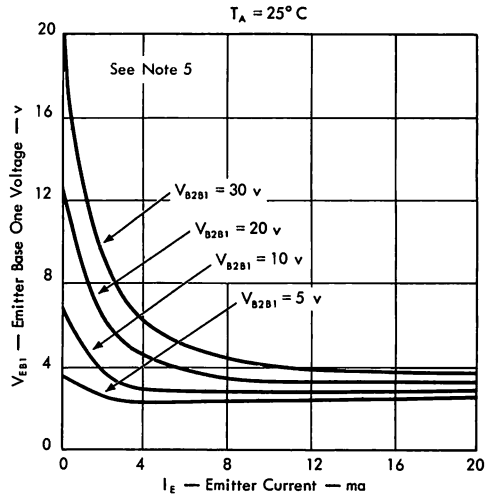
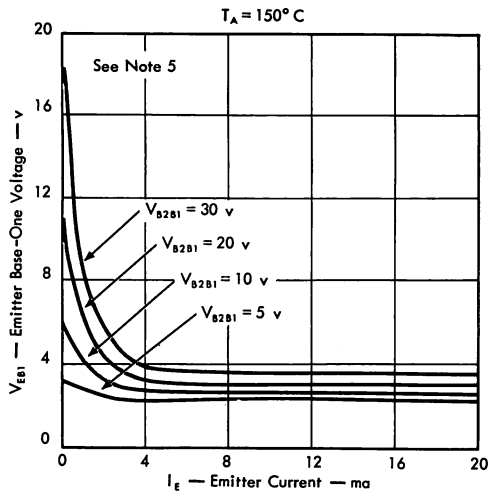

NOTE 5: This parameter is measured using pulse techniques. $t_p = 300\ \mu\text{s}$, duty cycle $\leq 2\%$.

TYPES 2N489 THRU 2N494, 2N489A THRU 2N494A, 2N489B THRU 2N494B P-N GROWN SILICON UNIJUNCTION TRANSISTORS

TYPICAL CHARACTERISTICS

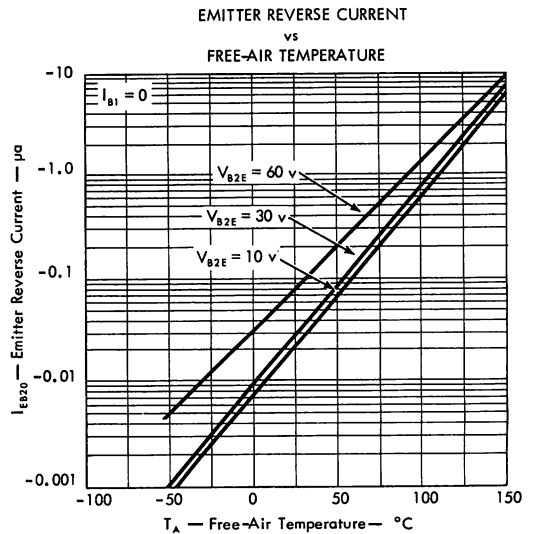
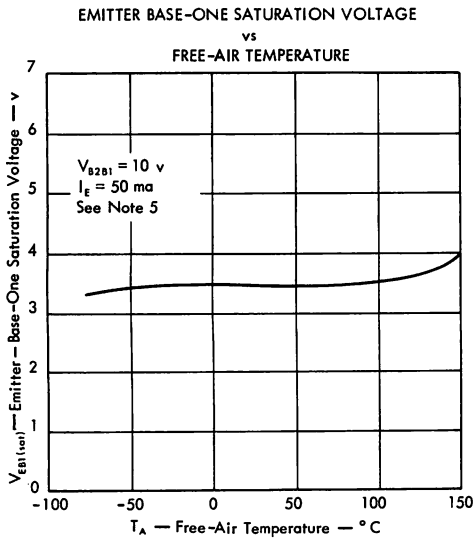
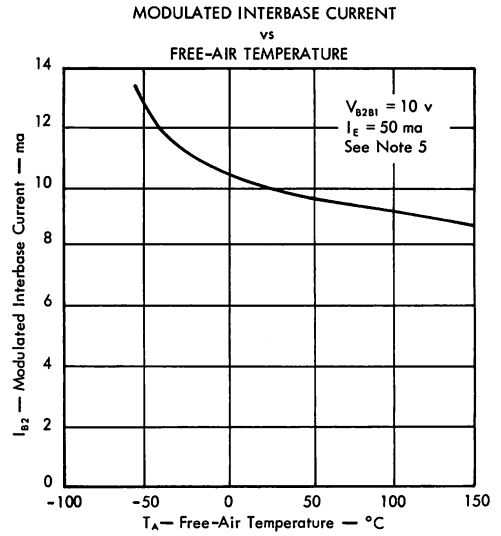
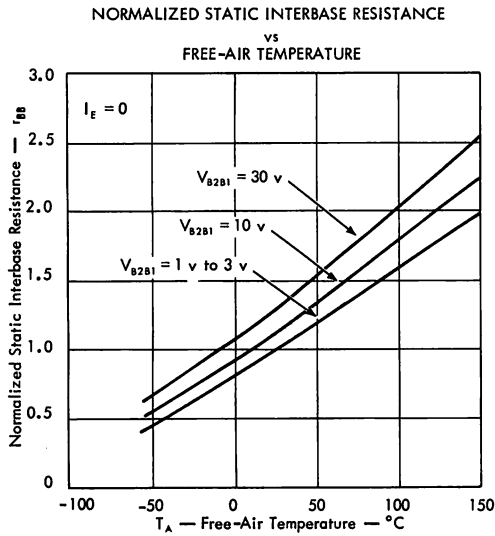

NOTE 5: This parameter is measured using pulse techniques. $t_p = 300 \mu\text{s}$, duty cycle $\leq 2\%$.

TYPES 2N489 THRU 2N494, 2N489A THRU 2N494A, 2N489B THRU 2N494B P-N GROWN SILICON UNIJUNCTION TRANSISTORS

TYPICAL CHARACTERISTICS

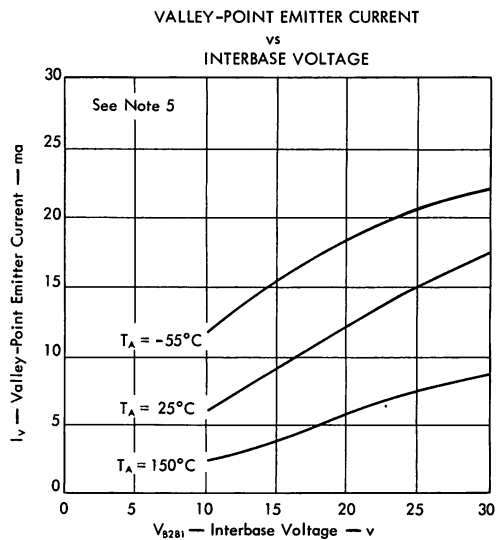
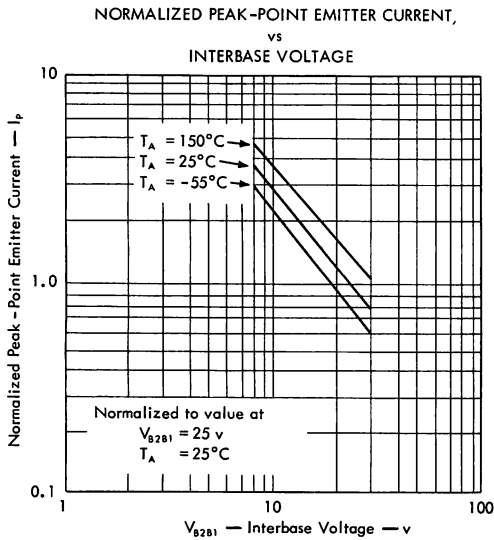
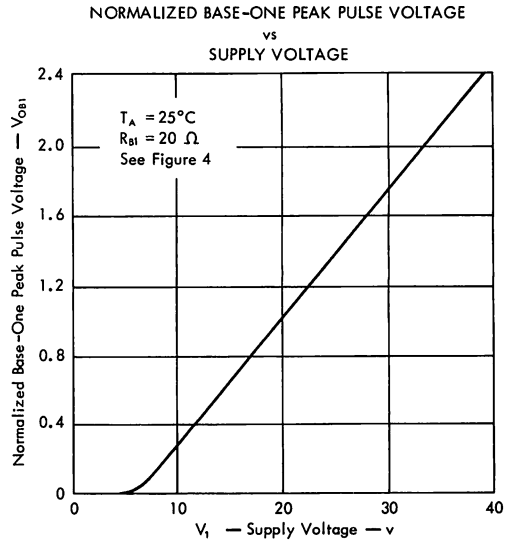
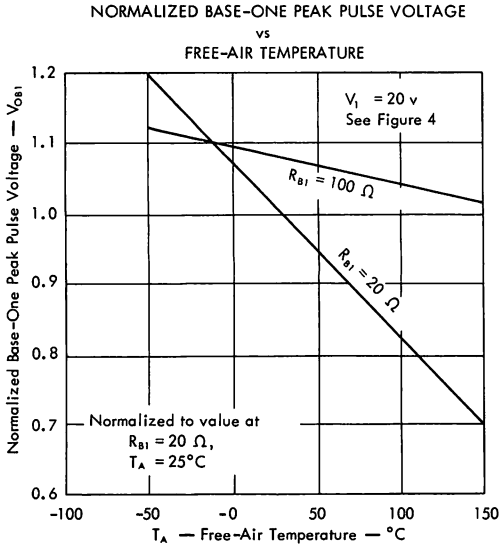

NOTE 5: This parameter is measured using pulse techniques. $I_p = 300 \mu\text{s}$, duty cycle $\leq 2\%$.

TYPES 2N489 THRU 2N494, 2N489A THRU 2N494A, 2N489B THRU 2N494B P-N GROWN SILICON UNIJUNCTION TRANSISTORS

TYPICAL CHARACTERISTICS

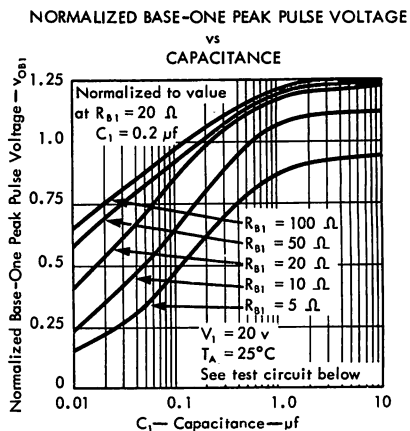
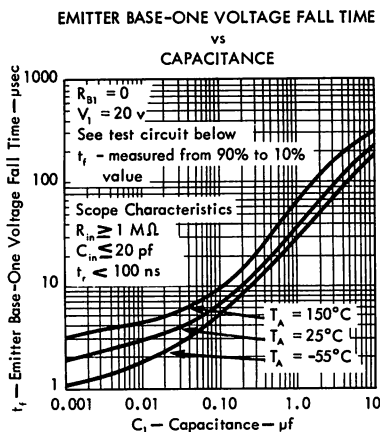

MINIMUM SUPPLY VOLTAGE TO TRIGGER SCR vs CAPACITANCE

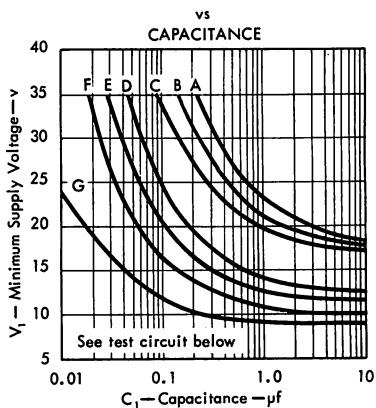

CURVE	SCR TYPE	R_{B1}
A	High-Current SCR's [I_{GT} up to 200 ma V_{GT} up to 3.5 v]	27 Ω
B		47 Ω
C		Pulse Eng PE 2231 †
D	2N681, A, 2N1842, A, B, T1145A0 [I_{GT} up to 150 ma V_{GT} up to 3 v]	27 Ω
E		47 Ω
F		Sprague 31Z204 †
E	2N1595, 2N1600 2N1770, 2N1929 [I_{GT} up to 50 ma V_{GT} up to 3 v]	27 Ω
F		47 Ω
G		Sprague 31Z204 †

† or equivalent

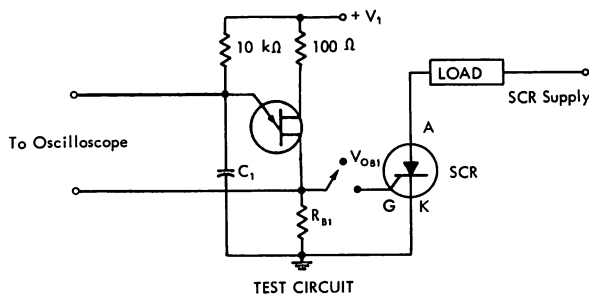

TYPES 2N489 THRU 2N494, 2N489A THRU 2N494A, 2N489B THRU 2N494B P-N GROWN SILICON UNIJUNCTION TRANSISTORS

TYPICAL CHARACTERISTICS

A-C PHASE CONTROL SYSTEM USING 2N491A UNIJUNCTION

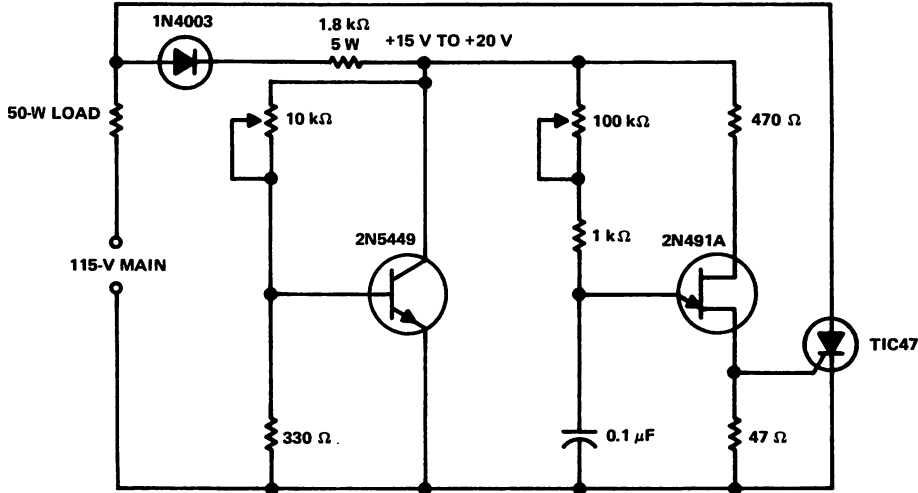

CA17111

CIRCUIT FEATURES

- Unijunction provides accurate and smooth control.
- Half-wave operation conducts from 10° to 170° of waveform.
- 2N5449 acts as zener and synchronizes the 2N491A to line frequency.
- Circuit used as lamp dimmer, relay driver, motor control, or small heater control.

TI Microlibrary Books for Creative Circuit Designers

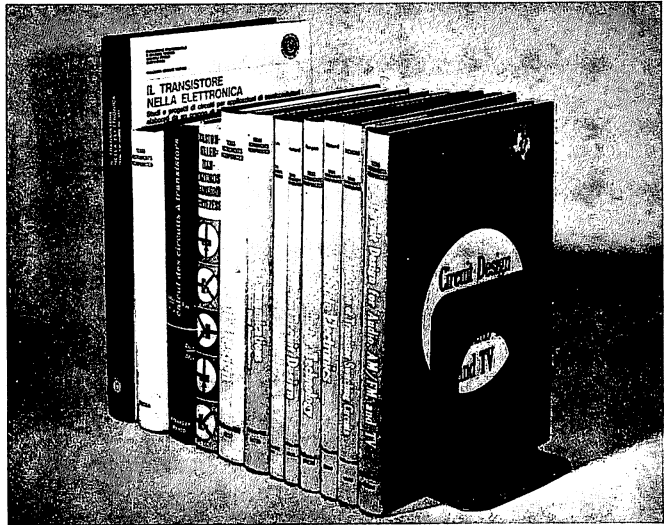

TRANSISTOR CIRCUIT DESIGN

523 Pages • 526 Illustrations • Published January '63 •
Shipping Weight 3-lb 4 oz • \$15.00

FIELD-EFFECT TRANSISTORS • L. J. SEVIN

138 Pages • 137 Illustrations • Published April '65 •
Shipping Weight 1-lb 10-oz • \$10.00

MOSFET IN CIRCUIT DESIGN • ROBERT H. CRAWFORD

136 Pages • 100 Illustrations • Published May '67 •
Shipping Weight 1-lb 10-oz • \$10.00

CIRCUIT DESIGN FOR AUDIO, AM/FM AND TV

352 Pages • 145 Illustrations • Published February '67 •
Shipping Weight 2-lb 8-oz • \$14.50

SILICON SEMICONDUCTOR TECHNOLOGY • W. R. RUNYAN

256 Pages • 301 Illustrations • Published May '65 •
Shipping Weight 2-lb 9-oz • \$16.50

DESIGN AND APPLICATION OF TRANSISTOR SWITCHING CIRCUITS • LOUIS DELHOM

278 Pages • 315 Illustrations • Published January '68 •
Shipping Weight 2-lb • \$14.50

SOLID STATE COMMUNICATIONS

366 Pages • 417 Illustrations • Published April '66 •
Shipping Weight 2-lb 9-oz • \$12.50

SOLID STATE ELECTRONICS • ROBERT G. HIBBERD

170 Pages • 90 Illustrations • Published January '68 •
Shipping Weight 1-lb 12-oz • \$8.95

Terms: F.O.B. destination, bulk rate.
Other than bulk rate,
indicate method of shipment,
add shipping charges.

Outside U.S.: Indicate method of shipment,
add shipping charges.

Send check or money order
(no purchase orders) to:

EXECUTIVE SERVICES DISTRIBUTION
Suite 148
8383 Stemmons Freeway
Dallas, Texas 75247

TYPES 2N1671, 2N1671A, 2N1671B, 2N2160 P-N GROWN SILICON UNIJUNCTION TRANSISTORS



TYPES 2N1671, 2N1671A, 2N1671B, 2N2160
BULLETIN NO. D.L.S. 683189, OCTOBER 1968
REVISED MAY 1968

**Designed for Medium-Power Switching,
Oscillator and Pulse Timing Circuits**

- Highly Stable Negative Resistance and Firing Voltage
- Low Firing Current
- High Pulse Current Capabilities
- Simplified Circuit Design

mechanical data

The transistors are hermetically sealed in a welded package with glass-to-metal seal between case and leads. Approximate weight is one gram.

* ALL LEADS INSULATED FROM CASE.

NOTES A. This zone is controlled for automatic handling. The variation in actual diameter within this zone shall not exceed 0.010.

B. Measured from max. diameter of the actual device.

C. The specified lead diameter applies in the zone between 0.050 and 0.250 from the base seat. Between 0.250 and 1.5 maximum of 0.021 diameter is held. Outside of these zones the lead diameter is not controlled.

DIMENSIONS ARE IN INCHES UNLESS OTHERWISE SPECIFIED

*absolute maximum ratings at 25°C free-air temperature (unless otherwise noted)

	2N1671 2N1671A 2N1671B	2N2160
Emitter-Base Reverse Voltage	- 30 v	
Emitter-Base Reverse Voltage below 140°C Junction Temperature		- 30 v
Interbase Voltage	35 v	35 v
RMS Emitter Current	50 ma	
DC Emitter Current		70 ma
Peak Emitter Current (See Note 1)	2 a	
Peak Emitter Current below 140°C Junction Temperature		2 a
Total Device Dissipation at (or below) 25°C Free-Air Temperature (See Notes 2 & 3)	450 mw	450 mw
Operating Temperature Range (See Note 3)	- 65°C to 140°C	
Storage Temperature Range (See Note 4)	- 65°C to 150°C	
Lead Temperature 1/8 Inch from Case for 10 Seconds	260°C	

- NOTES: 1. Capacitor discharge — 10 μ f or less, 30 volts or less — total interbase power dissipation must be limited by external circuitry.
 2. Derate linearly to 140°C free-air temperature at the rate of 3.9 mw/°C. (2N1671 series only, thermal resistance to case = 0.16°C/mw.)
 3. Texas Instruments guarantees a maximum operating temperature of 175°C free-air. Derate linearly at the rate of 3 mw/°C.
 4. Texas Instruments guarantees a maximum storage temperature of 175°C.

*Indicates JEDEC registered data

TYPES 2N1671, 2N1671A, 2N1671B, 2N2160 P-N GROWN SILICON UNIJUNCTION TRANSISTORS

*electrical characteristics at 25°C free-air temperature

PARAMETER	TEST CONDITIONS	2N1671		2N1671A		2N1671B		2N2160		UNIT
		MIN	MAX	MIN	MAX	MIN	MAX	MIN	MAX	
r_{BB} Static Interbase Resistance	$V_{B2B1} = 3 \text{ v}, I_E = 0$	4.7	9.1	4.7	9.1	4.7	9.1	4.0	12	k Ω
η Intrinsic Standoff Ratio	$V_{B2B1} = 10 \text{ v}$, See Figure 4	0.47	0.62	0.47	0.62	0.47	0.62	0.47	0.80	
$I_{B2(mod)}$ Modulated Interbase Current	$V_{B2B1} = 10 \text{ v}, I_E = 50 \text{ ma}$	6.8	22	6.8	22	6.8	22	6.8	30	ma
I_{EB2O} Emitter Reverse Current	$V_{B2E} = 30 \text{ v}, I_{B1} = 0$		-12		-12		-0.2		-12	μa
I_P Peak-Point Emitter Current	$V_{B2B1} = 25 \text{ v}$		25		25		6		25	μa
$V_{EB1(sat)}$ Emitter Saturation Voltage	$V_{B2B1} = 10 \text{ v}, I_E = 50 \text{ ma}$		5		5		5		5	v
I_V Valley-Point Emitter Current	$V_{B2B1} = 20 \text{ v}, R_{B2} = 100 \Omega$	8		8		8		8		ma
V_{OB1} Base-One Peak Pulse Voltage	$V_1 = 20 \text{ v}, R_{B1} = 20 \Omega$, See Figure 3			3		3		3		v

*Indicates JEDEC registered data

PARAMETER MEASUREMENT INFORMATION

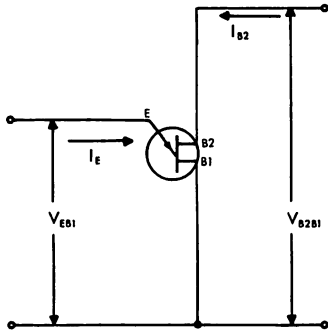

FIGURE 1—UNIUNCTION TRANSISTOR NOMENCLATURE

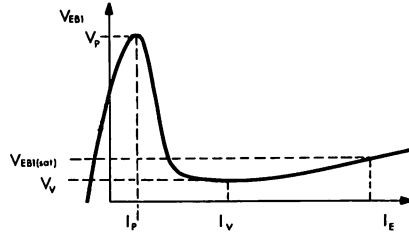

FIGURE 2—GENERAL STATIC EMITTER CHARACTERISTIC CURVE

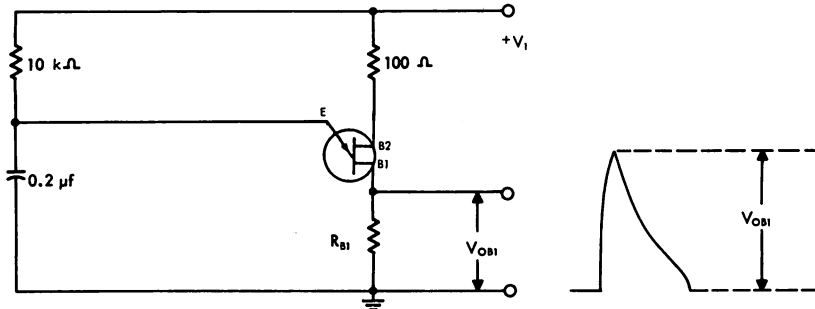
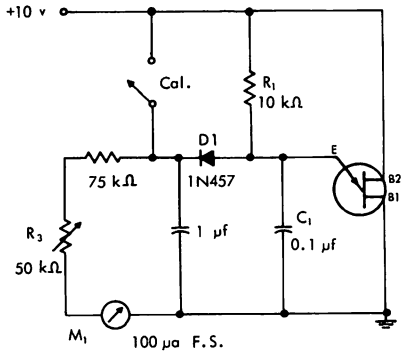

FIGURE 3 — V_{OB1} TEST CIRCUIT

TYPES 2N1671, 2N1671A, 2N1671B, 2N2160 P-N GROWN SILICON UNIJUNCTION TRANSISTORS

PARAMETER MEASUREMENT INFORMATION



η — Intrinsic Standoff Ratio — This parameter is defined in terms of the peak-point voltage, V_p , by means of the equation: $V_p = \eta V_{B2-B1} + V_F$, where V_F is about 0.56 v at 25°C and decreases with temperature at about 3 mv/deg.

The circuit used to measure η is shown in the figure. In this circuit, R_1 , C_1 , and the unijunction transistor form a relaxation oscillator, and the remainder of the circuit serves as a peak-voltage detector with the diode D_1 automatically subtracting the voltage V_F . To use the circuit, the "cal" button is pushed, and R_3 is adjusted to make the current meter M_1 read full scale. The "cal" button then is released and the value of η is read directly from the meter, with $\eta = 1$ corresponding to full-scale deflection of 100 μ a.

FIGURE 4—TEST CIRCUIT FOR INTRINSIC STANDOFF RATIO (η)

TYPICAL CHARACTERISTICS

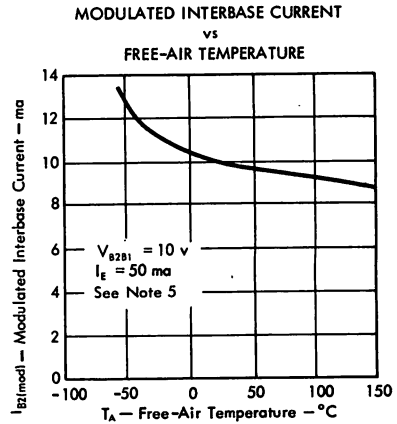
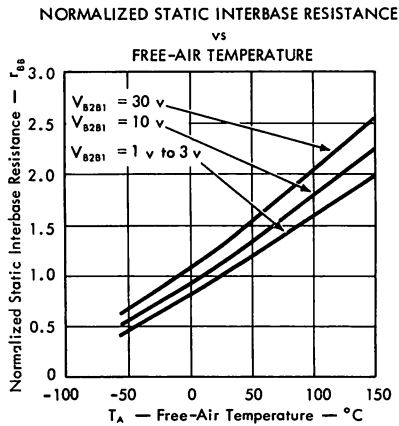

NOTE 5: These parameters must be measured using pulse techniques. $t_p = 300 \mu$ s, duty cycle $\leq 2\%$.

TYPES 2N1671, 2N1671A, 2N1671B, 2N2160 P-N GROWN SILICON UNIJUNCTION TRANSISTORS

TYPICAL CHARACTERISTICS

NORMALIZED INTERBASE CHARACTERISTICS†

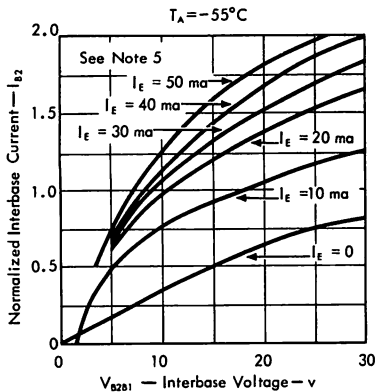
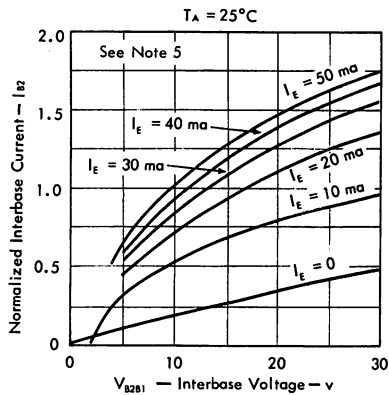
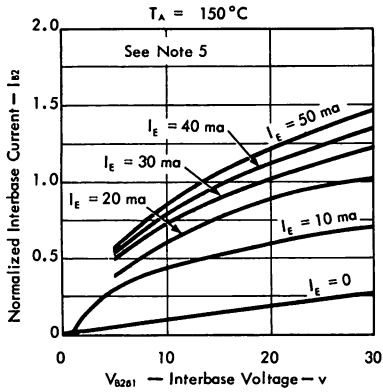

† Normalized to value at $V_{B2B1} = 10\text{ v}$, $I_E = 50\text{ ma}$, $T_A = 25^\circ\text{C}$.

STATIC EMITTER CHARACTERISTICS

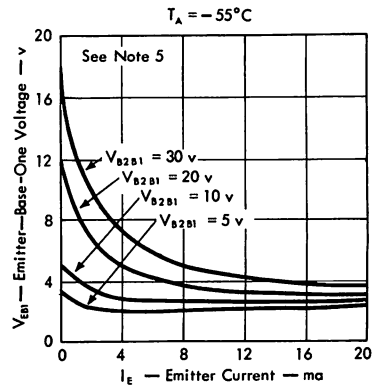
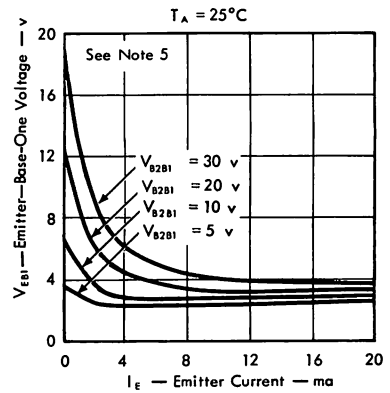
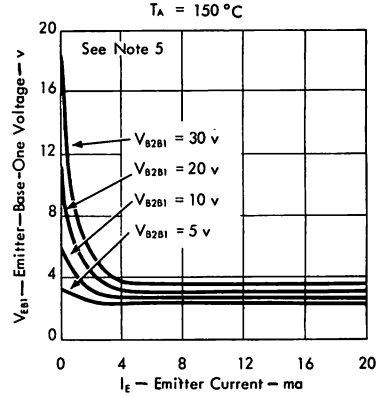

NOTE 5: These parameters must be measured using pulse techniques.
 $t_p = 300\ \mu\text{s}$, duty cycle $\leq 2\%$.

TYPES 2N1671, 2N1671A, 2N1671B, 2N2160 P-N GROWN SILICON UNIJUNCTION TRANSISTORS

TYPICAL CHARACTERISTICS

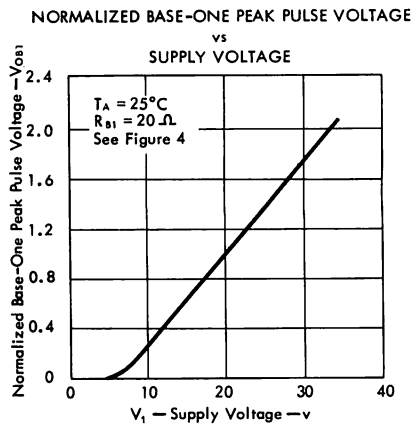
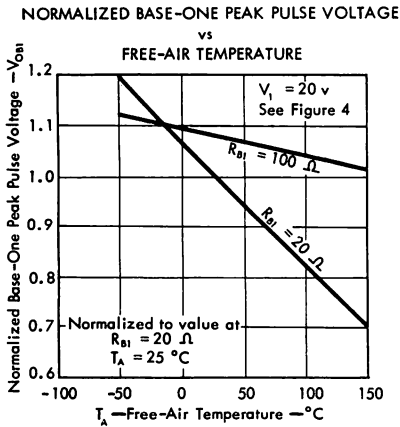
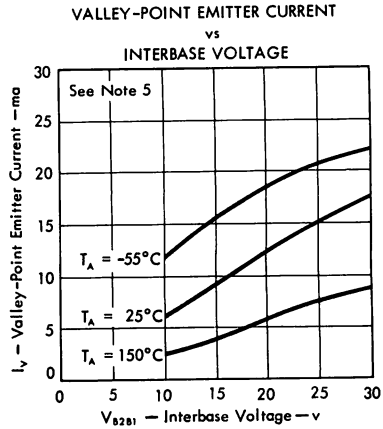
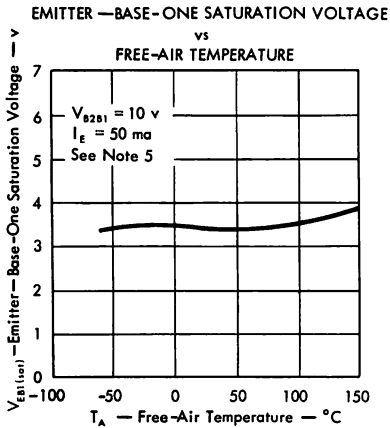
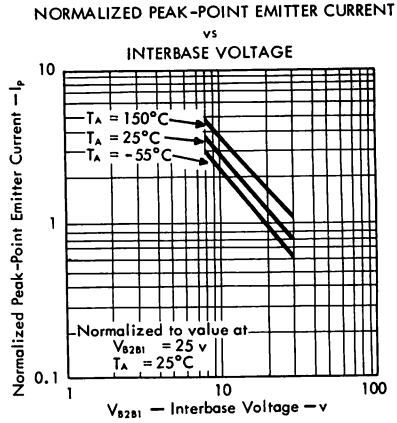
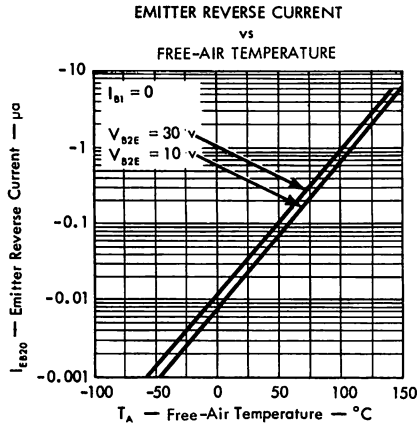

TYPES 2N1671, 2N1671A, 2N1671B, 2N2160 P-N GROWN SILICON UNIJUNCTION TRANSISTORS

TYPICAL APPLICATION DATA

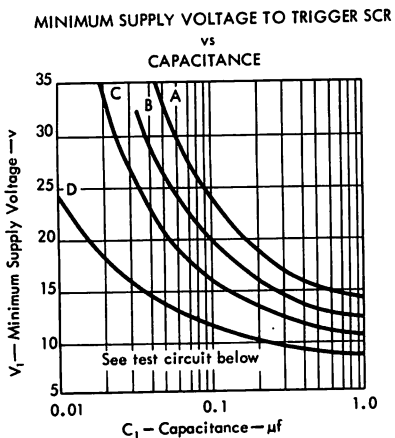
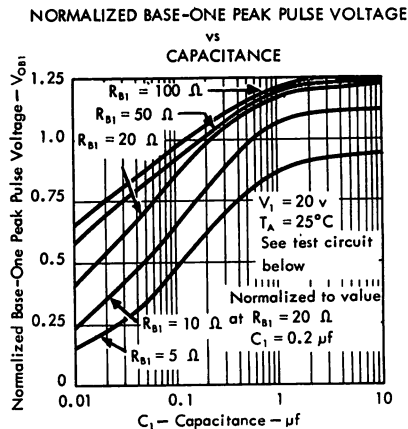
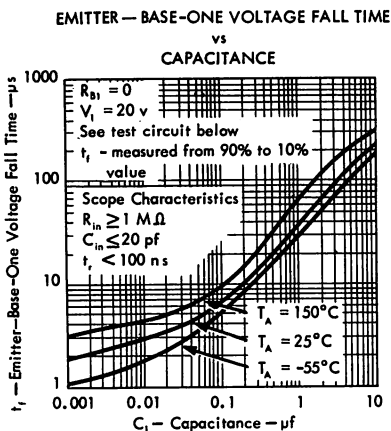

CURVE	SCR TYPE	R_{B1}
A	2N681, A, 2N1842, T1145A0	27 Ω
B		47 Ω
C	I_{GT} up to 150 ma V_{GT} up to 3 v	Sprague 31Z204†
B		27 Ω
C	2N1595, 2N1600 I_{GT} up to 50 ma V_{GT} up to 3 v	47 Ω
D		Sprague 31Z204†

† or equivalent

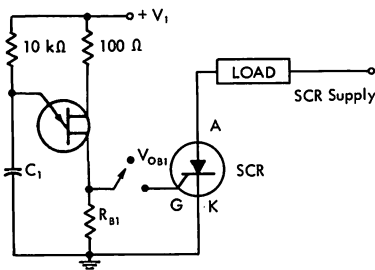

TYPES 2N3980, 2N4947 THRU 2N4949 P-N PLANAR UNIJUNCTION SILICON TRANSISTORS



TYPES 2N3980, 2N4947 THRU 2N4949
 BULLETIN NO. DI-5 679565, MARCH 1967
 REPLACES BULLETIN NO. DI-5 659008, REVISED OCTOBER 1966

PLANAR UNIJUNCTION TRANSISTORS SPECIFICALLY CHARACTERIZED FOR A WIDE RANGE OF MILITARY, SPACE, AND INDUSTRIAL APPLICATIONS:

- 2N3980 for General-Purpose UJT Applications
- 2N4947 for High-Frequency Relaxation-Oscillator Circuits
- 2N4948 for Thyristor (SCR) Trigger Circuits
- 2N4949 for Long-Time-Delay Circuits

- Planar Process Ensures Extremely Low Leakage, High Performance for Low Driving Currents, and Greatly Improved Reliability

*mechanical data

Package outline is same as JEDEC TO-18 except for lead position. All TO-18 registration notes also apply to this outline.

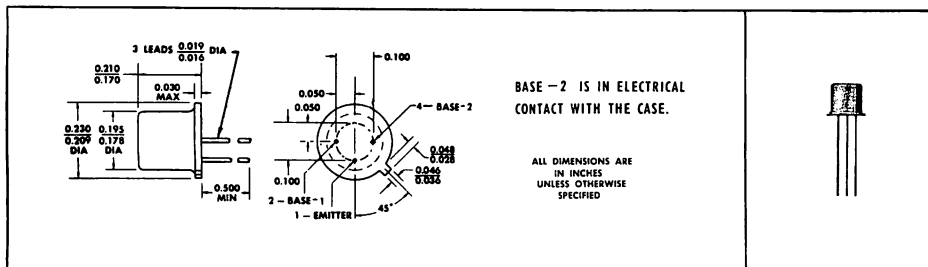

*absolute maximum ratings at 25°C free-air temperature (unless otherwise noted)

Emitter—Base-Two Reverse Voltage	—30 V
Interbase Voltage	See Note 1
Continuous Emitter Current	50 mA
Peak Emitter Current (See Note 2)	1 A
Continuous Device Dissipation at (or below) 25°C Free-Air Temperature (See Note 3)	360 mW
Storage Temperature Range	—65°C to 200°C
Lead Temperature 1/16 Inch from Case for 10 Seconds	260°C

NOTES: 1. Interbase voltage is limited solely by power dissipation, $V_{B2-B1} = \sqrt{t_{BB} \cdot P_T}$

2. This value applies for a capacitor discharge through the emitter—base-one diode. Current must fall to 0.37 A within 3 ms and pulse-repetition rate must not exceed 10 pps.

3. Derate linearly to 175°C free-air temperature at the rate of 2.4 mW/deg.

*Indicates JEDEC registered data

TYPES 2N3980, 2N4947 THRU 2N4949

P-N PLANAR UNIJUNCTION SILICON TRANSISTORS

*electrical characteristics at 25°C free-air temperature (unless otherwise noted)

PARAMETER	TEST CONDITIONS	2N3980		2N4947		2N4948		2N4949		UNIT
		MIN	MAX	MIN	MAX	MIN	MAX	MIN	MAX	
r_{BB} Static Interbase Resistance	$V_{B2-B1} = 3\text{ V}$, $I_E = 0$	4	8	4	9.1	4	12	4	12	k Ω
α_{rBB} Interbase Resistance Temperature Coefficient	$V_{B2-B1} = 3\text{ V}$, $I_E = 0$, $T_A = -65^\circ\text{C}$ to 100°C , See Note 4	0.4	0.9	0.1	0.9	0.1	0.9	0.1	0.9	%/deg
η Intrinsic Standoff Ratio	$V_{B2-B1} = 10\text{ V}$, See Figure 1	0.68	0.82	0.51	0.69	0.55	0.82	0.74	0.86	
$I_{B2(mod)}$ Modulated Interbase Current	$V_{B2-B1} = 10\text{ V}$, $I_E = 50\text{ mA}$, See Note 5	12		12		12		12		mA
I_{EB2O} Emitter Reverse Current	$V_{EB2} = -30\text{ V}$, $I_{B1} = 0$		-10		-10		-10		-10	nA
	$V_{EB2} = -30\text{ V}$, $I_{B1} = 0$, $T_A = 125^\circ\text{C}$		-1		-1		-1		-1	μA
I_P Peak-Point Emitter Current	$V_{B2-B1} = 25\text{ V}$	2		2		2		1		μA
$V_{EB1(sat)}$ Emitter—Base-One Saturation Voltage	$V_{B2-B1} = 10\text{ V}$, $I_E = 50\text{ mA}$, See Note 5	3		3		3		3		V
I_V Valley-Point Emitter Current	$V_{B2-B1} = 20\text{ V}$	1	10	4		2		2		mA
V_{OB1} Base-One Peak Pulse Voltage	See Figure 2	6		3		6		3		V

NOTES: 4. Temperature coefficient α_{rBB} is determined by the following formula:

$$\alpha_{rBB} = \left[\frac{(r_{BB} @ 100^\circ\text{C}) - (r_{BB} @ -65^\circ\text{C})}{r_{BB} @ 25^\circ\text{C}} \right] \frac{100\%}{165 \text{ deg}}$$

To obtain r_{BB} for a given temperature $T_{A(2)}$, use the following formula:

$$r_{BB(2)} = [r_{BB} @ 25^\circ\text{C}] [1 + (\alpha_{rBB}/100\%)(T_{A(2)} - 25^\circ\text{C})]$$

5. These parameters are measured using pulse techniques. $I_P = 300 \mu\text{s}$, duty cycle $\leq 2\%$.

* PARAMETER MEASUREMENT INFORMATION

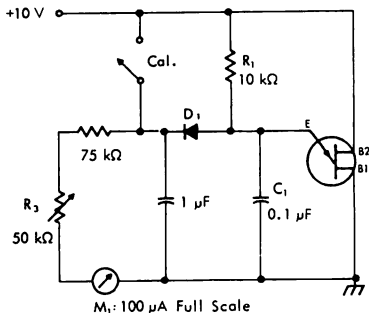

FIGURE 1 — TEST CIRCUIT FOR INTRINSIC STANDOFF RATIO (η)

η — Intrinsic Standoff Ratio — This parameter is defined in terms of the peak-point voltage, V_P , by means of the equation: $V_P = \eta V_{B2B1} + V_F$, where V_F is about 0.56 volt at 25°C and decreases with temperature at about 3 millivolts/deg.

The circuit used to measure η is shown in the figure. In this circuit, R_1 , C_1 and the unijunction transistor form a relaxation oscillator, and the remainder of the circuit serves as a peak-voltage detector with the diode D_1 automatically subtracting the voltage V_F . To use the circuit, the "cal" button is pushed, and R_3 is adjusted to make the current meter M_1 read full scale. The "cal" button then is released and the value of η is read directly from the meter, with $\eta = 1$ corresponding to full-scale deflection of 100 μA .

D_1 : 1N457, or equivalent, with the following characteristics:

$V_F = 0.565\text{ V}$ at $I_F = 50 \mu\text{A}$,

$I_R \leq 2 \mu\text{A}$ at $V_R = 20\text{ V}$

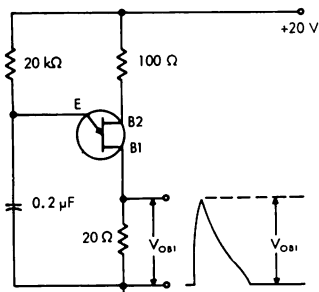

FIGURE 2 — V_{OB1} TEST CIRCUIT

*Indicates JEDEC registered data

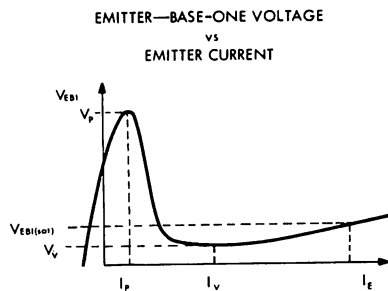

FIGURE 3 — GENERAL STATIC EMITTER CHARACTERISTIC CURVE

TYPES 2N3980, 2N4947 THRU 2N4949 P-N PLANAR UNIJUNCTION SILICON TRANSISTORS

TYPICAL CHARACTERISTICS

2N4947, 2N4948, 2N4949
STATIC INTERBASE RESISTANCE
vs
FREE-AIR TEMPERATURE

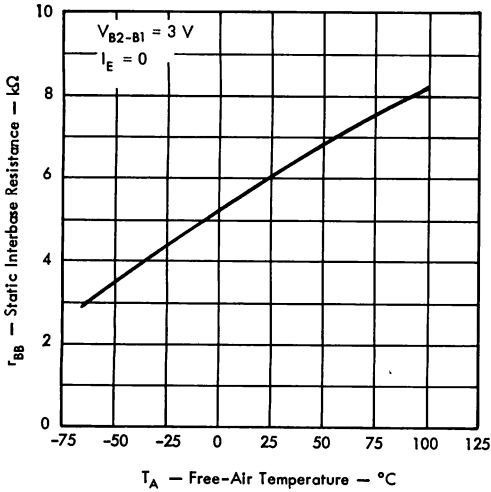

FIGURE 4

EMITTER REVERSE CURRENT
vs
FREE-AIR TEMPERATURE

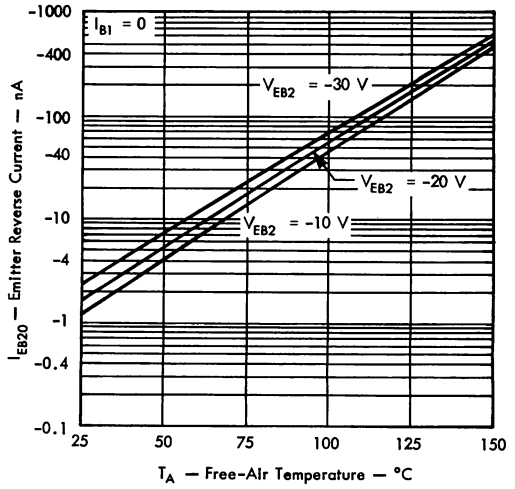

FIGURE 5

2N3980, 2N4948
BASE-ONE PEAK PULSE VOLTAGE
vs
FREE-AIR TEMPERATURE

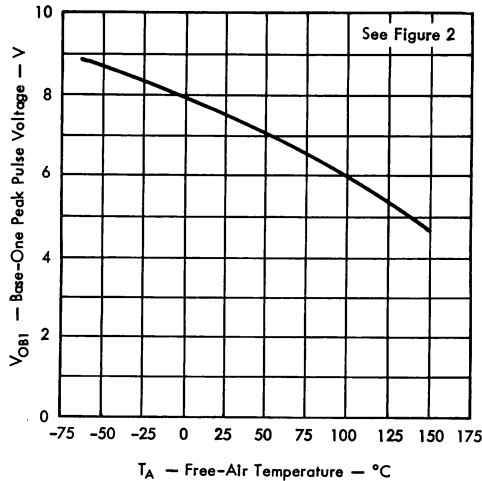

FIGURE 6

TYPES 2N3980, 2N4947 THRU 2N4949

P-N PLANAR UNIJUNCTION SILICON TRANSISTORS

TYPICAL CHARACTERISTICS

MODULATED INTERBASE CURRENT
vs
INTERBASE VOLTAGE

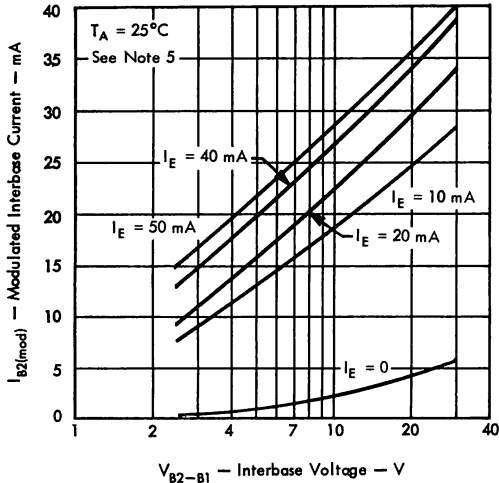

FIGURE 7

MODULATED INTERBASE CURRENT
vs
FREE-AIR TEMPERATURE

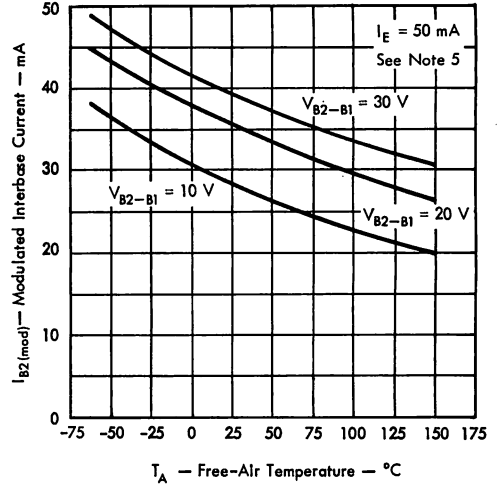

FIGURE 8

2N4949

PEAK-POINT EMITTER CURRENT
vs
FREE-AIR TEMPERATURE

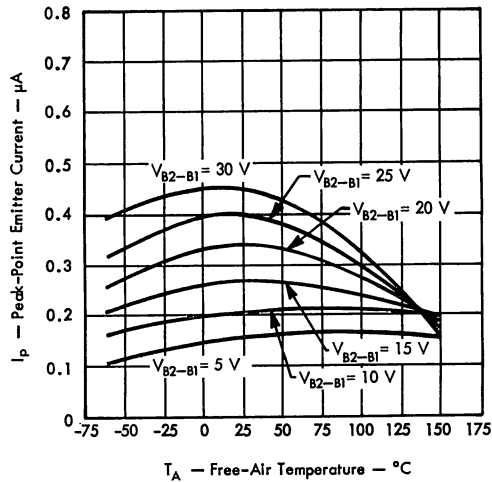

FIGURE 9

NOTES: These parameters are measured using pulse techniques. $t_p = 300\ \mu\text{s}$, duty cycle $\leq 2\%$.

TYPES 2N3980, 2N4947 THRU 2N4949 P-N PLANAR UNIJUNCTION SILICON TRANSISTORS

TYPICAL CHARACTERISTICS

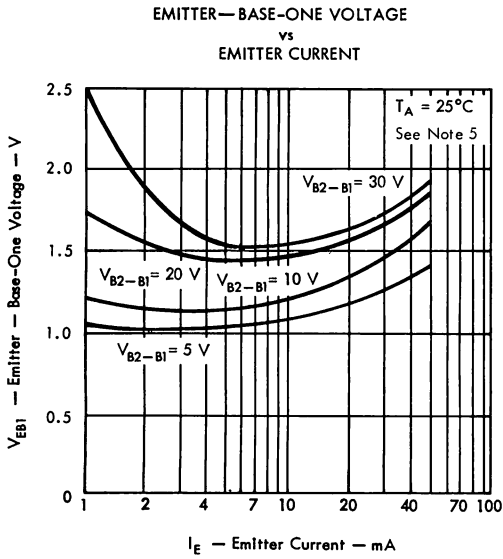

FIGURE 10

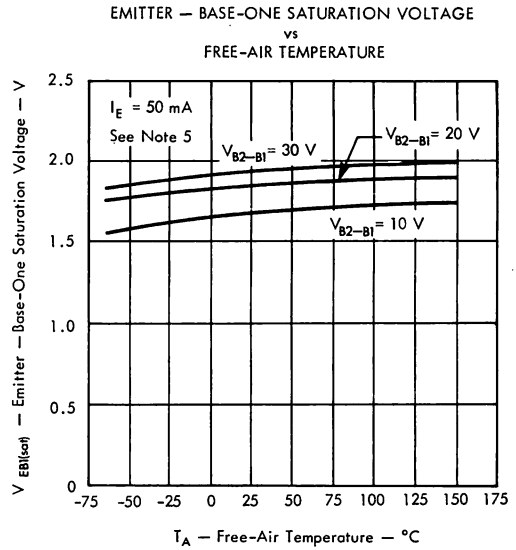

FIGURE 11

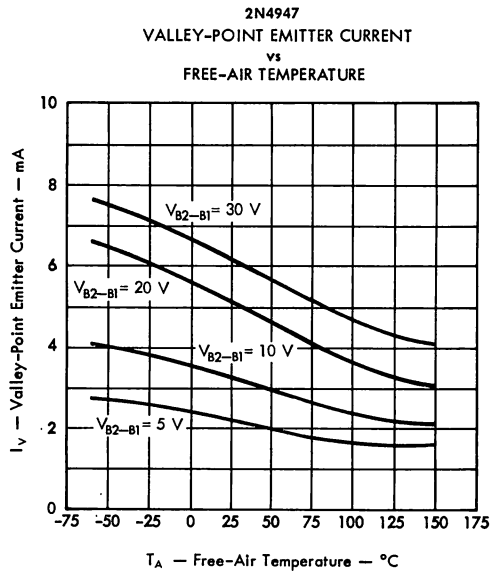

FIGURE 12

NOTE 5: These parameters are measured using pulse techniques. $t_p = 300\ \mu\text{s}$, duty cycle $\leq 2\%$.

TYPES 2N3980, 2N4947 THRU 2N4949 P-N PLANAR UNIJUNCTION SILICON TRANSISTORS

TYPICAL CHARACTERISTICS

TYPICAL MINIMUM SUPPLY VOLTAGE TO TRIGGER THYRISTOR

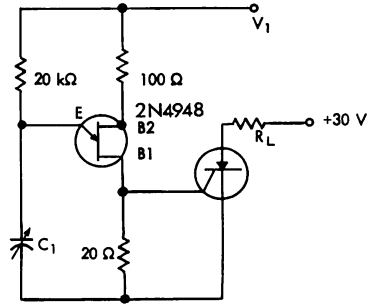
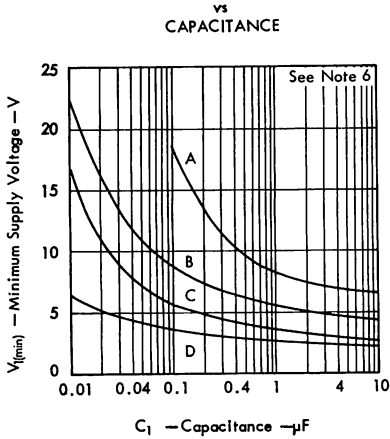

INDEX OF THYRISTOR TYPES

CURVE	THYRISTOR TYPES	R_L
A	T13037-42, 2N3936-40	35 Ω
B	2N681-88, 2N681A-89A, 2N1842B-50B	70 Ω
C	T1145A0-A4, 2N1595-99, T140A0-A5, 2N1600-04, 2N1770-77, 2N2653, T13010, TIC28-31	70 Ω
D	2N3001-08, 2N877-81, 2N885-88, 2N2687-90, 2N3555-62, TIC44-47	70 Ω

FIGURE 13 — OPERATING INFORMATION (2N4948)

NOTE 6: This chart shows typical observed values of minimum base-two supply voltage required to trigger individual thyristors of the types indicated.

TYPES 2N4891 THRU 2N4894 P-N PLANAR UNIJUNCTION SILICON TRANSISTORS



TYPES 2N4891 THRU 2N4894
BULLETIN NO. DI-S-689776, JANUARY 1967
REVISED MAY 1968

PLANAR UNIJUNCTION SILECT† TRANSISTORS SPECIFICALLY CHARACTERIZED FOR A WIDE RANGE OF MILITARY, SPACE AND INDUSTRIAL APPLICATIONS:

- 2N4891 for General Purpose UJT Applications (Replaces TIS43)
- 2N4892 for High-Frequency Relaxation-Oscillator Circuits
- 2N4893 for Thyristor (SCR) Trigger Circuits
- 2N4894 for Long-Time-Delay Circuits

- Planar Process Provides Extremely Low Leakage, High Performance at Low Driving Currents, and Greatly Improved Reliability
- Rugged, One-Piece Construction Features Standard 100-mil TO-18 Pin-Circle

mechanical data

These transistors are encapsulated in a plastic compound specifically designed for this purpose, using a highly mechanized process‡ developed by Texas Instruments. The case will withstand soldering temperatures without deformation. These devices exhibit stable characteristics under high-humidity conditions and are capable of meeting MIL-STD-202C method 106B. The transistors are insensitive to light.

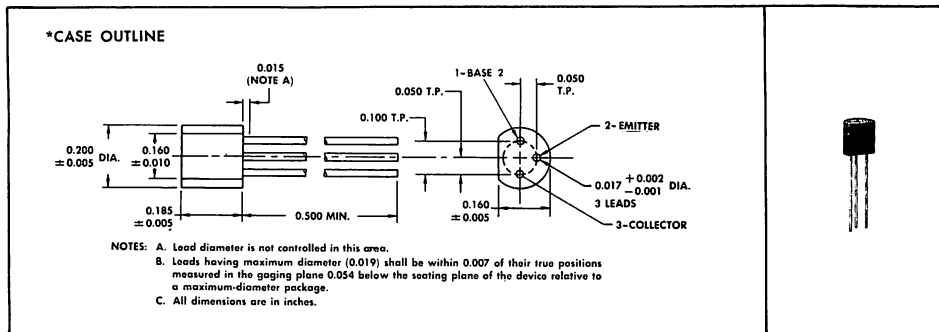

*absolute maximum ratings at 25°C free-air temperature (unless otherwise noted)

Emitter—Base-Two Reverse Voltage	—30 V
Interbase Voltage	See Note 1
Continuous Emitter Current	50 mA
Peak Emitter Current (See Note 2)	1 A
Continuous Device Dissipation at (or below) 25°C Free-Air Temperature (See Note 3)	360 mW
Storage Temperature Range	—65°C to 150°C
Lead Temperature 1/8 Inch from Case for 10 Seconds	260°C

- NOTES: 1. Interbase voltage is limited solely by power dissipation, $V_{B2-B1} = \sqrt{I_{EB} \cdot P_T}$.
2. This value applies for a capacitor discharge through the emitter—base-one diode. Current must fall to 0.37 A within 3 ms and pulse-repetition rate must not exceed 10 pps.
3. Derate linearly to 150°C free-air temperature at the rate of 2.88 mW/deg.

*Indicates JEDEC registered data
†Trademark of Texas Instruments
‡Patent Pending

TYPES 2N4891 THRU 2N4894 P-N PLANAR UNIJUNCTION SILICON TRANSISTORS

*electrical characteristics at 25°C free-air temperature (unless otherwise noted)

PARAMETER	TEST CONDITIONS	2N4891		2N4892		2N4893		2N4894		UNIT	
		MIN	MAX	MIN	MAX	MIN	MAX	MIN	MAX		
r_{BB}	Static Interbase Resistance $V_{B2-B1} = 3 \text{ V}, I_E = 0$	4	9.1	4	9.1	4	12	4	12	k Ω	
α_{rBB}	Interbase Resistance Temperature Coefficient $V_{B2-B1} = 3 \text{ V}, I_E = 0,$ $T_A = -55^\circ\text{C to } 100^\circ\text{C},$	See Note 4		0.1	0.9	0.1	0.9	0.1	0.9	%/deg	
η	Intrinsic Standoff Ratio $V_{B2-B1} = 10 \text{ V},$	See Figure 1		0.55	0.82	0.51	0.69	0.55	0.82	0.74	0.86
$I_{B2(\text{mod})}$	Modulated Interbase Current $V_{B2-B1} = 10 \text{ V}, I_E = 50 \text{ mA},$	See Note 5		10	10	10	10	10	10	mA	
I_{EB2O}	Emitter Reverse Current $V_{EB2} = -30 \text{ V}, I_{B1} = 0$			-10	-10	-10	-10	-10	-10	nA	
I_P	Peak-Point Emitter Current $V_{B2-B1} = 25 \text{ V}$			5	2	2	1	1	1	μA	
$V_{EB1(\text{sat})}$	Emitter-Base-One Saturation Voltage $V_{B2-B1} = 10 \text{ V}, I_E = 50 \text{ mA},$	See Note 5		4	4	4	4	4	4	V	
I_V	Valley-Point Emitter Current $V_{B2-B1} = 20 \text{ V}$			2	4	2	2	2	2	mA	
V_{OB1}	Base-One Peak Pulse Voltage See Figure 2			3	3	6	3	3	3	V	

NOTES: 4. Temperature coefficient, α_{rBB} , is determined by the following formula:

$$\alpha_{rBB} = \left[\frac{r_{BB} @ 100^\circ\text{C} - r_{BB} @ -55^\circ\text{C}}{r_{BB} @ 25^\circ\text{C}} \right] \frac{100\%}{155 \text{ deg}}$$

To obtain r_{BB} for a given temperature $T_{A(2)}$, use the following formula: $r_{BB(2)} = [r_{BB} @ 25^\circ\text{C}] [1 + (\alpha_{rBB}/100) (T_{A(2)} - 25^\circ\text{C})]$

5. These parameters must be measured using pulse techniques. $I_P = 300 \mu\text{s}$, duty cycle $\leq 2\%$.

*Indicates JEDEC registered data.

PARAMETER MEASUREMENT INFORMATION

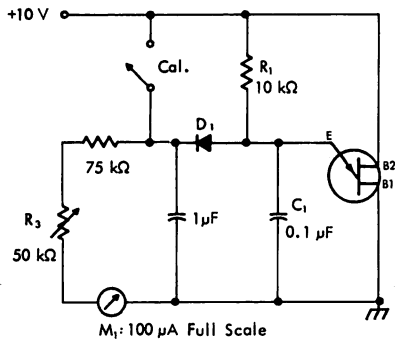

FIGURE 1 — TEST CIRCUIT FOR INTRINSIC STANDOFF RATIO (η)

η — Intrinsic Standoff Ratio — This parameter is defined in terms of the peak-point voltage, V_P , by means of the equation: $V_P = \eta V_{B2B1} + V_F$, where V_F is about 0.56 volt at 25°C and decreases with temperature at about 3 millivolts/deg.

The circuit used to measure η is shown in the figure. In this circuit, R_1 , C_1 and the unijunction transistor form a relaxation oscillator, and the remainder of the circuit serves as a peak-voltage detector with the diode D_1 automatically subtracting the voltage V_F . To use the circuit, the "cal" button is pushed, and R_3 is adjusted to make the current meter M_1 read full scale. The "cal" button then is released and the value of η is read directly from the meter, with $\eta = 1$ corresponding to full-scale deflection of 100 μA .

D_1 : 1N457, or equivalent, with the following characteristics:

$V_F = 0.565 \text{ V at } I_F = 50 \mu\text{A},$

$I_R \leq 2 \mu\text{A at } V_R = 20 \text{ V}$

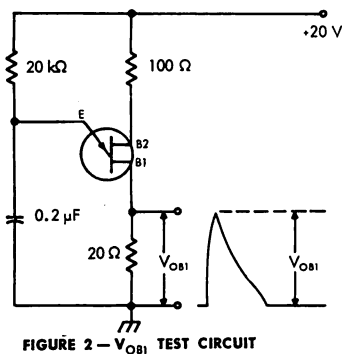

EMITTER-BASE-ONE VOLTAGE
vs
EMITTER CURRENT

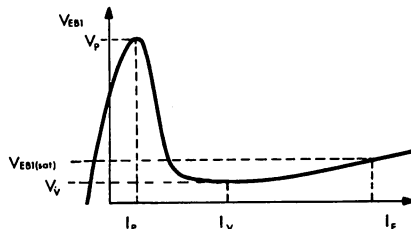

FIGURE 3 — GENERAL STATIC EMITTER CHARACTERISTIC CURVE

TYPES 2N4891 THRU 2N4894 P-N PLANAR UNIJUNCTION SILICON TRANSISTORS

TYPICAL CHARACTERISTICS

STATIC INTERBASE RESISTANCE
vs
FREE-AIR TEMPERATURE

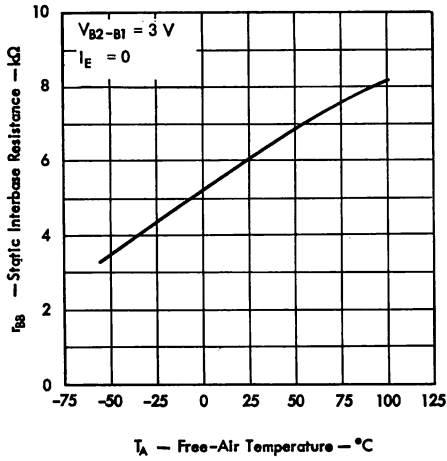

FIGURE 4

EMITTER REVERSE CURRENT
vs
FREE-AIR TEMPERATURE

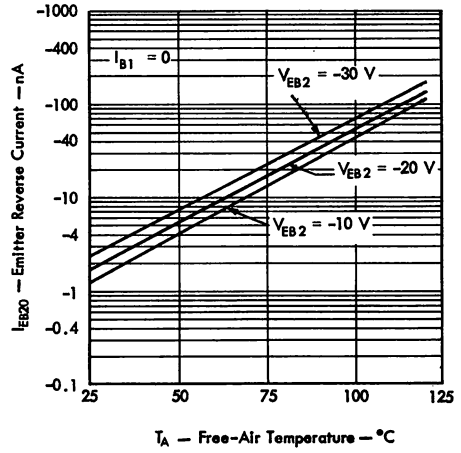

FIGURE 5

2N4893
BASE-ONE PEAK PULSE VOLTAGE
vs
FREE-AIR TEMPERATURE

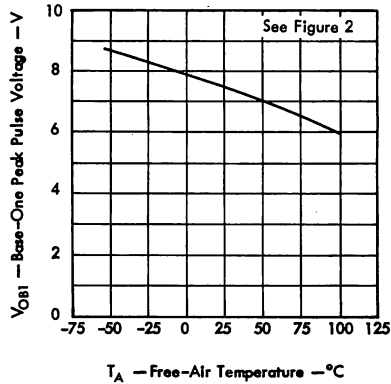

FIGURE 6

TYPES 2N4891 THRU 2N4894

P-N PLANAR UNIJUNCTION SILICON TRANSISTORS

TYPICAL CHARACTERISTICS

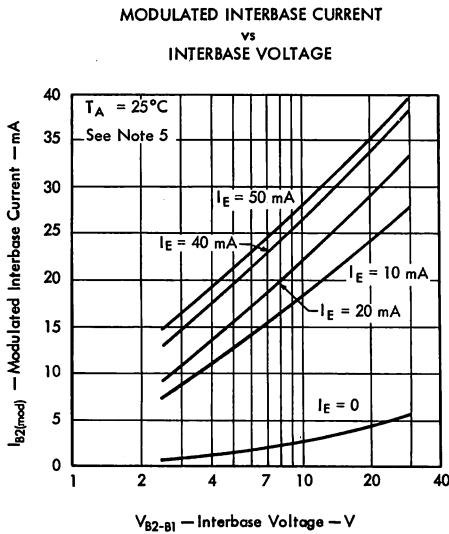

FIGURE 7

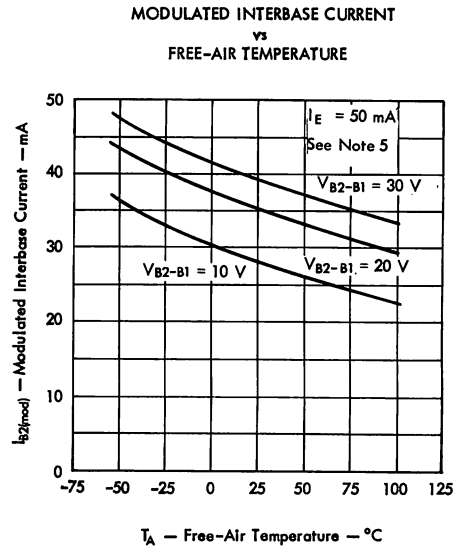

FIGURE 8

2N4894 PEAK-POINT EMITTER CURRENT vs FREE-AIR TEMPERATURE

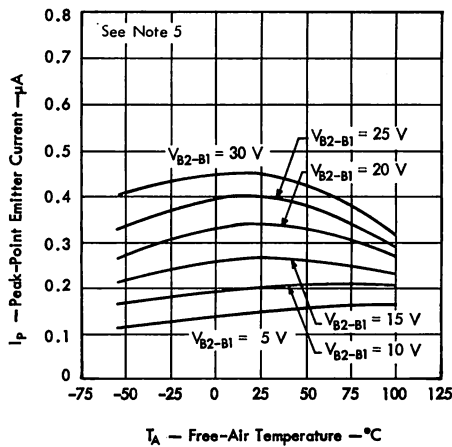

FIGURE 9

NOTE 5: This parameter is measured using pulse techniques. $t_p = 300 \mu s$, duty cycle $\leq 2\%$.

TYPES 2N4891 THRU 2N4894 P-N PLANAR UNIJUNCTION SILICON TRANSISTORS

TYPICAL CHARACTERISTICS

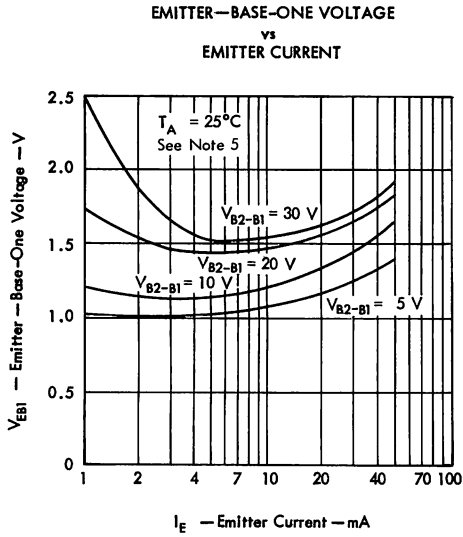

FIGURE 10

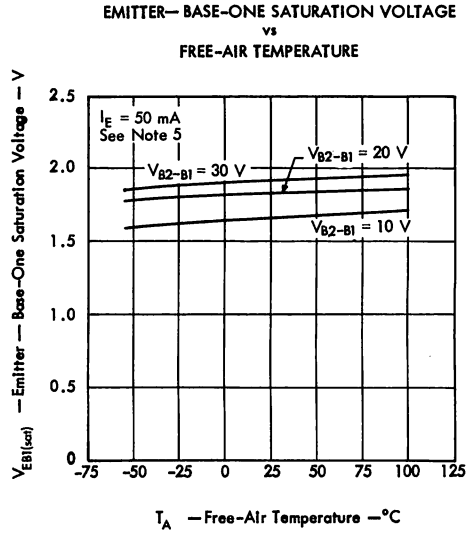

FIGURE 11

2N4892 VALLEY-POINT EMITTER CURRENT vs FREE-AIR TEMPERATURE

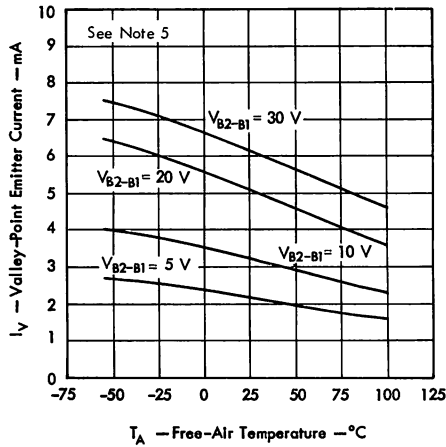

FIGURE 12

NOTE 5: This parameter is measured using pulse techniques. $t_p = 300\ \mu\text{s}$, duty cycle $\leq 2\%$.

TYPES 2N4891 THRU 2N4894 P-N PLANAR UNIJUNCTION SILICON TRANSISTORS

TYPICAL CHARACTERISTICS

TYPICAL MINIMUM SUPPLY VOLTAGE TO TRIGGER THYRISTOR
vs
CAPACITANCE

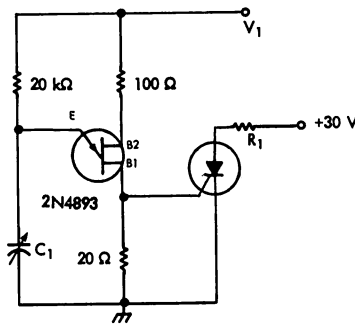
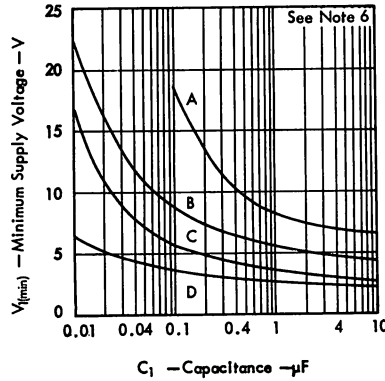

TEST CIRCUIT

INDEX OF THYRISTOR TYPES

CURVE	THYRISTOR TYPES	R ₁
A	T13037-42, 2N3936-40	35 Ω
B	2N681-88, 2N681A-89A, 2N1842B-50B	70 Ω
C	T1145A0-A4, 2N1595-99, T140A0-A5, 2N1600-04, 2N1770-77, 2N2653, T13010, TIC28-31	70 Ω
D	2N3001-08, 2N876-81, 2N884-88, 2N2687-90, 2N3555-62, TIC44-47	70 Ω

FIGURE 13 — OPERATING INFORMATION (2N4893)

NOTE 6: This chart shows typical observed values of minimum base-to supply voltage required to trigger individual thyristors of the types indicated.

TYPES 2N398, 2N398A AND 2N398B P-N-P ALLOY-JUNCTION GERMANIUM TRANSISTORS



TYPES 2N398, 2N398A AND 2N398B
BULLETIN NO. DL-5 622993, AUGUST 1962

High-Voltage Transistors For Direct Control of Neon Indicators

environmental tests

To ensure maximum integrity, stability, and long life, finished devices are subjected to the following tests and conditions prior to thorough testing for rigid adherence to specified characteristics.

- All devices receive a 100°C stabilization bake for 100 hours minimum.
- The hermetic seal is verified by submerging all devices in a 2% detergent solution at 100 psi for 24 hours.
- Production samples are life tested at regularly scheduled periods to ensure maximum reliability under extreme operating conditions.
- Continuous Quality Control checks on in-process assembly are maintained.

*mechanical data

The transistors are in a JEDEC TO-5 hermetically sealed welded package with glass-to-metal seal between case and leads. Approximate weight is one gram.

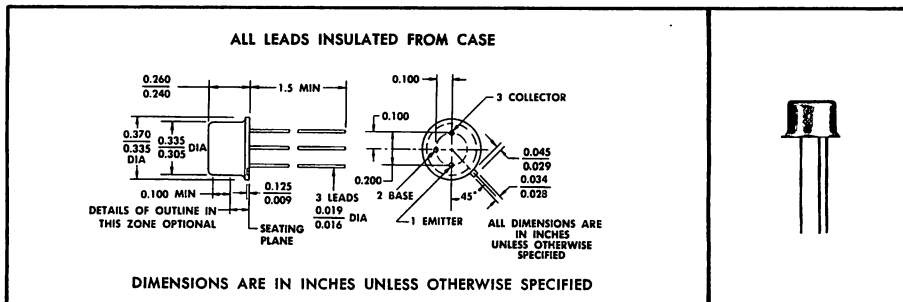

*absolute maximum ratings at 25°C free-air temperature (unless otherwise noted)

	2N398	2N398A	2N398B
Collector-Base Voltage	105 v	105 v	105 v
Collector-Emitter Voltage (See Note 1) . .	105 v	105 v	105 v
Emitter-Base Voltage	50 v	50 v	75 v
Collector Current	100 ma	200 ma	200 ma
Emitter Current	100 ma	200 ma	200 ma
Total Device Dissipation (See Note 2) . . .	50 mw	150 mw	250 mw
Operating Temperature	55°C	100°C	100°C
Storage Temperature Range	-65°C to +85°C	-65°C to +100°C	-65°C to +100°C

NOTES: 1. This value applies when the base-emitter diode is short-circuited.

2. For 2N398 derate linearly to 55°C maximum free-air temperature at the rate of 0.75 mw/°C; this corresponds to 10 mw maximum dissipation at 55°C.

For 2N398A derate linearly to 100°C free-air temperature at the rate of 2.0 mw/°C.

For 2N398B derate linearly to 100°C free-air temperature at the rate of 3.33 mw/°C.

*Indicates JEDEC registered data.



TEXAS INSTRUMENTS
INCORPORATED
POST OFFICE BOX 5012 • DALLAS, TEXAS 75222

TYPES 2N398, 2N398A, AND 2N398B

P-N-P ALLOY-JUNCTION GERMANIUM TRANSISTORS

electrical characteristics at 25°C free-air temperature (unless otherwise noted)

PARAMETER	TEST CONDITIONS	2N398			2N398A			2N398B			UNIT
		MIN*	TYP	MAX*	MIN*	TYP	MAX*	MIN*	TYP	MAX*	
BV_{CBO} Collector-Base Breakdown Voltage	$I_C = -50 \mu a$ $I_E = 0$	-105									v
BV_{EBO} Emitter-Base Breakdown Voltage	$I_E = -50 \mu a$ $I_C = 0$	-50									v
V_{PT} Punch-Through Voltage (See Note 3)	$V_{BEfl} = -1 v$ $R_{BE} = 11 M\Omega$	-105			-105			-105			v
I_{CBO} Collector Cutoff Current	$V_{CB} = -2.5 v$ $I_E = 0$		-6	-14		-6	-14		-4	-6	μa
I_{CBO} Collector Cutoff Current	$V_{CB} = -105 v$ $I_E = 0$					-10	-50		-8	-25	μa
I_{CBO} Collector Cutoff Current	$V_{CB} = -105 v$ $I_E = 0$ $T_A = 71^\circ C$								-180	-300	μa
I_{EBO} Emitter Cutoff Current	$V_{EB} = -2.5 v$ $I_C = 0$		-5			-5			-3	-6	μa
I_{EBO} Emitter Cutoff Current	$V_{EB} = -50 v$ $I_C = 0$		-6			-6	-50				μa
I_{EBO} Emitter Cutoff Current	$V_{EB} = -75 v$ $I_C = 0$								-8	-50	μa
I_{CES} Collector Cutoff Current	$V_{CE} = -105 v$ $V_{BE} = 0$		-60	-600		-60	-600		-40	-300	μa
I_{CER} Collector Cutoff Current	$V_{CE} = -55 v$ $R_{BE} = 10 K\Omega$								-140	-300	μa
h_{FE} Static Forward Current Transfer Ratio	$V_{CE} = -0.35 v$ $I_C = -5 ma$		20	35		20	35				
h_{FE} Static Forward Current Transfer Ratio	$V_{CE} = -0.25 v$ $I_C = -5 ma$								20	45	
V_{BE} Base-Emitter Voltage	$I_B = -0.25 ma$ $I_C = -5 ma$		-0.23	-0.40		-0.23	-0.40		-0.20	-0.30	v
$V_{CE(sat)}$ Collector-Emitter Saturation Voltage	$I_B = -0.25 ma$ $I_C = -5 ma$		-0.14	-0.35		-0.14	-0.35		-0.12	-0.25	v
h_{fo} Small-Signal Common-Emitter Forward Current Transfer Ratio	$V_{CE} = -6 v$ $I_C = -1 ma$ $f = 1 kc$		45			20	45		40	65	
$f_{\alpha ftb}$ Common-Base Alpha-Cutoff Frequency	$V_{CB} = -6 v$ $I_E = 1 ma$		0.8			0.8			1	1.4	mc

3. V_{PT} is determined by measuring the emitter-base floating potential, V_{BEfl} . Collector-base voltage, V_{CB} , is increased until $V_{BEfl} = -1 v$; this value of $V_{CB} = (V_{PT} - 1 v)$.

NORMALIZED STATIC FORWARD CURRENT TRANSFER RATIO

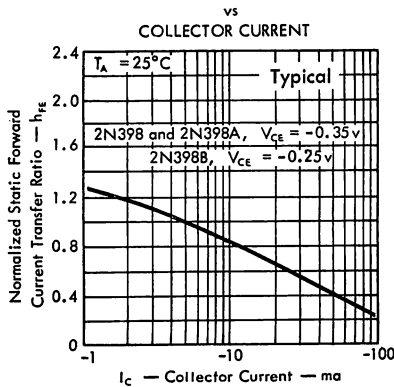

NORMALIZED STATIC FORWARD CURRENT TRANSFER RATIO

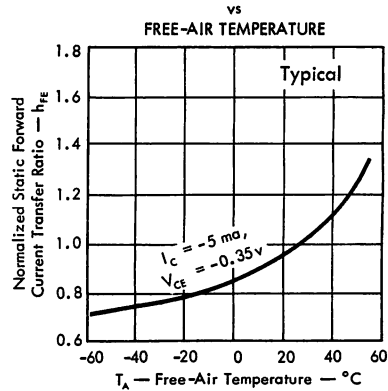

TYPES 2N398, 2N398A, AND 2N398B P-N-P ALLOY-JUNCTION GERMANIUM TRANSISTORS

TYPICAL CHARACTERISTICS

COMMON-EMITTER COLLECTOR CHARACTERISTICS

2N398 and 2N398A

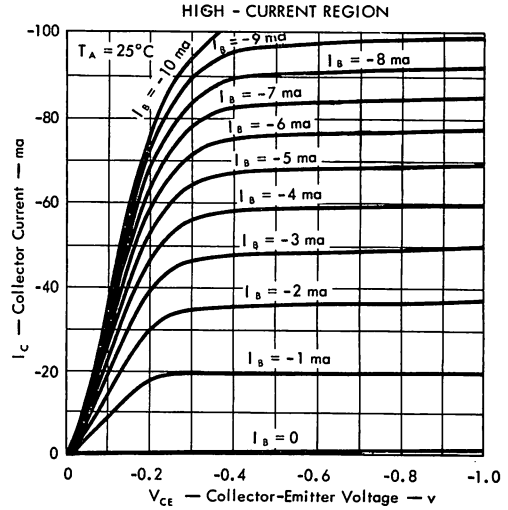
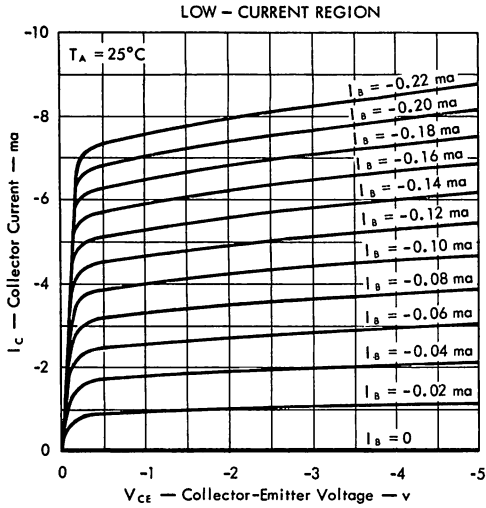

2N398B

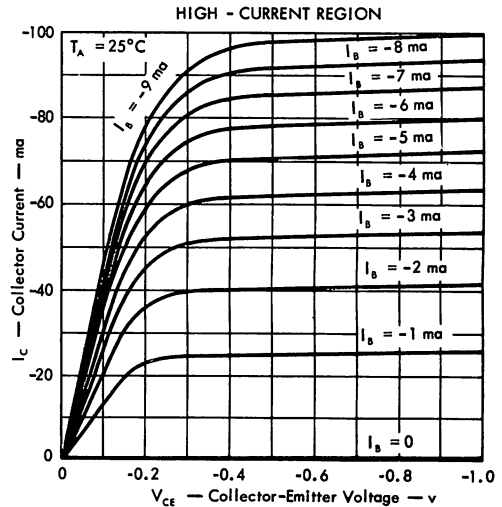
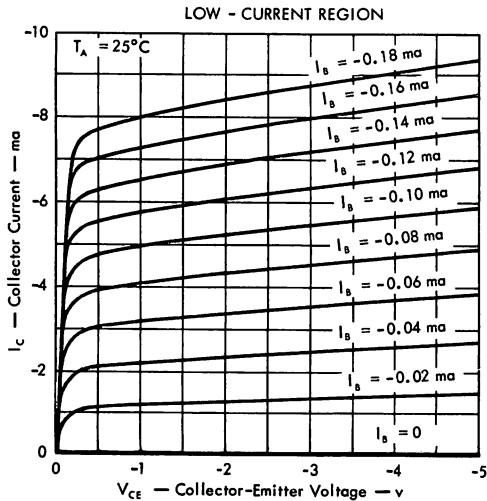

NOTE: These characteristics are measured by the sweep method using Tektronix 575 curve tracer or equivalent.

TYPES 2N398, 2N398A AND 2N398B P-N-P ALLOY-JUNCTION GERMANIUM TRANSISTORS

TYPICAL CHARACTERISTICS

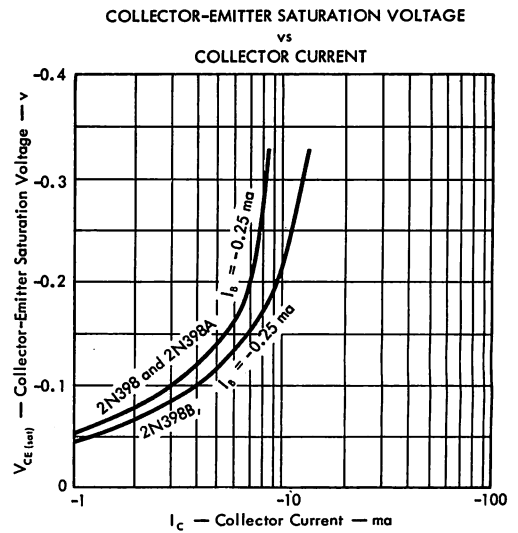
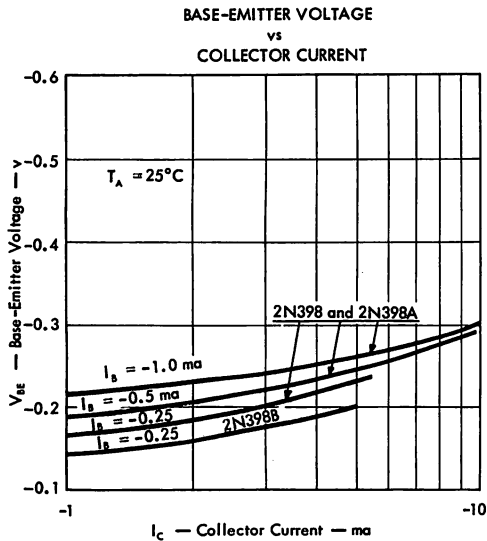
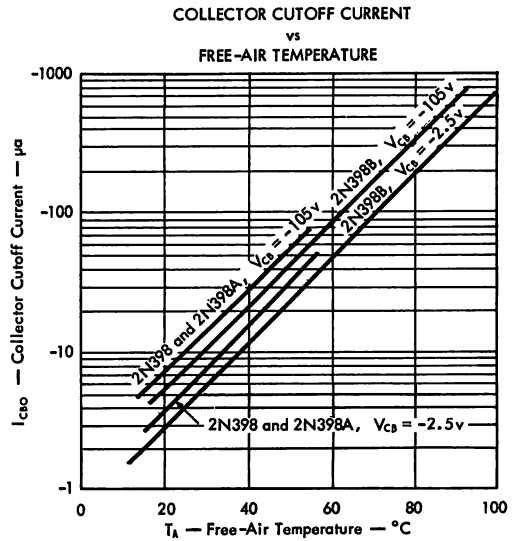
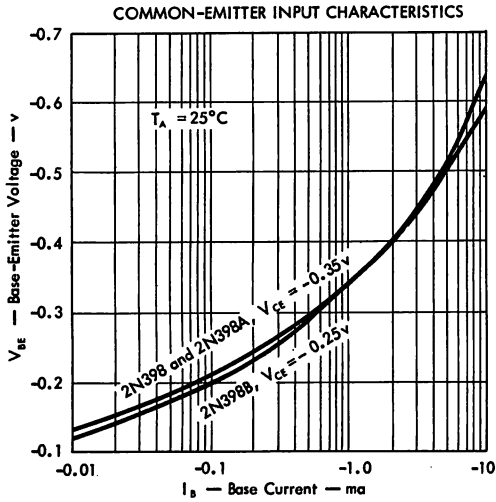



High-Frequency Transistors for Computer and Switching Applications

Close parameter control and the JEDEC TO-5 welded package ensure device reliability and stable characteristics

environmental tests

To ensure maximum reliability, stability, and long life, all units are aged at 100°C for 100 hours minimum prior to electrical characterization. All transistors are thoroughly tested for complete adherence to specified design characteristics. In addition, continuous qualification tests are made comprising temperature-humidity cycling, shock, and vacuum leak testing under rigid in-process control procedures.

mechanical data

Metal case with glass-to-metal hermetic seal between case and leads. Unit weight is approximately 1 gram. These units meet JEDEC TO-5 registration.

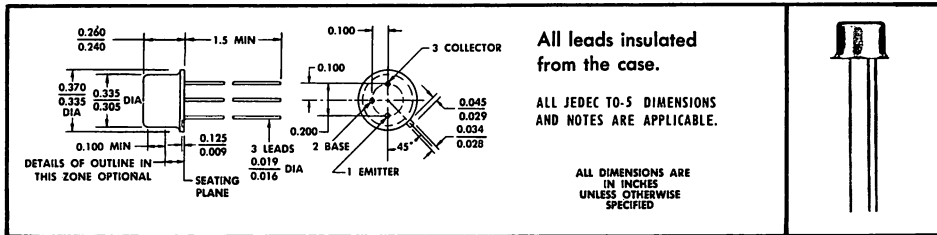

*absolute maximum ratings at 25°C free-air temperature (unless otherwise noted)

	2N404	2N404A
Collector-Base Voltage	25 v	40 v
Collector-Emitter Voltage (see note 1)	24 v	35 v
Emitter-Base Voltage	12 v	25 v
Collector Current	100 ma	150 ma
Emitter Current	100 ma	150 ma
Total Device Dissipation (see note 2)	150 mw	150 mw
Operating Collector Junction Temperature	85°C	100°C
Storage Temperature Range	-65°C to +100°C	-65°C to +100°C

NOTES: 1. Punch-through voltage.
2. For 2N404 derate linearly to 85°C free-air temperature at the rate of 2.5 mw/°C;
For 2N404A derate linearly to 100°C free-air temperature at the rate of 2.0 mw/°C.

*Indicates JEDEC registered data.

The maximum power dissipation at 25°C case temperature is 300 mw.



TYPES 2N404, 2N404A

P-N-P ALLOY-JUNCTION GERMANIUM TRANSISTORS

electrical characteristics at 25°C free-air temperature (unless otherwise noted)

parameter	test conditions	2N404			2N404A			unit
		min	typ	max	min	typ	max	
I_{CBO} Collector cutoff current	$V_{CB} = -12\text{ v}$, $I_E = 0$		-1	-5*		-1	-5*	μA
	$V_{CB} = -12\text{ v}$, $I_E = 0$ $T_A = 80^\circ\text{C}$		-40	-90*		-40	-90*	μA
I_{EBO} Emitter cutoff current	$V_{EB} = -2.5\text{ v}$, $I_C = 0$		-1	-2.5*		-1	-2.5*	μA
BV_{CBO} Collector-base breakdown voltage	$I_C = -20\mu\text{A}$, $I_E = 0$	-25*			-40*			v
BV_{EBO} Emitter-base breakdown voltage	$I_E = -20\mu\text{A}$, $I_C = 0$	-12*			-25*			v
h_{FE} DC forward current transfer ratio	$V_{CE} = -0.15\text{ v}$, $I_C = -12\text{ ma}$	30	100		30	100		
	$V_{CE} = -0.20\text{ v}$, $I_C = -24\text{ ma}$	24	110		24	110		
V_{BE} Base-emitter voltage	$I_B = -0.4\text{ ma}$, $I_C = -12\text{ ma}$		-0.26	-0.35*		-0.26	-0.35*	v
	$I_B = -1\text{ ma}$, $I_C = -24\text{ ma}$		-0.30	-0.40*		-0.30	-0.40*	v
$V_{CE(sat)}$ Collector-emitter saturation voltage	$I_B = -0.4\text{ ma}$, $I_C = -12\text{ ma}$		-0.08	-0.15*		-0.08	-0.15*	v
	$I_B = -1\text{ ma}$, $I_C = -24\text{ ma}$		-0.08	-0.20*		-0.08	-0.20*	v
V_{PT} Punch-through voltage†	$V_{EBF} = -1\text{ v}$	-24*						v
V_{EBF} Emitter-base floating potential	$V_{CB} = -35\text{ v}$					-0.2	-1*	v
h_{fo} AC common-emitter forward current transfer ratio	$V_{CE} = -6\text{ v}$, $I_C = -1\text{ ma}$ $f = 1\text{ kc}$		135			135		
h_{ie} AC common-emitter input impedance	$V_{CE} = -6\text{ v}$, $I_C = -1\text{ ma}$ $f = 1\text{ kc}$		4			4		Kohm
h_{oe} AC common-emitter output admittance	$V_{CE} = -6\text{ v}$, $I_C = -1\text{ ma}$ $f = 1\text{ kc}$		50			50		μmho
h_{re} AC common-emitter reverse voltage transfer ratio	$V_{CE} = -6\text{ v}$, $I_C = -1\text{ ma}$ $f = 1\text{ kc}$		7×10^{-4}			7×10^{-4}		
C_{ob} Common-base output capacitance	$V_{CB} = -6\text{ v}$, $I_E = 0$ $f = 1\text{ mc}$		9	20*				pf
	$V_{CB} = -6\text{ v}$, $I_E = 1\text{ ma}$ $f = 2\text{ mc}$					9	20*	pf
f_{hfb} Common-base alpha cutoff frequency	$V_{CB} = -6\text{ v}$, $I_E = 1\text{ ma}$	4*	12		4*	12		mc

† V_{PT} is determined by measuring the emitter-base floating potential V_{EBF} , using a voltmeter with 11 megohms minimum input impedance. The collector-base voltage, V_{CB} , is increased until $V_{EBF} = -1\text{ v}$; this value of $V_{CB} = (V_{PT} + 1)$. Care must be taken not to exceed maximum collector-base voltage specified under maximum ratings.

switching characteristics at 25°C free-air temperature

parameter	test conditions	2N404			2N404A			unit
		min	typ	max	min	typ	max	
t_d Delay time	See Circuit 1		0.14			0.15		μsec
t_r Rise time	See Circuit 1		0.20			0.27		μsec
t_s Storage time	See Circuit 1		0.38			0.38		μsec
t_f Fall time	See Circuit 1		0.19			0.24		μsec
Q_{ab} Stored base charge	See Circuit 2		800	1400*		800	1400*	pcb

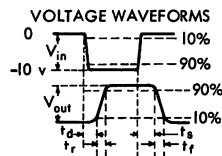
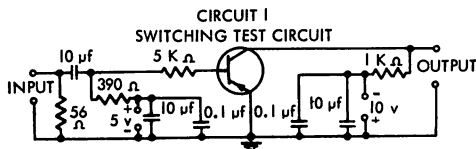

NOTES: 1. Input pulse supplied by generator with following characteristics:

- a. Output impedance: 50 ohms
- b. Repetition rate: 1 kc

2. Waveforms monitored on scope with following characteristics:

- a. Input resistance — 10 megohms minimum

b. Input capacitance — 15 pf maximum

c. Risetime — 15 nanoseconds maximum

3. All resistors $\pm 1\%$ tolerance.

TYPES 2N404, 2N404A

P-N-P ALLOY-JUNCTION GERMANIUM TRANSISTORS

TYPICAL CHARACTERISTICS

COMMON-EMITTER COLLECTOR CHARACTERISTICS . . . AS MEASURED ON TEKTRONIX 575 CURVE TRACER

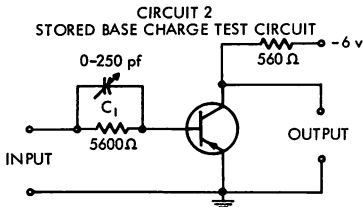
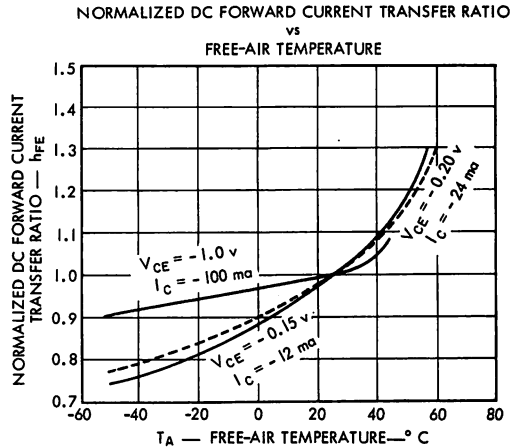
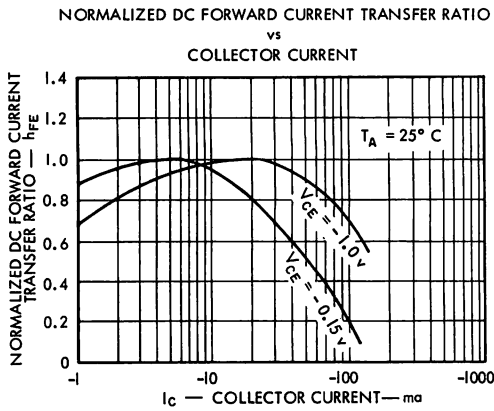
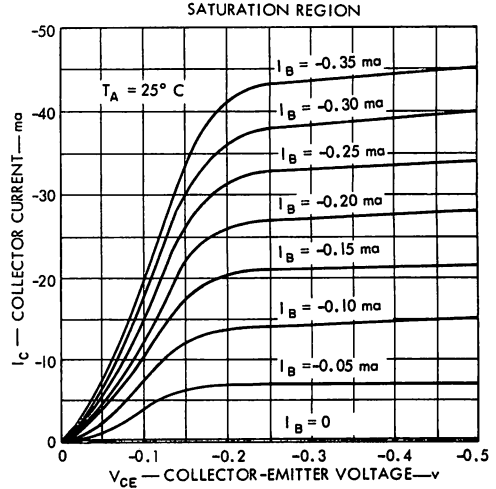
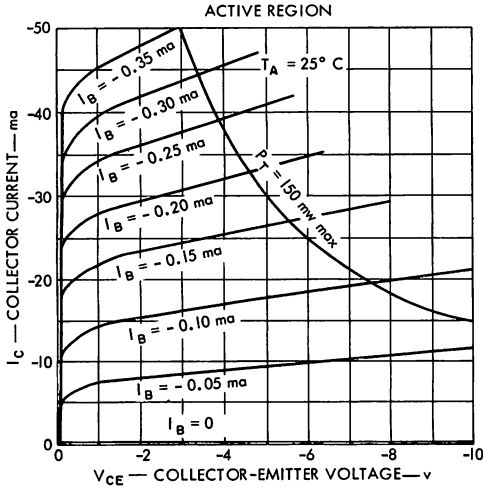

SAME NOTES AS CIRCUIT 1

VOLTAGE WAVEFORMS

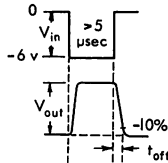

MEASUREMENT PROCEDURE

C_1 is increased until the t_{off} time of the output waveform is decreased to 0.2 μ sec. Q_{sb} is then calculated by $Q_{sb} = C_1 V_{in}$.

TYPES 2N404, 2N404A

P-N-P ALLOY-JUNCTION GERMANIUM TRANSISTORS

TYPICAL CHARACTERISTICS

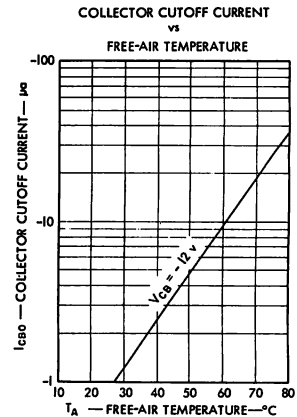
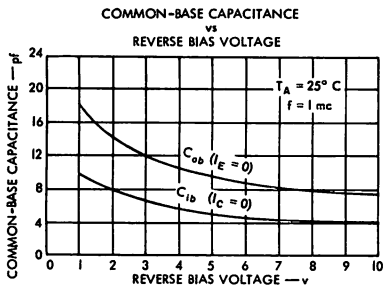
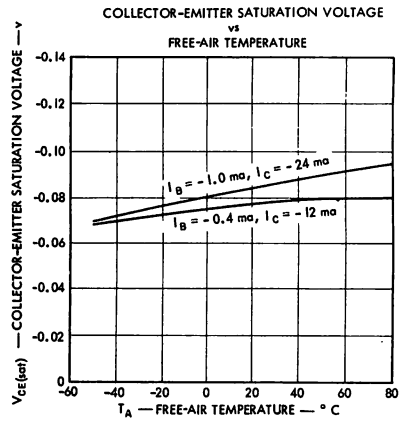
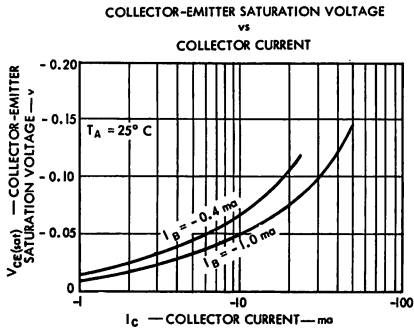
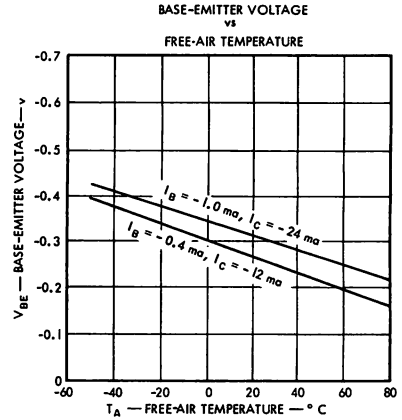
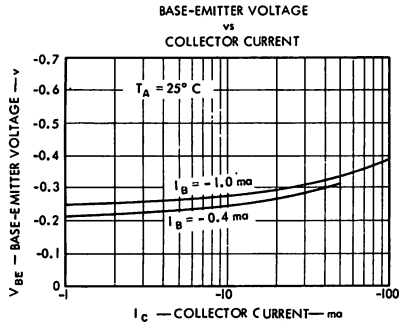

N-P-N TYPES 2N1302, 2N1304, 2N1306, AND 2N1308 P-N-P TYPES 2N1303, 2N1305, 2N1307, AND 2N1309 COMPLEMENTARY ALLOY-JUNCTION GERMANIUM TRANSISTORS



TYPES 2N1302, 2N1304, 2N1306, 2N1308
TYPES 2N1303, 2N1305, 2N1307, 2N1309
BULLETIN NO. DL-5 633149, MARCH 1963
REPLACES BULLETIN NO. DL-5 60349, MAY 1960

High-Frequency Transistors for Computer and Switching Applications

- Complementary Families
- Proven Reliability and Stability

environmental tests

To ensure maximum integrity, stability, and long life, finished devices are subjected to the following tests and conditions prior to thorough testing for rigid adherence to specified characteristics.

- All devices receive a 100°C stabilization bake for 100 hours.
- The hermetic seal for all devices is verified by helium leak testing.
- Production samples are life tested at regularly scheduled periods to ensure maximum reliability under extreme operating conditions.
- Continuous Quality Control checks on in-process assembly are maintained.

*mechanical data

The transistors are in a JEDEC TO-5 hermetically sealed welded package with glass to metal seal between case and leads. Approximate weight is one gram.

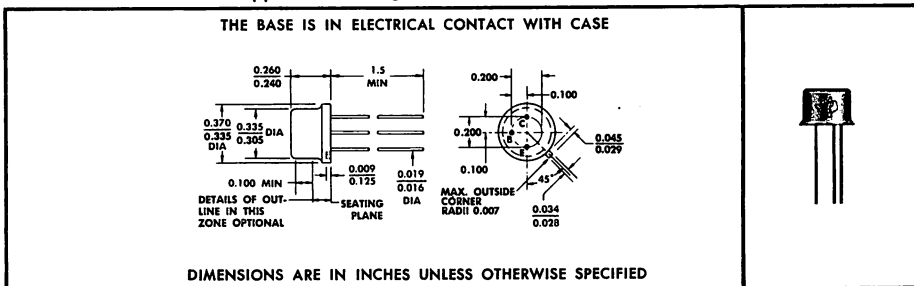

*absolute maximum ratings at 25°C free-air temperature (unless otherwise noted)

	2N1302, 2N1304, 2N1306, 2N1308	2N1303, 2N1305, 2N1307, 2N1309
Collector-Base Voltage	← 25 v →	← 30 v →
Emitter-Base Voltage	← 25 v →	
Collector Current	← 300 ma →	
Total Device Dissipation at (or below) 25°C Free-Air Temperature (See Note 1)	← 150 mw →	
Operating Collector Junction Temperature	← 85°C →	
Storage Temperature Range	← -65°C to 100°C →	

NOTE: 1. Derate linearly to 85°C free-air temperature at the rate of 2.5 mw/°C.

*Indicates JEDEC registered data.



TEXAS INSTRUMENTS
INCORPORATED
POST OFFICE BOX 5012 • DALLAS, TEXAS 75222

TYPES 2N1302, 2N1304, 2N1306, AND 2N1308 N-P-N ALLOY-JUNCTION GERMANIUM TRANSISTORS

electrical characteristics at 25°C free-air temperature

PARAMETER	TEST CONDITIONS	2N1302			2N1304			2N1306			2N1308			UNIT
		MIN	TYP	MAX	MIN	TYP	MAX	MIN	TYP	MAX	MIN	TYP	MAX	
V_{CBO} Collector-Base Breakdown Voltage	$I_C = 100 \mu a, I_E = 0$	25			25			25			25			v
V_{EBO} Emitter-Base Breakdown Voltage	$I_E = 100 \mu a, I_C = 0$	25			25			25			25			v
V_{PT} Punch Through Voltage†	$V_{EBT} = 1 v$	25			20			15			15			v
I_{CBO} Collector Cutoff Current	$V_{CB} = 25 v, I_E = 0$		3	6		3	6		3	6		3	6	μa
I_{EBO} Emitter Cutoff Current	$V_{EB} = 25 v, I_C = 0$		2	6		2	6		2	6		2	6	μa
h_{FE} Static Forward Current Transfer Ratio	$V_{CE} = 1 v, I_C = 10 ma$	20	100		40	115	200	60	130	300	80	160		
	$V_{CE} = 0.35 v, I_C = 200 ma$	10	100		15	110		20	125		20	140		
V_{BE} Base-Emitter Voltage	$I_B = 0.5 ma, I_C = 10 ma$	0.15	0.22	0.40	0.15	0.22	0.35	0.15	0.22	0.35	0.15	0.22	0.35	v
$V_{CE(sat)}$ Collector-Emitter Saturation Voltage	$I_B = 0.5 ma, I_C = 10 ma$		0.07	0.20										v
	$I_B = 0.25 ma, I_C = 10 ma$				0.07	0.20								v
	$I_B = 0.17 ma, I_C = 10 ma$							0.07	0.20					v
	$I_B = 0.13 ma, I_C = 10 ma$										0.07	0.20		v
h_{ib} Small-Signal Common-Base Input Impedance	$V_{CB} = 5 v, I_E = -1 ma, f = 1 kc$		28			28			28			28		ohm
h_{rb} Small-Signal Common-Base Reverse Voltage Transfer Ratio	$V_{CB} = 5 v, I_E = -1 ma, f = 1 kc$		5×10^{-4}			5×10^{-4}			5×10^{-4}			5×10^{-4}		
h_{ob} Small-Signal Common-Base Output Admittance	$V_{CB} = 5 v, I_E = -1 ma, f = 1 kc$		0.34			0.34			0.34			0.34		μmho
h_{fe} Small-Signal Common-Emitter Forward Current Transfer Ratio	$V_{CE} = 5 v, I_C = 1 ma, f = 1 kc$		105			120			135			170		
α_{fcb} Common-Base Alpha-Cutoff Frequency	$V_{CB} = 5 v, I_E = -1 ma$	3	12		5	14		10	16		15	20		mc
C_{ob} Common-Base Open Circuit Output Capacitance	$V_{CB} = 5 v, f = 1 mc, I_E = 0$		14	20		14	20		14	20		14	20	pf
C_{ib} Common-Base Open-Circuit Input Capacitance	$V_{EB} = 5 v, I_C = 0, f = 1 mc$		13			13			13			13		pf

† V_{PT} is determined by measuring the emitter-base floating potential V_{EBT} . The collector-base voltage, V_{CB} , is increased until $V_{EBT} = 1$ volt; this value of $V_{CB} = (V_{PT} + 1 v)$.

switching characteristics at 25°C free-air temperature

PARAMETER	TEST CONDITIONS††	2N1302			2N1304			2N1306			2N1308			UNIT
		MIN	TYP	MAX	MIN	TYP	MAX	MIN	TYP	MAX	MIN	TYP	MAX	
t_d Delay Time	$I_C = 10 ma, I_{B(1)} = 1.3 ma, I_{B(2)} = -0.7 ma, V_{BE(off)} = -0.8 v, R_L = 1 k \Omega$ (See Fig. 1)		0.07			0.07			0.06			0.06		μsec
t_r Rise Time			0.20			0.20			0.18			0.15		μsec
t_s Storage Time			0.70			0.70			0.64			0.64		μsec
t_f Fall Time			0.40			0.40			0.36			0.34		μsec
Q_{sb} Stored Base Charge	$I_{B(1)} = 1 ma, I_C = 10 ma$ (See Fig. 2)		800			760			720			680		pcb

††Voltage and current values shown are nominal; exact values vary slightly with device parameters.

operating characteristics at 25°C free-air temperature

PARAMETER	TEST CONDITIONS	2N1302			2N1304			2N1306			2N1308			UNIT
		MIN	TYP	MAX	MIN	TYP	MAX	MIN	TYP	MAX	MIN	TYP	MAX	
NF Spot Noise Figure	$V_{CB} = 5 v, I_E = -1 ma, f = 1 kc, R_G = 1 k \Omega$		4			4			3			3		db

*Indicates JEDEC registered data (typical values excluded).

TYPES 2N1302, 2N1304, 2N1306, AND 2N1308 N-P-N ALLOY-JUNCTION GERMANIUM TRANSISTORS

TYPICAL CHARACTERISTICS

COMMON-EMITTER COLLECTOR CHARACTERISTICS

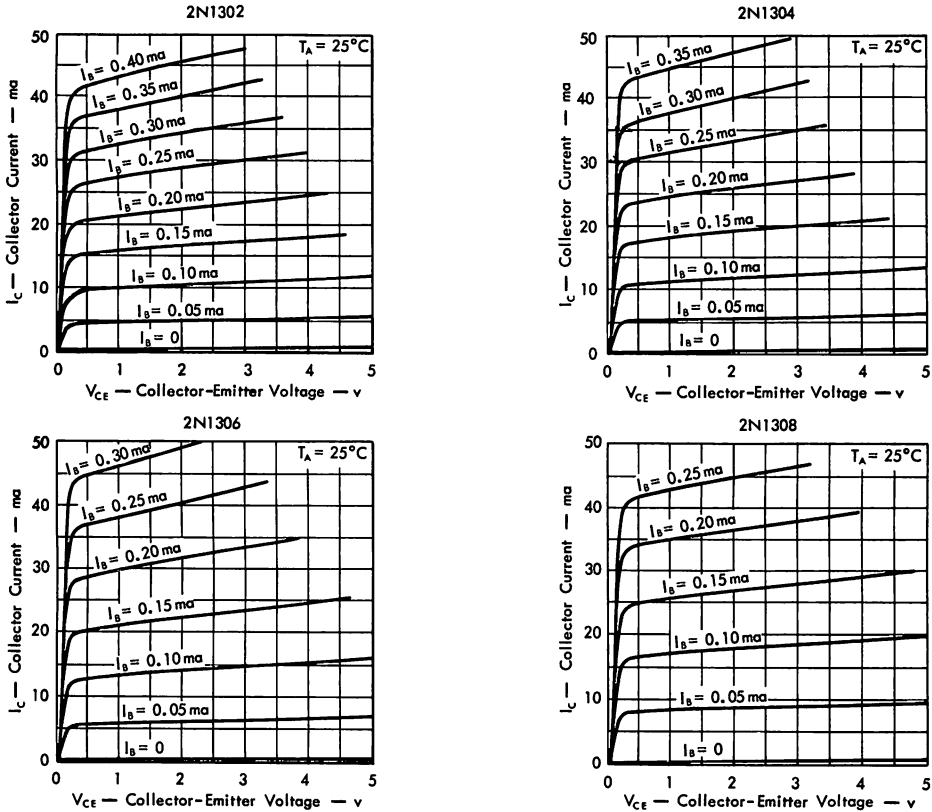

NOTE: These Characteristics are measured by the sweep method using a 575 Tektronix Curve Tracer (or equivalent).

PARAMETER MEASUREMENT INFORMATION

FIGURE 1 SWITCHING TIMES

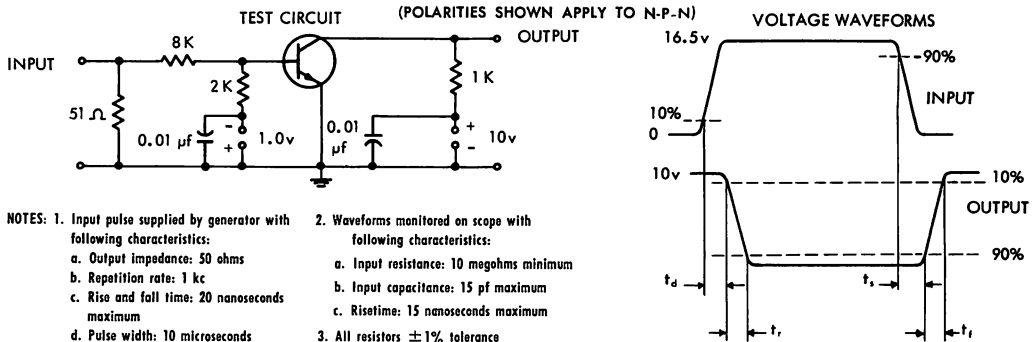

TYPES 2N1303, 2N1305, 2N1307, AND 2N1309

P-N-P ALLOY-JUNCTION GERMANIUM TRANSISTORS

electrical characteristics at 25°C free-air temperature

PARAMETER	TEST CONDITIONS	2N1303			2N1305			2N1307			2N1309			UNIT
		MIN	TYP	MAX	MIN	TYP	MAX	MIN	TYP	MAX	MIN	TYP	MAX	
BV_{CBO} Collector-Base Breakdown Voltage	$I_C = -100 \mu a, I_E = 0$	-30			-30			-30			-30			v
BV_{EBO} Emitter-Base Breakdown Voltage	$I_E = -100 \mu a, I_C = 0$	-25			-25			-25			-25			v
$^*V_{PT}$ Punch Through Voltage†	$V_{EBI} = -1 v$	-25			-20			-15			-15			v
$^*I_{CBO}$ Collector Cutoff Current	$V_{CB} = -25 v, I_E = 0$		-2	-6		-2	-6		-2	-6		-2	-6	μa
$^*I_{EBO}$ Emitter Cutoff Current	$V_{EB} = -25 v, I_C = 0$		-1.5	-6		-1.5	-6		-1.5	-6		-1.5	-6	μa
$^*h_{FE}$ Static Forward Current Transfer Ratio	$V_{CE} = -1 v, I_C = -10 ma$	20	100		40	115	200	60	130	300	80	160		
	$V_{CE} = -0.35 v, I_C = -200 ma$	10	45		15	55		20	65		20	75		
$^*V_{BE}$ Base-Emitter Voltage	$I_B = -0.5 ma, I_C = -10 ma$	-0.15	-0.25	-0.40	-0.15	-0.25	-0.35	-0.15	-0.25	-0.35	-0.15	-0.25	-0.35	v
$^*V_{CE(sat)}$ Collector-Emitter Saturation Voltage	$I_B = -0.5 ma, I_C = -10 ma$		-0.08	-0.20										v
	$I_B = -0.25 ma, I_C = -10 ma$					-0.08	-0.20							v
	$I_B = -0.17 ma, I_C = -10 ma$							-0.08	-0.20					v
	$I_B = -0.13 ma, I_C = -10 ma$										-0.08	-0.20		v
h_{ib} Small-Signal Common-Base Input Impedance	$V_{CB} = -5 v, I_E = 1 ma, f = 1 kc$		29			29			29			29		ohm
h_{rb} Small-Signal Common-Base Reverse Voltage Transfer Ratio	$V_{CB} = -5 v, I_E = 1 ma, f = 1 kc$		7×10^{-4}			7×10^{-4}			7×10^{-4}			7×10^{-4}		
h_{ob} Small-Signal Common-Base Output Admittance	$V_{CB} = -5 v, I_E = 1 ma, f = 1 kc$		0.40			0.40			0.40			0.40		μmho
h_{fe} Small-Signal Common-Emitter Forward Current Transfer Ratio	$V_{CE} = -5 v, I_C = -1 ma, f = 1 kc$		115			130			150			190		
$^*f_{hfb}$ Common-Base Alpha-Cutoff Frequency	$V_{CB} = -5 v, I_E = 1 ma$	3	12		5	14		10	16		15	20		mc
$^*C_{ob}$ Common-Base Open-Circuit Output Capacitance	$V_{CB} = -5 v, I_E = 0, f = 1 mc$		10	20		10	20		10	20		10	20	pf
C_{ib} Common-Base Open-Circuit Input Capacitance	$V_{EB} = -5 v, I_C = 0, f = 1 mc$		9			9			9			9		pf

† V_{PT} is determined by measuring the emitter-base floating potential V_{EBI} . The collector-base voltage, V_{CB} , is increased until $V_{EBI} = -1$ volt; this value of $V_{CB} = (V_{PT} - 1)$.

switching characteristics at 25°C free-air temperature

PARAMETER	TEST CONDITIONS††	2N1303			2N1305			2N1307			2N1309			UNIT	
		MIN	TYP	MAX	MIN	TYP	MAX	MIN	TYP	MAX	MIN	TYP	MAX		
t_d Delay Time	$I_C = -10 ma, I_{B(1)} = -1.3 ma, I_{B(2)} = 0.7 ma, V_{BE(off)} = 0.8 v, R_L = 1 k \Omega$ (See Fig. 1)		0.06			0.06			0.06			0.05		μsec	
t_r Rise Time			0.18			0.18			0.14			0.14		μsec	
t_s Storage Time				0.60			0.80			0.78			0.76		μsec
t_f Fall Time				0.38			0.38			0.36			0.30		μsec
Q_{sb} Stored Base Charge		$I_{B(1)} = -1 ma, I_C = -10 ma$ (See Fig. 2)		960			920			880			800		pcb

††Voltage and current values shown are nominal, exact values vary slightly with device parameters.

operating characteristics at 25°C free-air temperature

PARAMETER	TEST CONDITIONS	2N1303			2N1305			2N1307			2N1309			UNIT
		MIN	TYP	MAX	MIN	TYP	MAX	MIN	TYP	MAX	MIN	TYP	MAX	
NF Spot Noise Figure	$V_{CB} = -5 v, I_E = 1 ma, f = 1 kc, R_G = 1 k \Omega$		4			4			3			3		db

*Indicates JEDEC registered data (typical values excluded).

TYPES 2N1303, 2N1305, 2N1307, AND 2N1309 P-N-P ALLOY-JUNCTION GERMANIUM TRANSISTORS

TYPICAL CHARACTERISTICS

COMMON-EMITTER COLLECTOR CHARACTERISTICS

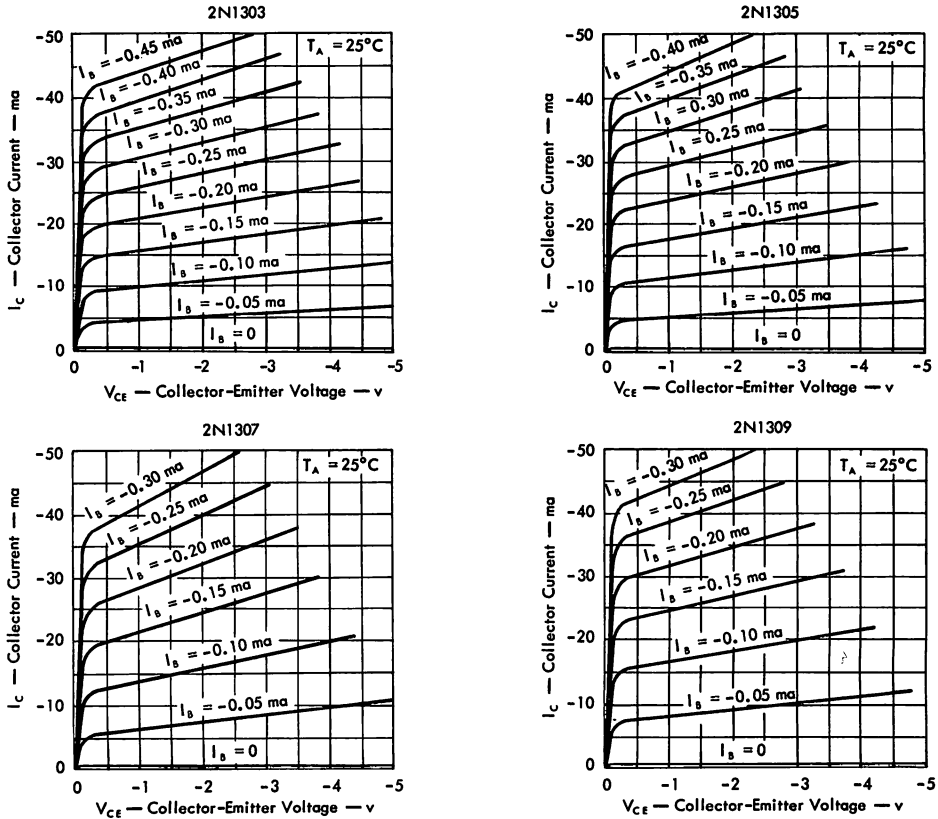

PARAMETER MEASUREMENT INFORMATION

FIGURE 2
STORED BASE CHARGE

(POLARITIES SHOWN APPLY TO P-N-P)

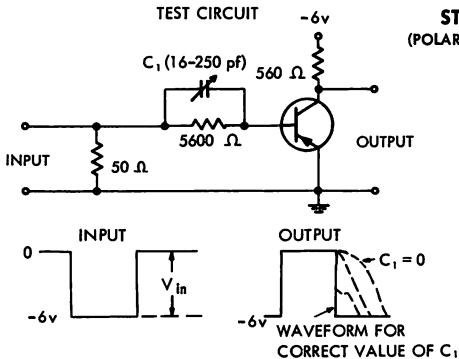

TEST PROCEDURE

The value of capacitor C_1 is increased until the transistor turns off monotonically, as shown. The stored base charge is then calculated from $Q_{sb} = V_{in} C_1$.

NOTES: 1. Input pulse supplied by generator with following characteristics:

- Output impedance: 50 ohms
- Repetition rate: 1 kc
- Rise and fall time: 20 nanoseconds maximum
- Pulse width: 10 microseconds

2. Waveforms monitored on scope with following characteristics:

- Input resistance: 10 megohms minimum
 - Input capacitance: 15 pf maximum
 - Risetime: 15 nanoseconds maximum
3. All resistors $\pm 1\%$ tolerance

N-P-N TYPES 2N1302, 2N1304, 2N1306, AND 2N1308 P-N-P TYPES 2N1303, 2N1305, 2N1307, AND 2N1309 COMPLEMENTARY ALLOY-JUNCTION GERMANIUM TRANSISTORS

TYPICAL CHARACTERISTICS

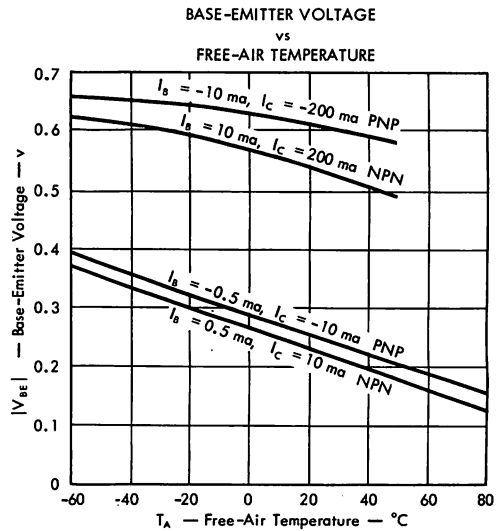
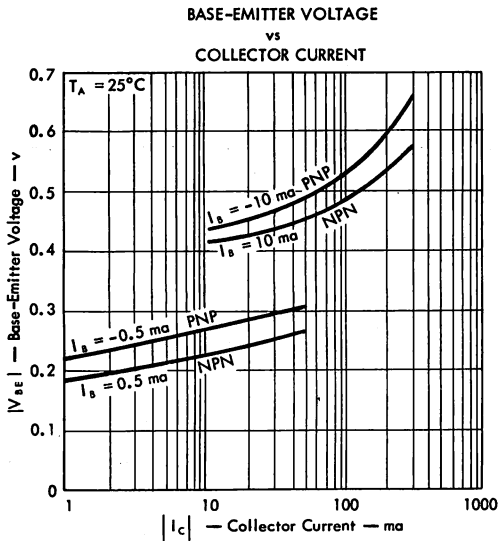
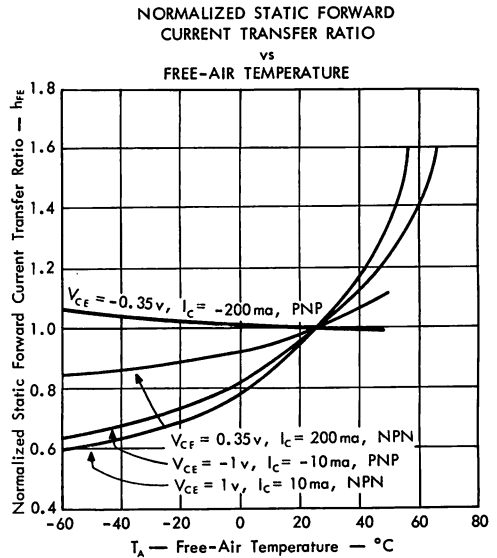
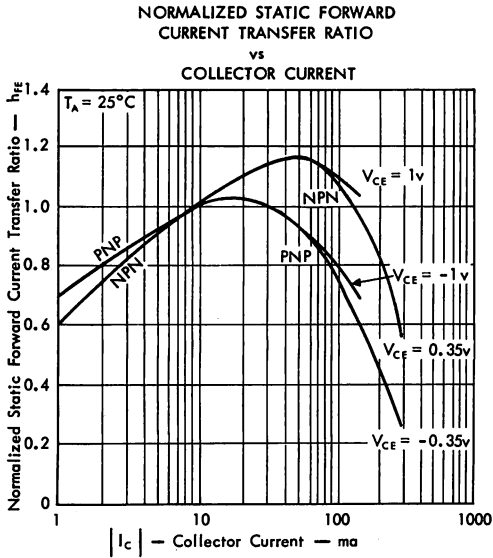

N-P-N TYPES 2N1302, 2N1304, 2N1306, AND 2N1308 P-N-P TYPES 2N1303, 2N1305, 2N1307, AND 2N1309 COMPLEMENTARY ALLOY-JUNCTION GERMANIUM TRANSISTORS

TYPICAL CHARACTERISTICS

COLLECTOR-EMITTER SATURATION VOLTAGE
vs
COLLECTOR CURRENT

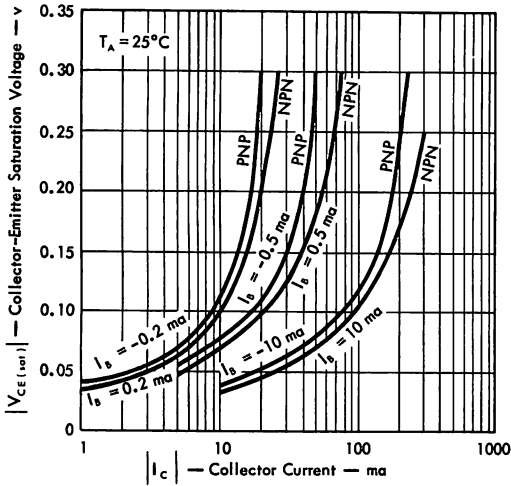

COLLECTOR-EMITTER SATURATION VOLTAGE
vs
FREE-AIR TEMPERATURE

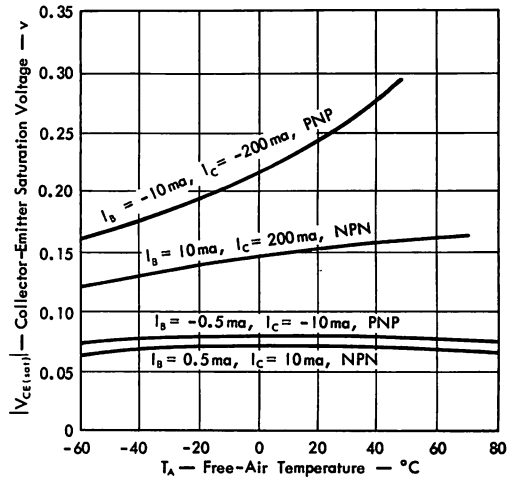

COLLECTOR CUTOFF CURRENT
vs
FREE-AIR TEMPERATURE

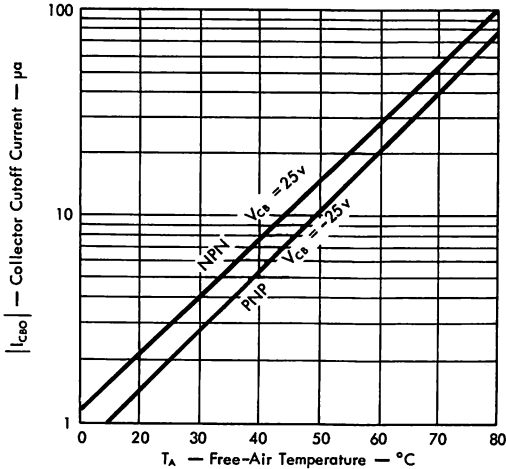

COMMON-BASE OPEN-CIRCUIT OUTPUT CAPACITANCE
vs
COLLECTOR-BASE VOLTAGE

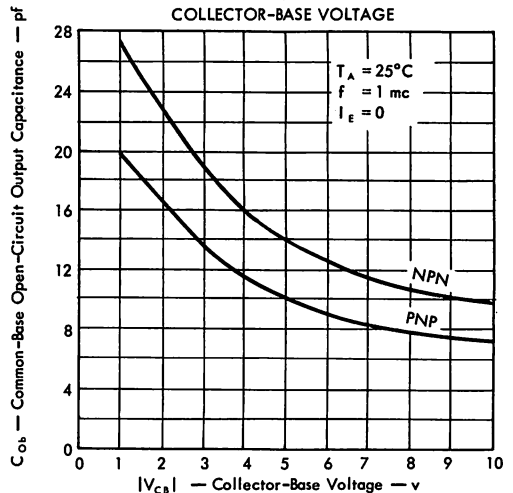

N-P-N TYPES 2N1302, 2N1304, 2N1306, AND 2N1308 P-N-P TYPES 2N1303, 2N1305, 2N1307, AND 2N1309 COMPLEMENTARY ALLOY-JUNCTION GERMANIUM TRANSISTORS

TYPICAL CHARACTERISTICS

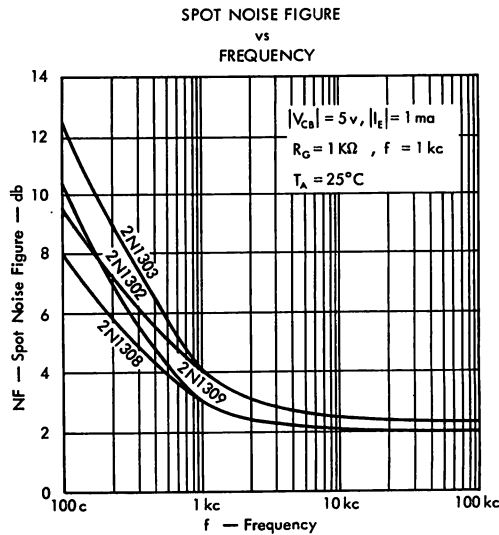
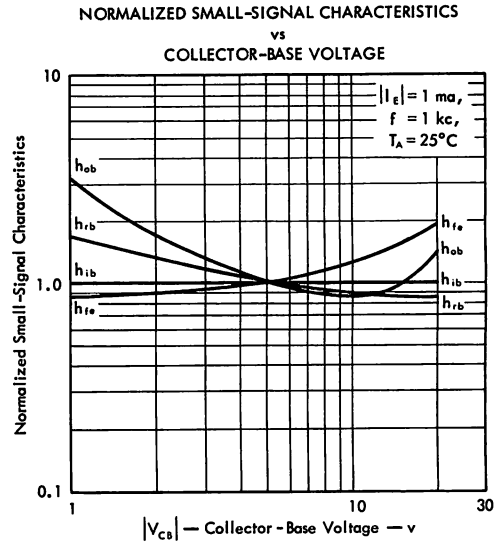
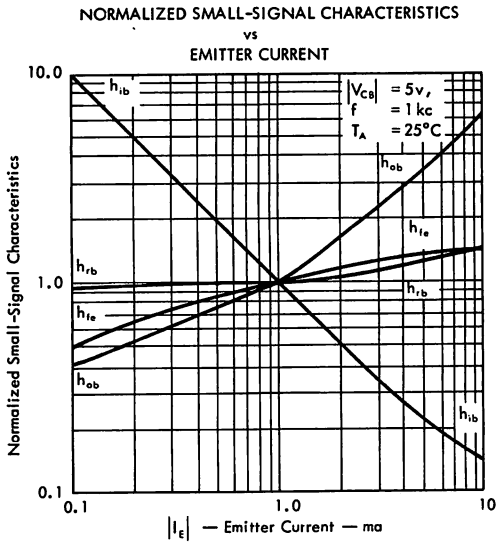



TYPES 2N1372 THRU 2N1381
BULLETIN NO. DL-5 668313, JUNE 1960
REPLACES BULLETIN NO. DL-5 60424, DECEMBER 1960

LINEAR BETA, LOW DISTORTION, HIGH POWER GAIN

Specifically designed for low-frequency
general-purpose industrial applications

- switching
- servo amplifiers
- audio amplifiers
- pagers
- intercoms
- motor controls

environmental tests

To ensure maximum integrity, stability, and long life, finished devices are subjected to the following tests and conditions prior to thorough testing for rigid adherence to specified characteristics.

- Continuous Quality Control checks on in-process assembly are maintained.
- All devices are heat aged at 100°C for 100 hours minimum.
- The hermetic seal is verified for all devices by gross-leak tests.

Production samples are life tested at regularly scheduled periods to ensure maximum reliability under extreme operating conditions.

mechanical data

The transistors are in a JEDEC TO-5* hermetically sealed welded package with glass-to-metal seal between case and leads. Approximate weight is one gram.

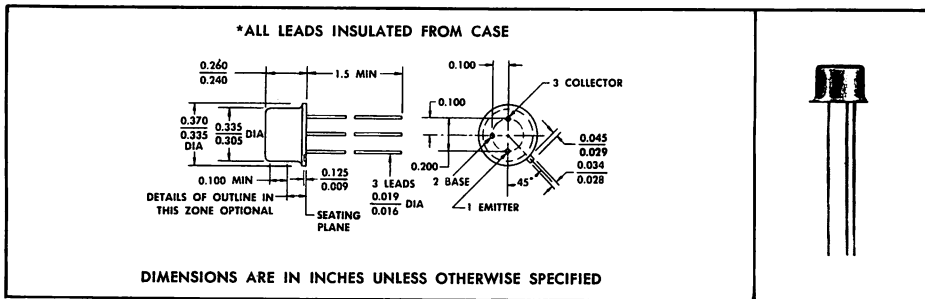

***absolute maximum ratings at 25°C free-air temperature (unless otherwise noted)**

	2N1372	2N1373	2N1378	2N1379
Collector-Base Voltage	-25 V	-45 V	-12 V	-25 V
Collector-Emitter Voltage (See Note 1)	-25 V	-45 V	-12 V	-25 V
Emitter-Base Voltage	-15 V	-25 V	-7 V	-15 V
Continuous Collector Current	← -200 mA →			
Continuous Device Dissipation at (or below) 25°C				
Free-Air Temperature (See Note 2)	← 250 mW →			
Storage Temperature Range	← -55°C to 100°C →			
Lead Temperature 1/8 Inch from Case for 12 Seconds	← 235°C →			

NOTES: 1. This value applies when base-emitter resistance $R_{BE} \leq 2.2 \text{ k}\Omega$.
 2. Derate linearly to 100°C free-air temperature at the rate of 3.33 mW/deg.
 *Indicates JEDEC registered data.

TYPES 2N1372 THRU 2N1381

P-N-P ALLOY-JUNCTION GERMANIUM TRANSISTORS

*electrical characteristics at 25°C free-air temperature

PARAMETER	TEST CONDITIONS	2N1372		2N1373		2N1374		2N1375		2N1376		UNIT
		MIN	MAX	MIN	MAX	MIN	MAX	MIN	MAX	MIN	MAX	
$V_{(BR)CBO}$	Collector-Base Breakdown Voltage $I_C = -100 \mu A, I_E = 0$	-25		-45		-25		-45		-25		V
$V_{(BR)CER}$	Collector-Emitter Breakdown Voltage $I_C = -100 \mu A, R_{BE} = 2.2 k\Omega$	-25		-45		-25		-45		-25		V
$V_{(BR)EBO}$	Emitter-Base Breakdown Voltage $I_E = -100 \mu A, I_C = 0$	-15		-25		-15		-25		-15		V
I_{CBO}	Collector Cutoff Current $V_{CB} = -20 V, I_E = 0$		-7		-7		-7		-7		-7	μA
I_{EBO}	Emitter Cutoff Current $V_{EB} = -4.5 V, I_C = 0$		-15		-15		-15		-15		-15	μA
h_{FE}	Static Forward Current Transfer Ratio $V_{CE} = -1 V, I_C = -50 mA$	27	105	27	105	45	165	45	165	67	165	
V_{BE}	Base-Emitter Voltage $V_{CE} = -1 V, I_C = -100 mA$	-0.2	-0.7	-0.2	-0.7	-0.2	-0.7	-0.2	-0.7	-0.2	-0.7	V
$V_{CE(sat)}$	Collector-Emitter Saturation Voltage $I_B = -5 mA, I_C = -100 mA$		-1		-1							V
							-1		-1			
											-1	
h_{fo}	Small-Signal Common-Emitter Forward Current Transfer Ratio $V_{CE} = -5 V, I_E = 1 mA, f = 1 kHz$	18	127	18	127	36	187	36	187	54	187	

PARAMETER	TEST CONDITIONS	2N1377		2N1378		2N1379		2N1380		2N1381		UNIT
		MIN	MAX	MIN	MAX	MIN	MAX	MIN	MAX	MIN	MAX	
$V_{(BR)CBO}$	Collector-Base Breakdown Voltage $I_C = -100 \mu A, I_E = 0$	-45		-12		-25		-12		-25		V
$V_{(BR)CER}$	Collector-Emitter Breakdown Voltage $I_C = -100 \mu A, R_{BE} = 2.2 k\Omega$	-45		-12		-25		-12		-25		V
$V_{(BR)EBO}$	Emitter-Base Breakdown Voltage $I_E = -100 \mu A, I_C = 0$	-25		-7		-15		-7		-15		V
I_{CBO}	Collector Cutoff Current $V_{CB} = -12 V, I_E = 0$		-7		-7		-7		-14		-14	μA
I_{EBO}	Emitter Cutoff Current $V_{EB} = -4.5 V, I_C = 0$		-15		-15		-15		-15		-15	μA
h_{FE}	Static Forward Current Transfer Ratio $V_{CE} = -1 V, I_C = -50 mA$	67	165	85	330	85	330	27	330	27	330	
V_{BE}	Base-Emitter Voltage $V_{CE} = -1 V, I_C = -100 mA$	-0.2	-0.7	-0.2	-0.7	-0.2	-0.7	-0.2	-0.7	-0.2	-0.7	V
$V_{CE(sat)}$	Collector-Emitter Saturation Voltage $I_B = -5 mA, I_C = -100 mA$		-1						-1		-1	V
					-1		-1					
h_{fo}	Small-Signal Common-Emitter Forward Current Transfer Ratio $V_{CE} = -5 V, I_E = 1 mA, f = 1 kHz$	54	187	67	385	67	385	18	385	18	385	

*Indicates JEDEC registered data.

TYPES 2N1372 THRU 2N1381 P-N-P ALLOY-JUNCTION GERMANIUM TRANSISTORS

TYPICAL CHARACTERISTICS

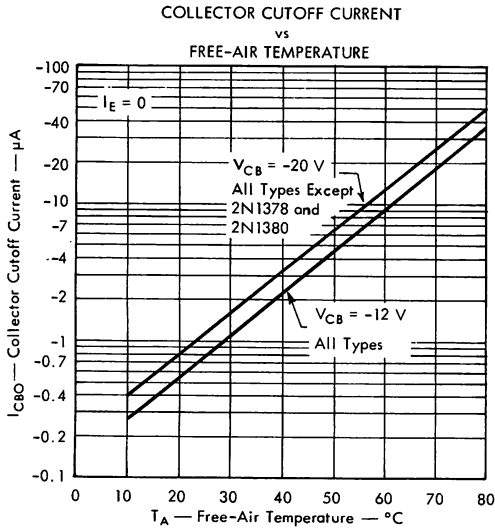

FIGURE 1

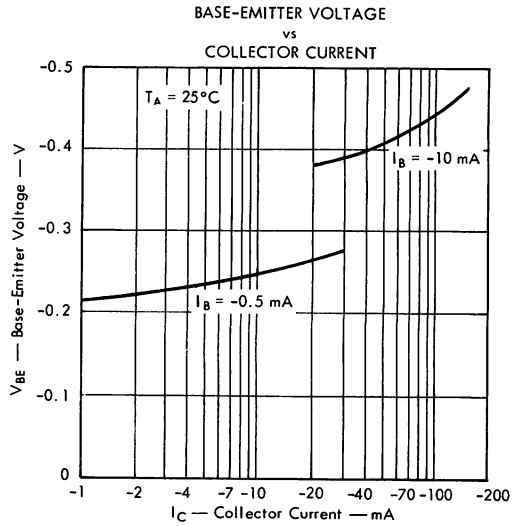

FIGURE 2

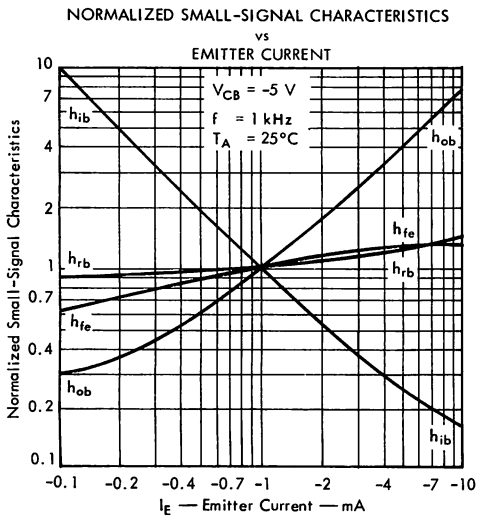

FIGURE 3

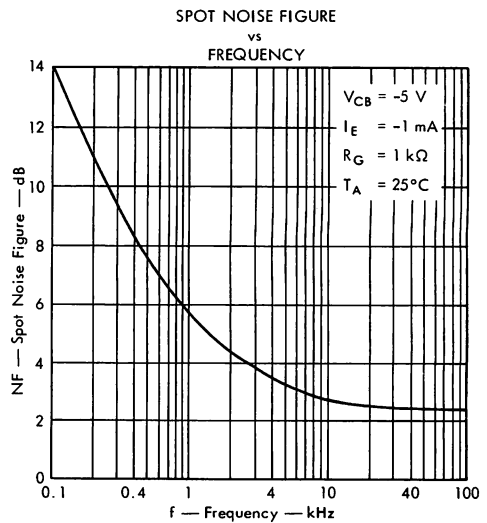

FIGURE 4

TYPES 2N1372 THRU 2N1381

P-N-P ALLOY-JUNCTION GERMANIUM TRANSISTORS

TYPICAL CHARACTERISTICS

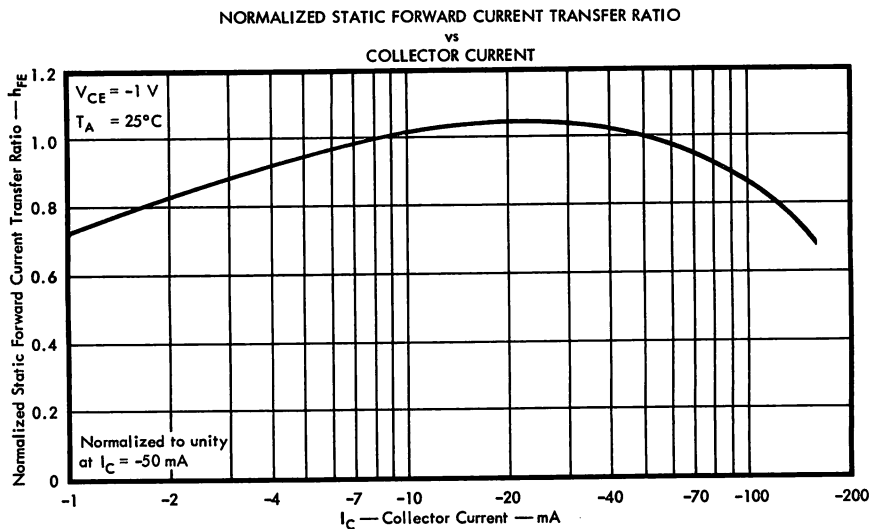

FIGURE 5

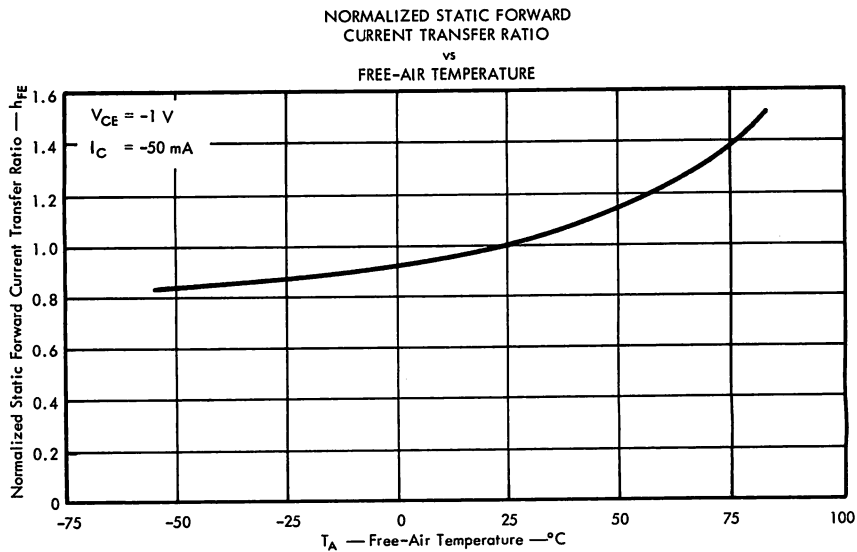

FIGURE 6

TYPES 2N1997, 2N1998, and 2N1999 P-N-P ALLOY-JUNCTION GERMANIUM TRANSISTORS



TYPES 2N1997, 2N1998, AND 2N1999
BULLETIN NO. D.L.S. 611879, AUGUST 1961

For Medium-Power Switching and General Purpose Applications

- High Current Gain
- High Cutoff Frequency
- Guaranteed Switching Times
- Leads Isolated From Case

environmental tests

To ensure maximum reliability, stability, and long life, all units are aged at 100°C for 100 hours minimum prior to electrical characterization. All transistors are thoroughly tested for complete adherence to specified design characteristics. In addition, continuous qualification tests are made comprising temperature-humidity cycling, shock, and vacuum leak testing under rigid in-process control procedures.

mechanical data

Metal case with glass-to-metal hermetic seal between case and leads. Unit weight is approximately one gram. These units meet JEDEC outline TO-5.

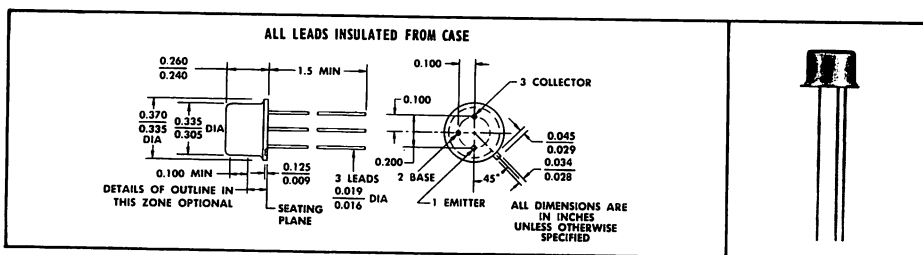

absolute maximum ratings at 25°C ambient temperature (unless otherwise noted)

	2N1997	2N1998	2N1999
Collector-Base Voltage	45 v	35 v	30 v
Collector-Emitter Voltage (see note 1)	40 v	35 v	20 v
Emitter-Base Voltage	45 v	30 v	20 v
Collector Current	500 ma	500 ma	500 ma
Base Current	50 ma	50 ma	50 ma
Total Device Dissipation (see note 2)	250 mw	250 mw	250 mw
Total Device Dissipation at 25°C Case (see note 3)	500 mw	500 mw	500 mw
Collector Junction Temperature	100°C	100°C	100°C
Storage Temperature Range	-65°C to +100°C	-65°C to +100°C	-65°C to +100°C

- NOTES: 1. $V_{BE} = 0.3$ v
 2. Derate 3.3 mw/°C above ambient temperature of 25°C.
 3. Derate 6.6 mw/°C above case temperature of 25°C.

TYPES 2N1997, 2N1998, and 2N1999

P-N-P ALLOY-JUNCTION GERMANIUM TRANSISTORS

electrical characteristics at 25°C ambient temperature

parameter	test conditions	2N1997			2N1998			2N1999			unit
		min	typ	max	min	typ	max	min	typ	max	
I_{CBO} Collector reverse current	$V_{CB} = -1.5 \text{ v}, I_E = 0$		-1.5	-5		-1.5	-5		-1.5	-5	μa
I_{CBO} Collector reverse current	$V_{CB} = -15 \text{ v}, I_E = 0$		-2.5	-6		-2.5	-6		-2.5	-6	μa
BV_{CBO} Collector-base breakdown voltage	$I_C = -25 \mu\text{a}, I_E = 0$	-45			-35			-30			v
BV_{CEX} Collector-emitter breakdown voltage	$I_C = -100 \mu\text{a}, V_{BE} = 0.3 \text{ v}$	-40			-35			-20			v
BV_{EBO} Emitter-base breakdown voltage	$I_E = -50 \mu\text{a}, I_C = 0$	-45			-30			-20			v
h_{FE} DC forward current transfer ratio	$V_{CE} = -1 \text{ v}, I_C = -100 \text{ ma}$	40	70	200	70	95	225	100	150	350	
h_{FE} DC forward current transfer ratio	$V_{CE} = -1 \text{ v}, I_C = -200 \text{ ma}$				50	70	160	75	120	250	
V_{BE} Base-emitter voltage	$I_B = -0.33 \text{ ma}, I_C = -10 \text{ ma}$		-0.26	-0.34	-0.15	-0.25	-0.34	-0.15	-0.24	-0.34	v
V_{BE} Base-emitter voltage	$I_B = -6.6 \text{ ma}, I_C = -200 \text{ ma}$				-0.30	-0.56	-0.65	-0.30	-0.52	-0.65	v
$V_{CE(sat)}$ Collector-emitter saturation voltage	$I_B = -0.33 \text{ ma}, I_C = -10 \text{ ma}$		-0.10	-0.20		-0.07	-0.20		-0.06	-0.20	v
$V_{CE(sat)}$ Collector-emitter saturation voltage	$I_B = -6.6 \text{ ma}, I_C = -200 \text{ ma}$					-0.23	-0.35		-0.20	-0.35	v
$ h_{fe} $ AC common-emitter forward current transfer ratio	$V_{CE} = -5 \text{ v}, I_E = 3 \text{ ma}, f = 4 \text{ mc}$				1.4	2.0		2.5	4.0		
C_{ob} Common-base output capacitance	$V_{CB} = -5 \text{ v}, I_E = 0, f = 1 \text{ mc}$		10	20		10	20		10	20	pf
f_{hfb} Common-base alpha cutoff frequency	$V_{CB} = -5 \text{ v}, I_E = 3 \text{ ma}$		3	6		10			17		mc

switching characteristics at 25°C ambient temperature

parameter	test conditions	2N1997			2N1998			2N1999			unit
		min	typ	max	min	typ	max	min	type	max	
t_d Delay time	See Circuit A		0.040	0.060		0.040	0.060		0.030	0.060	μsec
t_r Rise time	See Circuit A		0.250	0.300		0.180	0.240		0.110	0.175	μsec
t_s Storage time	See Circuit B		0.440	0.750		0.430	0.750		0.390	0.750	μsec
t_f Fall time	See Circuit B		0.200	0.400		0.150	0.330		0.090	0.185	μsec
t_T Total switching time			0.930			0.800			0.620		μsec

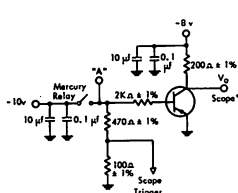

Circuit A

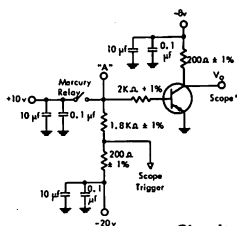
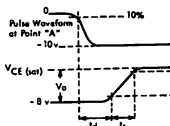

Circuit B

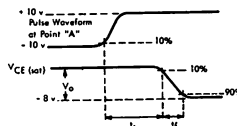

*Tektronix 541 scope with type CA plug-in, or equivalent. Maximum probe capacitance 15 pf.

TYPES 2N1997, 2N1998, and 2N1999 P-N-P ALLOY-JUNCTION GERMANIUM TRANSISTORS

TYPICAL COMMON-EMITTER COLLECTOR CHARACTERISTICS

MEASURED ON TEKTRONIX 575 CURVE TRACER, $T_A = 25^\circ\text{C}$

2N1997

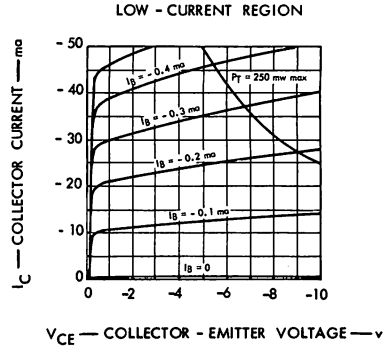
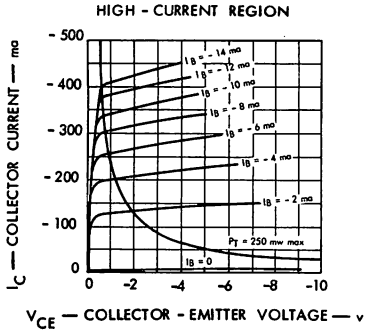

2N1998

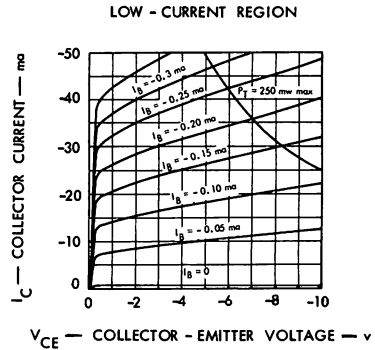
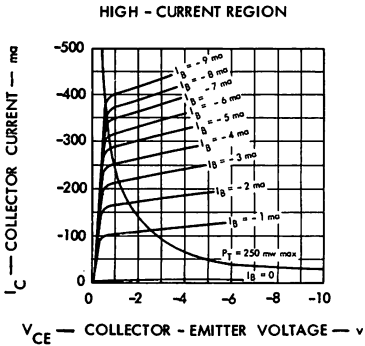

2N1999

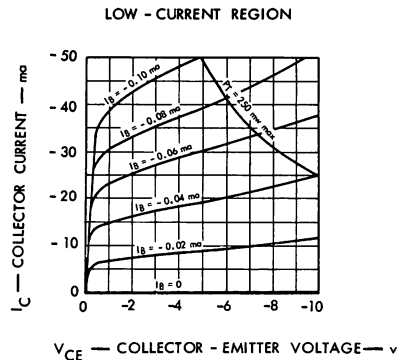
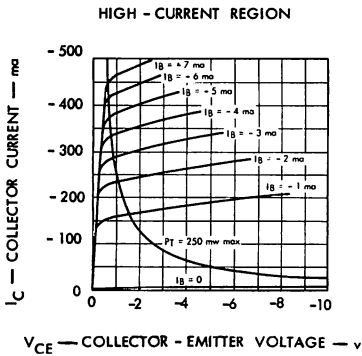

TYPES 2N1997, 2N1998, and 2N1999

P-N-P ALLOY-JUNCTION GERMANIUM TRANSISTORS

TYPICAL COMMON-EMITTER COLLECTOR CHARACTERISTICS

MEASURED ON TEKTRONIX 575 CURVE TRACER, $T_A = -25^\circ\text{C}$

2N1997

HIGH - CURRENT SATURATION REGION

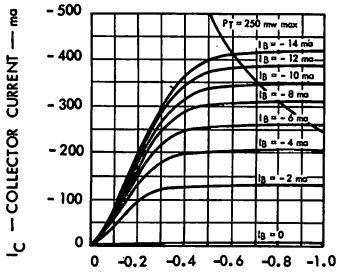

V_{CE} — COLLECTOR - EMITTER VOLTAGE — v

LOW - CURRENT SATURATION REGION

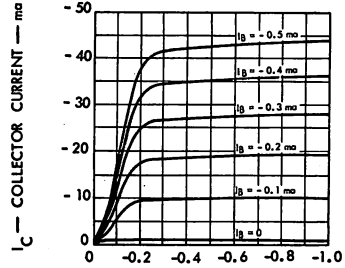

V_{CE} — COLLECTOR - EMITTER VOLTAGE — v

2N1998

HIGH - CURRENT SATURATION REGION

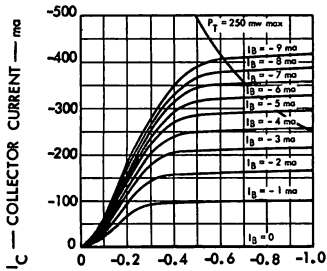

V_{CE} — COLLECTOR - EMITTER VOLTAGE — v

LOW - CURRENT SATURATION REGION

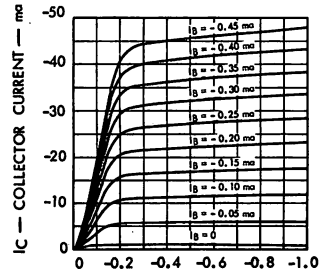

V_{CE} — COLLECTOR - EMITTER VOLTAGE — v

2N1999

HIGH - CURRENT SATURATION REGION

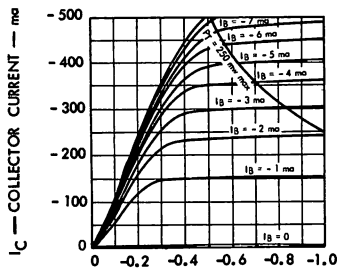

V_{CE} — COLLECTOR - EMITTER VOLTAGE — v

LOW - CURRENT SATURATION REGION

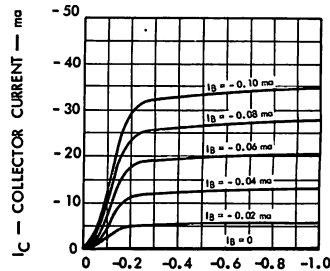

V_{CE} — COLLECTOR - EMITTER VOLTAGE — v

TYPES 2N1997, 2N1998, and 2N1999 P-N-P ALLOY-JUNCTION GERMANIUM TRANSISTORS

TYPICAL CHARACTERISTICS

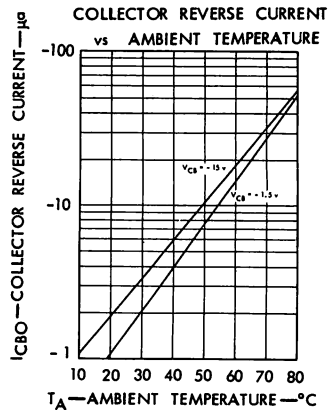
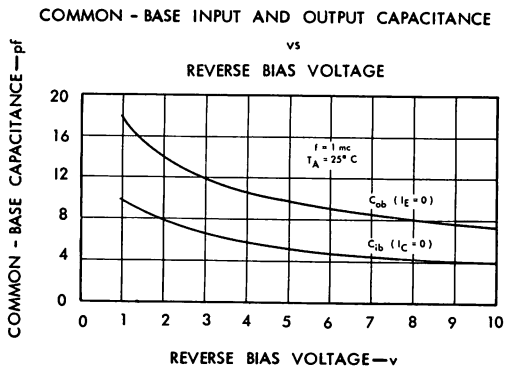
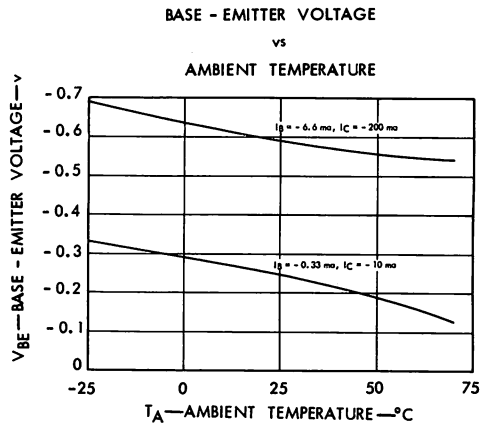
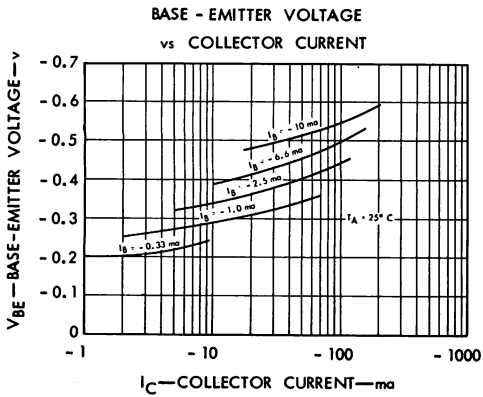
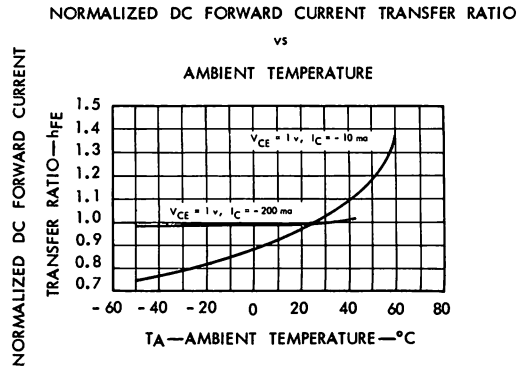
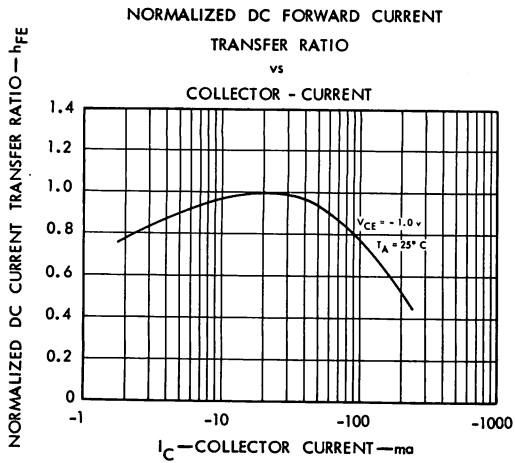

TYPES 2N1997, 2N1998, and 2N1999

P-N-P ALLOY-JUNCTION GERMANIUM TRANSISTORS

TYPICAL CHARACTERISTICS

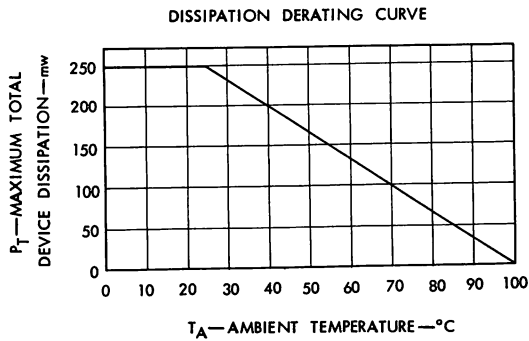
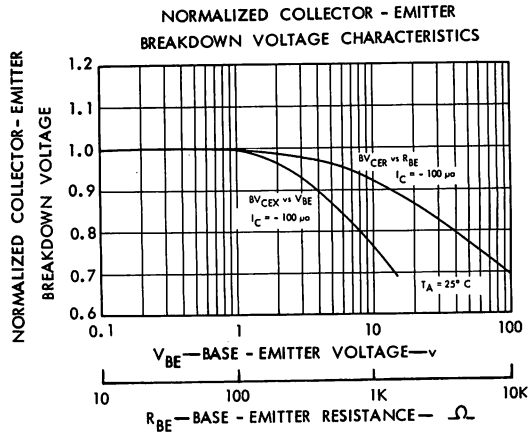
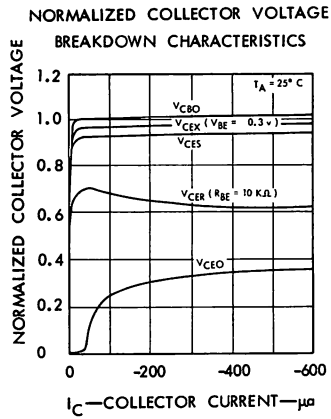

TYPES 2N2000 and 2N2001 P-N-P ALLOY-JUNCTION GERMANIUM TRANSISTORS



TYPES 2N2000 AND 2N2001
 BULLETIN NO. D1-5 651872, AUGUST 1961
 REVISED OCTOBER 1965

High-Frequency Transistors for Computer and Switching Applications

- High Beta
- 1 Amp Collector Current
- Guaranteed Switching Times

environmental tests

To ensure maximum reliability, stability, and long life, all units are aged at 100°C for 100 hours minimum prior to electrical characterization. In addition, the hermetic seal is checked by a helium leak test to detect 50×10^{-8} standard cubic centimeters/second of helium. All transistors are thoroughly tested for complete adherence to specified electrical characteristics.

mechanical data

Metal case with glass-to-metal hermetic seal between case and leads. Unit weight is approximately 1 gram. These units meet JEDEC outline TO-5.

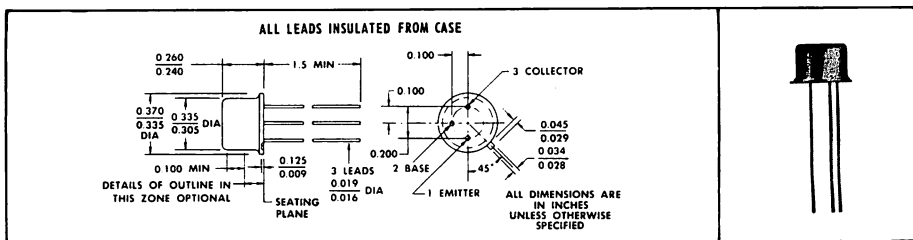

absolute maximum ratings at 25°C ambient temperature (unless otherwise noted)

	2N2000	2N2001	unit
Collector-Base Voltage	50	30	v
Emitter-Base Voltage	20	20	v
Collector Current	1	1	amp
Total Device Dissipation (see note)	300	300	mw
Collector Junction Temperature	100°C		
Storage Temperature Range	-65°C to 100°C		

NOTE: Derate 4.0 mw/°C above ambient temperature of 25°C. This is equivalent to a maximum power rating of 600 mw at a case temperature of 25°C.

TYPES 2N2000 and 2N2001

P-N-P ALLOY-JUNCTION GERMANIUM TRANSISTORS

electrical characteristics at 25°C ambient temperature (unless otherwise noted)

parameter	test conditions	2N2000		2N2001		unit
		min	max	min	max	
I_{CBO} Collector reverse current	$V_{CB} = -30\text{ v}, I_E = 0$ $V_{CB} = -15\text{ v}, I_E = 0$	-10		-6		μa μa
BV_{CBO} Collector-base breakdown voltage	$I_C = -100\ \mu\text{a}, I_E = 0$	-50		-30		v
BV_{CEX} Collector-emitter breakdown voltage	$I_C = -100\ \mu\text{a}, V_{BE} = 0.5\text{ v}$	-50		-30		v
BV_{EBO} Emitter-base breakdown voltage	$I_E = -100\ \mu\text{a}, I_C = 0$	-20		-20		v
h_{FE} DC forward current transfer ratio	$V_{CE} = -0.3\text{ v}, I_C = -100\text{ ma}$	50	300	100		
h_{FE} DC forward current transfer ratio	$V_{CE} = -0.5\text{ v}, I_C = -500\text{ ma}$	50	300	60		
V_{BE} Base-emitter voltage	$I_B = -2\text{ ma}, I_C = -100\text{ ma}$ $I_B = -20\text{ ma}, I_C = -500\text{ ma}$	-0.2	-0.4	-0.2	-0.4	v
$V_{CE(sat)}$ Collector-emitter saturation voltage	$I_B = -2\text{ ma}, I_C = -100\text{ ma}$ $I_B = -20\text{ ma}, I_C = -500\text{ ma}$	-0.25	-0.35	-0.20	-0.35	v
C_{ob} Common-base output capacitance	$V_{CB} = -10\text{ v}, I_E = 0, f = 1\text{ mc}$	35		35		pf
$f_{\alpha fb}$ Common-base alpha cutoff frequency	$V_{CB} = -5\text{ v}, I_E = 3\text{ ma}$	2		6		mc

switching characteristics (measured in switching test circuit shown below at 25°C ambient temp.)

parameter	2N2000		2N2001		unit
	min	max	min	max	
t_d Delay time		0.12		0.10	μsec
t_r Rise time		0.70		0.60	μsec
t_s Storage time		0.65		0.65	μsec
t_f Fall time		0.75		0.65	μsec

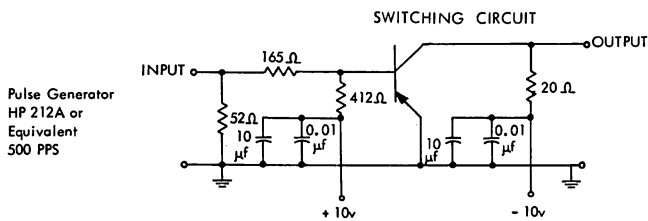

541 Tektronix
Oscilloscope and CA Plug-In Unit.
Equivalent, Probe
Capacitance 15 pf
Maximum

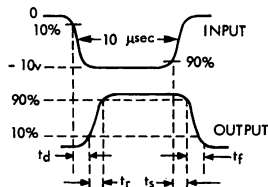

TYPES 2N2000 and 2N2001 P-N-P ALLOY-JUNCTION GERMANIUM TRANSISTORS

TYPICAL COMMON-EMITTER COLLECTOR CHARACTERISTICS AT 25°C

AMBIENT TEMPERATURE AS MEASURED ON TEKTRONIX 575 CURVE TRACER

2N2000

HIGH - CURRENT REGION

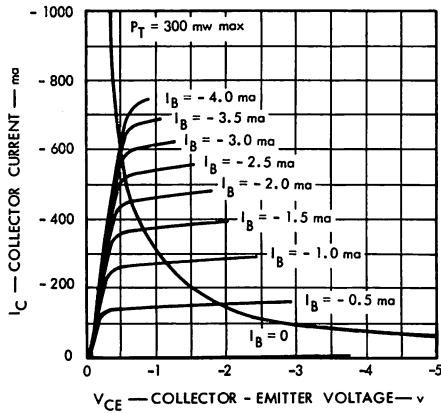

LOW - CURRENT REGION

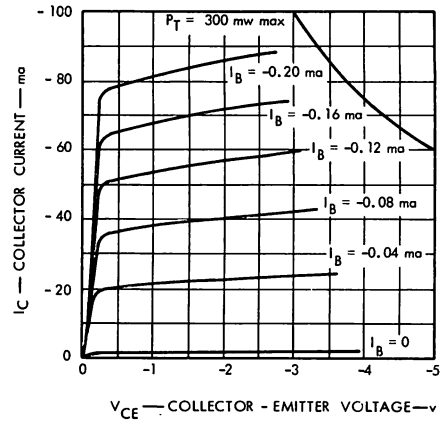

2N2001

HIGH - CURRENT REGION

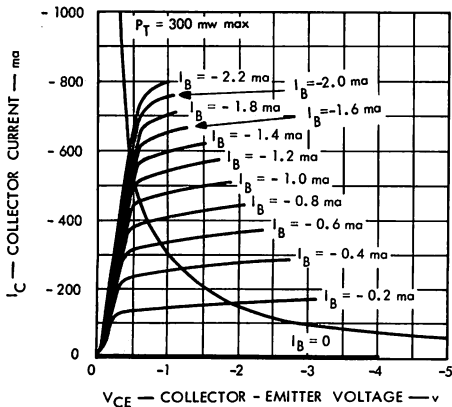

LOW - CURRENT REGION

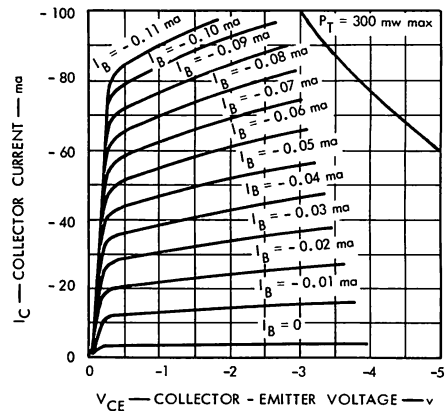

TYPES 2N2000 and 2N2001

P-N-P ALLOY-JUNCTION GERMANIUM TRANSISTORS

TYPICAL COMMON-EMITTER COLLECTOR CHARACTERISTICS AT 25°C
 AMBIENT TEMPERATURE AS MEASURED ON TEKTRONIX 575 CURVE TRACER

2N2000

HIGH - CURRENT SATURATION REGION

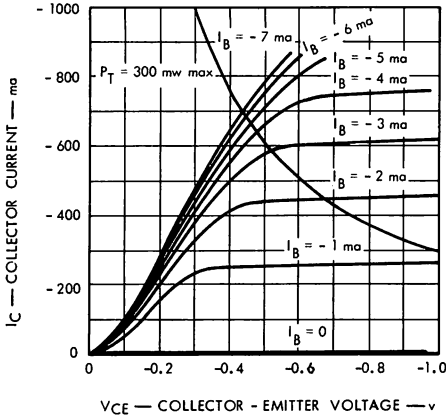

LOW - CURRENT SATURATION REGION

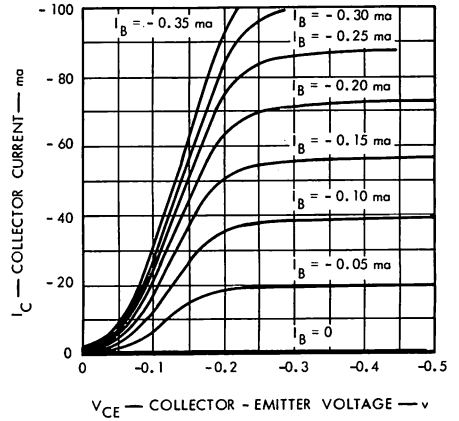

2N2001

HIGH - CURRENT SATURATION REGION

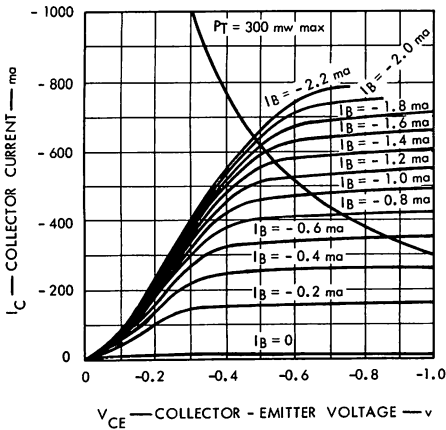

LOW - CURRENT SATURATION REGION

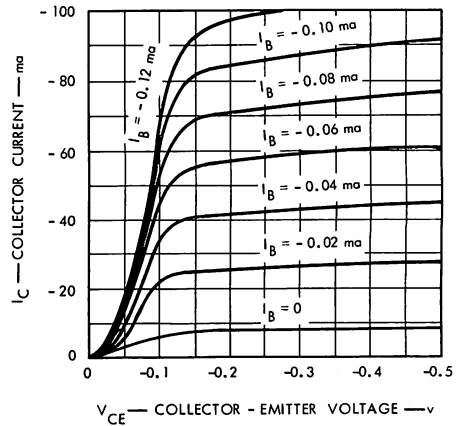

TYPES 2N2000 and 2N2001

P-N-P ALLOY-JUNCTION GERMANIUM TRANSISTORS

TYPICAL CHARACTERISTICS

NORMALIZED DC FORWARD CURRENT TRANSFER RATIO

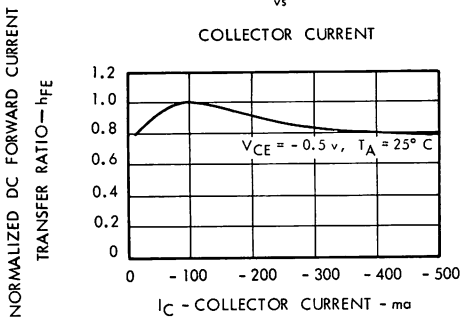

NORMALIZED DC FORWARD CURRENT TRANSFER RATIO

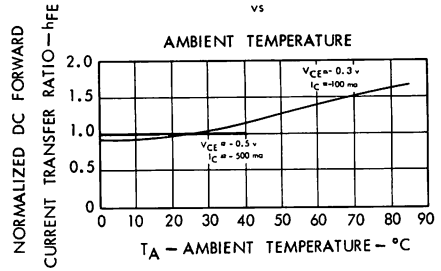

BASE-EMITTER VOLTAGE

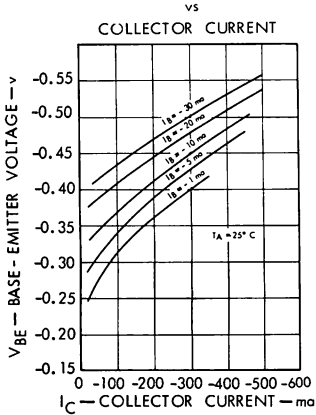

BASE-EMITTER VOLTAGE

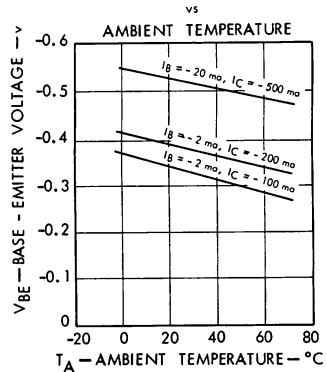

COMMON-BASE INPUT AND OUTPUT CAPACITANCE

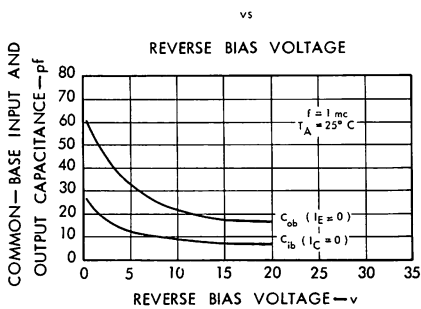

COLLECTOR REVERSE CURRENT

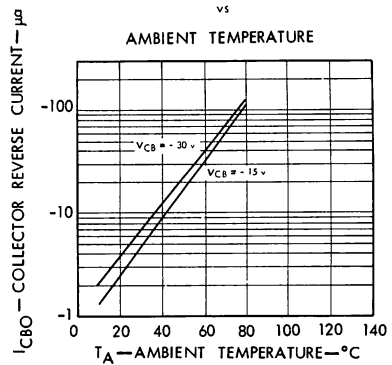

TYPES 2N2000 and 2N2001

P-N-P ALLOY-JUNCTION GERMANIUM TRANSISTORS

TYPICAL CHARACTERISTICS

NORMALIZED COLLECTOR VOLTAGE CHARACTERISTICS

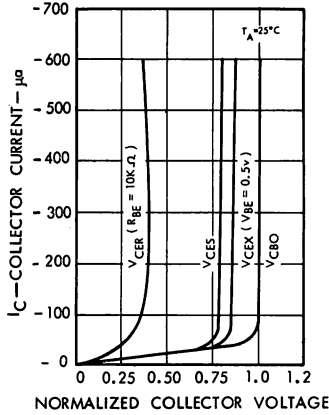

NORMALIZED COLLECTOR - EMITTER BREAKDOWN VOLTAGE CHARACTERISTICS

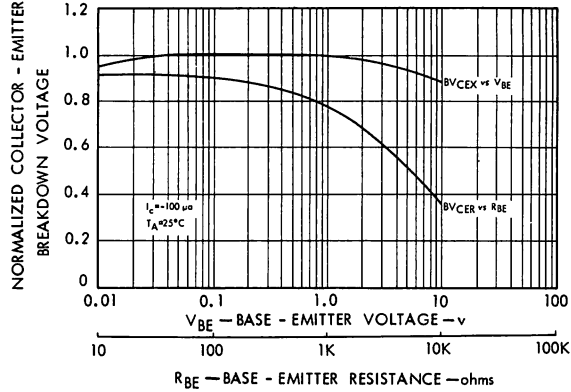

DISSIPATION DERATING CURVE

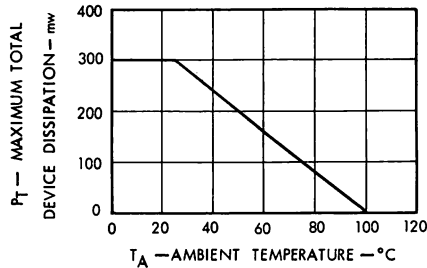

TYPE 2N797 N-P-N DIFFUSED-BASE MESA GERMANIUM TRANSISTOR



TYPE 2N797
BULLETIN NO. DL-5 612267, FEBRUARY 1962
REVISED OCTOBER 1966

VERY-HIGH-SPEED SWITCHING TRANSISTOR

Guaranteed Total Switching Time —120 nsec Maximum at 10 ma

Guaranteed $V_{CE(sat)}$ —0.14 v Maximum at 10 ma

Guaranteed $V_{CE(sat)}$ —0.35 v Maximum at 50 ma

Guaranteed f_T —600 mc Minimum

Complementary to Ultra-High-Speed P-N-P Germanium Switching Transistors

*mechanical data

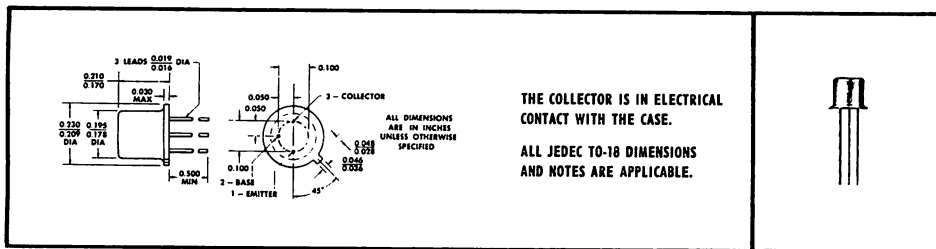

*absolute maximum ratings at 25°C free-air temperature (unless otherwise noted)

Collector-Base Voltage	20 v
Collector-Emitter Voltage (See note 1)	7 v
Emitter-Base Voltage	4 v
Collector Current	150 ma
Total Device Dissipation at 25°C Free-Air Temperature (See note 2)	150 mw
Collector Junction Operating Temperature	100°C
Storage Temperature Range	-65°C to +100°C

electrical characteristics at 25°C free-air temperature

parameter	test conditions	*min	typ	*max	unit
I_{CBO} Collector Cutoff Current	$V_{CB} = 10$ v, $I_E = 0$		0.1	1.0	μ a
I_{EBO} Emitter Cutoff Current	$V_{EB} = 1$ v, $I_C = 0$		0.1	1.0	μ a
I_{EBO} Emitter Cutoff Current	$V_{EB} = 4$ v, $I_C = 0$			100	μ a
BV_{CBO} Collector-Base Breakdown Voltage	$I_C = 100$ μ a, $I_E = 0$	20			v
BV_{CEO} Collector-Emitter Breakdown Voltage	$I_C = 5$ ma, $I_B = 0$	7.0			v
h_{FE} DC Forward Current Transfer Ratio	$V_{CE} = 0.25$ v, $I_C = 10$ ma	40	75		
h_{FE} DC Forward Current Transfer Ratio	$V_{CE} = 0.5$ v, $I_C = 50$ ma	40	85		
V_{BE} Base-Emitter Voltage	$I_B = 0.5$ ma, $I_C = 10$ ma	0.30	0.38	0.44	v
V_{BE} Base-Emitter Voltage	$I_B = 2.5$ ma, $I_C = 50$ ma	0.40	0.58	0.72	v
$V_{CE(sat)}$ Collector-Emitter Saturation Voltage	$I_B = 0.5$ ma, $I_C = 10$ ma		0.10	0.14	v
$V_{CE(sat)}$ Collector-Emitter Saturation Voltage	$I_B = 2.5$ ma, $I_C = 50$ ma		0.26	0.35	v
$ h_{fe} $ AC Common-Emitter Forward Current Transfer Ratio	$V_{CE} = 5$ v, $f = 100$ mc, $I_C = 30$ ma	6.0	10		
C_{cb} Collector-Base Capacitance †	$V_{CB} = 5$ v, $f = 1$ mc, $I_E = 0$		3.0	4.0	pf

NOTES: 1. This value applies when the emitter-base diode is open-circuited. This value can be exceeded in applications where the dc circuit resistance (R_{dc}) between base and emitter is a finite value.

* Indicates JEDEC registered data.

2. Derate linearly to 100°C free-air temperature at the rate of 2 mw/°C.

† Collector-Base Capacitance is measured using three-terminal measurement techniques with the emitter guarded.

The device is capable of 300mw dissipation at 25°C case temperature. Derate linearly to 100°C case temperature at the rate of 4 mw/°C.



TEXAS INSTRUMENTS
INCORPORATED
POST OFFICE BOX 5012 • DALLAS, TEXAS 75222

12101

TYPE 2N797

N-P-N DIFFUSED-BASE MESA GERMANIUM TRANSISTOR

switching characteristics at 25°C free-air temperature

parameter	*test conditions	approximate circuit conditions	typ	*max	unit
t_{on} Turn-on Time	See Figure 1	$V_{BE(0)} = -1.25$ v, $I_{B(1)} = 1$ ma, $I_C = 10$ ma (See note 3)	27	40	nsec
t_{off} Turn-off Time		$I_{B(1)} = 1$ ma, $I_{B(2)} = -0.33$ ma, $I_C = 10$ ma (See note 3)	60	80	nsec

SWITCHING CIRCUIT

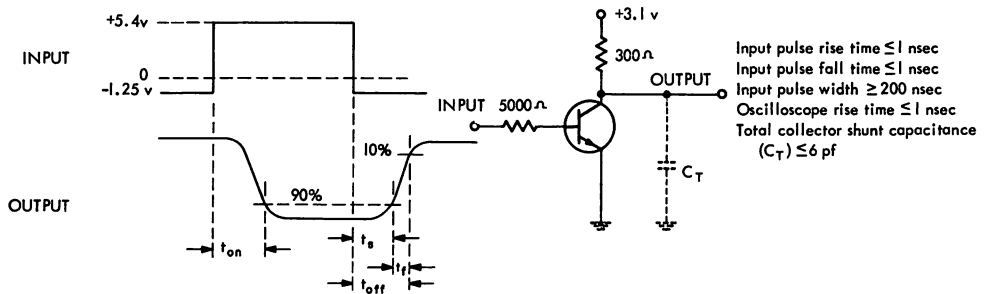
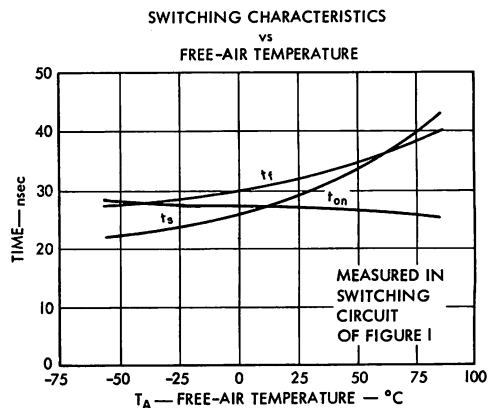
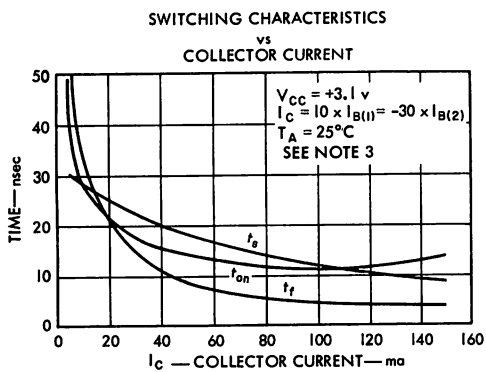

FIGURE 1

For accurate measurement of switching speed of this transistor, a mercury relay input pulse and sampling scope are required. Oscilloscope input resistance is approximately 100K; the input capacitance is approximately 3 pf.

TYPICAL CHARACTERISTICS



NOTE 3: Current calculations ($I_{B(1)}$, $I_{B(2)}$, and I_C) include the typical values of V_{BE} or $V_{CE(sat)}$ for appropriate values of collector current.
*Indicates JEDEC registered data.

TYPE 2N797

N-P-N DIFFUSED-BASE MESA GERMANIUM TRANSISTOR

TYPICAL CHARACTERISTICS

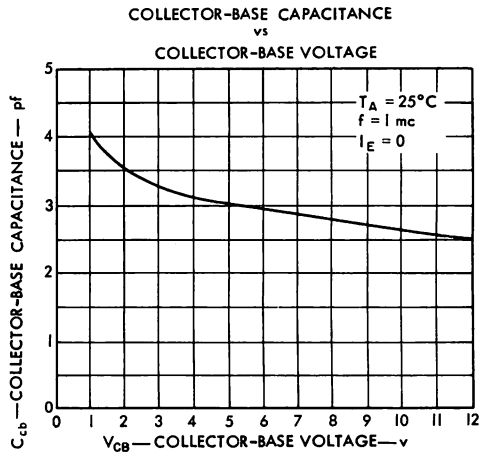
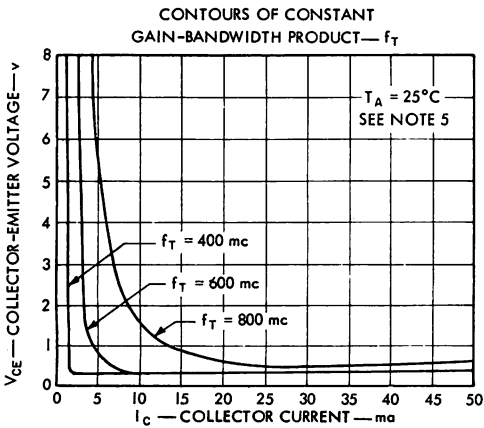
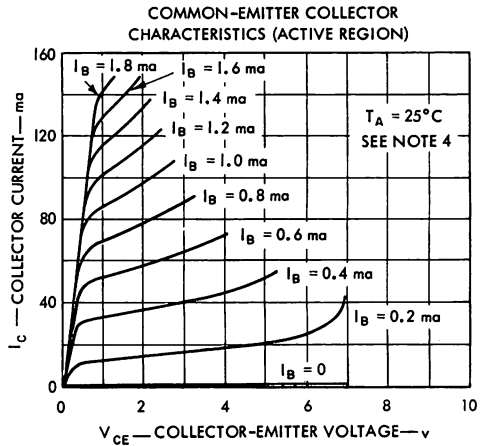
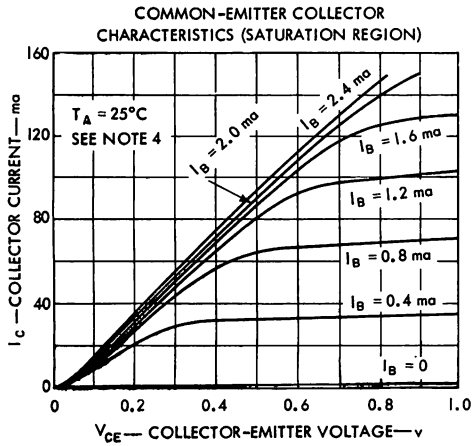

NOTES: 4. These parameters were measured using pulse techniques. $PW = 300 \mu\text{sec}$, duty cycle $\leq 2\%$.

5. To obtain f_T , the $|h_{re}|$ response with frequency is extrapolated at -6 db/octave from $f = 100$ mc to the frequency at which $|h_{re}| = 1$.

TYPE 2N797 N-P-N DIFFUSED-BASE MESA GERMANIUM TRANSISTOR

TYPICAL CHARACTERISTICS

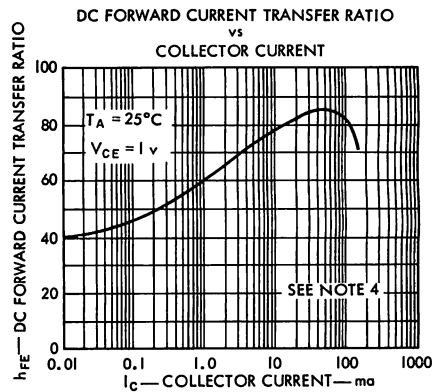
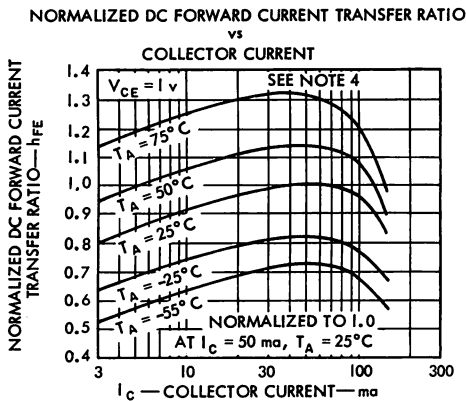
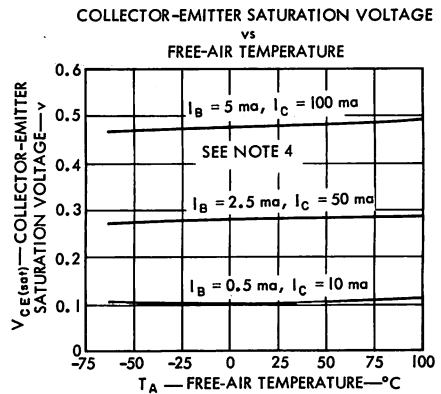
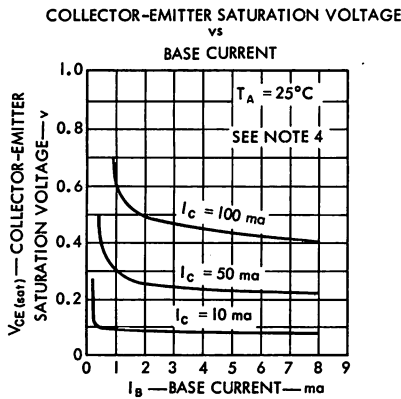
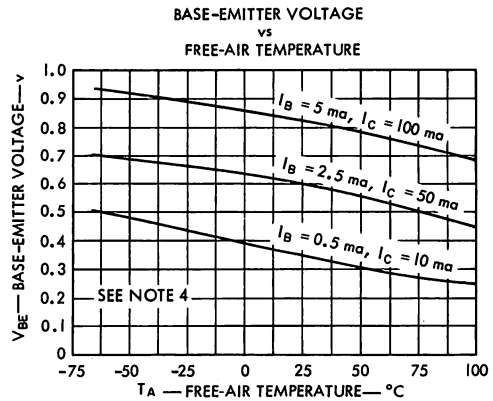
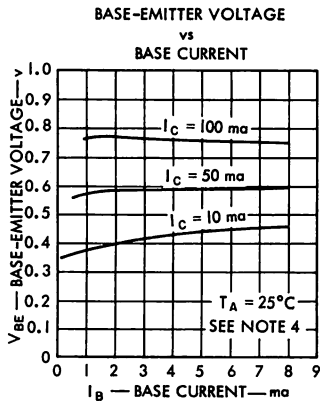

TYPES 2N960, 2N961, 2N962, 2N964, 2N965, 2N966 P-N-P EPITAXIAL DIFFUSED-BASE MESA GERMANIUM TRANSISTORS



TYPES 2N960, 2N961, 2N962, 2N964, 2N965, 2N966
BULLETIN NO. DL-5 682628, MAY 1962

FOR ULTRA-HIGH-SPEED SWITCHING APPLICATIONS

- Epitaxial Process
- Rugged Mesa Construction
- Low $V_{CE(sat)}$ — Guaranteed at 10 ma, 50 ma, and 100 ma
Typically 0.11 v at 10 ma
- Ultra-Fast-Switching Time — Guaranteed at 10 ma and 100 ma
- High f_T — Guaranteed Minimum of 300 mc, Typically 500 mc

*mechanical data

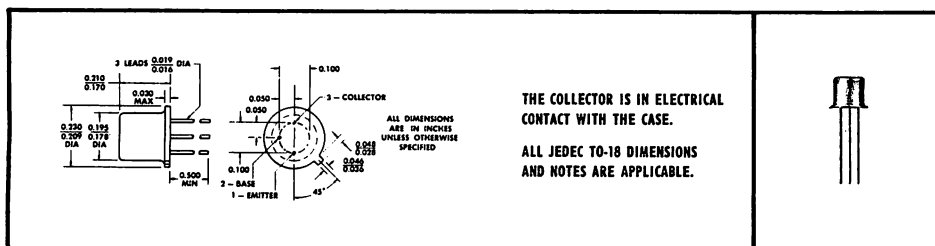

*absolute maximum ratings at 25°C free-air temperature (unless otherwise noted)

	2N960	2N961	2N962
	2N964	2N965	2N966
Collector-Base Voltage	15 v	12 v	12 v
Collector-Emitter Voltage (See Note 1)	15 v	12 v	12 v
Collector-Emitter Voltage (See Note 2)	7 v	7 v	7 v
Emitter-Base Voltage	2.5 v	2.0 v	1.25 v
Collector Current	← 100 ma →		
Total Device Dissipation at (or below) 25°C Free-Air Temperature (See Note 3)	← 150 mw →		
Total Device Dissipation at (or below) 25°C Case Temperature (See Note 4)	← 300 mw →		
Operating Collector Junction Temperature	← 100°C →		
Storage Temperature Range	-65°C to +100°C		

quick-selection guide (for details see characteristics on pages 2 and 3)

TYPE	MINIMUM BV_{CBO}		MINIMUM h_{FE}		MAXIMUM t_{off}	
	15 v	12 v	40	20	60 nsec	75 nsec
2N960	•			•	•	
2N961		•		•	•	
2N962		•		•		•
2N964	•		•		•	
2N965		•	•		•	
2N966		•	•			•

- NOTES: 1. This value applies when the emitter-base diode is short-circuited.
 2. This value applies when the emitter-base diode is open-circuited.
 3. Derate linearly to 100°C free-air temperature at the rate of 2 mw/°C.
 4. Derate linearly to 100°C case temperature at the rate of 4 mw/°C.

*Indicates JEDEC registered data.

TYPES 2N960, 2N961, 2N962, 2N964, 2N965, 2N966

P-N-P EPITAXIAL DIFFUSED-BASE MESA GERMANIUM TRANSISTORS

electrical characteristics at 25°C free-air temperature

PARAMETER	TEST CONDITIONS	2N960			2N961			2N962			UNIT
		MIN	TYP	MAX	MIN	TYP	MAX	MIN	TYP	MAX	
BV_{CBO} Collector-Base Breakdown Voltage	$I_C = -100 \mu A, I_E = 0$	-15*			-12*			-12*			v
BV_{EBO} Emitter-Base Breakdown Voltage	$I_E = -100 \mu A, I_C = 0$	-2.5*			-2.0*			-1.25*			v
$V_{CEX(L)}$ Collector-Emitter Latching Voltage	$V_{CC} = -11.5 v, R_L = 220 \Omega$ (See Figure 1, Page 3)	-11.5			-11.5			-11.5			v
I_{CBO} Collector Cutoff Current	$V_{CB} = -6 v, I_E = 0$			-3.0*				-3.0*		-3.0*	μA
I_{CES} Collector Cutoff Current	$V_{CE} = -15 v, V_{BE} = 0$			-100*							μA
	$V_{CE} = -12 v, V_{BE} = 0$							-100*		-100*	μA
I_{EBO} Emitter Cutoff Current	$V_{EB} = -2.5 v, I_C = 0$			-100*							μA
	$V_{EB} = -2.0 v, I_C = 0$							-100*			μA
	$V_{EB} = -1.25 v, I_C = 0$								-100*		μA
h_{FE} Static Forward Current Transfer Ratio	$V_{CE} = -0.3 v, I_C = -10 ma$	20*			20*			20*			
	$V_{CE} = -1 v, I_C = -50 ma$	20*			20*			20*			
	$V_{CE} = -1 v, I_C = -100 ma$	20*			20*			20*			
V_{BE} Base-Emitter Voltage	$I_B = -1 ma, I_C = -10 ma$	-0.30*	-0.40	-0.50*	-0.30*	-0.40	-0.50*	-0.30*	-0.40	-0.50*	v
	$I_B = -5 ma, I_C = -50 ma$	-0.40*	-0.51	-0.75*	-0.40*	-0.51	-0.75*	-0.40*	-0.51	-0.75*	v
	$I_B = -10 ma, I_C = -100 ma$	-0.40*	-0.60	-1.00*	-0.40*	-0.60	-1.00*	-0.40*	-0.60	-1.25*	v
$V_{CE(sat)}$ Collector-Emitter Saturation Voltage	$I_B = -1 ma, I_C = -10 ma$		-0.12	-0.20*		-0.12	-0.20*		-0.12	-0.20*	v
	$I_B = -5 ma, I_C = -50 ma$		-0.17	-0.40*		-0.17	-0.40*		-0.17	-0.40*	v
	$I_B = -10 ma, I_C = -100 ma$		-0.27	-0.70*		-0.27	-0.70*		-0.27	-0.70*	v
$ h_{fe} $ Small-Signal Common-Emitter Forward Current Transfer Ratio	$V_{CB} = -1 v, I_E = 20 ma$ $f = 100 mc$ (See Note 5)	3.0*	5.0		3.0*	5.0		3.0*	5.0		
C_{ob} Common-Base Open-Circuit Output Capacitance	$V_{CB} = -10 v, I_E = 0$ $f = 1 mc$		3.0	4.0*		3.0	4.0*		3.0	4.0*	pf
C_{ib} Common-Base Open-Circuit Input Capacitance	$V_{EB} = -1 v, I_C = 0$ $f = 100 kc$		2.0	3.5*		2.0	3.5*		2.0	3.5*	pf

electrical characteristics at 25°C free-air temperature

PARAMETER	TEST CONDITIONS	2N964			2N965			2N966			UNIT
		MIN	TYP	MAX	MIN	TYP	MAX	MIN	TYP	MAX	
BV_{CBO} Collector-Base Breakdown Voltage	$I_C = -100 \mu A, I_E = 0$	-15*			-12*			-12*			v
BV_{EBO} Emitter-Base Breakdown Voltage	$I_E = -100 \mu A, I_C = 0$	-2.5*			-2.0*			-1.25*			v
$V_{CEX(L)}$ Collector-Emitter Latching Voltage	$V_{CC} = -11.5 v, R_L = 220 \Omega$ (See Figure 1, Page 3)	-11.5			-11.5			-11.5			v
I_{CBO} Collector Cutoff Current	$V_{CB} = -6 v, I_E = 0$			-3.0*				-3.0*		-3.0*	μA
I_{CES} Collector Cutoff Current	$V_{CE} = -15 v, V_{BE} = 0$			-100*							μA
	$V_{CE} = -12 v, V_{BE} = 0$							-100*		-100*	μA
I_{EBO} Emitter Cutoff Current	$V_{EB} = -2.5 v, I_C = 0$			-100*							μA
	$V_{EB} = -2.0 v, I_C = 0$							-100*			μA
	$V_{EB} = -1.25 v, I_C = 0$								-100*		μA
h_{FE} Static Forward Current Transfer Ratio	$V_{CE} = -0.3 v, I_C = -10 ma$	40*			40*			40*			
	$V_{CE} = -1 v, I_C = -50 ma$	40*			40*			40*			
	$V_{CE} = -1 v, I_C = -100 ma$	40*			40*			40*			
V_{BE} Base-Emitter Voltage	$I_B = -1 ma, I_C = -10 ma$	-0.30*	-0.40	-0.50*	-0.30*	-0.40	-0.50*	-0.30*	-0.40	-0.50*	v
	$I_B = -5 ma, I_C = -50 ma$	-0.40*	-0.51	-0.75*	-0.40*	-0.51	-0.75*	-0.40*	-0.51	-0.75*	v
	$I_B = -10 ma, I_C = -100 ma$	-0.40*	-0.60	-1.00*	-0.40*	-0.60	-1.00*	-0.40*	-0.60	-1.25*	v
$V_{CE(sat)}$ Collector-Emitter Saturation Voltage	$I_B = -1 ma, I_C = -10 ma$		-0.11	-0.18*		-0.11	-0.18*		-0.11	-0.18*	v
	$I_B = -5 ma, I_C = -50 ma$		-0.16	-0.35*		-0.16	-0.35*		-0.16	-0.35*	v
	$I_B = -10 ma, I_C = -100 ma$		-0.26	-0.60*		-0.26	-0.60*		-0.26	-0.60*	v
$ h_{fe} $ Small-Signal Common-Emitter Forward Current Transfer Ratio	$V_{CB} = -1 v, I_E = 20 ma$ $f = 100 mc$ (See Note 5)	3.0*	5.0		3.0*	5.0		3.0*	5.0		
C_{ob} Common-Base Open-Circuit Output Capacitance	$V_{CB} = -10 v, I_E = 0$ $f = 1 mc$		3.0	4.0*		3.0	4.0*		3.0	4.0*	pf
C_{ib} Common-Base Open-Circuit Input Capacitance	$V_{EB} = -1 v, I_C = 0$ $f = 100 kc$		2.0	3.5*		2.0	3.5*		2.0	3.5*	pf

NOTE 5: This is equivalent to $f_T = 300 mc$ minimum. To obtain f_T , the $|h_{fe}|$ response with frequency is extrapolated at the rate of -6 db/octave from $f = 100 mc$ to the frequency at which $|h_{fe}| = 1$.

* Indicates JEDEC registered data.

TYPES 2N960, 2N961, 2N962, 2N964, 2N965, 2N966

P-N-P EPITAXIAL DIFFUSED-BASE MESA GERMANIUM TRANSISTORS

switching characteristics at 25°C free-air temperature

PARAMETER	TEST CONDITIONS†		2N960 2N961 2N964 2N965		2N962 2N966		UNIT
			TYP	MAX	TYP	MAX	
			t_{on} Turn-On Time	$I_C = -10$ ma, $V_{BE(off)} = +1.25$ v, $I_C = -100$ ma, $V_{BE(off)} = +1.25$ v,	$I_{B(1)} = -1$ ma, $R_L = 300 \Omega$ $I_{B(1)} = -5$ ma, $R_L = 50 \Omega$	See Figure 3 See Figure 4 See Figure 5 See Figure 6	
t_{off} Turn-Off Time	$I_C = -10$ ma, $I_{B(2)} = +0.25$ ma, $I_C = -100$ ma, $I_{B(2)} = +1.25$ ma,	$I_{B(1)} = -1$ ma, $R_L = 300 \Omega$ $I_{B(1)} = -5$ ma, $R_L = 50 \Omega$	See Figure 3 See Figure 4 See Figure 5 See Figure 6	48 85* 40 85*	60 60 42 100*	55 75 100* 75	nsec
Q_T Total Control Charge	$I_C = -10$ ma, $I_C = -100$ ma,	$I_{B(1)} = -1$ ma, $I_{B(1)} = -5$ ma	See Figure 7 See Figure 8	80* 125*	90* 150*	90* 150*	pcb

†Voltage and current values shown are nominal; exact values vary slightly with transistor parameters.

PARAMETER MEASUREMENT INFORMATION

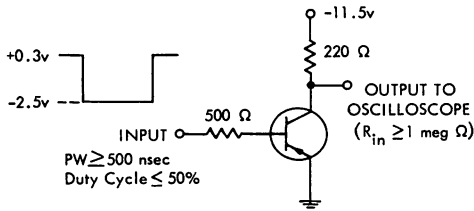

FIGURE 1 — COLLECTOR-EMITTER LATCHING VOLTAGE TEST CIRCUIT

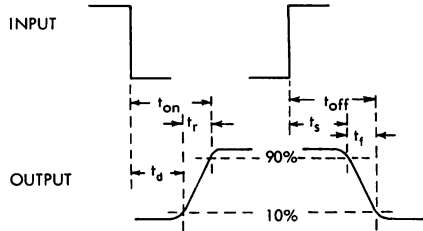

FIGURE 2 — VOLTAGE WAVEFORM DETAILS FOR 10 ma AND 100 ma (I_C) SWITCHING CIRCUITS

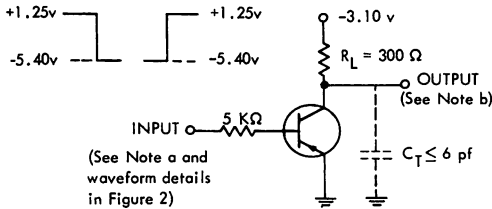

FIGURE 3 — 10 ma (I_C) SWITCHING CIRCUIT

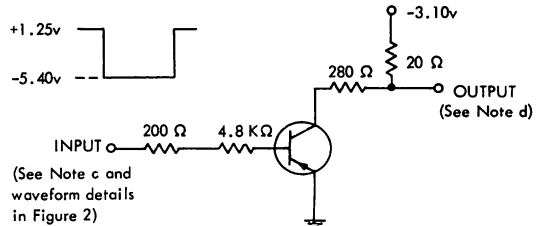

FIGURE 4 — 10 ma (I_C) SWITCHING CIRCUIT

NOTES: a. The input waveforms in Figures 3 and 5 have the following characteristics: $t_r \leq 1$ nsec, $t_f \leq 1$ nsec, $PW \geq 200$ nsec.

b. Waveforms in Figures 3 and 5 are monitored on an oscilloscope with the following characteristics: $t_r \leq 1$ nsec, $R_{in} \geq 100$ K Ω , $C_{in} \leq 3$ pf. The input impedance of the oscilloscope is included in the values shown for R_L , Total Collector Load Resistance, and C_T , Total Collector Shunt Capacitance.

c. The input waveforms in Figures 4 and 6 are supplied by a generator with the following characteristics: $t_r \leq 2$ nsec, $t_f \leq 2$ nsec, $Z_{out} = 50 \Omega$

d. Waveforms in Figures 4 and 6 are monitored on an oscilloscope with the following characteristics: $t_r \leq 10$ nsec, $R_{in} \geq 1$ meg Ω , $C_{in} \leq 20$ pf.

e. All resistors $\pm 1\%$ tolerance.

*Indicates JEDEC registered data.

TYPES 2N960, 2N961, 2N962, 2N964, 2N965, 2N966

P-N-P EPITAXIAL DIFFUSED-BASE MESA GERMANIUM TRANSISTORS

PARAMETER MEASUREMENT INFORMATION

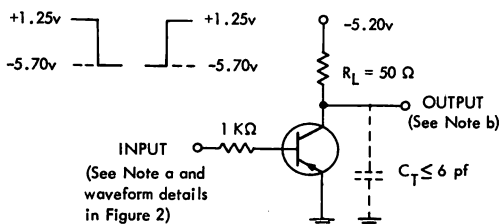

FIGURE 5 — 100 ma (I_C) SWITCHING CIRCUIT

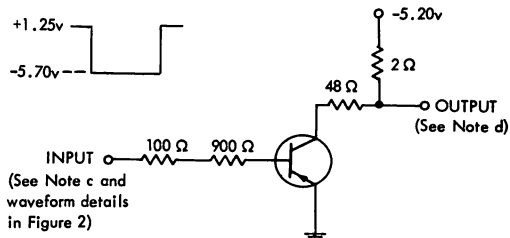

FIGURE 6 — 100 ma (I_C) SWITCHING CIRCUIT

$C = 16$ pf for 2N960, 2N961, 2N964, 2N965
 $C = 18$ pf for 2N962, 2N966

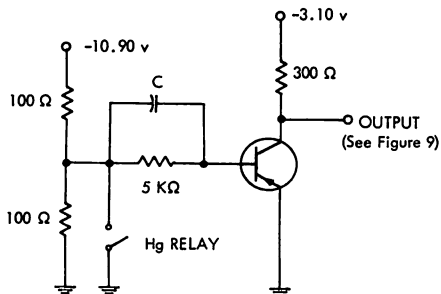

FIGURE 7 — 10 ma (I_C) TOTAL CONTROL CHARGE TEST CIRCUIT

$C = 25$ pf for 2N960, 2N961, 2N964, 2N965
 $C = 30$ pf for 2N962, 2N966

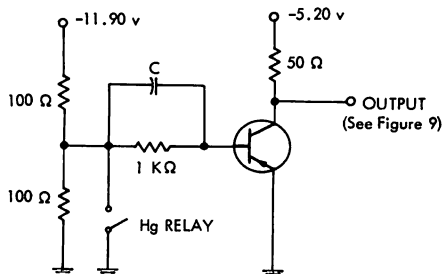
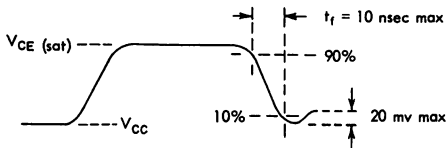

FIGURE 8 — 100 ma (I_C) TOTAL CONTROL CHARGE TEST CIRCUIT



The output waveform is viewed on an oscilloscope with the following characteristics:
 $t_r \leq 3.5$ nsec, $R_{in} \geq 100K\Omega$, $C_{in} \leq 10$ pf

FIGURE 9 — OUTPUT VOLTAGE WAVEFORM DETAILS FOR TOTAL CONTROL CHARGE CIRCUITS

•Indicates JEDEC registered data.

TYPE 2N2635 P-N-P EPITAXIAL DIFFUSED-BASE MESA GERMANIUM TRANSISTOR



TYPE 2N2635
BULLETIN NO. DL-5-633341, JANUARY 1963

FOR HIGH-VOLTAGE, HIGH-SPEED SWITCHING APPLICATIONS

- EPITAXIAL PROCESS
- RUGGED MESA CONSTRUCTION
- V_{CB0} — GUARANTEED 30 v
- HIGH SPEED — GUARANTEED t_T OF 300 nsec

*mechanical data

THE COLLECTOR IS IN ELECTRICAL CONTACT WITH THE CASE.

ALL JEDEC TO-18 dimensions and notes are applicable.

ALL DIMENSIONS ARE IN INCHES UNLESS OTHERWISE SPECIFIED.

absolute maximum ratings at 25°C free-air temperature (unless otherwise noted)

* Collector-Base Voltage	30 v
* Collector-Emitter Voltage (See Note 1)	15 v
* Emitter-Base Voltage	2.5 v
* Collector Current	100 ma
* Total Device Dissipation at (or below) 25°C Free-Air Temperature (See Note 2)	150 mw
Total Device Dissipation at (or below) 25°C Case Temperature (See Note 3).	300 mw
* Storage Temperature Range	-65°C to +100°C

electrical characteristics at 25°C free-air temperature (unless otherwise noted)

PARAMETER	TEST CONDITIONS	*MIN	*MAX	UNIT
V_{CB0} Collector-Base Breakdown Voltage	$I_C = -100 \mu a, I_E = 0$	-30		v
V_{CEO} Collector-Emitter Breakdown Voltage	$I_C = -2 ma, I_B = 0$	-15		v
V_{EBO} Emitter-Base Breakdown Voltage	$I_E = -100 \mu a, I_C = 0$	-2.5		v
I_{CB0} Collector Cutoff Current	$V_{CB} = -25 v, I_E = 0$		-5	μa
	$V_{CB} = -25 v, I_E = 0, T_A = +55^\circ C$		-20	μa
I_{EBO} Emitter Cutoff Current	$V_{EB} = -1 v, I_C = 0$		-20	μa
	$V_{CE} = -0.5 v, I_C = -10 ma$	30		
h_{FE} Static Forward Current Transfer Ratio	$V_{CE} = -1 v, I_C = -50 ma$	45	300	
	$V_{CE} = -1 v, I_C = -50 ma, T_A = -55^\circ C$	25		
	$V_{CE} = -1 v, I_C = -100 ma$	30		
V_{BE} Base-Emitter Voltage	$I_B = -0.5 ma, I_C = -10 ma$		-0.45	v
	$I_B = -2.5 ma, I_C = -50 ma$		-0.70	v
	$I_B = -2.5 ma, I_C = -50 ma, T_A = -55^\circ C$		-0.85	v
	$I_B = -10 ma, I_C = -100 ma$		-0.90	v
$V_{CE(sat)}$ Collector-Emitter Saturation Voltage	$I_B = -0.5 ma, I_C = -10 ma$		-0.20	v
	$I_B = -2.5 ma, I_C = -50 ma$		-0.40	v
	$I_B = -2.5 ma, I_C = -50 ma, T_A = +55^\circ C$		-0.45	v
	$I_B = -10 ma, I_C = -100 ma$		-0.75	v
$ h_{fe} $ Small-Signal Common-Emitter Forward Current Transfer Ratio	$V_{CE} = -2 v, I_C = -30 ma, f = 100 mc$	1.5		
C_{ob} Common-Base Open-Circuit Output Capacitance	$V_{CB} = -5 v, I_E = 0, f = 1 mc$		5.0	pf
C_{ib} Common-Base Open-Circuit Input Capacitance	$V_{EB} = -1 v, I_C = 0, f = 1 mc$		4.0	pf

*Indicates JEDEC registered data.

- NOTES: 1. This value applies when the emitter-base diode is open-circuited.
 2. Derate linearly to 100°C free-air temperature at the rate of 2 mw/°C.
 3. Derate linearly to 100°C case temperature at the rate of 4 mw/°C.



TEXAS INSTRUMENTS
INCORPORATED
POST OFFICE BOX 5012 • DALLAS, TEXAS 75222

TYPE 2N2635

P-N-P EPITAXIAL DIFFUSED-BASE MESA GERMANIUM TRANSISTOR

switching characteristics at 25°C free-air temperature

PARAMETER	TEST CONDITIONS †	MIN	TYP	*MAX	UNIT
t_d Delay Time	$I_C = -11 \text{ ma}$, $I_{B(1)} = -1 \text{ ma}$			20	nsec
t_r Rise Time	$I_{B(2)} = +0.25 \text{ ma}$			30	nsec
t_s Storage Time	$V_{BE(off)} = 1.25 \text{ v}$, $R_L = 300 \Omega$			185	nsec
t_f Fall Time	(See Figure 1)			65	nsec
t_{on} Turn-on Time	$I_C = -40 \text{ ma}$, $I_{B(1)} = -2.5 \text{ ma}$ $V_{BE(off)} = 1.8 \text{ v}$ (See Figure 2)		25		nsec
t_{off} Turn-off Time	$I_C = -14 \text{ ma}$, $I_{B(1)} = -2.5 \text{ ma}$ $I_{B(2)} = 1.5 \text{ ma}$ (See Figure 3)		80		nsec

† Voltage and current values shown are nominal; exact values vary slightly with device parameters.

PARAMETER MEASUREMENT INFORMATION

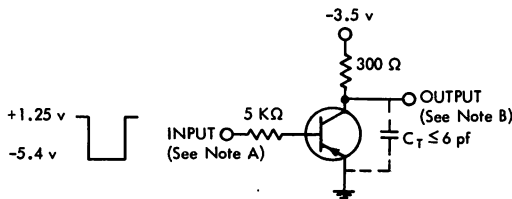

* FIGURE 1 SWITCHING CIRCUIT

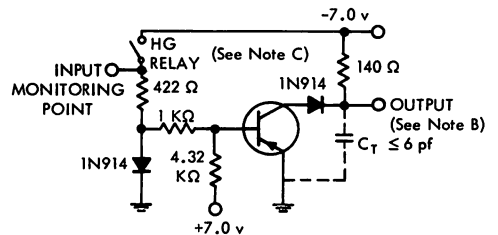

FIGURE 2 TDL NAND TURN-ON SWITCHING CIRCUIT SIMULATED FOR $M = N = 3$

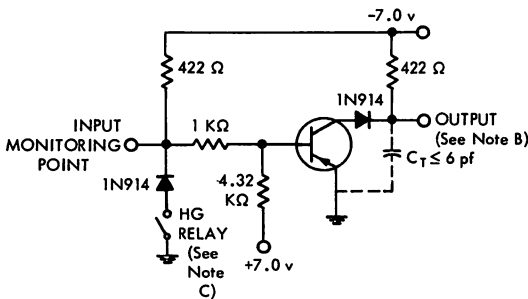

FIGURE 3 TDL NAND TURN-OFF SWITCHING CIRCUIT SIMULATED FOR $M = N = 3$

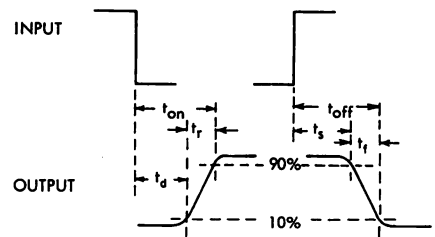

FIGURE 4 VOLTAGE WAVEFORM DETAILS FOR SWITCHING MEASUREMENTS

NOTES: A. The input waveform of Figure 1 has following characteristics: t_r and $t_f \leq 1 \text{ nsec}$; $PW \geq 0.5 \mu\text{sec}$; Duty cycle $\leq 50\%$.

B. Waveforms are monitored on equipment with following characteristics: $t_r \leq 3.5 \text{ nsec}$; $R_{in} \geq 100k \Omega$; $C_{in} \leq 3\text{pf}$; C_T , total output shunt capacitance, includes C_{in} .

C. Operating frequency is 60 cps.

*Indicates JEDEC registered data.

TYPES 2N5043, 2N5044 P-N-P EPITAXIAL PLANAR GERMANIUM TRANSISTORS



TYPES 2N5043, 2N5044
BULLETIN NO. DLS-679705, MARCH 1967

**FOR APPLICATIONS REQUIRING LOW NOISE FIGURE AND SUPERIOR
SMALL-SIGNAL PERFORMANCE FROM VHF TO 1 GIGAHERTZ
(Improved Versions of TIXM101)**

2N5043 Features

- **Guaranteed Noise Figure ... 2.5 dB Max at 400 MHz**
- **Guaranteed f_T ... 1.5 GHz Min**
- **Guaranteed 50-Ohm Insertion Power Gain $|S_{21e}|^2$
... 8.5 dB Min at 400 MHz**
- **Operation over the Entire Military Temperature
Range ... -65°C to 125°C**

***mechanical data**

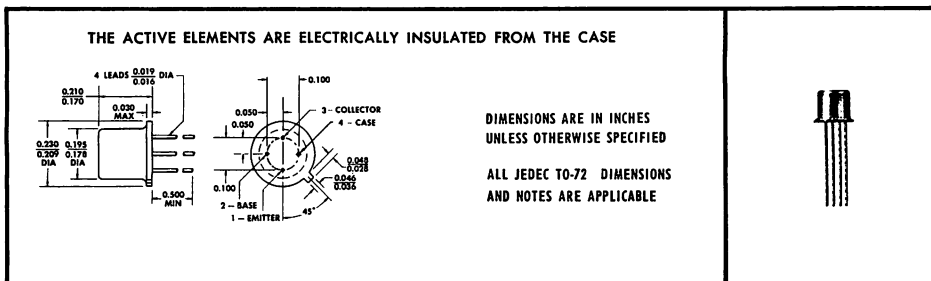

***absolute maximum ratings at 25°C free-air temperature (unless otherwise noted)**

Collector-Base Voltage	-15 V
Collector-Emitter Voltage (See Note 1)	-7 V
Emitter-Base Voltage	-0.3 V
Continuous Collector Current	-30 mA
Continuous Device Dissipation at (or below) 100°C Free-Air Temperature (See Note 2)	30 mW
Storage Temperature Range	-65°C to 125°C
Lead Temperature 1/8 Inch from Case for 10 Seconds	230°C

NOTES: 1. This value applies between 0 and 3 mA collector current when the emitter-base diode is open-circuited.
2. Derate linearly to 125°C free-air temperature at the rate of 1.2 mW/deg.

*Indicates JEDEC registered data

TYPES 2N5043, 2N5044

P-N-P EPITAXIAL PLANAR GERMANIUM TRANSISTORS

*electrical characteristics at 25°C free-air temperature (unless otherwise noted)

PARAMETER	TEST CONDITIONS	2N5043		2N5044		UNIT
		MIN	MAX	MIN	MAX	
$V_{(BR)CBO}$ Collector-Base Breakdown Voltage	$I_C = -100 \mu A, I_E = 0$	-15		-15		V
$V_{(BR)CEO}$ Collector-Emitter Breakdown Voltage	$I_C = -3 \text{ mA}, I_B = 0$	-7		-7		V
$V_{(BR)EBO}$ Emitter-Base Breakdown Voltage	$I_E = -100 \mu A, I_C = 0$	-0.3		-0.3		V
I_{CBO} Collector Cutoff Current	$V_{CB} = -10 \text{ V}, I_E = 0$		-6		-6	μA
h_{FE} Static Forward Current Transfer Ratio	$V_{CE} = -5 \text{ V}, I_C = -3 \text{ mA}$	15	150	15	150	
$ h_{fo} $ Small-Signal Common-Emitter Forward Current Transfer Ratio	$V_{CE} = -5 \text{ V}, I_C = -3 \text{ mA}, f = 400 \text{ MHz}$	3.75	7.5	2.5	6.25	
$ S_{21e} ^2$ Unneutralized Small-Signal Common-Emitter Insertion Power Gain	$V_{CE} = -5 \text{ V}, I_C = -3 \text{ mA}, Z_E = Z_L = 50 \Omega + j0, f = 400 \text{ MHz}$	8.5	12.5	6.5	10.5	dB
C_{cb} Collector-Base Capacitance	$V_{CB} = -5 \text{ V}, I_E = 0, f = 1 \text{ MHz}$, See Note 3	0.2	1	0.2	1	pF

*operating characteristics at 25°C free-air temperature

PARAMETER	TEST CONDITIONS	2N5043		2N5044		UNIT
		MIN	MAX	MIN	MAX	
NF Common-Emitter Spot Noise Figure	$V_{CB} = -5 \text{ V}, I_E = 3 \text{ mA}, R_G = 50 \Omega, f = 400 \text{ MHz}$, See Note 4	1	2.5	1	3.5	dB

NOTES: 3. C_{cb} is measured using three-terminal measurement techniques with the case and emitter guarded.

4. This noise figure measurement is made using a temperature-limited noise diode (Hewlett-Packard VHF Noise Source, Type 343A, or equivalent) operated according to the manufacturer's specification.

*Indicates JEDEC registered data

PARAMETER MEASUREMENT INFORMATION

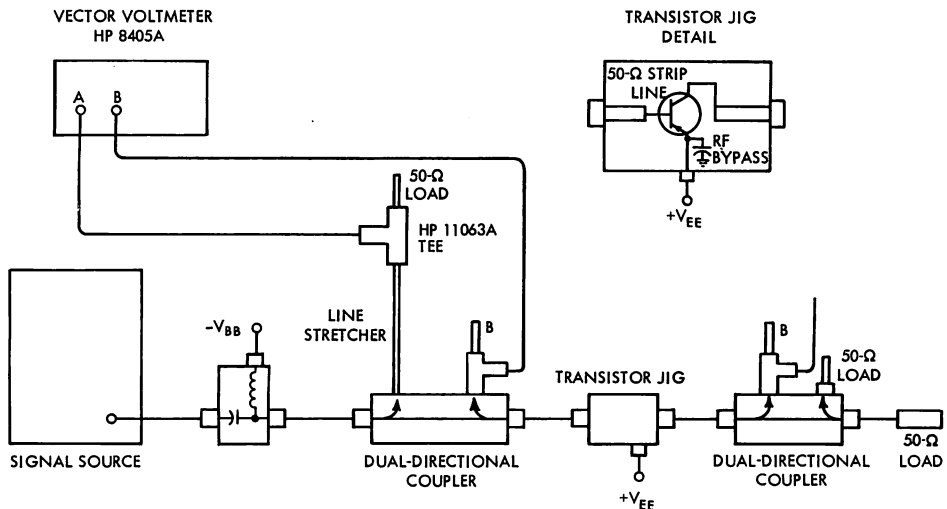

FIGURE 1—BLOCK DIAGRAM OF A TYPICAL S-PARAMETER MEASUREMENT SYSTEM

TYPES 2N5043, 2N5044 P-N-P EPITAXIAL PLANAR GERMANIUM TRANSISTORS

TYPICAL CHARACTERISTICS

SMALL-SIGNAL COMMON-EMITTER S PARAMETERS

$$V_{CE} = -5 \text{ V}, I_C = -3 \text{ mA}, Z_G = Z_L = 50 \text{ ohms} + j0, T_A = 25^\circ\text{C}$$

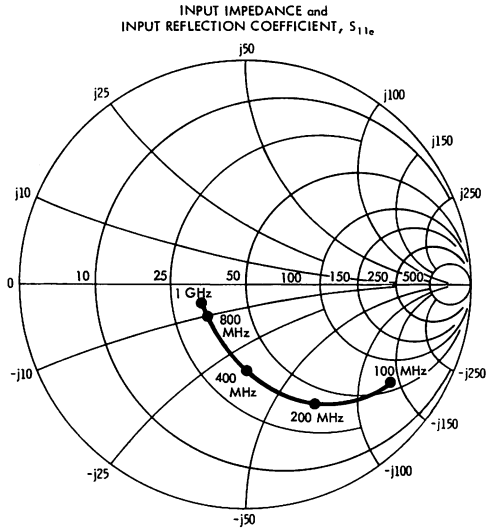

FIGURE 2

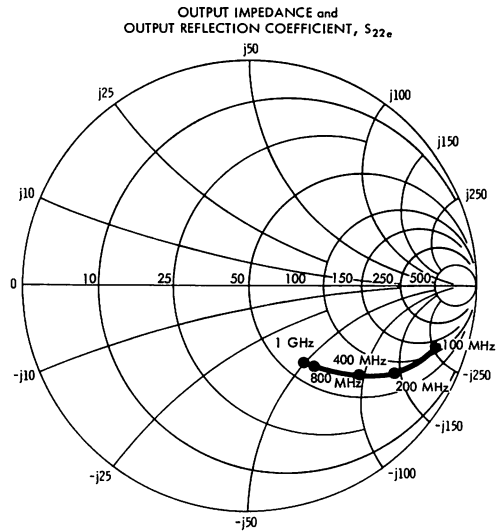

FIGURE 3

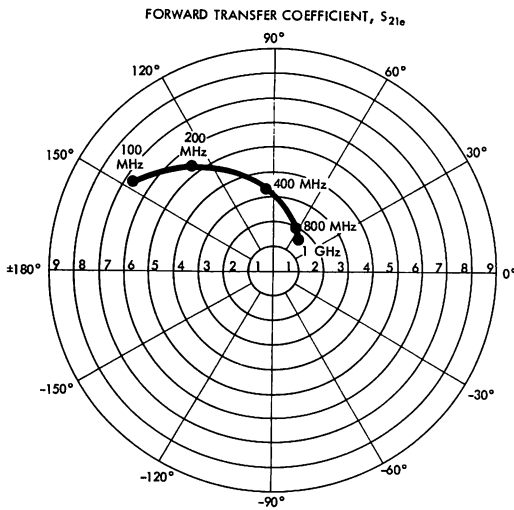

FIGURE 4

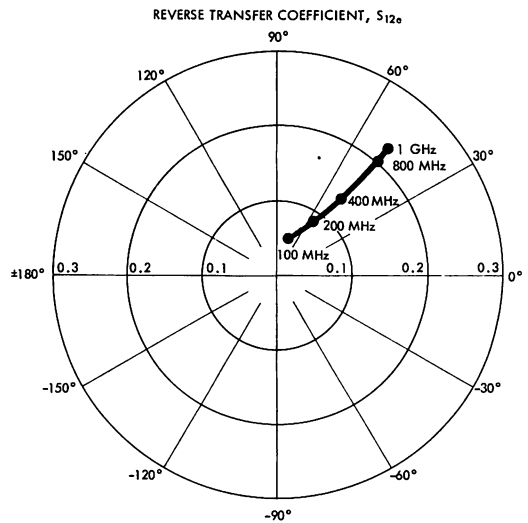

FIGURE 5

TYPES 2N5043, 2N5044

P-N-P EPITAXIAL PLANAR GERMANIUM TRANSISTORS

TYPICAL CHARACTERISTICS

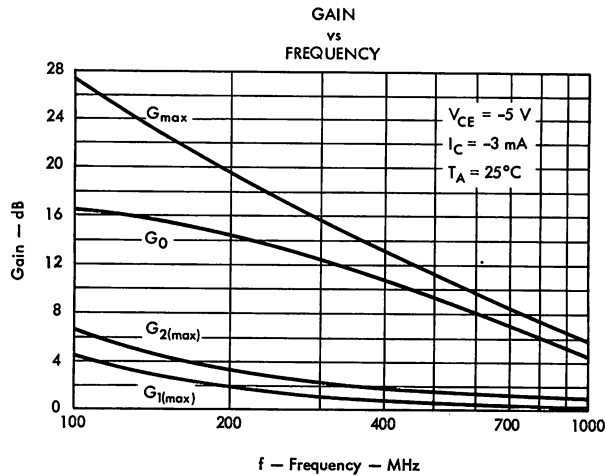

FIGURE 6

G_{max} is the gain equal to the sum of G_0 , $G_{1(max)}$, and $G_{2(max)}$. G_{max} is achieved when the input and output of the transistor are terminated in the complex conjugates of S_{11e} and S_{22e} respectively. G_{max} is calculated using the expression:

$$G_{max} = 10 \log \frac{|S_{21e}|^2}{(1 - |S_{11e}|^2)(1 - |S_{22e}|^2)}$$

G_0 is the forward power gain with the input and output terminated in 50 ohms. G_0 is calculated using the expression:

$$G_0 = 10 \log |S_{21e}|^2$$

$G_{1(max)}$ is the additional power gain resulting from conjugately matching the generator to S_{11e} . $G_{1(max)}$ is calculated using the expression:

$$G_{1(max)} = 10 \log \frac{1}{1 - |S_{11e}|^2}$$

$G_{2(max)}$ is the additional power gain resulting from conjugately matching the load to S_{22e} . $G_{2(max)}$ is calculated using the expression:

$$G_{2(max)} = 10 \log \frac{1}{1 - |S_{22e}|^2}$$

These expressions assume that the value of $|S_{12e}|$ is so small that its effect is negligible.

In general, gain is the sum of G_0 , G_1 , and G_2 and can be calculated from the data given in figures 6 through 14 when generator and load impedances are known.

TYPES 2N5043, 2N5044 P-N-P EPITAXIAL PLANAR GERMANIUM TRANSISTORS

TYPICAL CHARACTERISTICS

CIRCLES OF CONSTANT G_1

$V_{CE} = -5 \text{ V}$, $I_C = -3 \text{ mA}$, $T_A = 25^\circ\text{C}$

Generator Impedances in Ohms

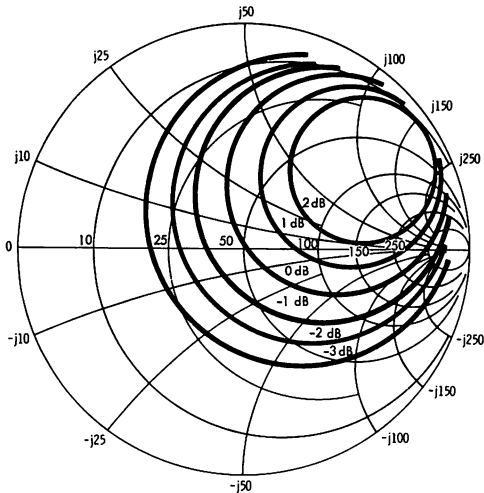

100 MHz
FIGURE 7

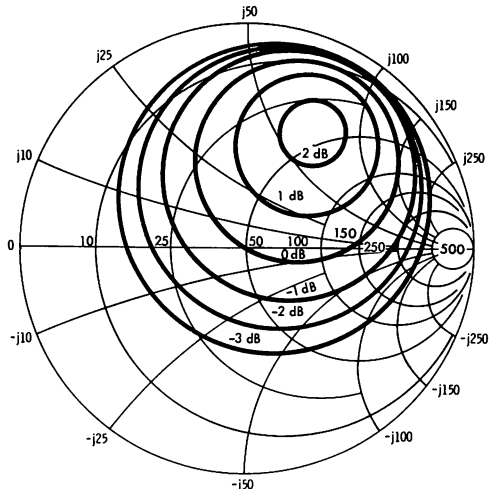

200 MHz
FIGURE 8

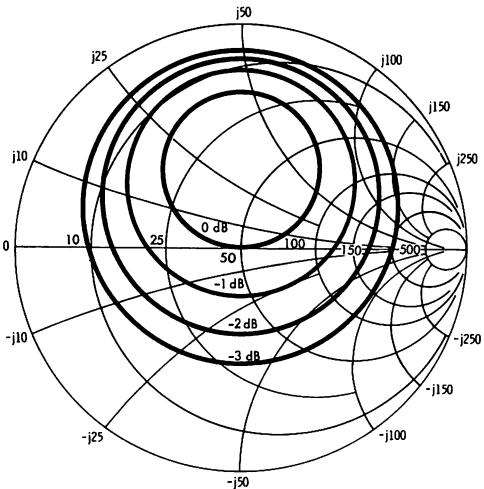

400 MHz
FIGURE 9

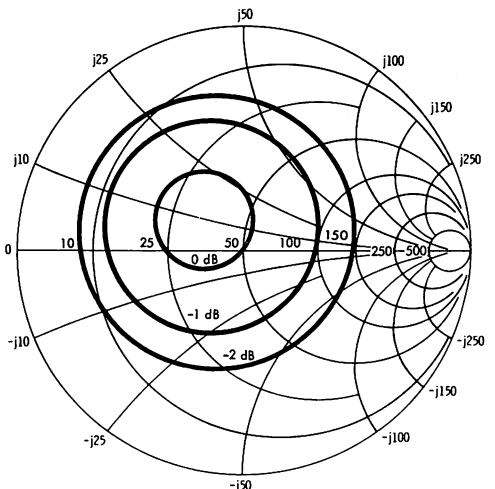

800 MHz
FIGURE 10

TYPES 2N5043, 2N5044 P-N-P EPITAXIAL PLANAR GERMANIUM TRANSISTORS

TYPICAL CHARACTERISTICS

CIRCLES OF CONSTANT G_2
 $V_{CE} = -5 \text{ V}$, $I_C = -3 \text{ mA}$, $T_A = 25^\circ\text{C}$
 Load Impedances in Ohms

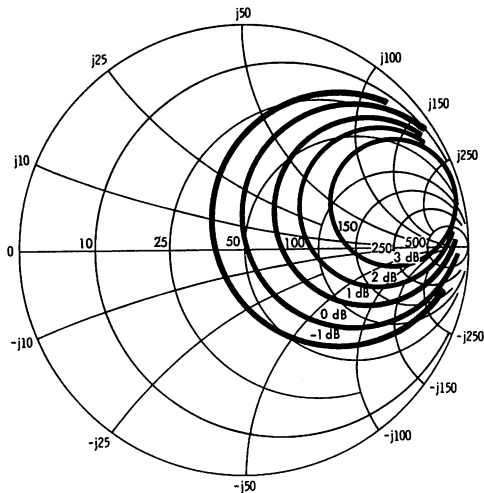

100 MHz
FIGURE 11

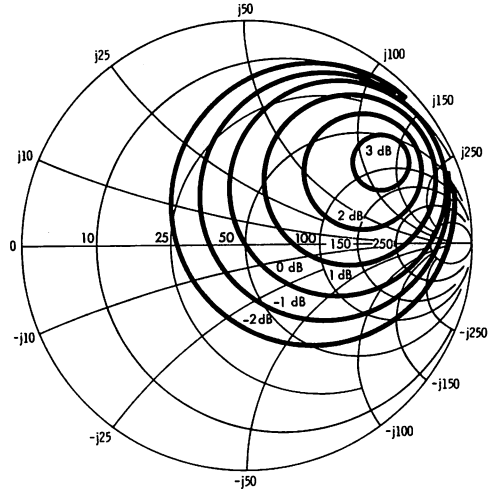

200 MHz
FIGURE 12

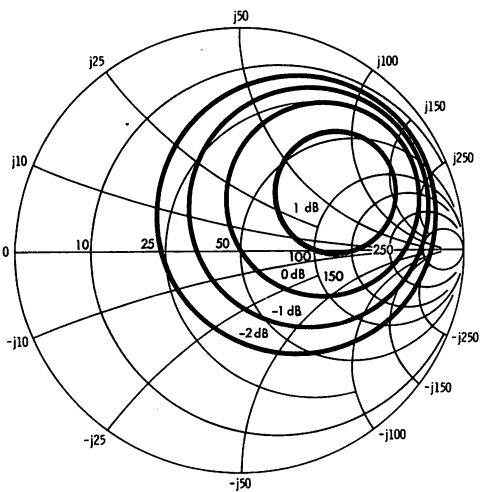

400 MHz
FIGURE 13

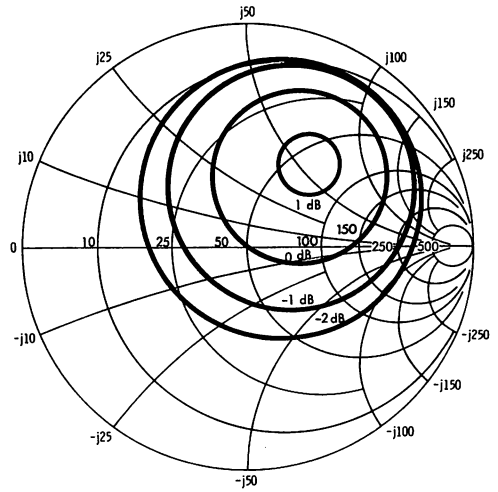

800 MHz
FIGURE 14

TYPES 2N5043, 2N5044 P-N-P EPITAXIAL PLANAR GERMANIUM TRANSISTORS

TYPICAL CHARACTERISTICS

CONTOURS OF CONSTANT SMALL-SIGNAL COMMON-EMITTER
FORWARD CURRENT TRANSFER RATIO, $|h_{fe}|$

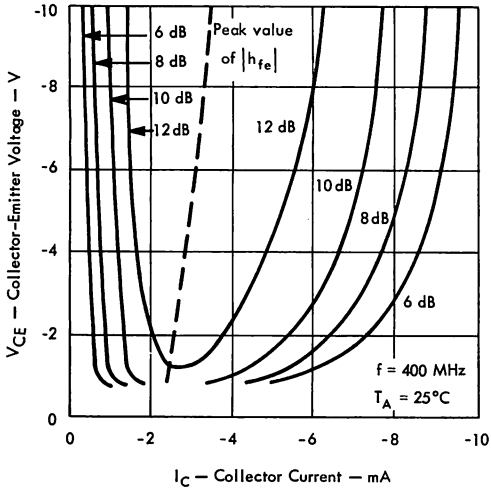

FIGURE 15

COMMON-EMITTER SPOT NOISE FIGURE
vs
FREQUENCY

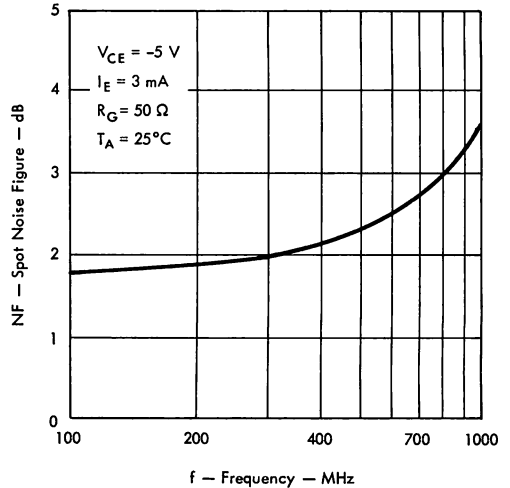

FIGURE 16

COMMON-EMITTER SPOT NOISE FIGURE DEVIATION
vs
FREE-AIR TEMPERATURE

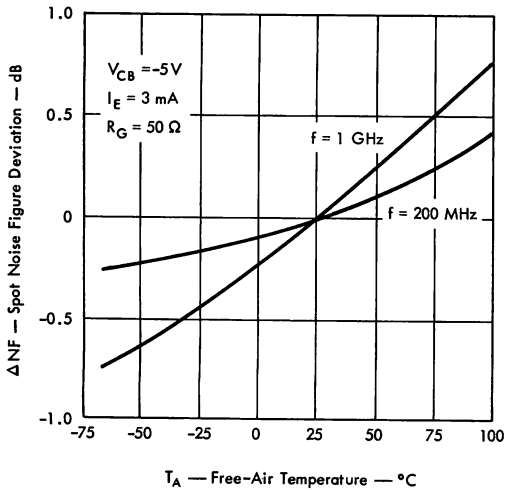

FIGURE 17

COMMON-EMITTER SPOT NOISE FIGURE
vs
EMITTER CURRENT

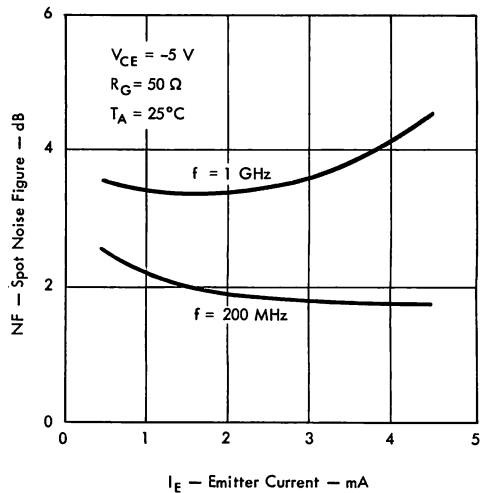

FIGURE 18

AUTHORIZED DISTRIBUTORS

FOR TEXAS INSTRUMENTS COMPONENTS GROUP

ALABAMA

ACK SEMICONDUCTORS INC.
3101 Fourth Ave. South/(205) FA 2-0588
Birmingham, Alabama 35233

ELECTRONIC WHOLESALERS, INC.
2310 Bob Wallace Avenue, S.W.
(205) 534-2461
Huntsville, Alabama 35805

ARIZONA

KIERULFF ELECTRONICS, INC.
2633 East Buckeye Road
(602) 273-7331
Phoenix, Arizona 85034

R. V. WEATHERFORD COMPANY
1917 North 25 Drive/(602) 272-7144
Carson Industrial Center
Phoenix, Arizona

CALIFORNIA

CALIFORNIA ELECTRONICS SUPPLY, INC.
1911 Armacost Avenue/(213) TR 9-0760
West Los Angeles, California 90025

KIERULFF ELECTRONICS, INC.
3969 E. Bayshore/(415) 968-6292
Palo Alto, California 94303

MIL OF CALIFORNIA
2060 India St./(714) BE 2-8951
San Diego, California 92101

RADIO PRODUCTS SALES, INC.
1501 S. Hill St./(213) RI 8-1271
Los Angeles, California 90015

R. V. WEATHERFORD COMPANY
1651 S. State College Blvd.
(714) KI 7-7521
Anaheim, California 92805

6921 San Fernando Rd./(213) VI 9-3451
Glendale, California 91201
3240 Hillview Drive
Stanford Industrial Park
(415) DA 1-5373
Palo Alto, California 94304

TI SUPPLY COMPANY
1651 Tenth Street/(213) 393-6731
Santa Monica, California 90404

COLORADO

TI SUPPLY COMPANY
2186 S. Holly/(303) 757-7671
Denver, Colorado 80222

FLORIDA

ELECTRONIC WHOLESALERS, INC.
345 Graham Ave./(305) 841-1550
Orlando, Florida 32814

9390 N. W. 27th Ave./(305) OX 6-1620
Miami, Florida 33147

ILLINOIS

ALLIED ELECTRONICS CORPORATION
100 N. Western Ave./(312) TA 9-9100
Chicago, Illinois 60680

MERQUIP ELECTRONICS, INC.
7701 No. Austin Ave./(312) 965-7500
Skokie, Illinois 60076

NEWARK ELECTRONICS CORP.
500 N. Pulaski Road/(312) 638-4411
Chicago, Illinois 60624

TI SUPPLY COMPANY
7135 N. Barry Avenue/(312) 296-7187
Des Plaines, Illinois 60018

INDIANA

ESCO ELECTRONICS INC.
2442 N. Shadeland Ave./(317) 357-8791
Indianapolis, Indiana 46219

RADIO DISTRIBUTING COMPANY
814 North Senate Avenue
(317) 637-5571
Indianapolis, Indiana 46204

IOWA

DEECO, INC.
618 First St., N. W./(319) EM 5-7551
Cedar Rapids, Iowa 72405

LOUISIANA

ELECTRONIC PRODUCTS CORPORATION
3622 Toulouse St./(504) HU 6-3777
New Orleans, Louisiana 70119

MARYLAND

ELECTRONIC WHOLESALERS, INC.
3200 Wilkens Ave./(301) 646-3600
Baltimore, Maryland 21223

MILGRAY/WASHINGTON
5405 Lafayette Place/(202) 864-1111
Hyattsville, Maryland 20781

MASSACHUSETTS

DEMAMBRO ELECTRONICS
1095 Commonwealth Ave.
(617) 787-1200
Boston, Massachusetts 02215

TI SUPPLY COMPANY
480 Neponset Road/(617) 828-5020
Canton, Massachusetts 02021

LAFAYETTE INDUSTRIAL ELECTRONICS
1400 Worcester Rd./(617) 969-6100
Natick, Massachusetts 01760

MILGRAY/NEW ENGLAND INC.
75 Terrace Hall Avenue/(617) 272-6800
Burlington, Massachusetts 02021

MICHIGAN

NEWARK-DETROIT ELECTRONICS, INC.
20700 Hubbell Ave./(313) 548-0250
Detroit, Michigan 48237

NEWARK-INDUSTRIAL
ELECTRONICS CORP.
2114 So. Division/(616) CH 1-5695
Grand Rapids, Michigan 49507

MINNESOTA

STARK ELECTRONIC SUPPLY CO.
112 Third Avenue N/(612) FE 2-1325
Minneapolis, Minnesota 55401

MISSOURI

TI SUPPLY COMPANY
2916 Holmes Street/(816) 753-4750
Kansas City, Missouri 64109

ELECTRONIC COMPONENTS FOR
INDUSTRY
2605 South Hanley Rd./(314) MI 7-5505
St. Louis, Missouri 63144

NEW JERSEY

GENERAL RADIO SUPPLY COMPANY, INC.
600 Penn St./(609) WO 4-8560
Camden, New Jersey 08102

TI SUPPLY COMPANY
301 Central Ave./(201) 382-6400
Clark, N. J. 07066

NEW MEXICO

KIERULFF ELECTRONICS, INC.
2524 Baylor Dr. S.E./(505) 247-1055
Albuquerque, New Mexico 87108

NEW YORK

GENESEE RADIO & PARTS CO., INC.
2550 Delaware Ave./(716) TR 3-9661
Buffalo, New York 14216

LAFAYETTE INDUSTRIAL ELECTRONICS
165-08 Liberty Ave./(212) 658-5050
Jamaica, New York 11431

MILGRAY/NEW YORK
160 Varick St./(212) YU 9-1600
New York, New York 10013

ROCHESTER RADIO SUPPLY CO., INC.
140 W. Main St./(716) 454-7800
Rochester, New York 14614

TI SUPPLY COMPANY
4 Nevada Dr./(516) 488-3300
New Hyde Park, L. I., N. Y. 11040

NORTH CAROLINA

ELECTRONIC WHOLESALERS, INC.
938 Burke St./(919) PA 5-8711
Winston-Salem, North Carolina 27101

OHIO

ESCO ELECTRONICS INC.
3130 Valleywood Drive/(513) 298-0191
Dayton, Ohio 45429

MILGRAY/CLEVELAND
1821 East 40th Street/(216) 881-8800
Cleveland, Ohio 44102

NEWARK-HERRLINGER
ELECTRONICS CORP.
112 E. Liberty St./(513) GA 1-5282
Cincinnati, Ohio 45210

W. M. PATTISON SUPPLY CO.
4550 Willow Parkway/(216) 441-3000
Cleveland, Ohio 44125

SREPCO ELECTRONICS, INC.
314 Leo Street/(513) BA 4-3871
Dayton, Ohio 45404

OKLAHOMA

TI SUPPLY COMPANY
12151 E. Skelly Dr./(918) 437-4555
Tulsa, Oklahoma 74110

OREGON

ALMAC STROUM ELECTRONICS
CORPORATION
8888 S.W. Canyon Road/(503) 292-3534
Portland, Oregon 97225

PENNSYLVANIA

MILGRAY/DELAWARE VALLEY INC.
2532 N. Broad St./(215) BA 8-2000
Philadelphia, Penn. 19107

RPC ELECTRONICS
620 Alpha Dr./(412) 782-3770
RIDC Park
Pittsburgh, Pennsylvania 15238

TEXAS

TI SUPPLY COMPANY
6000 Denton Drive/(214) FL 7-6121
Dallas, Texas 75235

5240 Elm Street/(713) MO 6-2175
Houston, Texas 77036

HARRISON EQUIPMENT COMPANY, INC.
1422 San Jacinto St./(713) CA 4-9131
Houston, Texas 77001

MIDLAND SPECIALTY COMPANY
2235 Wyoming Ave./(915) KE 3-9555
El Paso, Texas 79903

UTAH

STANDARD SUPPLY COMPANY
225 E. Sixth South St./(801) EL 5-2971
Salt Lake City, Utah 84110

WASHINGTON

ALMAC-STROUM ELECTRONICS
5811 Sixth Ave. So./(206) 763-2300
Seattle, Washington 98108

WASHINGTON, D.C.

ELECTRONIC WHOLESALERS, INC.
2345 Sherman Ave., N. W.
(202) HU 3-5200
Washington, D.C. 20001

CANADA

CANADIAN ELECTRONICS LTD.
Calgary, Alberta
Edmonton, Alberta
Lethbridge, Alberta
Medicine Hat, Alberta
Vancouver, B. C.

CESCO ELECTRONICS LTD.
Downsview, Quebec
Quebec, Quebec
Ottawa, Ontario
Toronto, Ontario
TI SUPPLY COMPANY
Dorval, Quebec

WELLINGTON, New Zealand
W. G. LEATHAM LTD.

AUSTRALIAN TI DISTRIBUTOR

MELBOURNE, Australia
RADIO PARTS PTY, LTD.
PERTH, Australia
PRECISION ELECTRONICS
BRISBANE, Australia
DOUGLAS ELECTRONICS

EUROPEAN TI DISTRIBUTORS

BRUSSELS IV, Belgium
S.A. AVI-ELEC N.V.

COPENHAGEN V, Denmark
TEXAS INSTRUMENTS A/S

HELSINKI, Finland
OY CHESTER AB

HAMBURG, West Germany
FIRMA ALFRED NEYE, ENATECHNIK

STUTTGART, WEST GERMANY
TI SUPPLY CO.

OSLO, Norway
MORGENSTIERNE & CO.

STOCKHOLM, Sweden
AB GOSTA BACKSTROM

ZURICH 32, Switzerland
FABRIMEX AG ZURICH

PARIS, FRANCE
TI SUPPLY CO.

MILANO, ITALY
TI SUPPLY CO.

MANCHESTER, ENGLAND
TI SUPPLY CO.

TYPES TIP29, TIP29A N-P-N SINGLE-DIFFUSED SILICON POWER TRANSISTORS



TIP29, TIP29A
BULLETIN NO. DL-5 6810954, JULY 1968

**FOR POWER-AMPLIFIER AND HIGH-SPEED-SWITCHING APPLICATIONS
DESIGNED FOR COMPLEMENTARY USE WITH TIP30, TIP30A**

- 30 Watts at 25°C Case Temperature
- 1 A Rated Collector Current
- Min f_T of 3 MHz at 10 V, 200 mA

mechanical data

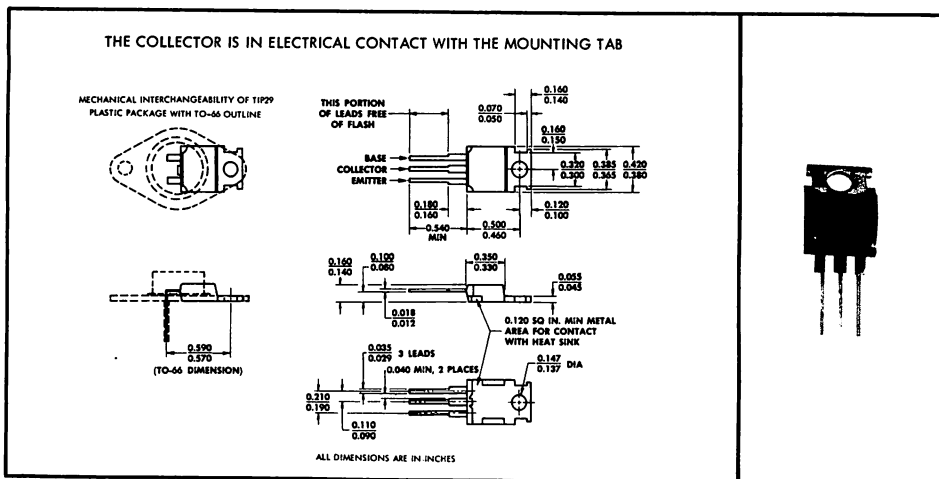

absolute maximum ratings at 25°C case temperature (unless otherwise noted)

	TIP29	TIP29A
Collector-Base Voltage	40 V	60 V
Collector-Emitter Voltage (See Note 1)	40 V	60 V
Emitter-Base Voltage	← 5 V →	← 5 V →
Continuous Collector Current	← 1 A →	← 1 A →
Continuous Base Current	← 0.4 A →	← 0.4 A →
Safe Operating Region at (or below) 25°C Case Temperature	See Figure 2	
Continuous Device Dissipation at (or below) 25°C Case Temperature (See Note 2)	← 30 W →	← 30 W →
Continuous Device Dissipation at (or below) 25°C Free-Air Temperature (See Note 3)	← 2 W →	← 2 W →
Operating Collector Junction Temperature Range	-65°C to 150°C	
Storage Temperature Range	-65°C to 150°C	
Lead Temperature 1/8 Inch from Case for 10 Seconds	← 260°C →	

NOTES: 1. These values apply when the base-emitter diode is open-circuited.
 2. Derate linearly to 150°C case temperature at the rate of 0.24 W/deg.
 3. Derate linearly to 150°C free-air temperature at the rate of 16 mW/deg.

TYPES TIP29, TIP29A

N-P-N SINGLE-DIFFUSED SILICON POWER TRANSISTORS

electrical characteristics at 25°C case temperature

PARAMETER	TEST CONDITIONS	TIP29		TIP29A		UNIT
		MIN	MAX	MIN	MAX	
$V_{(BR)CEO}$ Collector-Emitter Breakdown Voltage	$I_C = 30 \text{ mA}$, $I_B = 0$, See Note 4	40		60		V
I_{CEO} Collector Cutoff Current	$V_{CE} = 30 \text{ V}$, $I_B = 0$	0.3		0.3		mA
I_{CES} Collector Cutoff Current	$V_{CE} = 40 \text{ V}$, $V_{BE} = 0$	0.2				mA
	$V_{CE} = 60 \text{ V}$, $V_{BE} = 0$			0.2		
I_{EBO} Emitter Cutoff Current	$V_{EB} = 5 \text{ V}$, $I_C = 0$	1		1		mA
h_{FE} Static Forward Current Transfer Ratio	$V_{CE} = 4 \text{ V}$, $I_C = 0.2 \text{ A}$, See Notes 4 and 5	40	200	40	200	
	$V_{CE} = 4 \text{ V}$, $I_C = 1 \text{ A}$, See Notes 4 and 5	10		10		
V_{BE} Base-Emitter Voltage	$V_{CE} = 4 \text{ V}$, $I_C = 1 \text{ A}$, See Notes 4 and 5	1.3		1.3		V
$V_{CE(sat)}$ Collector-Emitter Saturation Voltage	$I_B = 125 \text{ mA}$, $I_C = 1 \text{ A}$, See Notes 4 and 5	0.7		0.7		V
h_{fo} Small-Signal Common-Emitter Forward Current Transfer Ratio	$V_{CE} = 10 \text{ V}$, $I_C = 0.2 \text{ A}$, $f = 1 \text{ kHz}$	20		20		
$ h_{fo} $ Small-Signal Common-Emitter Forward Current Transfer Ratio	$V_{CE} = 10 \text{ V}$, $I_C = 0.2 \text{ A}$, $f = 1 \text{ MHz}$	3		3		

NOTES: 4. These parameters must be measured using pulse techniques. $t_p \leq 300 \mu\text{s}$, duty cycle $\leq 2\%$.

Pulse width must be such that halving or doubling does not cause a change greater than the required accuracy of the measurement.

5. These parameters are measured with voltage-sensing contacts separate from the current-carrying contacts.

thermal characteristics

PARAMETER	MAX	UNIT
θ_{J-C} Junction-to-Case Thermal Resistance	4.17	deg/W
θ_{J-A} Junction-to-Free-Air Thermal Resistance	62.5	

switching characteristics at 25°C case temperature

PARAMETER	TEST CONDITIONS†	TYP	UNIT
t_{on} Turn-On Time	$I_C = 200 \text{ mA}$, $I_{B(1)} = 20 \text{ mA}$, $I_{B(2)} = -20 \text{ mA}$, $V_{BE(off)} = -3.4 \text{ V}$, $R_L = 150 \Omega$, See Figure 1	0.35	μs
t_{off} Turn-Off Time		1.10	

†Voltage and current values shown are nominal, exact values vary slightly with transistor parameters.

TYPES TIP29, TIP29A N-P-N SINGLE-DIFFUSED SILICON POWER TRANSISTORS

PARAMETER MEASUREMENT INFORMATION

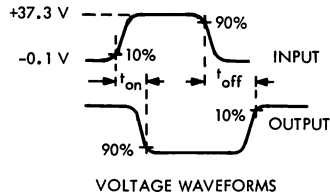
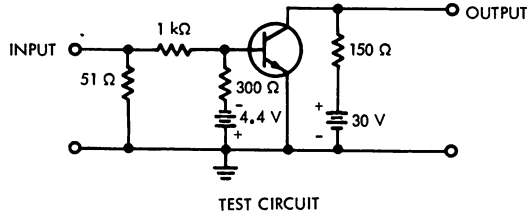
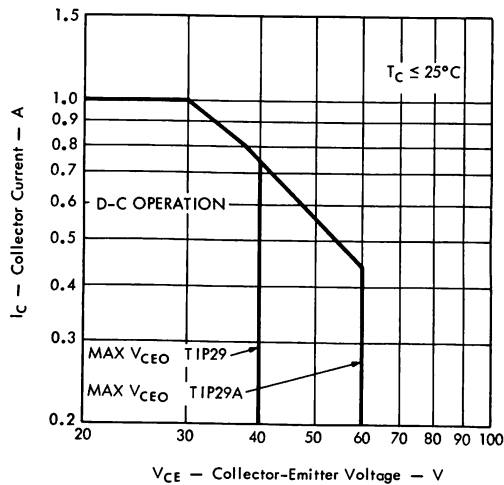

FIGURE 1

- NOTES: a. The input waveform is supplied by a generator with the following characteristics: $t_r \leq 15$ ns, $t_f \leq 15$ ns, $Z_{out} = 50 \Omega$, $t_p = 10 \mu$ s, duty cycle $\leq 2\%$.
 b. Waveforms are monitored on an oscilloscope with the following characteristics: $t_r \leq 15$ ns, $R_{in} \geq 10$ M Ω , $C_{in} \leq 11.5$ pF.
 c. Resistors must be noninductive types.
 d. The d-c power supplies may require additional bypassing in order to minimize ringing.

MAXIMUM SAFE OPERATING REGION



TYPES TIP29, TIP29A N-P-N SINGLE-DIFFUSED SILICON POWER TRANSISTORS

TYPICAL CHARACTERISTICS

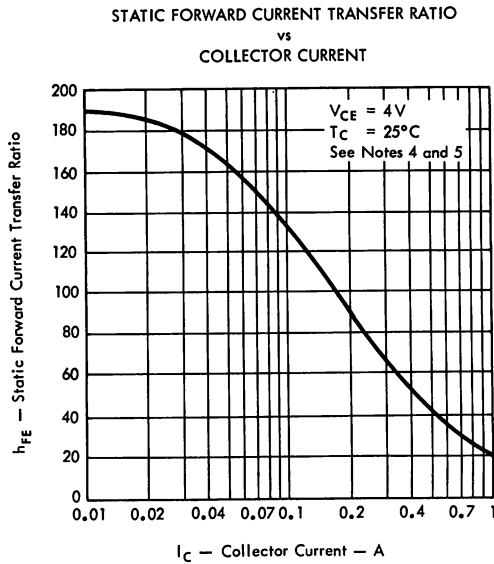

FIGURE 3

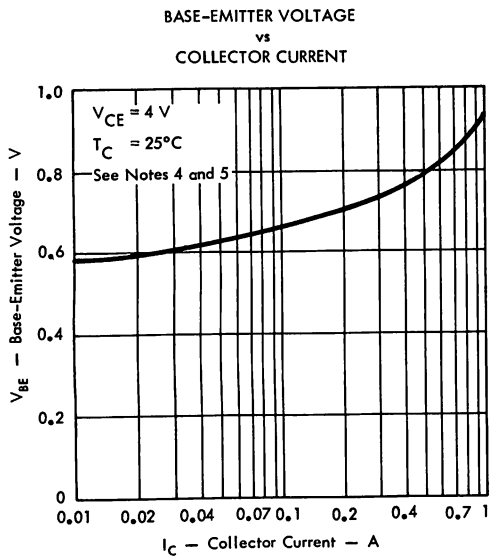

FIGURE 4

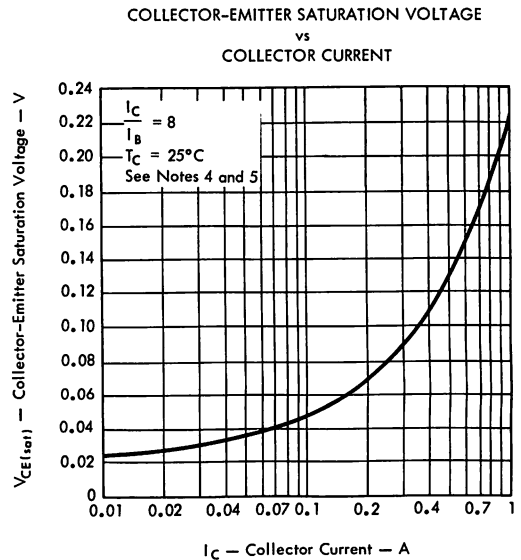

FIGURE 5

- NOTES: 4. These parameters must be measured using pulse techniques. $t_p \leq 300 \mu s$, duty cycle $\leq 2\%$. Pulse width must be such that halving or doubling does not cause a change greater than the required accuracy of the measurement.
5. These parameters are measured with voltage-sensing contacts separate from the current-carrying contacts.

TYPES TIP30, TIP30A P-N-P SINGLE-DIFFUSED SILICON POWER TRANSISTORS



**FOR POWER-AMPLIFIER AND HIGH-SPEED-SWITCHING APPLICATIONS
DESIGNED FOR COMPLEMENTARY USE WITH TIP29, TIP29A**

- 30 Watts at 25°C Case Temperature
- 1 A Rated Collector Current
- Min f_T of 3 MHz at 10 V, 200 mA

TYPES TIP30, TIP30A
BULLETIN NO. DL-5 6810956, JULY 1968

mechanical data

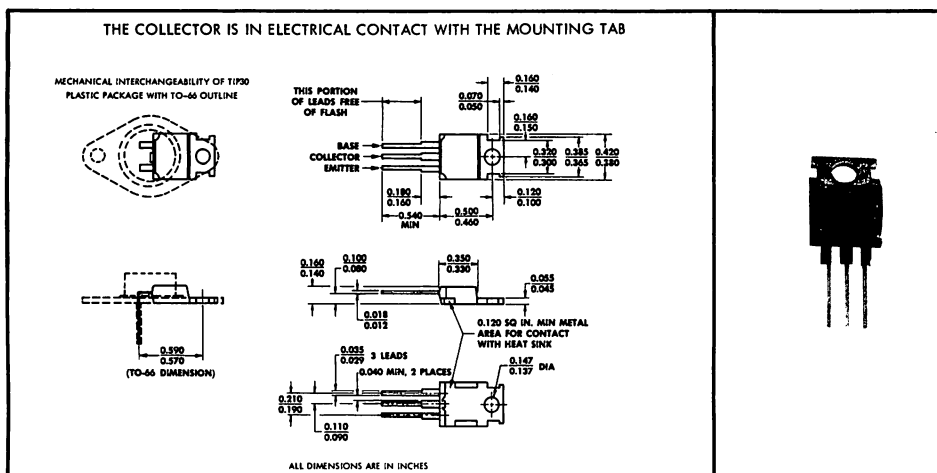

absolute maximum ratings at 25°C case temperature (unless otherwise noted)

	TIP30	TIP30A
Collector-Base Voltage	-40 V	-60 V
Collector-Emitter Voltage (See Note 1)	-40 V	-60 V
Emitter-Base Voltage	← -5 V →	← -5 V →
Continuous Collector Current	← -1 A →	← -1 A →
Continuous Base Current	← -0.4 A →	← -0.4 A →
Safe Operating Region at (or below) 25°C Case Temperature	See Figure 2	
Continuous Device Dissipation at (or below) 25°C Case Temperature (See Note 2)	← 30 W →	← 30 W →
Continuous Device Dissipation at (or below) 25°C Free-Air Temperature (See Note 3)	← 2 W →	← 2 W →
Operating Collector Junction Temperature Range	-65°C to 150°C	
Storage Temperature Range	-65°C to 150°C	
Lead Temperature 1/8 Inch from Case for 10 Seconds	← 260°C →	

- NOTES: 1. These values apply when the base-emitter diode is open-circuited.
2. Derate linearly to 150°C case temperature at the rate of 0.24 W/deg.
3. Derate linearly to 150°C free-air temperature at the rate of 16 mW/deg.



TEXAS INSTRUMENTS
INCORPORATED
POST OFFICE BOX 5012 • DALLAS, TEXAS 75222

TYPES TIP30, TIP30A

P-N-P SINGLE-DIFFUSED SILICON POWER TRANSISTORS

electrical characteristics at 25°C case temperature

PARAMETER	TEST CONDITIONS	TIP30		TIP30A		UNIT
		MIN	MAX	MIN	MAX	
$V_{(BR)CEO}$ Collector-Emitter Breakdown Voltage	$I_C = -30 \text{ mA}$, $I_B = 0$, See Note 4	-40		-60		V
I_{CEO} Collector Cutoff Current	$V_{CE} = -30 \text{ V}$, $I_B = 0$		-0.3		-0.3	mA
I_{CES} Collector Cutoff Current	$V_{CE} = -40 \text{ V}$, $V_{BE} = 0$		-0.2			
	$V_{CE} = -60 \text{ V}$, $V_{BE} = 0$				-0.2	mA
I_{EBO} Emitter Cutoff Current	$V_{EB} = -5 \text{ V}$, $I_C = 0$		-1		-1	
h_{FE} Static Forward Current Transfer Ratio	$V_{CE} = -4 \text{ V}$, $I_C = -0.2 \text{ A}$, See Notes 4 and 5	40	200	40	200	
	$V_{CE} = -4 \text{ V}$, $I_C = -1 \text{ A}$, See Notes 4 and 5	10		10		
V_{BE} Base-Emitter Voltage	$V_{CE} = -4 \text{ V}$, $I_C = -1 \text{ A}$, See Notes 4 and 5		-1.3		-1.3	V
$V_{CE(sat)}$ Collector-Emitter Saturation Voltage	$I_B = -125 \text{ mA}$, $I_C = -1 \text{ A}$, See Notes 4 and 5		-0.7		-0.7	V
h_{fe} Small-Signal Common-Emitter Forward Current Transfer Ratio	$V_{CE} = -10 \text{ V}$, $I_C = -0.2 \text{ A}$, $f = 1 \text{ kHz}$	20		20		
$ h_{fe} $ Small-Signal Common-Emitter Forward Current Transfer Ratio	$V_{CE} = -10 \text{ V}$, $I_C = -0.2 \text{ A}$, $f = 1 \text{ MHz}$	3		3		

NOTES: 4. These parameters must be measured using pulse techniques. $t_p \leq 300 \mu\text{s}$, duty cycle $\leq 2\%$.

Pulse width must be such that halving or doubling does not cause a change greater than the required accuracy of the measurement.

5. These parameters are measured with voltage-sensing contacts separate from the current-carrying contacts.

thermal characteristics

PARAMETER	MAX	UNIT
θ_{J-C} Junction-to-Case Thermal Resistance	4.17	deg/W
θ_{J-A} Junction-to-Free-Air Thermal Resistance	62.5	

switching characteristics at 25°C case temperature

PARAMETER	TEST CONDITIONS†	TYP	UNIT
t_{on} Turn-On Time	$I_C = -200 \text{ mA}$, $I_{B(1)} = -20 \text{ mA}$, $I_{B(2)} = 20 \text{ mA}$, $R_L = 150 \Omega$, See Figure 1	0.25	μs
t_{off} Turn-Off Time	$V_{BE(off)} = 3.4 \text{ V}$, $R_L = 150 \Omega$, See Figure 1	0.90	

†Voltage and current values shown are nominal; exact values vary slightly with transistor parameters.

TYPES TIP30, TIP30A P-N-P SINGLE-DIFFUSED SILICON POWER TRANSISTORS

PARAMETER MEASUREMENT INFORMATION

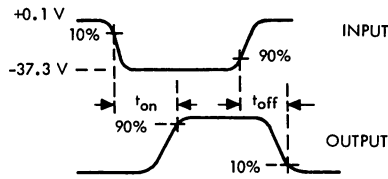
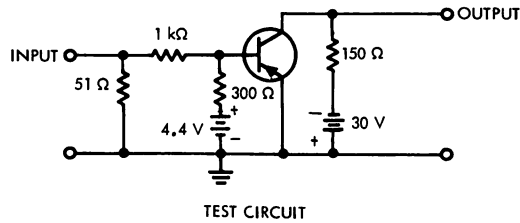
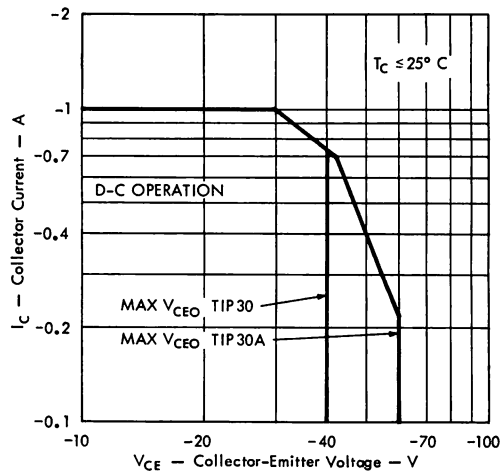

FIGURE 1

- NOTES:
- The input waveform is supplied by a generator with the following characteristics: $t_r \leq 15$ ns, $t_f \leq 15$ ns, $Z_{out} = 50 \Omega$, $t_p = 10 \mu$ s, duty cycle $\leq 2\%$.
 - Waveforms are monitored on an oscilloscope with the following characteristics: $t_r \leq 15$ ns, $R_{in} \geq 10$ M Ω , $C_{in} \leq 11.5$ pF.
 - Resistors must be noninductive types.
 - The d-c power supplies may require additional bypassing in order to minimize ringing.

MAXIMUM SAFE OPERATING REGION



TYPES TIP30, TIP30A

P-N-P SINGLE-DIFFUSED SILICON POWER TRANSISTORS

TYPICAL CHARACTERISTICS

STATIC FORWARD CURRENT TRANSFER RATIO
vs
COLLECTOR CURRENT

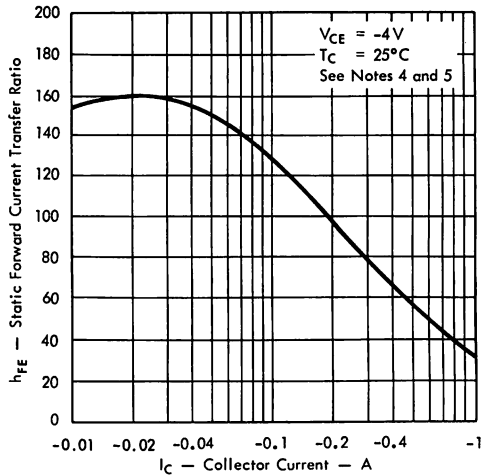

FIGURE 3

BASE-EMITTER VOLTAGE
vs
COLLECTOR CURRENT

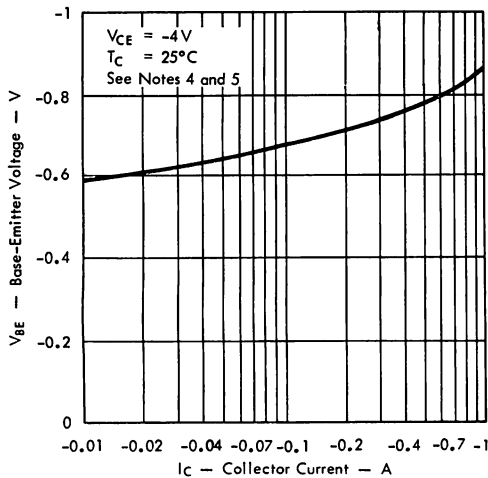

FIGURE 4

COLLECTOR-EMITTER SATURATION VOLTAGE
vs
COLLECTOR CURRENT

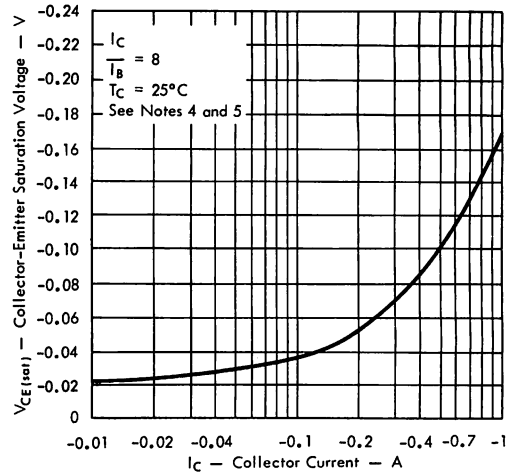

FIGURE 5

NOTES: 4. These parameters must be measured using pulse techniques. $t_p \leq 300 \mu s$, duty cycle $\leq 2\%$.

Pulse width must be such that halving or doubling does not cause a change greater than the required accuracy of the measurement.

5. These parameters are measured with voltage-sensing contacts separate from the current-carrying contacts.

TYPES TIP31, TIP31A N-P-N SINGLE-DIFFUSED SILICON POWER TRANSISTORS



TYPES TIP31, TIP31A
BULLETIN NO. DL-5-6810953, JULY 1968

**FOR POWER-AMPLIFIER AND HIGH-SPEED-SWITCHING APPLICATIONS
DESIGNED FOR COMPLEMENTARY USE WITH TIP32, TIP32A**

- 40 Watts at 25°C Case Temperature
- 3 A Rated Collector Current
- Min f_t of 3 MHz at 10 V, 500 mA

mechanical data

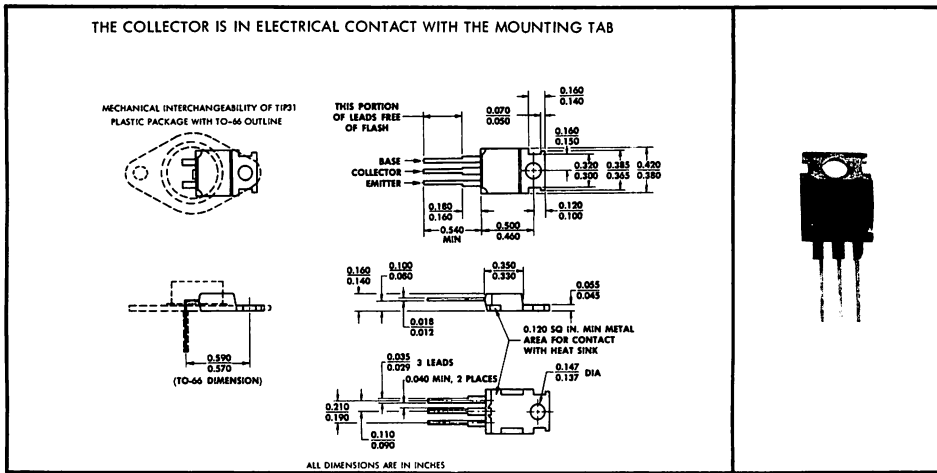

absolute maximum ratings at 25°C case temperature (unless otherwise noted)

	TIP31	TIP31A
Collector-Base Voltage	40 V	60 V
Collector-Emitter Voltage (See Note 1)	40 V	60 V
Emitter-Base Voltage	← 5 V →	← 5 V →
Continuous Collector Current	← 3 A →	← 3 A →
Continuous Base Current	← 1 A →	← 1 A →
Safe Operating Region at (or below) 25°C Case Temperature	See Figure 2	
Continuous Device Dissipation at (or below) 25°C Case Temperature (See Note 2)	← 40 W →	← 40 W →
Continuous Device Dissipation at (or below) 25°C Free-Air Temperature (See Note 3)	← 2 W →	← 2 W →
Operating Collector Junction Temperature Range	-65°C to 150°C	
Storage Temperature Range	-65°C to 150°C	
Lead Temperature 1/8 Inch from Case for 10 Seconds	← 260°C →	

- NOTES: 1. These values apply when the base-emitter diode is open-circuited.
 2. Derate linearly to 150°C case temperature at the rate of 0.32 W/deg.
 3. Derate linearly to 150°C free-air temperature at the rate of 16 mW/deg.



TEXAS INSTRUMENTS
INCORPORATED
POST OFFICE BOX 5012 • DALLAS, TEXAS 75222

TYPES TIP31, TIP31A

N-P-N SINGLE-DIFFUSED SILICON POWER TRANSISTORS

electrical characteristics at 25°C case temperature

PARAMETER	TEST CONDITIONS	TIP31		TIP31A		UNIT
		MIN	MAX	MIN	MAX	
$V_{(BR)CEO}$ Collector-Emitter Breakdown Voltage	$I_C = 50 \text{ mA}$, $I_B = 0$, See Note 4	40		60		V
I_{CEO} Collector Cutoff Current	$V_{CE} = 30 \text{ V}$, $I_B = 0$		0.5		0.5	mA
I_{CES} Collector Cutoff Current	$V_{CE} = 40 \text{ V}$, $V_{BE} = 0$		0.3			mA
	$V_{CE} = 60 \text{ V}$, $V_{BE} = 0$				0.3	
I_{EBO} Emitter Cutoff Current	$V_{EB} = 5 \text{ V}$, $I_C = 0$		1		1	mA
h_{FE} Static Forward Current Transfer Ratio	$V_{CE} = 4 \text{ V}$, $I_C = 1 \text{ A}$, See Notes 4 and 5	20	100	20	100	
	$V_{CE} = 4 \text{ V}$, $I_C = 3 \text{ A}$, See Notes 4 and 5	8		8		
V_{BE} Base-Emitter Voltage	$V_{CE} = 4 \text{ V}$, $I_C = 1 \text{ A}$, See Notes 4 and 5		1.3		1.3	V
	$V_{CE} = 4 \text{ V}$, $I_C = 3 \text{ A}$, See Notes 4 and 5		1.8		1.8	
$V_{CE(sat)}$ Collector-Emitter Saturation Voltage	$I_B = 100 \text{ mA}$, $I_C = 1 \text{ A}$, See Notes 4 and 5		0.6		0.6	V
	$I_B = 375 \text{ mA}$, $I_C = 3 \text{ A}$, See Notes 4 and 5		1.2		1.2	
h_{fo} Small-Signal Common-Emitter Forward Current Transfer Ratio	$V_{CE} = 10 \text{ V}$, $I_C = 0.5 \text{ A}$, $f = 1 \text{ kHz}$	20		20		
$ h_{fe} $ Small-Signal Common-Emitter Forward Current Transfer Ratio	$V_{CE} = 10 \text{ V}$, $I_C = 0.5 \text{ A}$, $f = 1 \text{ MHz}$	3		3		

NOTES: 4. These parameters must be measured using pulse techniques. $t_p \leq 300 \mu\text{s}$, duty cycle $\leq 2\%$.

Pulse width must be such that halving or doubling does not cause a change greater than the required accuracy of the measurement.

5. These parameters are measured with voltage-sensing contacts separate from the current-carrying contacts.

thermal characteristics

PARAMETER	MAX	UNIT
θ_{J-C} Junction-to-Case Thermal Resistance	3.125	deg/W
θ_{J-A} Junction-to-Free-Air Thermal Resistance	62.5	

switching characteristics at 25°C case temperature

PARAMETER	TEST CONDITIONS†	TYP	UNIT
t_{on} Turn-On Time	$I_C = 1 \text{ A}$, $I_{B(1)} = 100 \text{ mA}$, $I_{B(2)} = -100 \text{ mA}$,	0.45	μs
t_{off} Turn-Off Time	$V_{BE(off)} = -3.7 \text{ V}$, $R_L = 20 \Omega$, See Figure 1	0.65	

†Voltage and current values shown are nominal; exact values vary slightly with transistor parameters.

TYPES TIP31, TIP31A N-P-N SINGLE-DIFFUSED SILICON POWER TRANSISTORS

PARAMETER MEASUREMENT INFORMATION

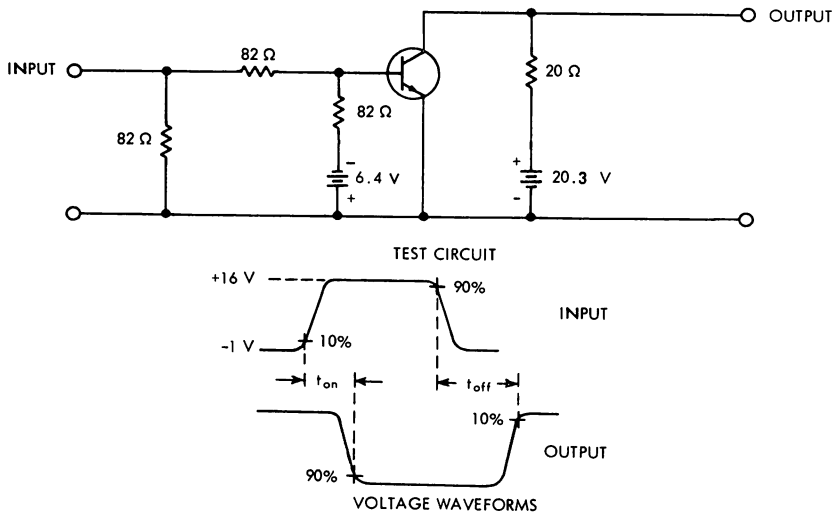

FIGURE 1

- NOTES:
- The input waveform is supplied by a generator with the following characteristics: $t_r \leq 15$ ns, $t_f \leq 15$ ns, $Z_{out} = 50 \Omega$, $t_p = 10 \mu$ s, duty cycle $\leq 2\%$
 - Waveforms are monitored on an oscilloscope with the following characteristics: $t_r \leq 15$ ns, $R_{in} \geq 10$ M Ω , $C_{in} \leq 11.5$ pF.
 - Resistors must be noninductive types.
 - The d-c power supplies may require additional bypassing in order to minimize ringing.

MAXIMUM SAFE OPERATING REGION

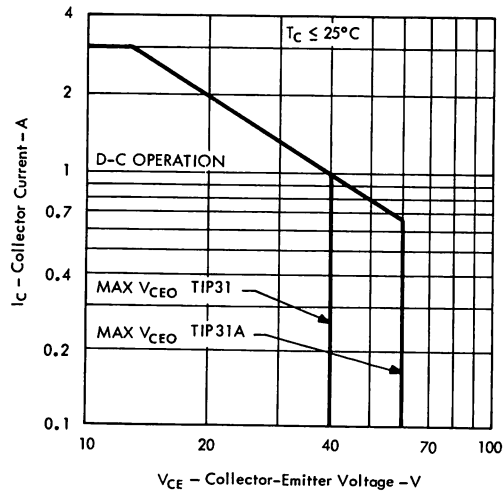

FIGURE 2

TYPES TIP31, TIP31A

N-P-N SINGLE-DIFFUSED SILICON POWER TRANSISTORS

TYPICAL CHARACTERISTICS

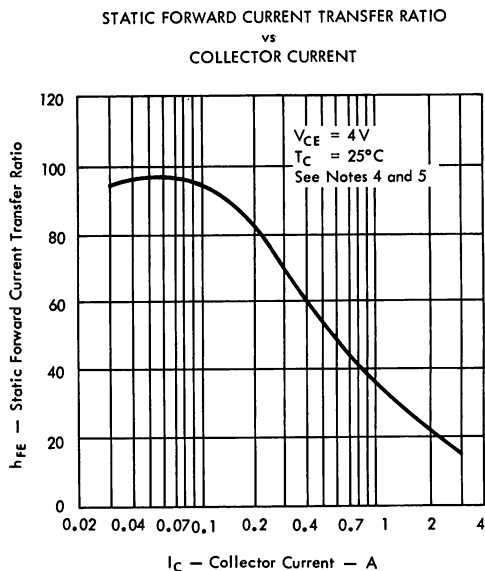

FIGURE 3

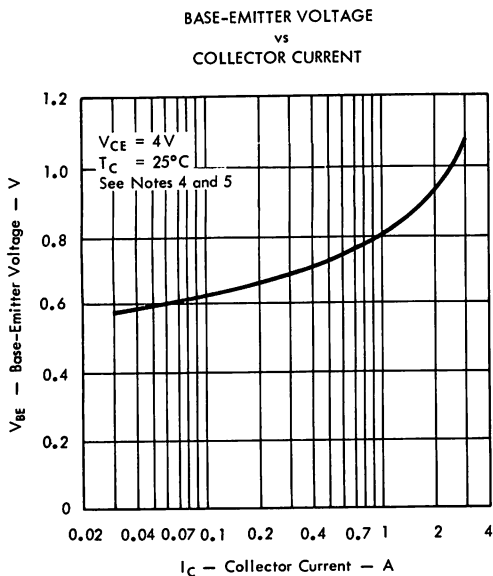

FIGURE 4

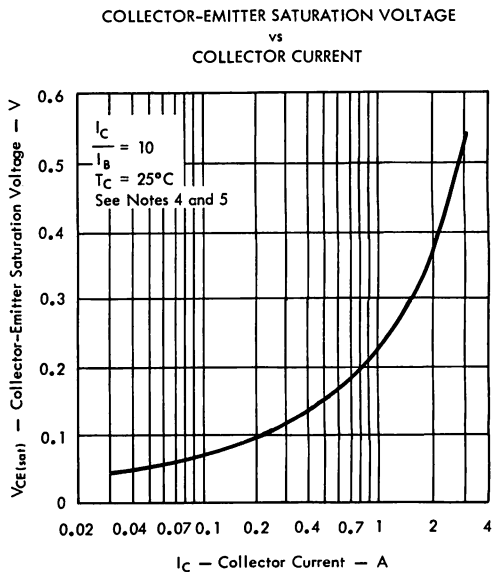

FIGURE 5

NOTES: 4. These parameters must be measured using pulse techniques. $t_p \leq 300 \mu s$, duty cycle $\leq 2\%$.

Pulse width must be such that halving or doubling does not cause a change greater than the required accuracy of the measurement.

5. These parameters are measured with voltage-sensing contacts separate from the current-carrying contacts.

TYPES TIP32, TIP32A P-N-P SINGLE-DIFFUSED SILICON POWER TRANSISTORS



FOR POWER-AMPLIFIER AND HIGH-SPEED-SWITCHING APPLICATIONS
DESIGNED FOR COMPLEMENTARY USE WITH TIP31, TIP31A

- 40 Watts at 25°C Case Temperature
- 3 A Rated Collector Current
- Min f_T of 3 MHz at 10 V, 500 mA

TYPES TIP32, TIP32A
BULLETIN NO. DL-5-6810952, JULY 1968

mechanical data

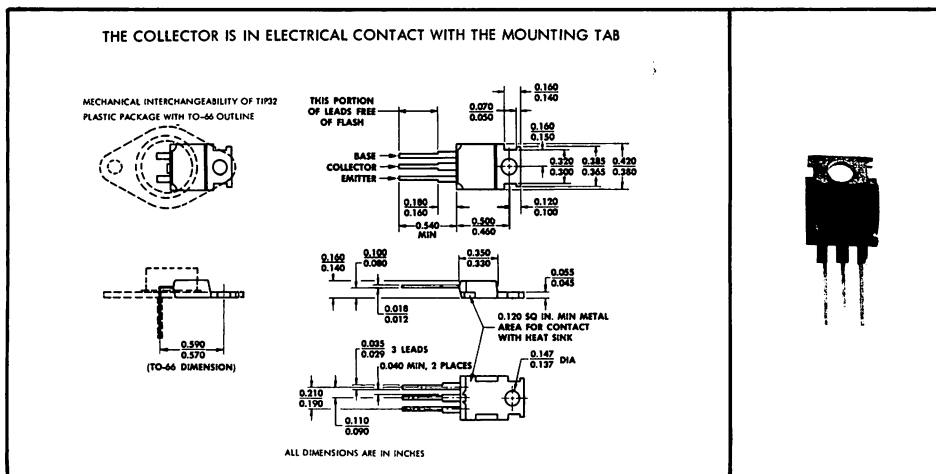

absolute maximum ratings at 25°C case temperature (unless otherwise noted)

	TIP32	TIP32A
Collector-Base Voltage	-40 V	-60 V
Collector-Emitter Voltage (See Note 1)	-40 V	-60 V
Emitter-Base Voltage	← -5 V →	← -5 V →
Continuous Collector Current	← -3 A →	← -3 A →
Continuous Base Current	← -1 A →	← -1 A →
Safe Operating Region at (or below) 25°C Case Temperature	See Figure 2	
Continuous Device Dissipation at (or below) 25°C Case Temperature (See Note 2)	← 40 W →	← 40 W →
Continuous Device Dissipation at (or below) 25°C Free-Air Temperature (See Note 3)	← 2 W →	← 2 W →
Operating Collector Junction Temperature Range	-65°C to 150°C	
Storage Temperature Range	-65°C to 150°C	
Lead Temperature 1/8 Inch from Case for 10 Seconds	← 260°C →	

- NOTES: 1. These values apply when the base-emitter diode is open-circuited.
2. Derate linearly to 150°C case temperature at the rate of 0.32 W/deg.
3. Derate linearly to 150°C free-air temperature at the rate of 16 mW/deg.



TEXAS INSTRUMENTS
INCORPORATED
POST OFFICE BOX 5012 • DALLAS, TEXAS 75222

TYPES TIP32, TIP32A

P-N-P SINGLE-DIFFUSED SILICON POWER TRANSISTORS

electrical characteristics at 25°C case temperature

PARAMETER	TEST CONDITIONS	TIP32		TIP32A		UNIT
		MIN	MAX	MIN	MAX	
$V_{(BR)CEO}$ Collector-Emitter Breakdown Voltage	$I_C = -50 \text{ mA}$, $I_B = 0$, See Note 4	-40		-60		V
I_{CEO} Collector Cutoff Current	$V_{CE} = -30 \text{ V}$, $I_B = 0$		-0.5		-0.5	mA
I_{CES} Collector Cutoff Current	$V_{CE} = -40 \text{ V}$, $V_{BE} = 0$		-0.3			mA
	$V_{CE} = -60 \text{ V}$, $V_{BE} = 0$				-0.3	
I_{EBO} Emitter Cutoff Current	$V_{EB} = -5 \text{ V}$, $I_C = 0$		-1		-1	mA
h_{FE} Static Forward Current Transfer Ratio	$V_{CE} = -4 \text{ V}$, $I_C = -1 \text{ A}$, See Notes 4 and 5	20	100	20	100	
	$V_{CE} = -4 \text{ V}$, $I_C = -3 \text{ A}$, See Notes 4 and 5	8		8		
V_{BE} Base-Emitter Voltage	$V_{CE} = -4 \text{ V}$, $I_C = -1 \text{ A}$, See Notes 4 and 5		-1.3		-1.3	V
	$V_{CE} = -4 \text{ V}$, $I_C = -3 \text{ A}$, See Notes 4 and 5		-1.8		-1.8	
$V_{CE(sat)}$ Collector-Emitter Saturation Voltage	$I_B = -100 \text{ mA}$, $I_C = -1 \text{ A}$, See Notes 4 and 5		-0.6		-0.6	V
	$I_B = -375 \text{ mA}$, $I_C = -3 \text{ A}$, See Notes 4 and 5		-1.2		-1.2	
h_{fo} Small-Signal Common-Emitter Forward Current Transfer Ratio	$V_{CE} = -10 \text{ V}$, $I_C = -0.5 \text{ A}$, $f = 1 \text{ kHz}$	20		20		
$ h_{fe} $ Small-Signal Common-Emitter Forward Current Transfer Ratio	$V_{CE} = -10 \text{ V}$, $I_C = -0.5 \text{ A}$, $f = 1 \text{ MHz}$	3		3		

NOTES: 4. These parameters must be measured using pulse techniques. $t_p \leq 300 \mu\text{s}$, duty cycle $\leq 2\%$.

Pulse width must be such that halving or doubling does not cause a change greater than the required accuracy of the measurement.

5. These parameters are measured with voltage-sensing contacts separate from the current-carrying contacts.

thermal characteristics

PARAMETER	MAX	UNIT
θ_{J-C} Junction-to-Case Thermal Resistance	3.125	deg/W
θ_{J-A} Junction-to-Free-Air Thermal Resistance	62.5	

switching characteristics at 25°C case temperature

PARAMETER	TEST CONDITIONS†	TYP	UNIT
t_{on} Turn-On Time	$I_C = -1 \text{ A}$, $I_{B(1)} = -100 \text{ mA}$, $I_{B(2)} = 100 \text{ mA}$, $V_{BE(off)} = 3.7 \text{ V}$, $R_L = 20 \Omega$, See Figure 1	0.17	μs
t_{off} Turn-Off Time		0.5	

†Voltage and current values shown are nominal; exact values vary slightly with transistor parameters.

TYPES TIP32, TIP32A P-N-P SINGLE-DIFFUSED SILICON POWER TRANSISTORS

PARAMETER MEASUREMENT INFORMATION

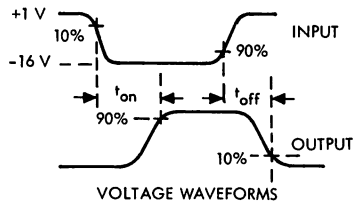
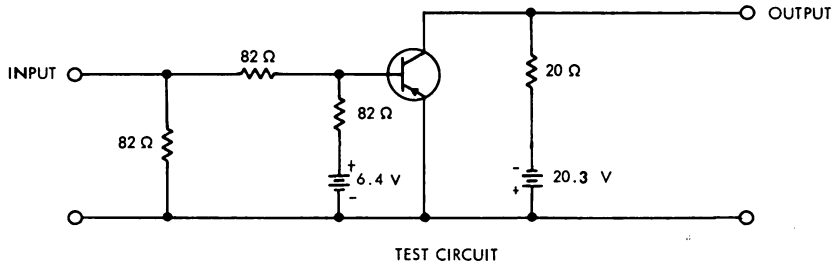

FIGURE 1

- NOTES:
- The input waveform is supplied by a generator with the following characteristics: $t_r \leq 15$ ns, $t_f \leq 15$ ns, $Z_{out} = 50 \Omega$, $t_p = 10 \mu$ s, duty cycle $\leq 2\%$.
 - Waveforms are monitored on an oscilloscope with the following characteristics: $t_r \leq 15$ ns, $R_{in} \geq 10$ M Ω , $C_{in} \leq 11.5$ pF.
 - Resistors must be noninductive types.
 - The d-c power supplies may require additional bypassing in order to minimize ringing.

MAXIMUM SAFE OPERATING REGION

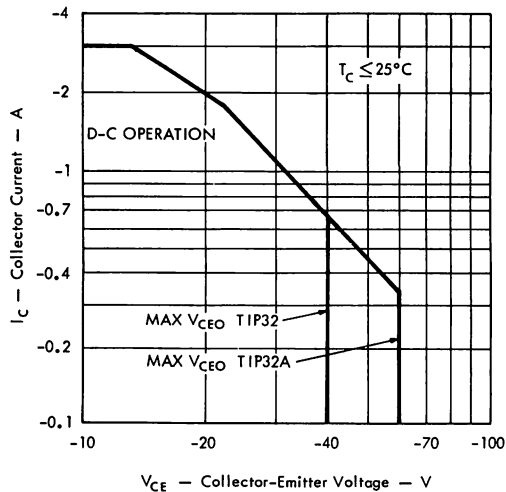

FIGURE 2

TYPES TIP32, TIP32A

P-N-P SINGLE-DIFFUSED SILICON POWER TRANSISTORS

TYPICAL CHARACTERISTICS

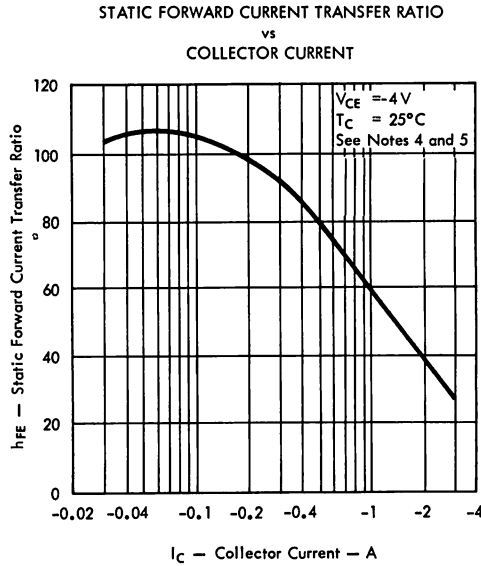

FIGURE 3

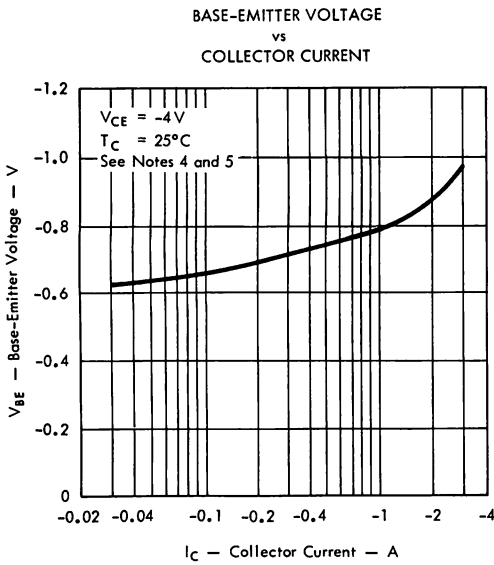

FIGURE 4

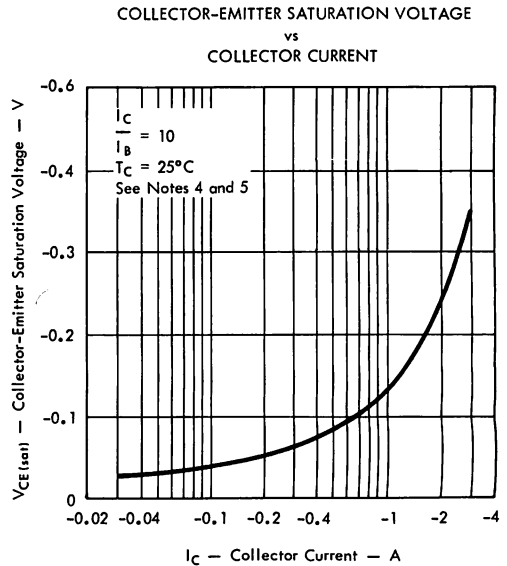

FIGURE 5

NOTES: 4. These parameters must be measured using pulse techniques. $t_p \leq 300 \mu s$, duty cycle $\leq 2\%$.

Pulse width must be such that halving or doubling does not cause a change greater than the required accuracy of the measurement.

5. These parameters are measured with voltage-sensing contacts separate from the current-carrying contacts.

TYPES TIP33, TIP33A N-P-N SINGLE-DIFFUSED SILICON POWER TRANSISTORS



FOR POWER-AMPLIFIER AND HIGH-SPEED-SWITCHING APPLICATIONS
DESIGNED FOR COMPLEMENTARY USE WITH TIP34, TIP34A

- 80 Watts at 25°C Case Temperature
- 10 A Rated Collector Current
- Min f_T of 3 MHz at 10 V, 500 mA

TYPES TIP33, TIP33A
BULLETIN NO. DLS-6810957, JULY 1968

mechanical data

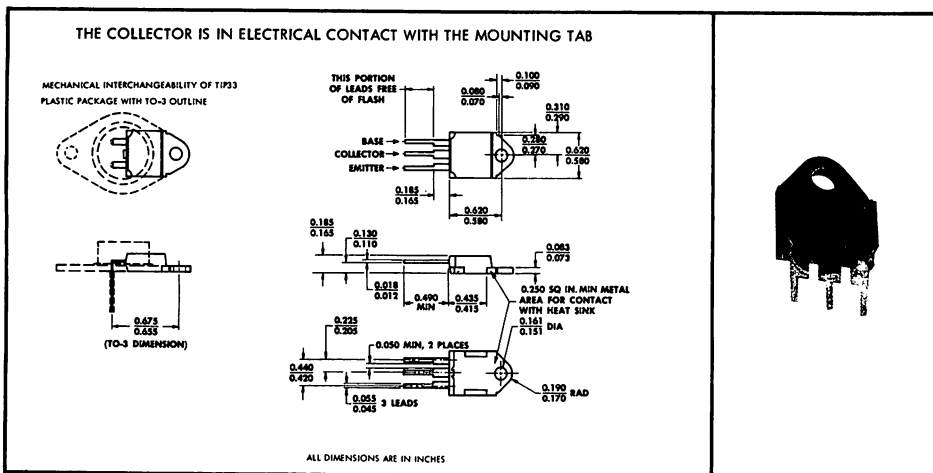

absolute maximum ratings at 25°C case temperature (unless otherwise noted)

	TIP33	TIP33A
Collector-Base Voltage	40 V	60 V
Collector-Emitter Voltage (See Note 1)	40 V	60 V
Emitter-Base Voltage	← 5 V →	
Continuous Collector Current	← 10 A →	
Continuous Base Current	← 3 A →	
Safe Operating Region at (or below) 25°C Case Temperature	See Figure 2	
Continuous Device Dissipation at (or below) 25°C Case Temperature (See Note 2)	← 80 W →	
Continuous Device Dissipation at (or below) 25°C Free-Air Temperature (See Note 3)	← 3.5 W →	
Operating Collector Junction Temperature Range	-65°C to 150°C	
Storage Temperature Range	-65°C to 150°C	
Lead Temperature 1/8 Inch from Case for 10 Seconds	← 260°C →	

- NOTES: 1. These values apply when the base-emitter diode is open-circuited.
2. Derate linearly to 150°C case temperature at the rate of 0.64 W/deg.
3. Derate linearly to 150°C free-air temperature at the rate of 28 mW/deg.



TEXAS INSTRUMENTS
INCORPORATED
POST OFFICE BOX 5012 • DALLAS, TEXAS 75222

TYPES TIP33, TIP33A

N-P-N SINGLE-DIFFUSED SILICON POWER TRANSISTORS

electrical characteristics at 25°C case temperature

PARAMETER	TEST CONDITIONS	TIP33		TIP33A		UNIT
		MIN	MAX	MIN	MAX	
$V_{(BR)CEO}$ Collector-Emitter Breakdown Voltage	$I_C = 200 \text{ mA}, I_B = 0$, See Note 4	40		60		V
I_{CEO} Collector Cutoff Current	$V_{CE} = 30 \text{ V}, I_B = 0$	0.7		0.7		mA
I_{CES} Collector Cutoff Current	$V_{CE} = 40 \text{ V}, V_{BE} = 0$	0.4				mA
	$V_{CE} = 60 \text{ V}, V_{BE} = 0$			0.4		
I_{EBO} Emitter Cutoff Current	$V_{EB} = 5 \text{ V}, I_C = 0$	1		1		mA
h_{FE} Static Forward Current Transfer Ratio	$V_{CE} = 4 \text{ V}, I_C = 1 \text{ A}$, See Notes 4 and 5	25	125	25	125	
	$V_{CE} = 4 \text{ V}, I_C = 3 \text{ A}$, See Notes 4 and 5	12		12		
	$V_{CE} = 4 \text{ V}, I_C = 10 \text{ A}$, See Notes 4 and 5	4		4		
V_{BE} Base-Emitter Voltage	$V_{CE} = 4 \text{ V}, I_C = 3 \text{ A}$, See Notes 4 and 5	1.6		1.6		V
	$V_{CE} = 4 \text{ V}, I_C = 10 \text{ A}$, See Notes 4 and 5	3		3		
$V_{CE(sat)}$ Collector-Emitter Saturation Voltage	$I_B = 300 \text{ mA}, I_C = 3 \text{ A}$, See Notes 4 and 5	1		1		V
	$I_B = 2.5 \text{ A}, I_C = 10 \text{ A}$, See Notes 4 and 5	4		4		
h_{fo} Small-Signal Common-Emitter Forward Current Transfer Ratio	$V_{CE} = 10 \text{ V}, I_C = 0.5 \text{ A}, f = 1 \text{ kHz}$	20		20		
$ h_{fo} $ Small-Signal Common-Emitter Forward Current Transfer Ratio	$V_{CE} = 10 \text{ V}, I_C = 0.5 \text{ A}, f = 1 \text{ MHz}$	3		3		

NOTES: 4. These parameters must be measured using pulse techniques. $t_p \leq 300 \mu\text{s}$, duty cycle $\leq 2\%$.

Pulse width must be such that halving or doubling does not cause a change greater than the required accuracy of the measurement.

5. These parameters are measured with voltage-sensing contacts separate from the current-carrying contacts.

thermal characteristics

PARAMETER	MAX	UNIT
θ_{J-C} Junction-to-Case Thermal Resistance	1.56	deg/W
θ_{J-A} Junction-to-Free-Air Thermal Resistance	35.7	

switching characteristics at 25°C case temperature

PARAMETER	TEST CONDITIONS†	TYP	UNIT
t_{on} Turn-On Time	$I_C = 1 \text{ A}, I_{B(1)} = 100 \text{ mA}, I_{B(2)} = -100 \text{ mA}$	0.45	μs
t_{off} Turn-Off Time	$V_{BE(off)} = -3.7 \text{ V}, R_L = 20 \Omega$, See Figure 1	0.35	

†Voltage and current values shown are nominal; exact values vary slightly with transistor parameters.

TYPES TIP33, TIP33A N-P-N SINGLE-DIFFUSED SILICON POWER TRANSISTORS

PARAMETER MEASUREMENT INFORMATION

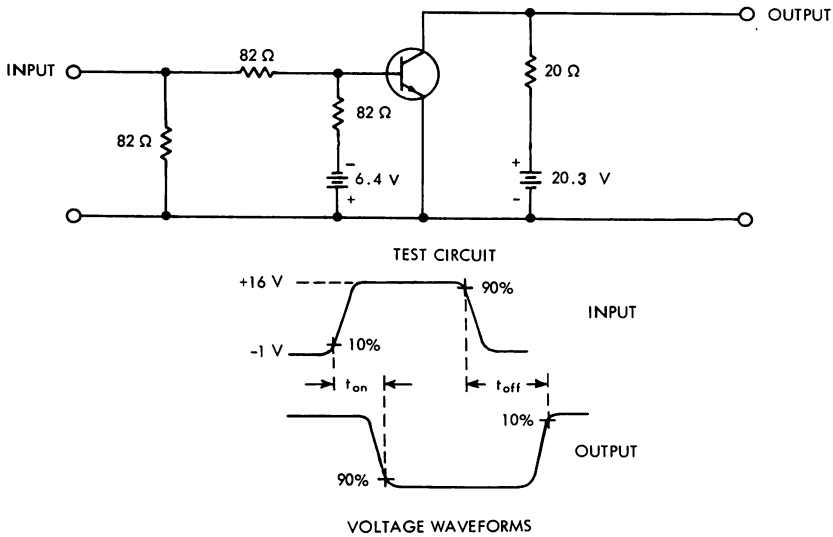

FIGURE 1

- NOTES:
- The input waveform is supplied by a generator with the following characteristics: $t_r \leq 15$ ns, $t_f \leq 15$ ns, $Z_{out} = 50 \Omega$, $t_p = 10 \mu$ s, duty cycle $\leq 2\%$.
 - Waveforms are monitored on an oscilloscope with the following characteristics: $t_r \leq 15$ ns, $R_{in} \geq 10$ M Ω , $C_{in} \leq 11.5$ pF.
 - Resistors must be noninductive types.
 - The d-c power supplies may require additional bypassing in order to minimize ringing.

MAXIMUM SAFE OPERATING REGION

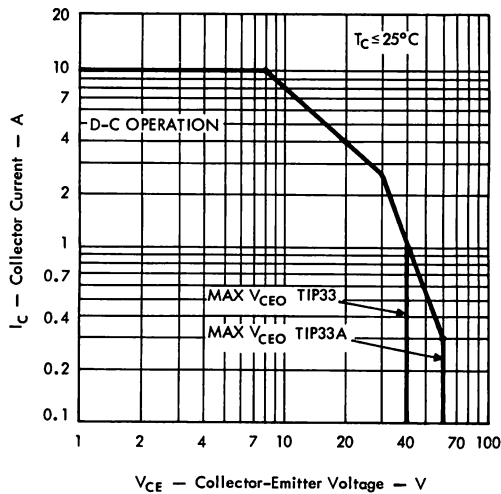

FIGURE 2

TYPES TIP33, TIP33A N-P-N SINGLE-DIFFUSED SILICON POWER TRANSISTORS

TYPICAL CHARACTERISTICS

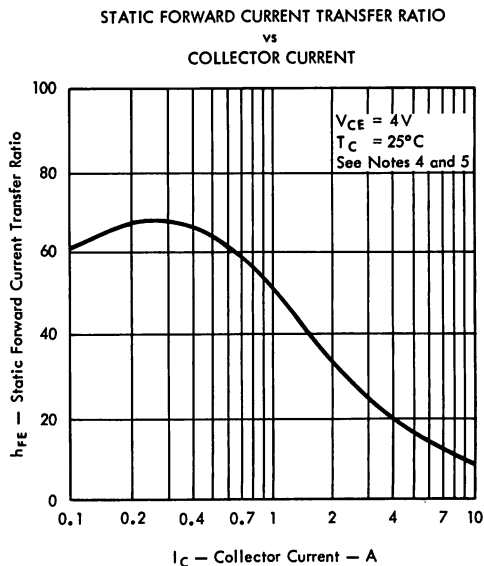

FIGURE 3

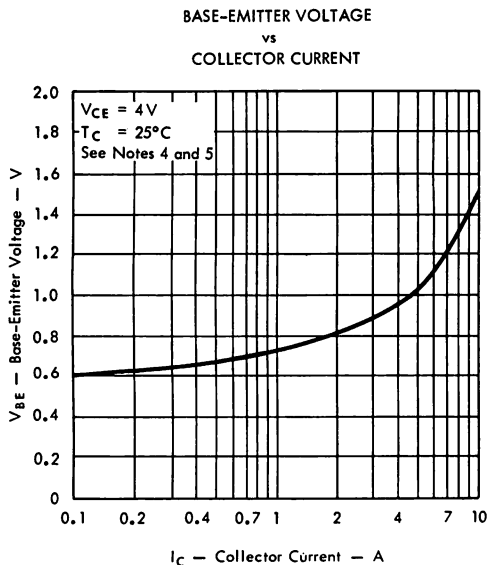

FIGURE 4

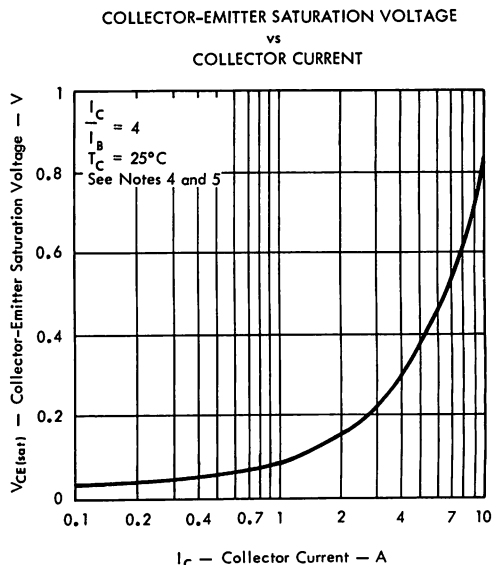

FIGURE 5

NOTES: 4. These parameters must be measured using pulse techniques. $t_p \leq 300 \mu s$, duty cycle $\leq 2\%$.

Pulse width must be such that halving or doubling does not cause a change greater than the required accuracy of the measurement.

5. These parameters are measured with voltage-sensing contacts separate from the current-carrying contacts.

TYPES TIP34, TIP34A P-N-P SINGLE-DIFFUSED SILICON POWER TRANSISTORS



TYPES TIP34, TIP34A
BULLETIN NO. DL-S 6810958, JULY 1968

**FOR POWER-AMPLIFIER AND HIGH-SPEED-SWITCHING APPLICATIONS
DESIGNED FOR COMPLEMENTARY USE WITH TIP33, TIP33A**

- 80 Watts at 25°C Case Temperature
- 10 A Rated Collector Current
- Min f_T of 3 MHz at 10 V, 500 mA

mechanical data

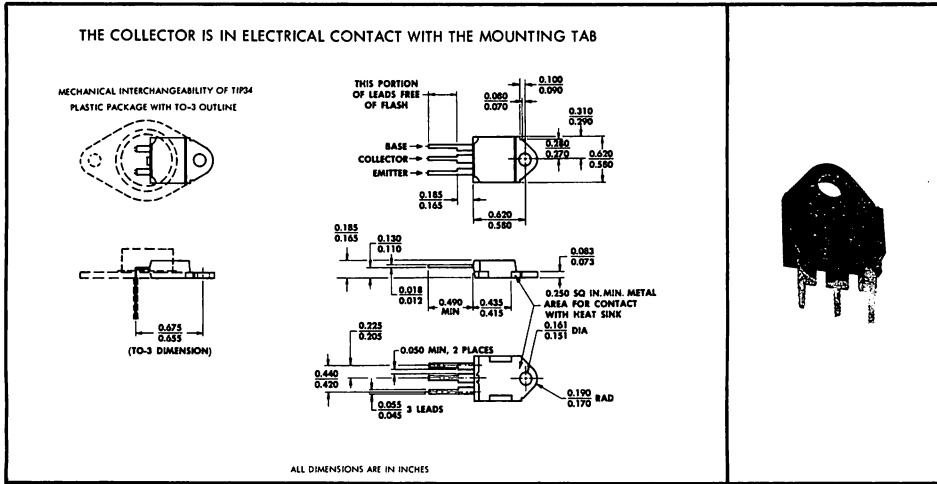

absolute maximum ratings at 25°C case temperature (unless otherwise noted)

	TIP34	TIP34A
Collector-Base Voltage	-40 V	-60 V
Collector-Emitter Voltage (See Note 1)	-40 V	-60 V
Emitter-Base Voltage	← -5 V →	
Continuous Collector Current	← -10 A →	
Continuous Base Current	← -3 A →	
Safe Operating Region at (or below) 25°C Case Temperature	See Figure 2	
Continuous Device Dissipation at (or below) 25°C Case Temperature (See Note 2)	← 80 W →	
Continuous Device Dissipation at (or below) 25°C Free-Air Temperature (See Note 3)	← 3.5 W →	
Operating Collector Junction Temperature Range	-65°C to 150°C	
Storage Temperature Range	-65°C to 150°C	
Lead Temperature 1/8 Inch from Case for 10 Seconds	← 260°C →	

- NOTES: 1. These values apply when the base-emitter diode is open-circuited.
 2. Derate linearly to 150°C case temperature at the rate of 0.64 W/deg.
 3. Derate linearly to 150°C free-air temperature at the rate of 28 mW/deg.

TYPES TIP34, TIP34A

P-N-P SINGLE-DIFFUSED SILICON POWER TRANSISTORS

electrical characteristics at 25°C case temperature

PARAMETER	TEST CONDITIONS	TIP34		TIP34A		UNIT
		MIN	MAX	MIN	MAX	
$V_{(BR)CEO}$ Collector-Emitter Breakdown Voltage	$I_C = -200 \text{ mA}$, $I_B = 0$, See Note 4	-40		-60		V
I_{CEO} Collector Cutoff Current	$V_{CE} = -30 \text{ V}$, $I_B = 0$	-0.7		-0.7		mA
I_{CES} Collector Cutoff Current	$V_{CE} = -40 \text{ V}$, $V_{BE} = 0$	-0.4				mA
	$V_{CE} = -60 \text{ V}$, $V_{BE} = 0$			-0.4		
I_{ERO} Emitter Cutoff Current	$V_{EB} = -5 \text{ V}$, $I_C = 0$		-1		-1	mA
h_{FE} Static Forward Current Transfer Ratio	$V_{CE} = -4 \text{ V}$, $I_C = -1 \text{ A}$, See Notes 4 and 5	25	125	25	125	
	$V_{CE} = -4 \text{ V}$, $I_C = -3 \text{ A}$, See Notes 4 and 5	12		12		
	$V_{CE} = -4 \text{ V}$, $I_C = -10 \text{ A}$, See Notes 4 and 5	4		4		
V_{BE} Base-Emitter Voltage	$V_{CE} = -4 \text{ V}$, $I_C = -3 \text{ A}$, See Notes 4 and 5		-1.6		-1.6	V
	$V_{CE} = -4 \text{ V}$, $I_C = -10 \text{ A}$, See Notes 4 and 5		-3		-3	
$V_{CE(sat)}$ Collector-Emitter Saturation Voltage	$I_B = -300 \text{ mA}$, $I_C = -3 \text{ A}$, See Notes 4 and 5		-1		-1	V
	$I_B = -2.5 \text{ A}$, $I_C = -10 \text{ A}$, See Notes 4 and 5		-4		-4	
h_{fo} Small-Signal Common-Emitter Forward Current Transfer Ratio	$V_{CE} = -10 \text{ V}$, $I_C = -0.5 \text{ A}$, $f = 1 \text{ kHz}$	20		20		
$ h_{fe} $ Small-Signal Common-Emitter Forward Current Transfer Ratio	$V_{CE} = -10 \text{ V}$, $I_C = -0.5 \text{ A}$, $f = 1 \text{ MHz}$	3		3		

NOTES: 4. These parameters must be measured using pulse techniques. $t_p \leq 300 \mu\text{s}$, duty cycle $\leq 2\%$. Pulse width must be such that halving or doubling does not cause a change greater than the required accuracy of the measurement.

5. These parameters are measured with voltage-sensing contacts separate from the current-carrying contacts

thermal characteristics

PARAMETER	MAX	UNIT
θ_{J-C} Junction-to-Case Thermal Resistance	1.56	deg/W
θ_{J-A} Junction-to-Free-Air Thermal Resistance	35.7	

switching characteristics at 25°C case temperature

PARAMETER	TEST CONDITIONS†	TYP	UNIT
t_{on} Turn-On Time	$I_C = -1 \text{ A}$, $I_B(1) = -100 \text{ mA}$, $I_B(2) = 100 \text{ mA}$, $V_{BE(off)} = 3.7 \text{ V}$, $R_L = 20 \Omega$, See Figure 1	0.35	μs
t_{off} Turn-Off Time		0.80	

†Voltage and current values shown are nominal; exact values vary slightly with transistor parameters.

TYPES TIP34, TIP34A P-N-P SINGLE-DIFFUSED SILICON POWER TRANSISTORS

PARAMETER MEASUREMENT INFORMATION

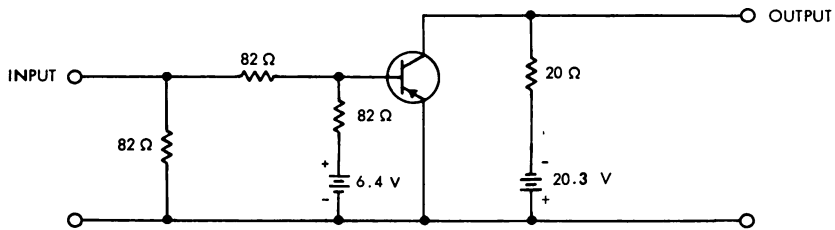

TEST CIRCUIT

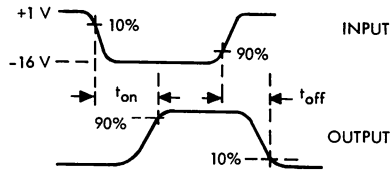

VOLTAGE WAVEFORMS

FIGURE 1

- NOTES:
- The input waveform is supplied by a generator with the following characteristics: $t_r \leq 15$ ns, $t_f \leq 15$ ns, $Z_{out} = 50 \Omega$, $t_p = 10 \mu$ s, duty cycle $\leq 2\%$.
 - Waveforms are monitored on an oscilloscope with the following characteristics: $t_r \leq 15$ ns, $R_{in} \geq 10$ M Ω , $C_{in} \leq 11.5$ pF.
 - Resistors must be noninductive types.
 - The d-c power supplies may require additional bypassing in order to minimize ringing.

MAXIMUM SAFE OPERATING REGION

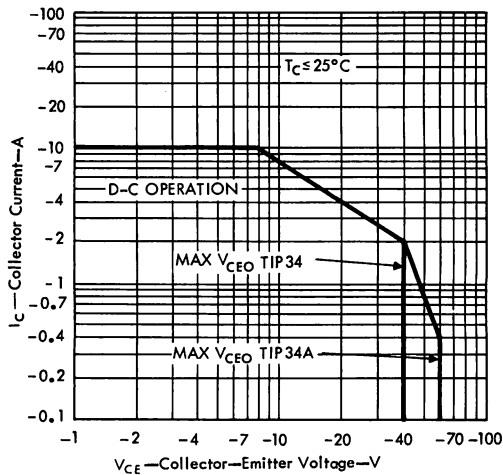
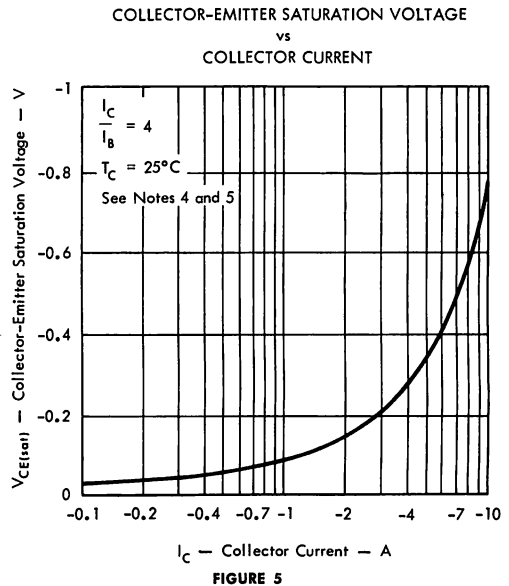
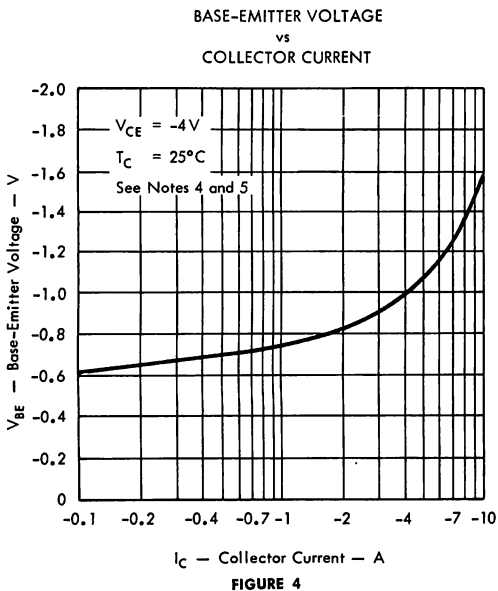
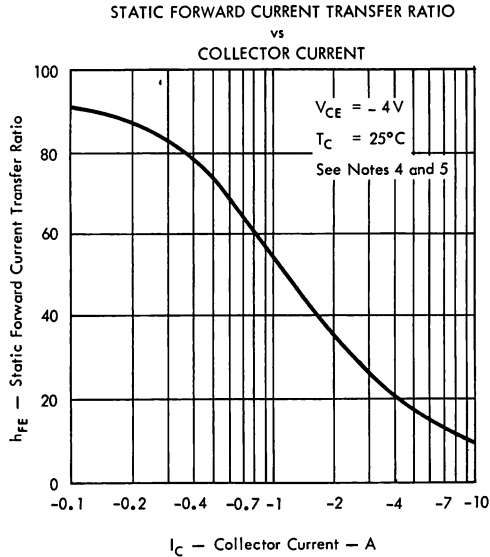

FIGURE 2

TYPES TIP34, TIP34A

P-N-P SINGLE-DIFFUSED SILICON POWER TRANSISTORS

TYPICAL CHARACTERISTICS



- NOTES:
4. These parameters must be measured using pulse techniques. $t_p \leq 300 \mu s$, duty cycle $\leq 2\%$. Pulse width must be such that halving or doubling does not cause a change greater than the required accuracy of the measurement.
 5. These parameters are measured with voltage-sensing contacts separate from the current-carrying contacts.

TYPES TIP35, TIP35A N-P-N SINGLE-DIFFUSED SILICON POWER TRANSISTORS



TYPES TIP35, TIP35A
BULLETIN NO. DL-5 6810959, JULY 1968

**FOR POWER-AMPLIFIER AND HIGH-SPEED-SWITCHING APPLICATIONS
DESIGNED FOR COMPLEMENTARY USE WITH TIP36, TIP36A**

- 90 Watts at 25°C Case Temperature
- 25 A Rated Collector Current
- Min f_T of 3 MHz at 10 V, 1 A

mechanical data

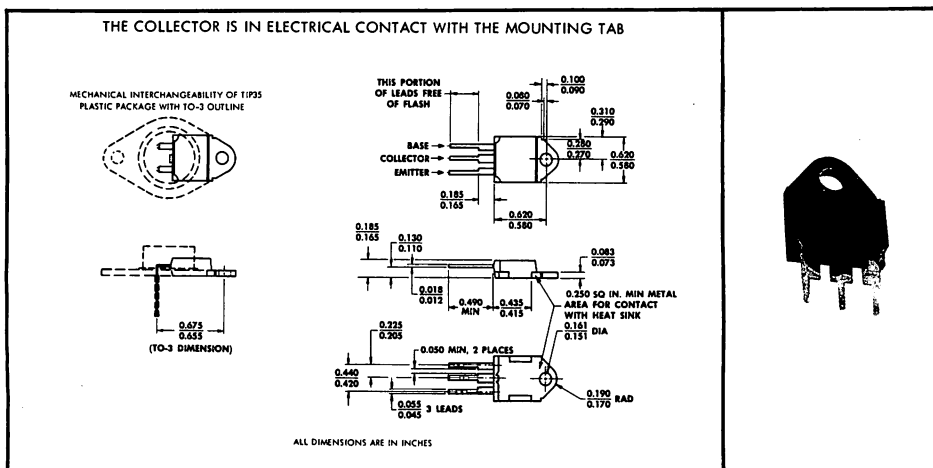

absolute maximum ratings at 25°C case temperature (unless otherwise noted)

	TIP35	TIP35A
Collector-Base Voltage	40 V	60 V
Collector-Emitter Voltage (See Note 1)	40 V	60 V
Emitter-Base Voltage	← 5 V →	← 5 V →
Continuous Collector Current	← 25 A →	← 25 A →
Continuous Base Current	← 5 A →	← 5 A →
Safe Operating Region at (or below) 25°C Case Temperature	See Figure 2	
Continuous Device Dissipation at (or below) 25°C Case Temperature (See Note 2)	← 90 W →	← 90 W →
Continuous Device Dissipation at (or below) 25°C Free-Air Temperature (See Note 3)	← 3.5 W →	← 3.5 W →
Operating Collector Junction Temperature Range	-65°C to 150°C	
Storage Temperature Range	-65°C to 150°C	
Lead Temperature 1/8 Inch from Case for 10 Seconds	← 260°C →	

NOTES: 1. These values apply when the base-emitter diode is open-circuited.
 2. Derate linearly to 150°C case temperature at the rate of 0.72 W/deg.
 3. Derate linearly to 150°C free-air temperature at the rate of 28 mW/deg.



TEXAS INSTRUMENTS
INCORPORATED
POST OFFICE BOX 5012 • DALLAS, TEXAS 75222

TYPES TIP35, TIP35A

N-P-N SINGLE-DIFFUSED SILICON POWER TRANSISTORS

electrical characteristics at 25°C case temperature

PARAMETER	TEST CONDITIONS	TIP35		TIP35A		UNIT
		MIN	MAX	MIN	MAX	
$V_{(BR)CEO}$ Collector-Emitter Breakdown Voltage	$I_C = 200 \text{ mA}$, $I_B = 0$, See Note 4	40		60		V
I_{CEO} Collector Cutoff Current	$V_{CE} = 30 \text{ V}$, $I_B = 0$		1		1	mA
I_{CES} Collector Cutoff Current	$V_{CE} = 40 \text{ V}$, $V_{BE} = 0$		0.7			mA
	$V_{CE} = 60 \text{ V}$, $V_{BE} = 0$				0.7	
I_{EBO} Emitter Cutoff Current	$V_{EB} = 5 \text{ V}$, $I_C = 0$		1		1	mA
h_{FE} Static Forward Current Transfer Ratio	$V_{CE} = 4 \text{ V}$, $I_C = 5 \text{ A}$, See Notes 4 and 5	20	100	20	100	
	$V_{CE} = 4 \text{ V}$, $I_C = 15 \text{ A}$, See Notes 4 and 5	10		10		
	$V_{CE} = 4 \text{ V}$, $I_C = 25 \text{ A}$, See Notes 4 and 5	5		5		
V_{BE} Base-Emitter Voltage	$V_{CE} = 4 \text{ V}$, $I_C = 15 \text{ A}$, See Notes 4 and 5		2		2	V
	$V_{CE} = 4 \text{ V}$, $I_C = 25 \text{ A}$, See Notes 4 and 5		4		4	
$V_{CE(sat)}$ Collector-Emitter Saturation Voltage	$I_B = 1.5 \text{ A}$, $I_C = 15 \text{ A}$, See Notes 4 and 5		1.8		1.8	V
	$I_B = 5 \text{ A}$, $I_C = 25 \text{ A}$, See Notes 4 and 5		4		4	
h_{fo} Small-Signal Common-Emitter Forward Current Transfer Ratio	$V_{CE} = 10 \text{ V}$, $I_C = 1 \text{ A}$, $f = 1 \text{ kHz}$		25		25	
$ h_{fo} $ Small-Signal Common-Emitter Forward Current Transfer Ratio	$V_{CE} = 10 \text{ V}$, $I_C = 1 \text{ A}$, $f = 1 \text{ MHz}$		3		3	

NOTES: 4. These parameters must be measured using pulse techniques. $t_p \leq 300 \mu\text{s}$, duty cycle $\leq 2\%$.

Pulse width must be such that halving or doubling does not cause a change greater than the required accuracy of the measurement.

5. These parameters are measured with voltage-sensing contacts separate from the current-carrying contacts.

thermal characteristics

PARAMETER	MAX	UNIT
θ_{J-C} Junction-to-Case Thermal Resistance	1.39	deg/W
θ_{J-A} Junction-to-Free-Air Thermal Resistance	35.7	

switching characteristics at 25°C case temperature

PARAMETER	TEST CONDITIONS†	TYP	UNIT
t_{on} Turn-On Time	$I_C = 5 \text{ A}$, $I_{B(1)} = 500 \text{ mA}$, $I_{B(2)} = -500 \text{ mA}$, $V_{BE(off)} = -5 \text{ V}$, $R_L = 5 \Omega$, See Figure 1	0.6	μs
t_{off} Turn-Off Time		0.8	

†Voltage and current values shown are nominal; exact values vary slightly with transistor parameters.

TYPES TIP35, TIP35A N-P-N SINGLE-DIFFUSED SILICON POWER TRANSISTORS

PARAMETER MEASUREMENT INFORMATION

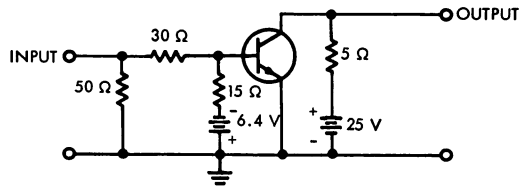

TEST CIRCUIT

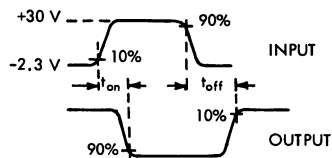

VOLTAGE WAVEFORMS

FIGURE 1

- NOTES: a. The input waveform is supplied by a generator with the following characteristics: $t_r \leq 15$ ns, $t_f \leq 15$ ns, $Z_{out} = 50 \Omega$, $t_p = 5 \mu$ s, duty cycle $\leq 2\%$.
 b. Waveforms are monitored on an oscilloscope with the following characteristics: $t_r \leq 15$ ns, $R_{in} \geq 10$ M Ω , $C_{in} \leq 11.5$ pF.
 c. Resistors must be noninductive types.
 d. The d-c power supplies may require additional bypassing in order to minimize ringing.

MAXIMUM SAFE OPERATING REGION

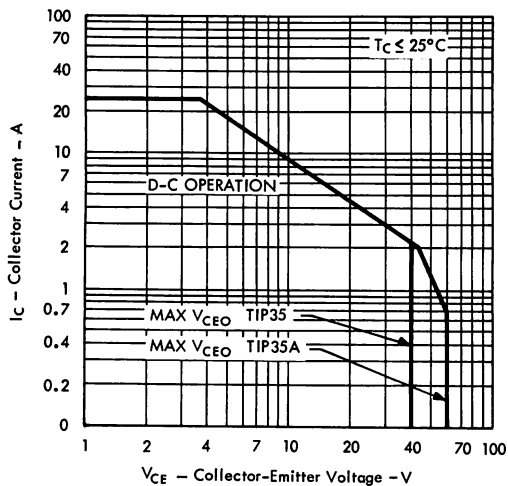

FIGURE 2

TYPES TIP35, TIP35A

N-P-N SINGLE-DIFFUSED SILICON POWER TRANSISTORS

TYPICAL CHARACTERISTICS

STATIC FORWARD CURRENT TRANSFER RATIO
vs
COLLECTOR CURRENT

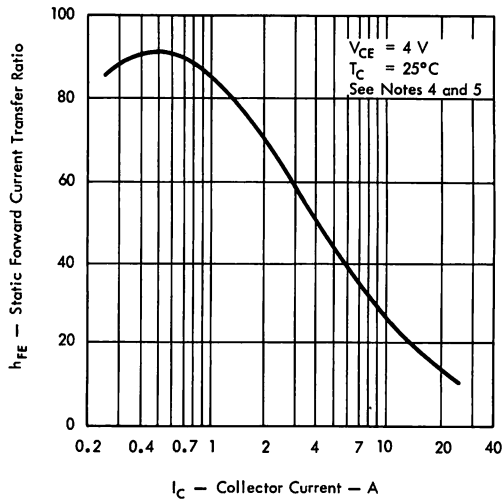

FIGURE 3

BASE-EMITTER VOLTAGE
vs
COLLECTOR CURRENT

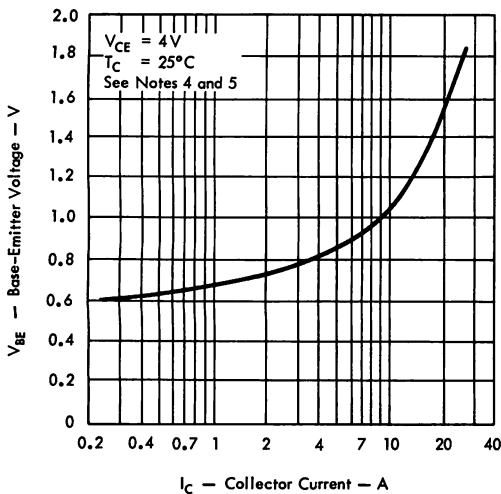

FIGURE 4

COLLECTOR-EMITTER SATURATION VOLTAGE
vs
COLLECTOR CURRENT

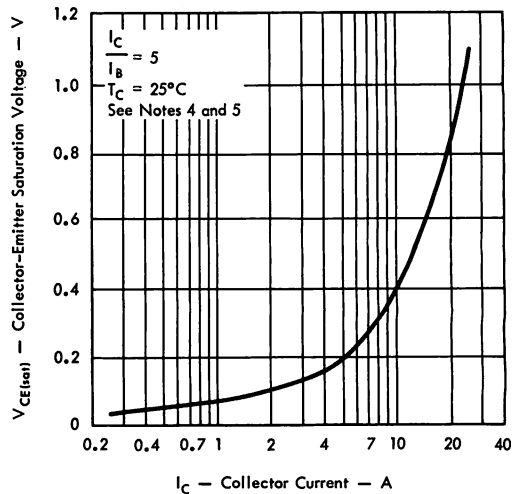

FIGURE 5

NOTES: 4. These parameters must be measured using pulse techniques. $t_p \leq 300\ \mu\text{s}$, duty cycle $\leq 2\%$.

Pulse width must be such that halving or doubling does not cause a change greater than the required accuracy of the measurement.

5. These parameters are measured with voltage-sensing contacts separate from the current-carrying contacts.

TYPES TIP36, TIP36A P-N-P SINGLE-DIFFUSED SILICON POWER TRANSISTORS



TYPES TIP36, TIP36A
BULLETIN NO. DL-5-6810955, JULY 1968

**FOR POWER-AMPLIFIER AND HIGH-SPEED-SWITCHING APPLICATIONS
DESIGNED FOR COMPLEMENTARY USE WITH TIP35, TIP35A**

- 90 Watts at 25°C Case Temperature
- 25 A Rated Collector Current
- Min f_T of 3 MHz at 10 V, 1 A

mechanical data

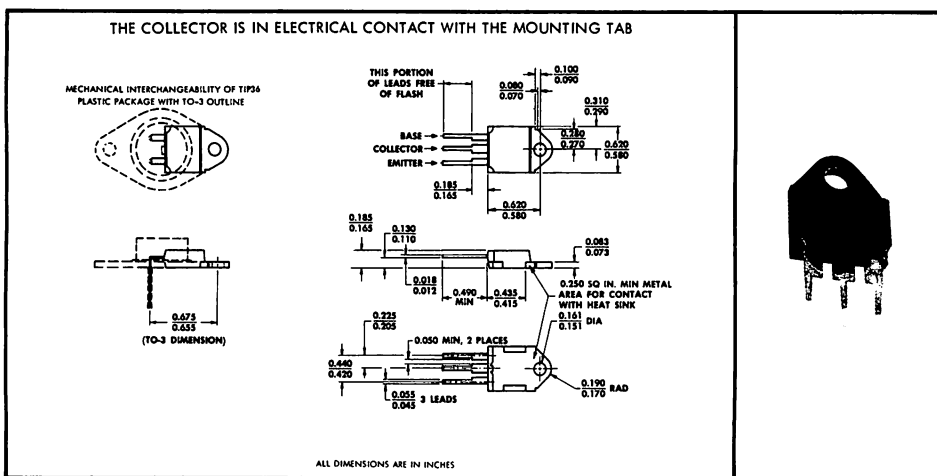

absolute maximum ratings at 25°C case temperature (unless otherwise noted)

	TIP36	TIP36A
Collector-Base Voltage	-40 V	-60 V
Collector-Emitter Voltage (See Note 1)	-40 V	-60 V
Emitter-Base Voltage	← -5 V →	← -5 V →
Continuous Collector Current	← -25 A →	← -25 A →
Continuous Base Current	← -5 A →	← -5 A →
Safe Operating Region at (or below) 25°C Case Temperature	See Figure 2	
Continuous Device Dissipation at (or below) 25°C Case Temperature (See Note 2)	← 90 W →	← 90 W →
Continuous Device Dissipation at (or below) 25°C Free-Air Temperature (See Note 3)	← 3.5 W →	← 3.5 W →
Operating Collector Junction Temperature Range	-65°C to 150°C	
Storage Temperature Range	-65°C to 150°C	
Lead Temperature 1/8 Inch from Case for 10 Seconds	← 260°C →	

- NOTES: 1. These values apply when the base-emitter diode is open-circuited.
 2. Derate linearly to 150°C case temperature at the rate of 0.72 W/deg.
 3. Derate linearly to 150°C free-air temperature at the rate of 28 mW/deg.



TYPES TIP36, TIP36A

P-N-P SINGLE-DIFFUSED SILICON POWER TRANSISTORS

electrical characteristics at 25°C case temperature

PARAMETER	TEST CONDITIONS	TIP36		TIP36A		UNIT
		MIN	MAX	MIN	MAX	
$V_{(BR)CEO}$ Collector-Emitter Breakdown Voltage	$I_C = -200 \text{ mA}, I_B = 0$, See Note 4	-40		-60		V
I_{CEO} Collector Cutoff Current	$V_{CE} = -30 \text{ V}, I_B = 0$		-1		-1	mA
I_{CES} Collector Cutoff Current	$V_{CE} = -40 \text{ V}, V_{BE} = 0$		-0.7			
	$V_{CE} = -60 \text{ V}, V_{BE} = 0$				-0.7	
I_{EBO} Emitter Cutoff Current	$V_{EB} = -5 \text{ V}, I_C = 0$		-1		-1	mA
h_{FE} Static Forward Current Transfer Ratio	$V_{CE} = -4 \text{ V}, I_C = -5 \text{ A}$, See Notes 4 and 5	20	100	20	100	
	$V_{CE} = -4 \text{ V}, I_C = -15 \text{ A}$, See Notes 4 and 5	10		10		
	$V_{CE} = -4 \text{ V}, I_C = -25 \text{ A}$, See Notes 4 and 5	5		5		
V_{BE} Base-Emitter Voltage	$V_{CE} = -4 \text{ V}, I_C = -15 \text{ A}$, See Notes 4 and 5		-2		-2	V
	$V_{CE} = -4 \text{ V}, I_C = -25 \text{ A}$, See Notes 4 and 5		-4		-4	
$V_{CE(sat)}$ Collector-Emitter Saturation Voltage	$I_B = -1.5 \text{ A}, I_C = -15 \text{ A}$, See Notes 4 and 5		-1.8		-1.8	V
	$I_B = -5 \text{ A}, I_C = -25 \text{ A}$, See Notes 4 and 5		-4		-4	
h_{fo} Small-Signal Common-Emitter Forward Current Transfer Ratio	$V_{CE} = -10 \text{ V}, I_C = -1 \text{ A}, f = 1 \text{ kHz}$	25		25		
$ h_{fo} $ Small-Signal Common-Emitter Forward Current Transfer Ratio	$V_{CE} = -10 \text{ V}, I_C = -1 \text{ A}, f = 1 \text{ MHz}$	3		3		

NOTES: 4. These parameters must be measured using pulse techniques. $t_p \leq 300 \mu\text{s}$, duty cycle $\leq 2\%$.

Pulse width must be such that halving or doubling does not cause a change greater than the required accuracy of the measurement.

5. These parameters are measured with voltage-sensing contacts separate from the current-carrying contacts.

thermal characteristics

PARAMETER	MAX	UNIT
θ_{J-C} Junction-to-Case Thermal Resistance	1.39	deg/W
θ_{J-A} Junction-to-Free-Air Thermal Resistance	35.7	

switching characteristics at 25°C case temperature

PARAMETER	TEST CONDITIONS†	TYP	UNIT
t_{on} Turn-On Time	$I_C = -5 \text{ A}, I_{B(1)} = -500 \text{ mA}, I_{B(2)} = 500 \text{ mA}, V_{BE(off)} = 5 \text{ V}, R_L = 5 \Omega$, See Figure 1	0.45	μs
t_{off} Turn-Off Time		0.55	

†Voltage and current values shown are nominal; exact values vary slightly with transistor parameters.

TYPES TIP36, TIP36A P-N-P SINGLE-DIFFUSED SILICON POWER TRANSISTORS

PARAMETER MEASUREMENT INFORMATION

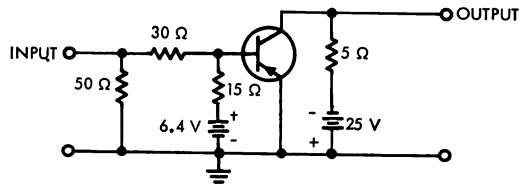

TEST CIRCUIT

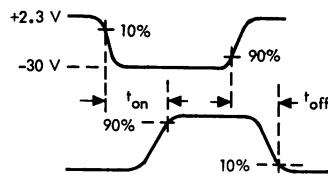

VOLTAGE WAVEFORMS

FIGURE 1

- NOTES: a. The input waveform is supplied by a generator with the following characteristics: $t_r \leq 15$ ns, $t_f \leq 15$ ns, $Z_{out} = 50 \Omega$, $t_p = 10 \mu$ s, duty cycle $\leq 2\%$.
 b. Waveforms are monitored on an oscilloscope with the following characteristics: $t_r \leq 15$ ns, $R_{in} \geq 10$ M Ω , $C_{in} \leq 11.5$ pF.
 c. Resistors must be noninductive types.
 d. The d-c power supplies may require additional bypassing in order to minimize ringing.

MAXIMUM SAFE OPERATING REGION

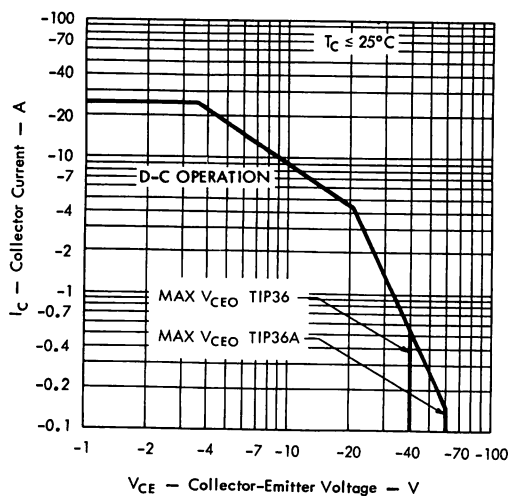

FIGURE 2

TYPES TIP36, TIP36A

P-N-P SINGLE-DIFFUSED SILICON POWER TRANSISTORS

TYPICAL CHARACTERISTICS

STATIC FORWARD CURRENT TRANSFER RATIO
vs
COLLECTOR CURRENT

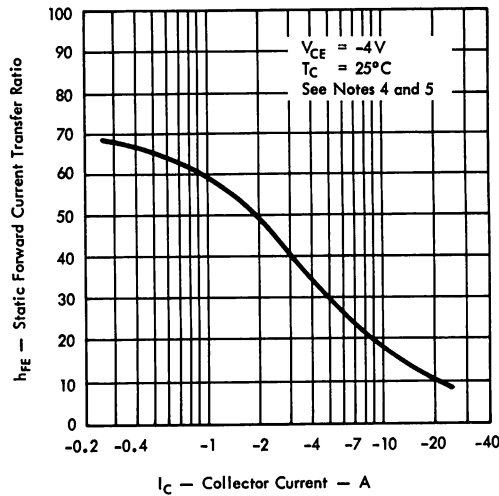

FIGURE 3

BASE-EMITTER VOLTAGE
vs
COLLECTOR CURRENT

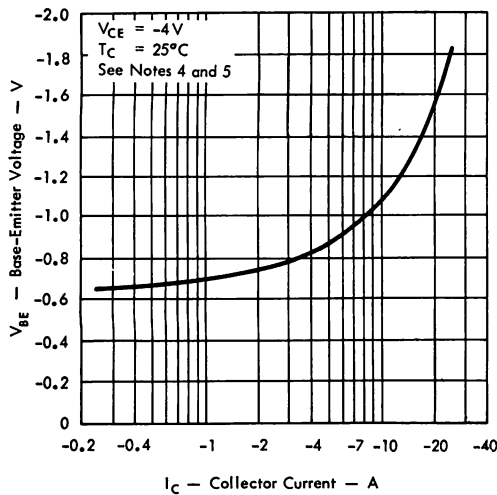

FIGURE 4

COLLECTOR-EMITTER SATURATION VOLTAGE
vs
COLLECTOR CURRENT

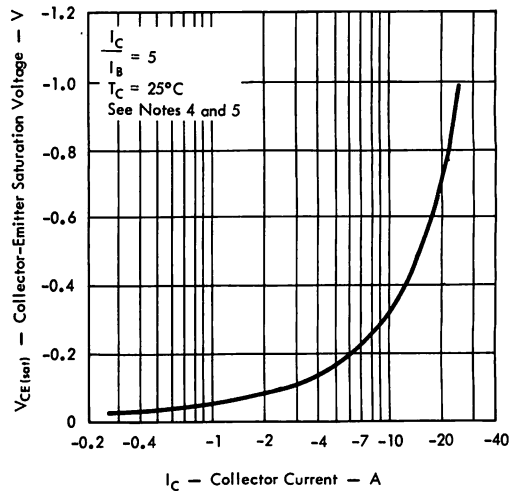

FIGURE 5

- NOTES: 4. These parameters must be measured using pulse techniques. $I_p \leq 300 \mu s$, duty cycle $\leq 2\%$.
Pulse width must be such that halving or doubling does not cause a change greater than the required accuracy of the measurement.
5. These parameters are measured with voltage-sensing contacts separate from the current-carrying contacts.

TYPES 2N1722, 2N1724 N-P-N TRIPLE-DIFFUSED MESA SILICON TRANSISTORS



TYPES 2N1722, 2N1724
BULLETIN NO. DL-S-611315, APRIL, 1961
REPLACES BULLETIN NO. DL-S-61431, MARCH 1961

HIGH-FREQUENCY POWER TRANSISTORS

- 50 Watts at 100°C Case Temperature
- Minimum f_T of 10 Megacycles
- Maximum R_{CS} of 0.5 Ohm at 2 Amperes I_C
- Maximum V_{BE} of 2 Volts at 2 Amperes I_C

mechanical data

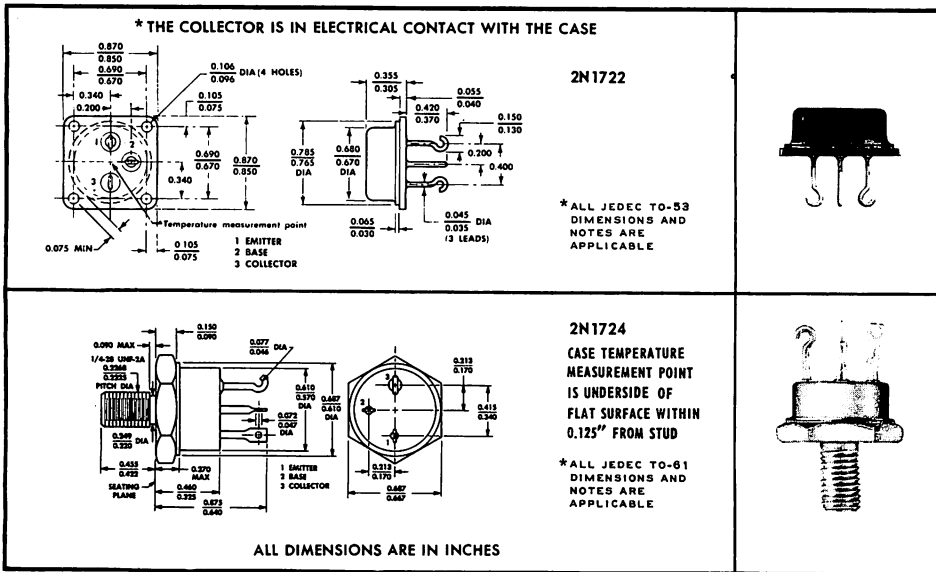

absolute maximum ratings at 25°C ambient temperature (unless otherwise noted)

Collector-Emitter Voltage (See Note 1)	80 v
Emitter-Base Voltage	10 v
Collector Current, Continuous	5 a
Collector Current, Peak (See Note 2)	7.5 a
Total Device Dissipation at 100°C Case Temperature (See Note 3)	50 w
Total Device Dissipation at 25°C Ambient Temperature (See Note 4)	3 w
Collector Junction Operating Temperature	+ 175°C
Storage Temperature Range	- 65°C to + 200°C

Note 1 This is the voltage at which $|h_{FE}|$ approaches one when the emitter-base diode is open-circuited. Maximum allowable collector-emitter voltage shall be derated with increasing collector current as shown in the maximum V_{CE} curve which appears with the collector characteristics. Average power dissipation shall not exceed the maximum ratings for this device.

Note 2 Maximum peak collector current may be allowed if maximum junction temperature is not exceeded. See Figure 2, "Junction Temperature Response vs Pulse Width and Duty Cycle."

Note 3 Derate linearly to 175°C case temperature at the rate of 0.67 w/C°.

Note 4 Derate linearly to 175°C ambient temperature at the rate of 20 mw/C°.

Note 5 For correct measurement of I_{CES} , the base must be shorted to the emitter. The current meter must not be placed in the base-emitter short-circuit loop. I_{CES} may be used in place of I_{CBO} for circuit-stability calculations.

Note 6 For typical BV_{CEB} at finite values of R_{BE} , refer to BV_{CEB} vs R_{BE} curve. Peak collector-emitter voltage of 120 v may be allowed in the cutoff-current region if the emitter-base diode is short-circuited.

Note 7 Heat-sinking sufficient to limit case temperature to 40°C or less over a 10-second measurement period must be used for this test.

Note 8 DC collector current should not be applied longer than 5 seconds to maintain case temperature less than 40°C without a heat sink.

Note 9 To obtain f_T , the $|h_{FE}|$ response with frequency is extrapolated at 6 db/octave to $|h_{FE}| = 1$ from $f = 10$ mc. The product of $f_T \times 1$ has been referred to as the gain-bandwidth product.



TEXAS INSTRUMENTS
INCORPORATED
POST OFFICE BOX 5012 • DALLAS, TEXAS 75222

TYPES 2N1722, 2N1724

N-P-N TRIPLE-DIFFUSED MESA SILICON TRANSISTORS

electrical characteristics at 25°C ambient temperature (unless otherwise noted)

Parameter		Test Conditions	Min.	Max.	Unit
I_{CES}	Collector Reverse Current	$V_{CE} = 60 \text{ v}, V_{BE} = 0$ (See note 5)		1	ma
I_{CES}	Collector Reverse Current	$V_{CE} = 60 \text{ v}, V_{BE} = 0,$ $T_C = +150^\circ\text{C}$ (See note 5)		2	ma
I_{CES}	Collector Reverse Current	$V_{CE} = 120 \text{ v}, V_{BE} = 0,$ $T_C = +150^\circ\text{C}$ (See note 5)		10	ma
I_{EBO}	Emitter Reverse Current	$V_{EB} = 10 \text{ v}, I_C = 0$		10	ma
* BV_{CEO}	Collector-Emitter Breakdown Voltage	$I_C = 200 \text{ ma}, I_B = 0$ (See notes 6 & 7)	80		v
* h_{FE}	DC Forward Current Transfer Ratio	$V_{CE} = 15 \text{ v}, I_C = 2 \text{ a}$	20	90	
* h_{FE}	DC Forward Current Transfer Ratio	$V_{CE} = 15 \text{ v}, I_C = 2 \text{ a},$ $T_A = -55^\circ\text{C}$	12		
* h_{FE}	DC Forward Current Transfer Ratio	$V_{CE} = 15 \text{ v}, I_C = 100 \text{ ma}$	20		
* V_{BE}	Base-Emitter Voltage	$I_B = 200 \text{ ma}, I_C = 2 \text{ a}$		2.0	v
* $V_{CE(sat)}$	Collector-Emitter Saturation Voltage	$I_B = 200 \text{ ma}, I_C = 2 \text{ a}$		1.0	v
$ h_{re} $	AC Common-Emitter Forward Current Transfer Ratio	$V_{CE} = 15 \text{ v}, I_C = 500 \text{ ma},$ $f = 10 \text{ mc}$ (See note 8)	1.0		
C_{ob}	Common-Base Output Capacitance	$V_{CB} = 15 \text{ v}, I_E = 0, f = 1 \text{ mc}$		550	pf

Thermal Characteristics

θ_{J-C}	Thermal Resistance, Junction to Case (Bottom, Center of Case)	1.5	$^\circ\text{C}/\text{w}$
----------------	---	-----	---------------------------

*Semi-automatic testing is facilitated by using pulse techniques to measure these parameters. A 300 μsec pulse (approximately 2% duty cycle) is utilized.

TYPICAL CHARACTERISTICS

COMMON-EMITTER COLLECTOR CHARACTERISTICS

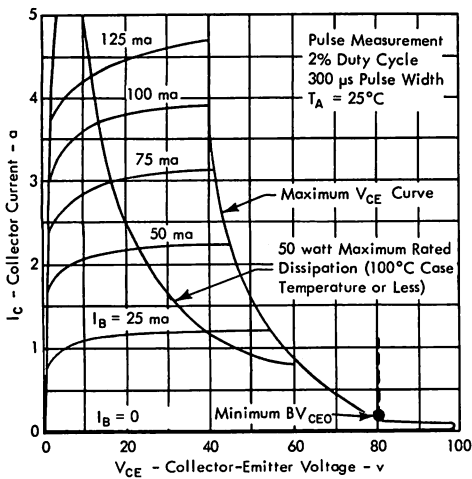

COMMON-EMITTER COLLECTOR CHARACTERISTICS (Low - Voltage)

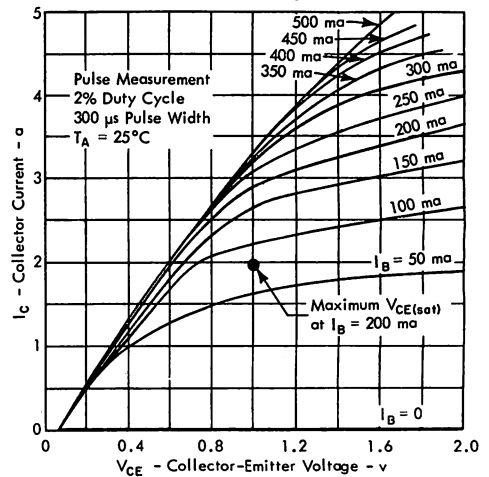

TYPES 2N1722, 2N1724 N-P-N TRIPLE-DIFFUSED MESA SILICON TRANSISTORS

TYPICAL CHARACTERISTICS

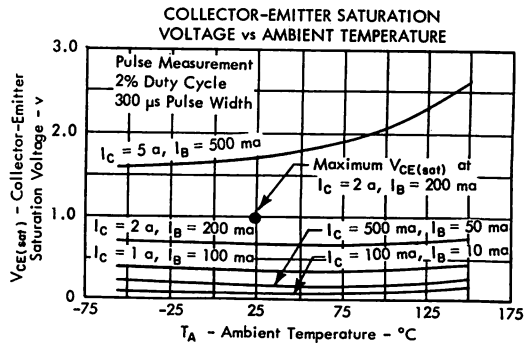
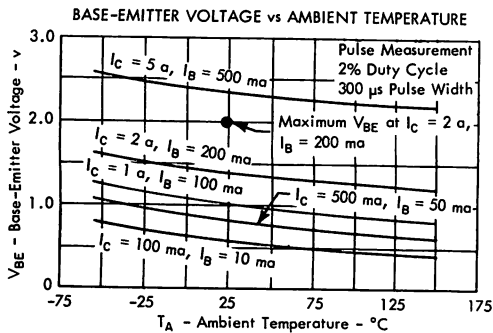
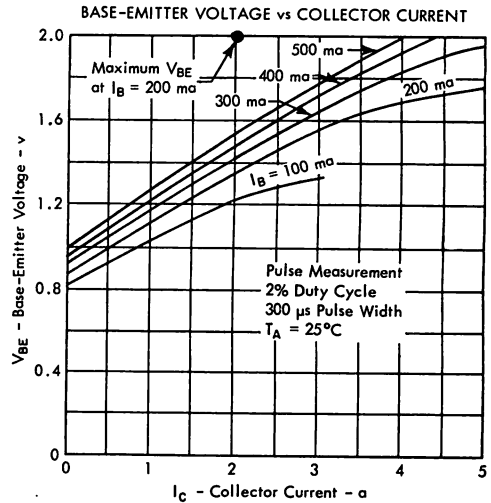
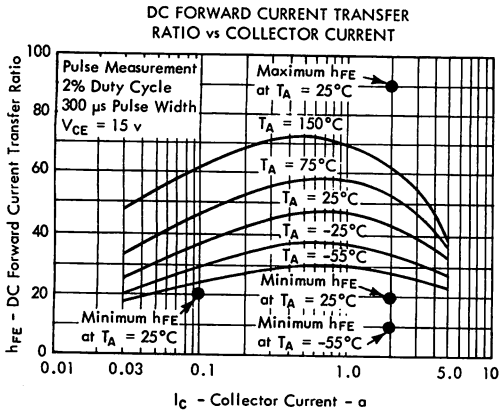

TYPES 2N1722, 2N1724

N-P-N TRIPLE-DIFFUSED MESA SILICON TRANSISTORS

TYPICAL CHARACTERISTICS

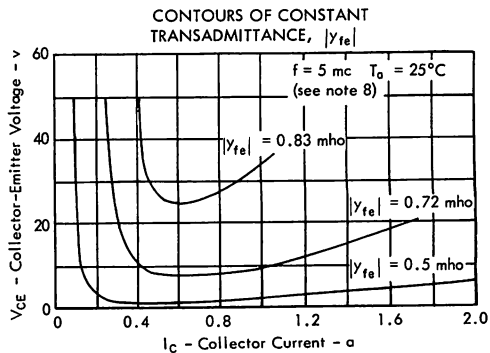
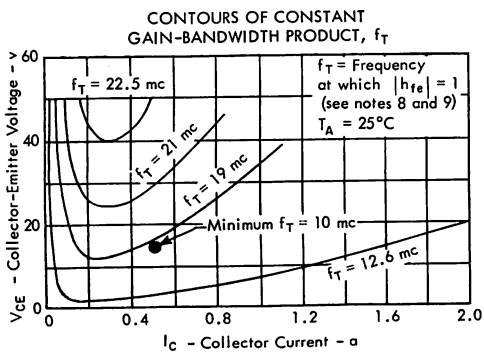
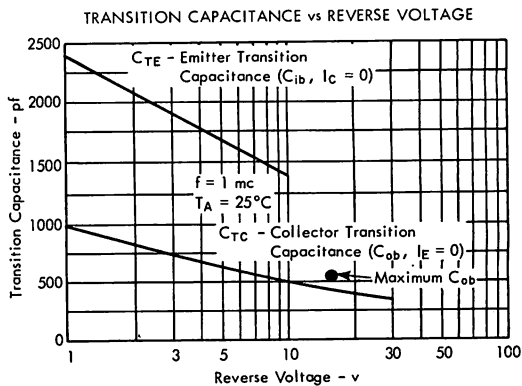
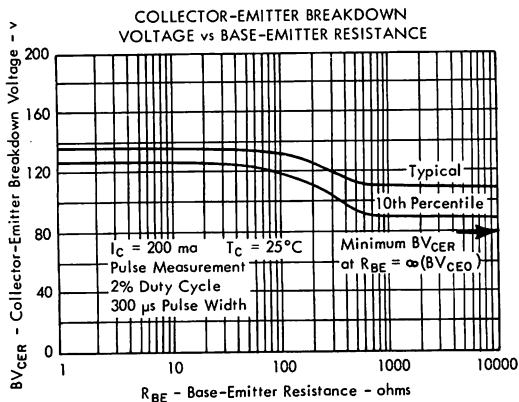

TYPES 2N1722, 2N1724 N-P-N TRIPLE-DIFFUSED MESA SILICON TRANSISTORS

TYPICAL CHARACTERISTICS

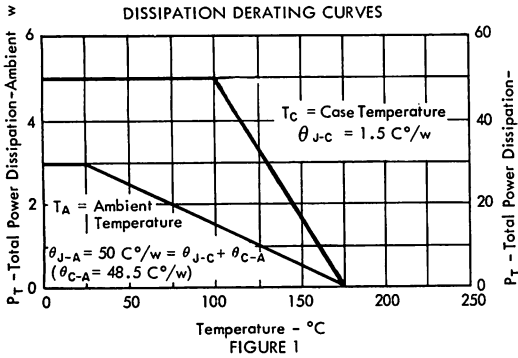

TYPICAL JUNCTION TEMPERATURE RESPONSE vs PULSE WIDTH AND DUTY CYCLE

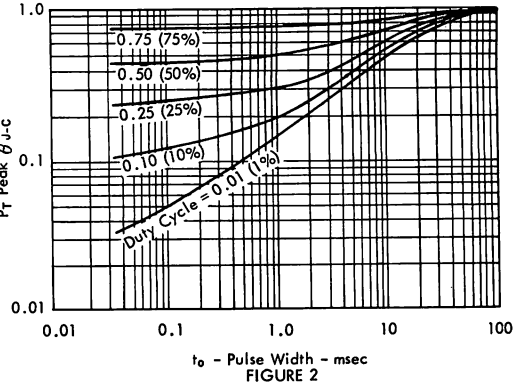

TYPICAL HEAT-SINK THERMAL RESISTANCE vs POWER DISSIPATION

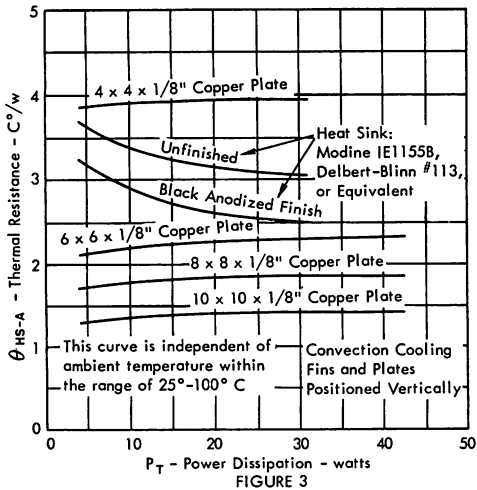

TYPICAL HEAT-SINK THERMAL RESISTANCE vs COOLING AIR VELOCITY

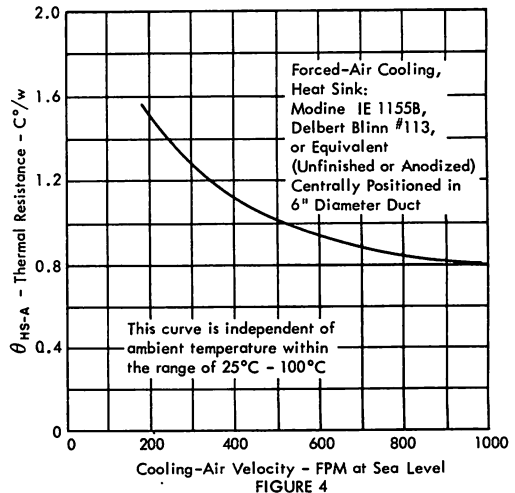

TYPES 2N1722, 2N1724

N-P-N TRIPLE-DIFFUSED MESA SILICON TRANSISTORS

THERMAL INFORMATION

TABLE I

Mounting Conditions	2N1722 mounted with four 2-56 screws at 4 in.-lb torque 2N1724 mounted at 30 in.-lb. torque			
	Unfinished Alum. or Copper	Alum. or Copper with .0025" mica ins.	Anodized Aluminum	Anodized Alum. with DC-200 Oil
θ_{C-HS} — contact thermal resistance $^{\circ}\text{C}/\text{w}$	0.15	0.45	0.40	0.28

Symbol	Definition	Unit
P_T	DC or average total power dissipation	w
$P_{T\text{peak}}$	Peak total power dissipation (pulsed operation)	w
θ_{HS-A}	Heat-sink-to-ambient thermal resistance	$^{\circ}\text{C}/\text{w}$
θ_{C-HS}	Case-to-heat-sink (contact) thermal resistance	$^{\circ}\text{C}/\text{w}$
θ_{J-C}	Junction-to-case thermal resistance	$^{\circ}\text{C}/\text{w}$
θ_{J-A}	Junction-to-ambient thermal resistance (no heat sink)	$^{\circ}\text{C}/\text{w}$
θ_{C-A}	Case-to-ambient thermal resistance (no heat sink)	$^{\circ}\text{C}/\text{w}$
T_A	Ambient temperature	$^{\circ}\text{C}$
T_{HS}	Heat-sink mounting surface temperature	$^{\circ}\text{C}$
T_C	Case temperature (transistor mounting surface)	$^{\circ}\text{C}$
$T_{J\text{max}}$	Maximum junction temperature	$^{\circ}\text{C}$
t_o	Pulse width	msec

For steady-state power dissipation or pulsed dissipation with $t_o < 100 \mu\text{sec}$, maximum junction temperature may be considered equal to the ambient temperature plus the product of average power dissipation and total junction-to-ambient thermal resistance. Under these pulse conditions, the junction-to-case temperature gradient varies so slightly with instantaneous power dissipation that average dissipation may be used in thermal calculations. When a heat sink is used, junction-to-ambient thermal resistance may be broken down into three quantities: θ_{J-C} , θ_{C-HS} , and θ_{HS-A} . Thermal performance can then be calculated using the following equation:

$$T_{J\text{max}} = T_A + P_T(\theta_{J-C} + \theta_{C-HS} + \theta_{HS-A})$$

Or, if no heat sink is used,

$$T_{J\text{max}} = T_A + P_T\theta_{J-A}$$

θ_{J-C} , θ_{J-A} , and θ_{C-A} are shown in Figure 1. To minimize contact thermal resistance, θ_{C-HS} , the heat sink mounting surface should be as smooth as possible. θ_{C-HS} for several surface and mounting conditions is given in Table 1. These figures represent maximum values encountered on surfaces equivalent to those of most commercially available heat sinks. Note that in some cases, as with the anodized aluminum finish, θ_{C-HS} can be reduced substantially by the application of a film of silicone grease between transistor and heat sink.

As t_o exceeds 100 μsec during pulsed operation, the instantaneous variation of the junction-to-case temperature gradient increases sharply. Therefore, maximum rather than average junction temperature must be considered. Figure 2 shows the ratio of maximum instantaneous case-to-junction temperature rise at any pulse width and duty cycle to the rise which would occur at 100% duty cycle. Use of this curve is best explained by the equations below and by the example problems. Provided the other operating conditions are known, $T_{J\text{max}}$ or $P_{T\text{peak}}$ may be found using the relation

$$T_{J\text{max}} = T_A + P_{T\text{peak}} \times \text{duty cycle} \times (\theta_{C-HS} + \theta_{HS-A}) + \left[\frac{T_{J\text{max}} - T_C}{P_{T\text{peak}} \theta_{J-C}} \right] P_{T\text{peak}} \theta_{J-C}$$

Or, if no heat sink is used,

$$T_{J\text{max}} = T_A + P_{T\text{peak}} \times \text{duty cycle} \times \theta_{C-A} +$$

$$\left[\frac{T_{J\text{max}} - T_C}{P_{T\text{peak}} \theta_{J-C}} \right] P_{T\text{peak}} \theta_{J-C}$$

Note that the ambient-to-transistor case temperature rise remains constant at a value proportional to average power dissipation throughout the pulse width and duty cycle range shown in Figure 2. Values for θ_{HS-A} taken from Figures 3 and 4 are used in the example problems. However, the curves in Figures 1 and 2 may be used for any heat sink provided its thermal resistance is known. Under no circumstances should peak power dissipation exceed the value indicated by the maximum V_{CE} curve on the collector characteristics.

Example 1, Find $T_{J\text{max}}$

Operating Conditions

Heat sink = Modine 1E1155B, Delbert Blinn 113, or equivalent, anodized finish, convection cooling

$t_o = 1 \text{ msec}$

duty cycle = 0.10 (10%)

$P_{T\text{peak}} = 50 \text{ w}$

$T_A = 50^{\circ}\text{C}$

$$T_{J\text{max}} = T_A + P_{T\text{peak}} \times \text{duty cycle} \times (\theta_{C-HS} + \theta_{HS-A}) +$$

$$\left[\frac{T_{J\text{max}} - T_C}{P_{T\text{peak}} \theta_{J-C}} \right] P_{T\text{peak}} \theta_{J-C}$$

From Figure 1, $\theta_{J-C} = 1.5 \text{ }^{\circ}\text{C}/\text{w}$

From Figure 3, $\theta_{HS-A} = 3.15 \text{ }^{\circ}\text{C}/\text{w}$ ($P_T = P_{T\text{peak}} \times \text{duty cycle}$)

From Table 1, $\theta_{C-HS} = 0.40 \text{ }^{\circ}\text{C}/\text{w}$

From Figure 2, $\left[\frac{T_{J\text{max}} - T_C}{P_{T\text{peak}} \theta_{J-C}} \right] = 0.20$

then

$$\begin{aligned} T_{J\text{max}} &= 50^{\circ}\text{C} + 50 \text{ w} \times 0.10 \times (3.15 + 0.40) \text{ }^{\circ}\text{C}/\text{w} + 0.20 \times 50 \text{ w} \times \\ &\quad 1.5 \text{ }^{\circ}\text{C}/\text{w} \\ &= 50 + 17.7 + 15 \\ &= 82.7^{\circ}\text{C} \end{aligned}$$

Example 2, Find $P_{T\text{peak}}$

Operating Conditions

heat sink = none

$t_o = 10 \text{ msec}$

duty cycle = 0.01 (1%)

$T_{J\text{max}}$ (design limit) = 175°C

$T_A = 25^{\circ}\text{C}$

$$T_{J\text{max}} = T_A + P_{T\text{peak}} \times \text{duty cycle} \times \theta_{C-A} +$$

$$\left[\frac{T_{J\text{max}} - T_C}{P_{T\text{peak}} \theta_{J-C}} \right] P_{T\text{peak}} \theta_{J-C}$$

From Figure 1, $\theta_{C-A} = 48.5 \text{ }^{\circ}\text{C}/\text{w}$

From Figure 1, $\theta_{J-C} = 1.5 \text{ }^{\circ}\text{C}/\text{w}$

From Figure 2, $\left[\frac{T_{J\text{max}} - T_C}{P_{T\text{peak}} \theta_{J-C}} \right] = 0.50$

then

$$\begin{aligned} 175^{\circ}\text{C} &= 25^{\circ}\text{C} + P_{T\text{peak}} \times 0.01 \times 48.5 \text{ }^{\circ}\text{C}/\text{w} + 0.50 \times \\ &\quad P_{T\text{peak}} \times 1.5 \text{ }^{\circ}\text{C}/\text{w} \\ P_{T\text{peak}} &= \frac{150}{0.485 + 0.75} \equiv 121 \text{ watts} \end{aligned}$$

TYPES 2N1722, 2N1724 N-P-N TRIPLE-DIFFUSED MESA SILICON TRANSISTORS

TYPICAL APPLICATION DATA, $T_A = -55^\circ\text{C}$ TO 125°C .

35 watt, 400 cps SERVO AMPLIFIER

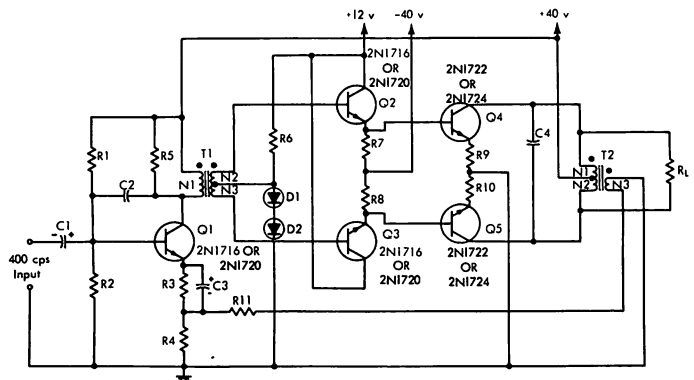

Circuit Characteristics at 35 w
Power Output:

Power Gain - 45 db min.

Voltage Amplification -
 36.5 ± 1.5 db

Circuit Input Resistance - 700 Ω
min.

Total Harmonic Distortion - 5%

R_L - 68, 35 w

R1 - 4.32 K, 1/2 w

R2 - 3.32 K, 1/2 w

R3 - 1.00 K, 1 w

R4 - 33.2, 1/2 w

R5 - 2.21 K, 1/2 w

R6 - 390, 1/2 w

R7 & R8 - 2.00 K, 1 w

R9 & R10 - 1.00, 2 w

R11 - 1.00 K, 1/2 w

C1 - 40 μf , 25 v

C2 - 500 pf, 100 v

C3 - 1000 μf , 25 v

C4 - 2.0 μf , 100 v

D1 & D2 - T1 1N538

Q1, Q2, & Q3 - T1 2N1716

OR T1 2N1720

Q4 & Q5 - T1 2N1722

OR T1 2N1724

T1: N1 = 755 T, #30 AWG; N2 = N3 = 330 T,
#28 AWG Bifilar Wound.

Core - Magnetic Metals 75E1 SL14 or
equivalent - 1 x 1 interleaved.

T2: N1 = N2 = 100 T, #20 AWG Bifilar
Wound; N3 = 67 T, #28 AWG.

Core - Magnetic Metals 100 E1 SL14 or
equivalent - Butt Joint.

NOTES: 1. All Resistance Values in ohms - 5% Tolerance

2. Resistor Wattage Ratings at 125°C Ambient

3. Capacitor Voltage Ratings at 125°C Ambient

4. Q1 on Heat Sink with $\theta_{C-HS} + \theta_{HS-A} \leq 40^\circ\text{C}/\text{w}$

5. Q2 and Q3 on same Heat Sink. $\theta_{C-HS} + \theta_{HS-A} \leq 40^\circ\text{C}/\text{w}$ each. h_{FE} 's matched within 10%.

6. Q4 and Q5 on Heat Sinks with $\theta_{C-HS} + \theta_{HS-A} \leq 1.5^\circ\text{C}/\text{w}$. h_{FE} 's matched within 10%.

120 watt 10 Kc DC-DC CONVERTER

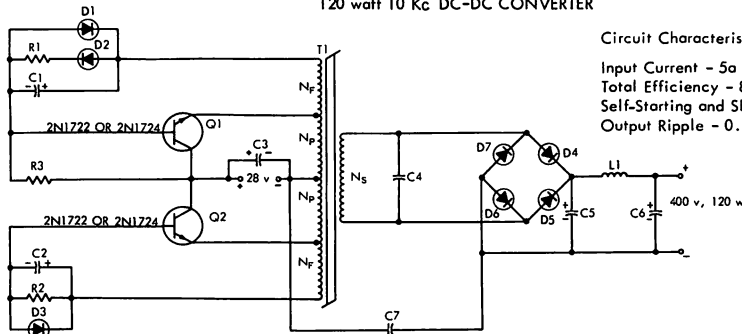

Circuit Characteristics at 120 w Power Output:

Input Current - 5a

Total Efficiency - 85%

Self-Starting and Short-Circuit Protected

Output Ripple - 0.6 v max.

Q1 & Q2 - T1 2N1722
OR T1 2N1724

D1 - D3 - T1 1N645

D4 - D7 - T1 1N1096

C1 & C2 - 22 μf , 15 v

C3 - 100 μf , 35 v

C4 - 510 pf, 500 v

C5 - 0.1 μf , 500 v

C6 - 3 μf , 500 v

C7 - 0.01 μf , 500 v

L1 - 15 μh

R1 - 2.74, 2 w

R2 - 3.32, 2 w

R3 - 511, 2 w

T1: Np = 18 T #16 AWG

Ns = 290 T #25 AWG

Nf = 3 T #22 AWG

Core: Toroid, Magnetic Metals Inc. 51026-ID
or equivalent.

NOTES: 1. All Resistance Values in ohms, 5% Tolerance.

2. All Resistor Wattage Ratings at 125°C Ambient.

3. Capacitor Voltage Ratings at 125°C Ambient.

4. Q1 and Q2 on Same Heat Sink, $\theta_{C-HS} + \theta_{HS-A} \leq 4^\circ\text{C}/\text{w}$ each.

TYPES 2N1722, 2N1724 N-P-N TRIPLE-DIFFUSED MESA SILICON TRANSISTORS

TYPICAL APPLICATION DATA, $T_A = -55^\circ\text{C}$ TO 125°C .

30 volt, 0 - 2.5 a VOLTAGE REGULATOR

Circuit Characteristics:

$$\frac{\Delta V_{OUT}}{\Delta I_{OUT}} \Big|_{\Delta V_{IN} = 0} = \text{Output Resistance} \leq 0.007 \text{ ohm}$$

$$100X \frac{\Delta V_{OUT}}{\Delta V_{IN}} \Big|_{\Delta I_{OUT} = 0} = \text{Input Regulation} \leq 0.05\% \text{ at } I_{OUT} = 2.0 \text{ a}$$

$$100X \frac{\Delta V_{OUT}/V_{OUT}}{\Delta T_A} \Big|_{\Delta V_{IN} = 0} = \text{Output Voltage Temperature Coefficient} \leq 0.007\%/^\circ\text{C} \text{ at } I_{OUT} = 2.0 \text{ a}, V_{IN} = 45 \text{ v}$$

$$\frac{\text{Input Ripple}}{\text{Output Ripple}} = \text{Ripple Reduction} \geq 10,000$$

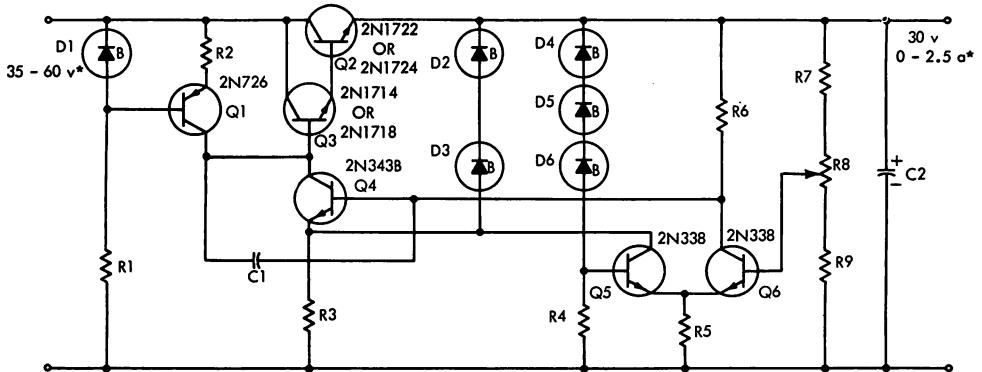

Q1 - TI 2N726	Q4 - TI 2N343B	C1 - 0.01 μf , 50 v	R4 - 2.43 K, 1/4 w (Wirewound)
Q2 - TI 2N1722 OR TI 2N1724	Q5 & Q6 - TI 2N338	C2 - 100 μf , 50 v	R5 - 35.7 K, 1/4 w
Q3 - TI 2N1714 OR TI 2N1718	D1 - TI 1N746	R1 - 5.11 K, 1/2 w	R6 - 35.7 K, 1/4 w
	D2 & D3 - TI 1N751	R2 - 681, 1/4 w	R7 & R9 - 3.57 K, 1/4 w (Wirewound)
	D4 - D6 - TI 1N752A	R3 - 2.00 K, 1/4 w	R8 - 200, 1/4 w (Wirewound)

- NOTES:
- All Resistor Values in ohms, 5% Tolerance.
 - Resistor Wattage Ratings at 125°C Ambient.
 - Capacitor Voltage Ratings at 125°C Ambient.
 - Q2 and Q3 on Same Heat Sink: Q2: $\theta_{C-HS} + \theta_{HS-A} \leq 2 \text{ C}^\circ/\text{w}$
Q3: $\theta_{C-HS} + \theta_{HS-A} \leq 22 \text{ C}^\circ/\text{w}$
 - Q5 and Q6 on Same Heat Sink: Each, $\theta_{C-HS} + \theta_{HS-A} \leq 80 \text{ C}^\circ/\text{w}$

*See Voltage - Current Derating Curves Below

MAXIMUM ALLOWABLE INPUT VOLTAGE vs OUTPUT CURRENT - 0-2.5 a VOLTAGE REGULATOR

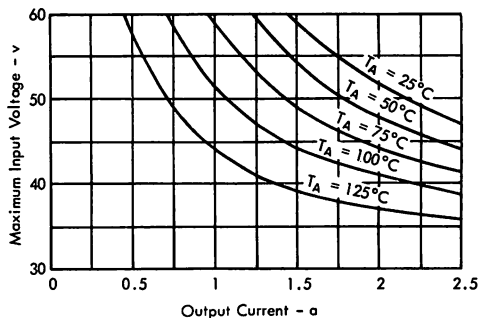

TYPES 2N2987, 2N2988, 2N2989, 2N2990, 2N2991, 2N2992, 2N2993, 2N2994 N-P-N TRIPLE-DIFFUSED MESA SILICON TRANSISTORS



TYPES 2N2987, 2N2988, 2N2989, 2N2990
2N2991, 2N2992, 2N2993, 2N2994
BULLETIN NO. DL-5 634284, AUGUST 1963

PLANAR INTERMEDIATE-POWER TRANSISTORS

- 15 Watts at 100°C Case Temperature
- Nanoampere Leakages
- Beta Guaranteed at Seven Levels
- Guaranteed Parameters from -55°C to +175°C
- Minimum f_T of 30 mc

*mechanical data

The transistors are in a hermetically-sealed welded package with glass-to-metal seal between case and leads.

THE COLLECTOR IS IN ELECTRICAL CONTACT WITH THE CASE.

2N 2987, 2N 2988, 2N 2989, 2N 2990

FALLS WITHIN TO-5 DIMENSIONS

2N 2991, 2N 2992, 2N 2993, 2N 2994

DIMENSIONS ARE IN INCHES UNLESS OTHERWISE SPECIFIED

A. The specified lead diameter applies in the zone between .050" and .250" from the seating plane. Between .250" and 1.5" a maximum of .021" diameter is held. Outside of these zones the lead diameter is not controlled.

B. Measured from max. diameter of the actual device.

C. Leads having maximum diameter (0.019") measured in gaging plane 0.054" ± 0.001" - 0.000" below the seating plane of the device shall be within 0.007" of their true locations relative to a maximum-width tab.

D. The device may be measured by direct methods or by the gage and gaging procedure described on the JEDEC TO-5 base gage drawing.

E. Crimping is used to secure the "thermoslug" heat sink in place.

F. The can diameter referenced is exclusive of crimping.

G. The orientation of the leads in relation to the heat flats is not controlled.

H. Temperature measurement point 0.050 nominal from seat of heat sink.

*absolute maximum ratings at 25°C case temperature (unless otherwise noted)

	2N2987 2N2989	2N2991 2N2993	2N2988 2N2990	2N2992 2N2994
Collector-Base Voltage	95 v		155 v	
Collector-Emitter Voltage (See Note 1)	80 v		100 v	
Emitter-Base Voltage	7 v		7 v	
Collector Current, Continuous	← 1.0 a →			
Base Current, Continuous	← 0.2 a →			
Total Device Dissipation at (or below) 25°C Free-Air Temperature (See Note 2)	1 w	2 w	1 w	2 w
Total Device Dissipation at (or below) 100°C Case Temperature (See Note 3)	← 15 w →			
Operating Case Temperature Range	- 65°C to + 200°C			
Storage Temperature Range	- 65°C to + 200°C			
Lead Temperature 1/8" from Case for 10 Seconds	← 230°C →			

- NOTES: 1. This value applies when base-emitter diode is open-circuited.
 2. Derate linearly to 200°C free-air temperature at the rate of 5.7 mw/°C for the TO-5 series and 11.4 mw/°C for the studed series.
 3. Derate linearly to 200°C case temperature at the rate of 150 mw/°C.
 *Indicates JEDEC registered data.



TEXAS INSTRUMENTS
INCORPORATED
POST OFFICE BOX 5012 • DALLAS, TEXAS 75222

**TYPES 2N2987, 2N2988, 2N2989, 2N2990,
2N2991, 2N2992, 2N2993, 2N2994
N-P-N TRIPLE-DIFFUSED MESA SILICON TRANSISTORS**

*electrical characteristics at 25°C case temperature (unless otherwise noted)

PARAMETER	TEST CONDITIONS	2N2987 2N2991		2N2988 2N2992		2N2989 2N2993		2N2990 ← 2N2994 ←		TO-5 STUD
		MIN	MAX	MIN	MAX	MIN	MAX	MIN	MAX	UNIT
V_{CE0} Collector-Emitter Breakdown Voltage	$I_C = 30 \text{ ma}$, $I_B = 0$, (See Note 4)	80		100		80		100		v
I_{CEO} Collector Cutoff Current	$V_{CE} = 50 \text{ v}$, $I_B = 0$	0.1				0.1				μa
	$V_{CE} = 90 \text{ v}$, $I_B = 0$			0.1				0.1		
I_{CEX} Collector Cutoff Current	$V_{CE} = 90 \text{ v}$, $V_{BE} = -1.5 \text{ v}$	0.025				0.025				μa
	$V_{CE} = 150 \text{ v}$, $V_{BE} = -1.5 \text{ v}$			0.025				0.025		
	$V_{CE} = 90 \text{ v}$, $V_{BE} = -1.5 \text{ v}$, $T_C = 175^\circ\text{C}$	15				15				
	$V_{CE} = 150 \text{ v}$, $V_{BE} = -1.5 \text{ v}$, $T_C = 175^\circ\text{C}$			15				15		
I_{EBO} Emitter Cutoff Current	$V_{EB} = 7 \text{ v}$, $I_C = 0$	0.025		0.025		0.025		0.025		μa
h_{FE} Static Forward Current Transfer Ratio	$V_{CE} = 5 \text{ v}$, $I_C = 1 \text{ ma}$, (See Note 4)	20		20		40		40		
	$V_{CE} = 5 \text{ v}$, $I_C = 200 \text{ ma}$, (See Note 4)	25	75	25	75	60	120	60	120	
	$V_{CE} = 5 \text{ v}$, $I_C = 500 \text{ ma}$, (See Note 4)	20		20		40		40		
	$V_{CE} = 10 \text{ v}$, $I_C = 100 \text{ ma}$, (See Note 4)	25		25		50		50		
	$V_{CE} = 5 \text{ v}$, $I_C = 200 \text{ ma}$, $T_A = -55^\circ\text{C}$, (See Note 4)	10		10		20		20		
V_{BE} Base-Emitter Voltage	$V_{CE} = 5 \text{ v}$, $I_C = 200 \text{ ma}$, (See Note 4)	0.9		0.9		0.9		0.9		v
	$I_B = 20 \text{ ma}$, $I_C = 200 \text{ ma}$, (See Note 4)	1.0		1.0		1.0		1.0		
	$I_B = 50 \text{ ma}$, $I_C = 500 \text{ ma}$, (See Note 4)	1.4		1.4		1.4		1.4		
$V_{CE(sat)}$ Collector-Emitter Saturation Voltage	$I_B = 20 \text{ ma}$, $I_C = 200 \text{ ma}$, (See Note 4)	0.8		0.8		0.8		0.8		v
	$I_B = 50 \text{ ma}$, $I_C = 500 \text{ ma}$, (See Note 4)	3.0		3.0		3.0		3.0		
h_{fo} Small-Signal Common-Emitter Forward Current Transfer Ratio	$V_{CE} = 10 \text{ v}$, $I_C = 100 \text{ ma}$, $f = 1 \text{ kc}$	25	85	25	85	50	170	50	170	
$ h_{fo} $ Small-Signal Common-Emitter Forward Current Transfer Ratio	$V_{CE} = 10 \text{ v}$, $I_C = 100 \text{ ma}$, $f = 30 \text{ mc}$	1		1		1		1		
C_{ob} Common-Base Open-Circuit Output Capacitance	$V_{CB} = 10 \text{ v}$, $I_E = 0$, $f = 1 \text{ mc}$	50		50		50		50		pf

NOTE: 4. This parameter must be measured using pulse techniques. PW = 300 μsec , Duty Cycle $\leq 2\%$.

*Indicates JEDEC registered data.

TYPES 2N2987, 2N2988, 2N2989, 2N2990, 2N2991, 2N2992, 2N2993, 2N2994

N-P-N TRIPLE-DIFFUSED MESA SILICON TRANSISTORS

TYPICAL CHARACTERISTICS

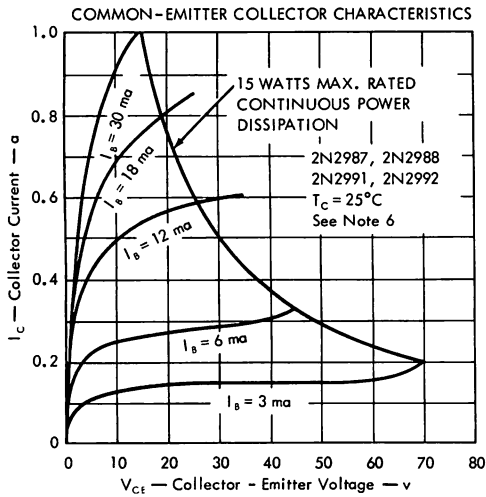

FIGURE 1

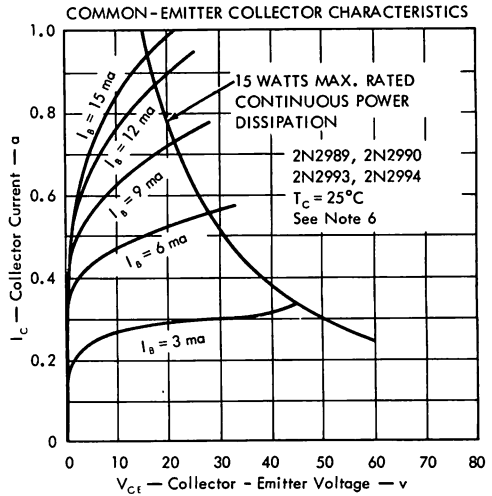

FIGURE 2

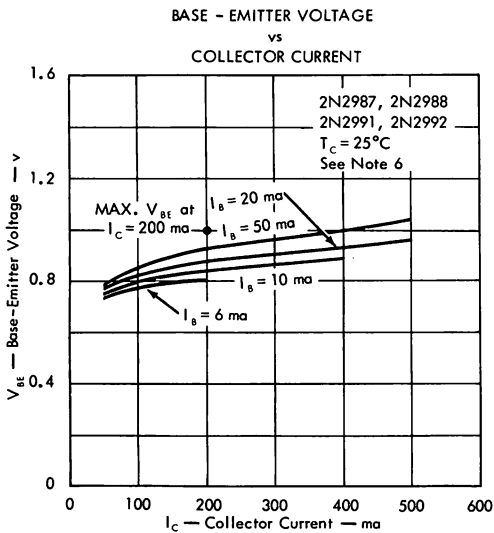

FIGURE 3

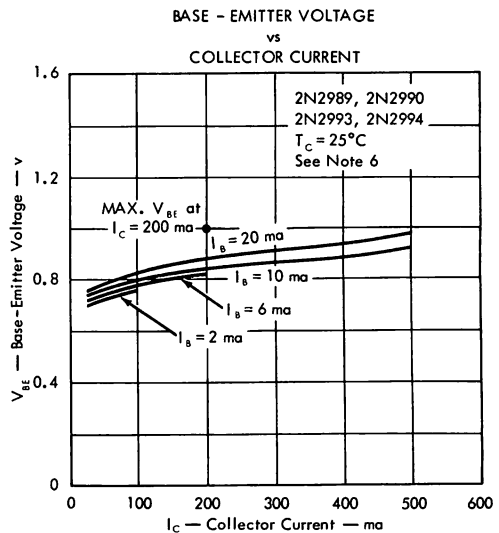

FIGURE 4

NOTE: 6. These characteristics were measured using pulse techniques. $PW = 300 \mu\text{sec}$, Duty Cycle $\leq 2\%$.

TYPES 2N2987, 2N2988, 2N2989, 2N2990, 2N2991, 2N2992, 2N2993, 2N2994

N-P-N TRIPLE-DIFFUSED MESA SILICON TRANSISTORS

TYPICAL CHARACTERISTICS

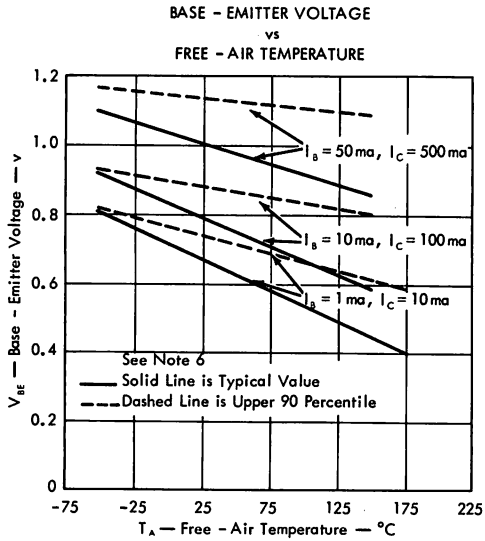

FIGURE 5

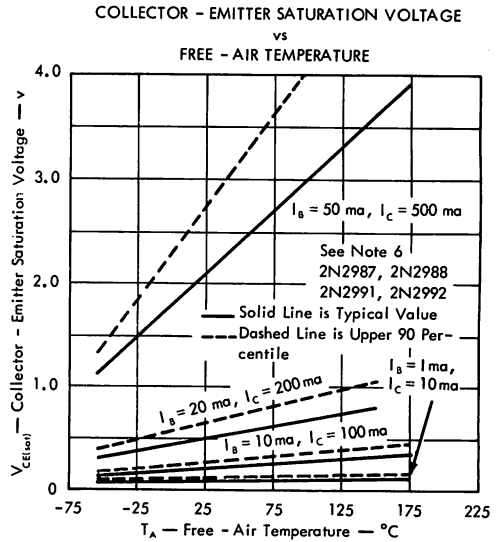

FIGURE 6

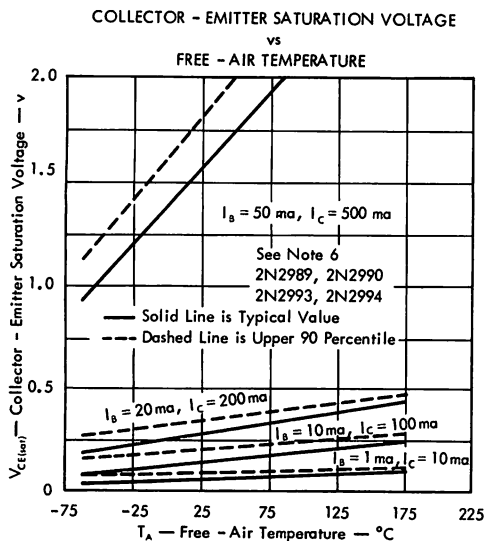

FIGURE 7

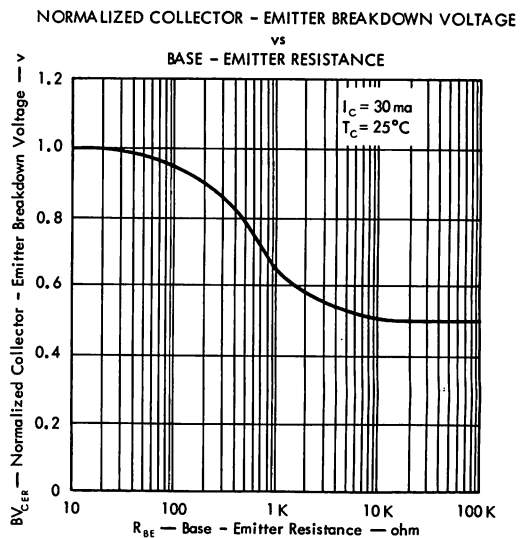

FIGURE 8

NOTE: 6. These characteristics were measured using pulse techniques. PW = 300 μ sec, Duty Cycle \leq 2%.

TYPES 2N2987, 2N2988, 2N2989, 2N2990, 2N2991, 2N2992, 2N2993, 2N2994

N-P-N TRIPLE-DIFFUSED MESA SILICON TRANSISTORS

TYPICAL CHARACTERISTICS

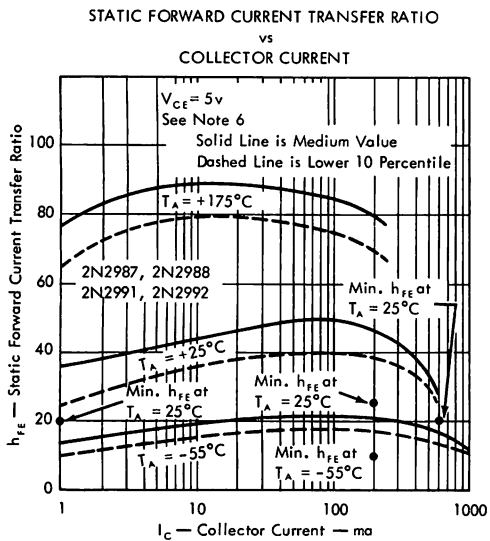

FIGURE 9

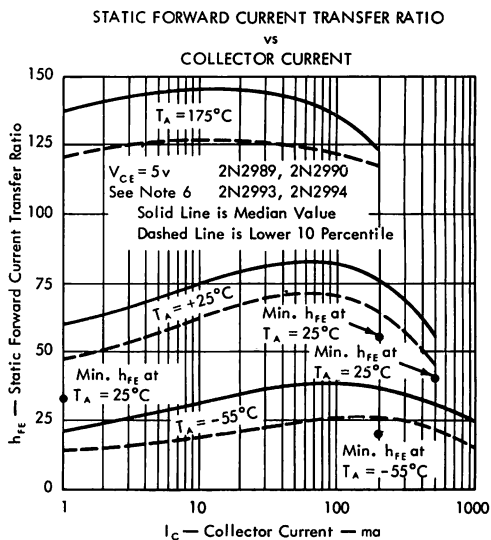

FIGURE 10

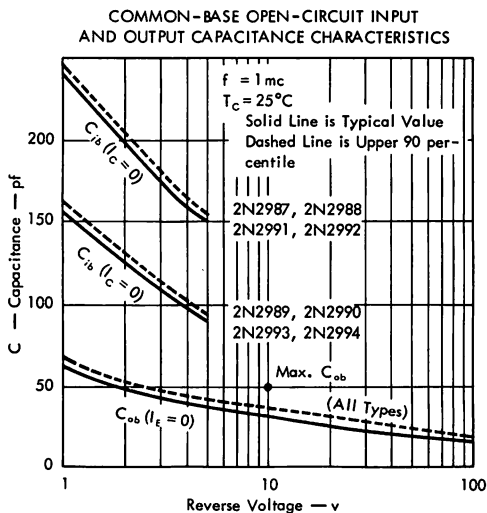

FIGURE 11

NOTE: 6. These characteristics were measured using pulse techniques. PW = 300 μ sec, Duty Cycle \leq 2%.

TYPES 2N2987, 2N2988, 2N2989, 2N2990, 2N2991, 2N2992, 2N2993, 2N2994

N-P-N TRIPLE-DIFFUSED MESA SILICON TRANSISTORS

THERMAL INFORMATION

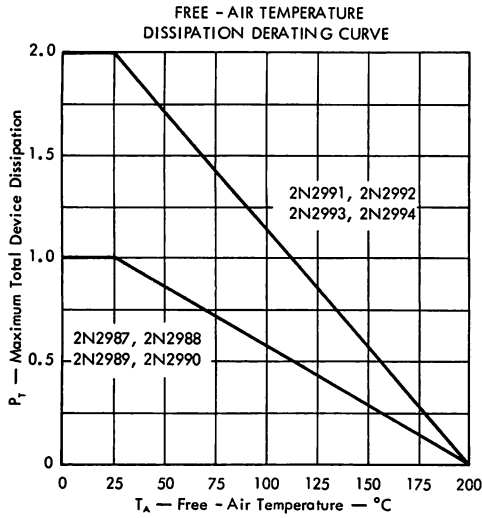

FIGURE 12

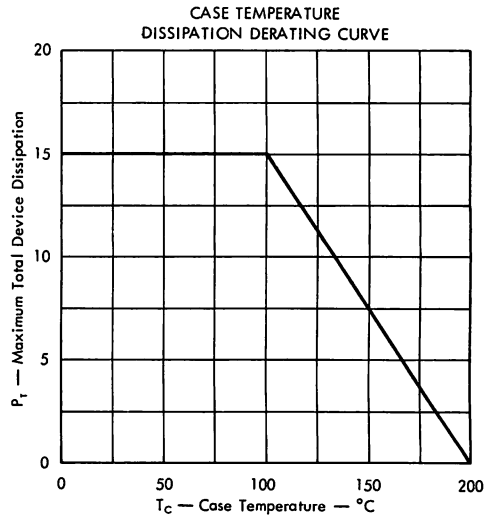

FIGURE 13

MAXIMUM SAFE CONTINUOUS OPERATING REGIONS

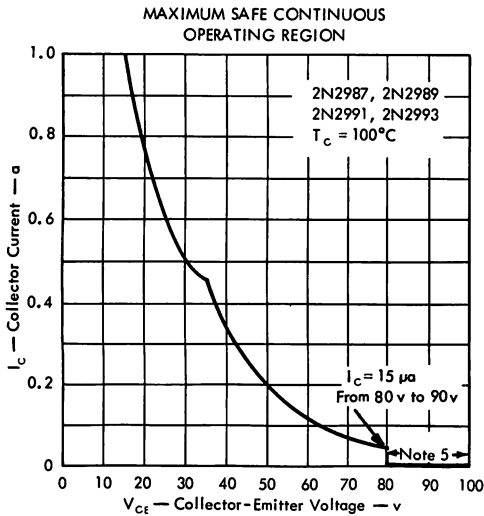

FIGURE 14

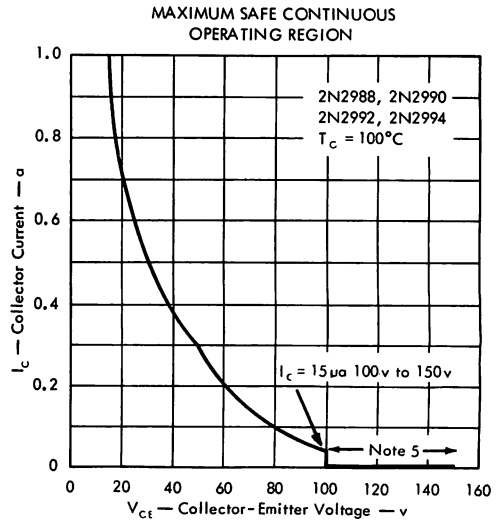

FIGURE 15

NOTE: 5. Operation in this region is permissible only when the base is reverse-voltage-biased with respect to the emitter.

TYPE 2N3055 N-P-N SINGLE-DIFFUSED MESA SILICON POWER TRANSISTOR



TYPE 2N3055
BULLETIN N.O. DL-5 689659, AUGUST 1967
REVISED JULY 1968

FOR POWER-AMPLIFIER APPLICATIONS

- 115 W at 25°C Case Temperature
- Max I_C of 15 A
- Min f_{hfe} of 20 kHz

*mechanical data

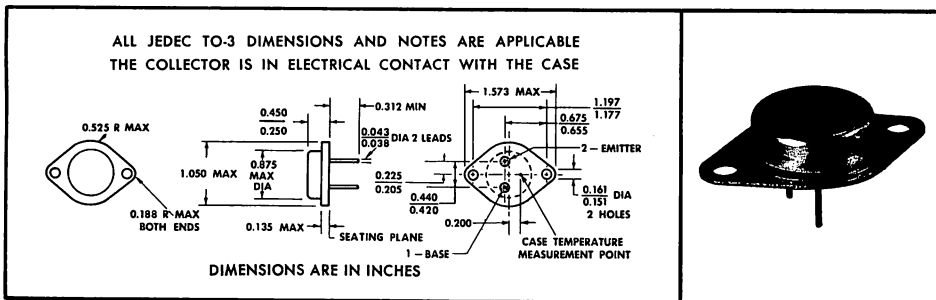

*absolute maximum ratings at 25°C case temperature (unless otherwise noted)

Collector-Base Voltage	100 V
Collector-Emitter Voltage (See Note 1)	70 V
Emitter-Base Voltage	7 V
Continuous Collector Current	15 A
Continuous Base Current	7 A
Continuous Device Dissipation at (or below) 25°C Case Temperature (See Note 2)	115 W
Operating Case Temperature Range	-65°C to 200°C
Storage Temperature Range	-65°C to 200°C
Lead Temperature ½ Inch from Case for 10 Seconds	235°C

NOTES: 1. This value applies when the base-emitter resistance $R_{BE} = 100 \Omega$.

2. Derate linearly to 200°C case temperature at the rate of 0.66 W/deg.

*Indicates JEDEC registered data



TEXAS INSTRUMENTS
INCORPORATED
POST OFFICE BOX 5012 • DALLAS, TEXAS 75222

TYPE 2N3055

N-P-N SINGLE-DIFFUSED MESA SILICON POWER TRANSISTOR

*electrical characteristics at 25°C case temperature (unless otherwise noted)

PARAMETER		TEST CONDITIONS	MIN	MAX	UNIT
$V_{(BR)CEO}$	Collector-Emitter Breakdown Voltage	$I_C = 200 \text{ mA}$, $I_B = 0$, See Note 4	60		V
$V_{(BR)CER}$	Collector-Emitter Breakdown Voltage	$I_C = 200 \text{ mA}$, $R_{BE} = 100 \Omega$	70		V
I_{CEO}	Collector Cutoff Current	$V_{CE} = 30 \text{ V}$, $I_B = 0$		0.7	mA
I_{CEV}	Collector Cutoff Current	$V_{CE} = 100 \text{ V}$, $V_{BE} = -1.5 \text{ V}$		5	mA
		$V_{CE} = 100 \text{ V}$, $V_{BE} = -1.5 \text{ V}$, $T_C = 150^\circ\text{C}$		30	
I_{EBO}	Emitter Cutoff Current	$V_{EB} = 7 \text{ V}$, $I_C = 0$		5	mA
h_{FE}	Static Forward Current Transfer Ratio	$V_{CE} = 4 \text{ V}$, $I_C = 4 \text{ A}$, See Notes 3 and 4	20	70	
		$V_{CE} = 4 \text{ V}$, $I_C = 10 \text{ A}$, See Notes 3 and 4	5		
V_{BE}	Base-Emitter Voltage	$V_{CE} = 4 \text{ V}$, $I_C = 4 \text{ A}$, See Notes 3 and 4		1.8	V
$V_{CE(sat)}$	Collector-Emitter Saturation Voltage	$I_B = 400 \text{ mA}$, $I_C = 4 \text{ A}$, See Notes 3 and 4		1.1	V
		$I_B = 3.3 \text{ A}$, $I_C = 10 \text{ A}$, See Notes 3 and 4		8	
h_{fo}	Small-Signal Common-Emitter Forward Current Transfer Ratio	$V_{CE} = 4 \text{ V}$, $I_C = 1 \text{ A}$, $f = 1 \text{ kHz}$	15	120	
f_{hfe}	Small-Signal Common-Emitter Forward Current Transfer Ratio Cutoff Frequency	$V_{CE} = 4 \text{ V}$, $I_C = 1 \text{ A}$, See Note 5	20		kHz

NOTES: 3. These parameters must be measured using pulse techniques. $t_p = 300 \mu\text{s}$, duty cycle $\leq 2\%$.

4. These parameters are measured with voltage-sensing contacts separate from the current-carrying contacts.

5. f_{hfe} is the frequency at which the magnitude of the small-signal forward current transfer ratio is 0.707 of its low-frequency value. For this device, the reference measurement is made at 1 kHz.

*Indicates JEDEC registered data

thermal characteristics

PARAMETER		MAX	UNIT
θ_{J-C}	Junction-to-Case Thermal Resistance	1.52	deg/W

TYPES 2N3418, 2N3419, 2N3420, 2N3421 N-P-N EPITAXIAL PLANAR SILICON MEDIUM-POWER TRANSISTORS



TYPES 2N3418, 2N3419, 2N3420, 2N3421
BULLETIN NO. DL-5 685521, JUNE 1964
REPLACES BULLETIN NO. DL-5 645114, MARCH 1964
REVISED MAY 1968

HIGH-FREQUENCY MEDIUM-POWER TRANSISTORS Formerly TIX3033, TIX3034, TIX3035, TIX3036

- **High-Power Dissipation in TO-5 Package:** 15 watts at $T_c = 100^\circ\text{C}$
- **Low-Leakage Current:** $0.5 \mu\text{a}$ at max voltage
- **Low-Saturation Voltage:** $V_{CE(sat)} = 0.25 \text{ v max}$ at $I_c = 1 \text{ a}$
- **High f_T :** 40 Mc min at 10 v, 100 ma

mechanical data

These transistors are in precision welded, hermetically sealed enclosures. Extreme cleanliness during the assembly process prevents sealed-in contamination. The approximate unit weight is 1.8 grams.

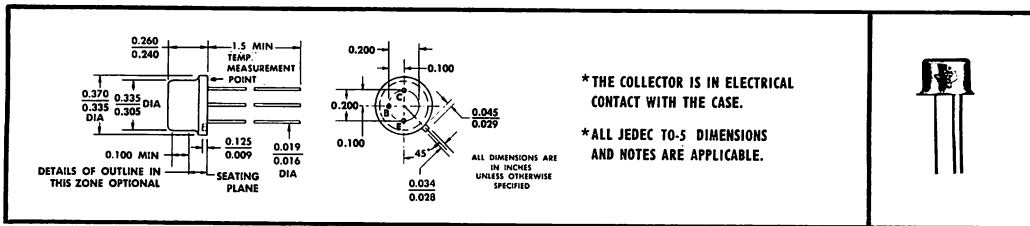

*absolute maximum ratings at 25°C case temperature (unless otherwise noted)

	2N3418	2N3419
Collector-Base Voltage	85 v	125 v
Collector-Emitter Voltage (See Note 1)	60 v	80 v
Emitter-Base Voltage	← 8 v →	← 8 v →
Collector Current, Continuous	← 3 a →	← 3 a →
Collector Current, Peak (See Note 2)	← 5 a →	← 5 a →
Base Current	← 1 a →	← 1 a →
Safe Operating Region	See Figures 8 and 9	
Total Device Dissipation at (or below) 100°C Case Temperature (See Note 3)	← 15 w →	← 15 w →
Total Device Dissipation at (or below) 25°C Free-Air Temperature (See Note 4)	← 1 w →	← 1 w →
Operating Case Temperature Range	-65°C to 200°C	
Storage Temperature Range	-65°C to 200°C	
Lead Temperature $\frac{1}{16}$ Inch from Case for 10 Seconds	← 230°C →	

- NOTES: 1. These values apply when the base-emitter diode is open-circuited.
 2. This value applies for $PW \leq 1 \text{ msec}$, Duty Cycle $\leq 50\%$.
 3. Derate linearly to 200°C case temperature at the rate of 0.15 w/C°.
 4. Derate linearly to 200°C free-air temperature at the rate of 5.72 mw/C°.

*Indicates JEDEC registered data.



TEXAS INSTRUMENTS
INCORPORATED
POST OFFICE BOX 5012 • DALLAS, TEXAS 75222

TYPES 2N3418, 2N3419, 2N3420, 2N3421

N-P-N EPITAXIAL PLANAR SILICON MEDIUM-POWER TRANSISTORS

*electrical characteristics at 25°C case temperature (unless otherwise noted)

PARAMETER	TEST CONDITIONS	2N3418		2N3419		2N3420		2N3421		UNIT
		MIN	MAX	MIN	MAX	MIN	MAX	MIN	MAX	
V_{CE0} Collector-Emitter Breakdown Voltage	$I_C = 50 \text{ ma}$, $I_B = 0$, See Note 5	60		80		60		80		v
I_{CEX} Collector Cutoff Current	$V_{CE} = 80 \text{ v}$, $V_{BE} = -0.5 \text{ v}$	0.5				0.5				μa
	$V_{CE} = 120 \text{ v}$, $V_{BE} = -0.5 \text{ v}$			0.5				0.5		μa
	$V_{CE} = 80 \text{ v}$, $V_{BE} = -0.5 \text{ v}$, $T_C = 150^\circ\text{C}$	50				50				μa
	$V_{CE} = 120 \text{ v}$, $V_{BE} = -0.5 \text{ v}$, $T_C = 150^\circ\text{C}$			50				50		μa
I_{EBO} Emitter Cutoff Current	$V_{EB} = 6 \text{ v}$, $I_C = 0$	500		500		500		500		na
	$V_{EB} = 8 \text{ v}$, $I_C = 0$	10		10		10		10		μa
h_{FE} Static Forward Current Transfer Ratio	$V_{CE} = 2 \text{ v}$, $I_C = 100 \text{ ma}$, See Notes 5 and 6	20		20		40		40		
	$V_{CE} = 2 \text{ v}$, $I_C = 1 \text{ a}$, See Notes 5 and 6	20	60	20	60	40	120	40	120	
	$V_{CE} = 2 \text{ v}$, $I_C = 2 \text{ a}$, See Notes 5 and 6	15		15		30		30		
	$V_{CE} = 5 \text{ v}$, $I_C = 5 \text{ a}$, See Notes 5 and 6	10		10		15		15		
	$V_{CE} = 2 \text{ v}$, $I_C = 1 \text{ a}$, $T_C = -55^\circ\text{C}$ See Notes 5 and 6	10		10		10		10		
V_{BE} Base-Emitter Voltage	$I_B = 100 \text{ ma}$, $I_C = 1 \text{ a}$, See Notes 5 and 6	0.6	1.2	0.6	1.2	0.6	1.2	0.6	1.2	v
	$I_B = 200 \text{ ma}$, $I_C = 2 \text{ a}$, See Notes 5 and 6	0.7	1.4	0.7	1.4	0.7	1.4	0.7	1.4	v
$V_{CE(sat)}$ Collector-Emitter Saturation Voltage	$I_B = 100 \text{ ma}$, $I_C = 1 \text{ a}$, See Notes 5 and 6	0.25		0.25		0.25		0.25		v
	$I_B = 200 \text{ ma}$, $I_C = 2 \text{ a}$, See Notes 5 and 6	0.5		0.5		0.5		0.5		v
$ h_{fe} $ Small-Signal Common-Emitter Forward Current Transfer Ratio	$V_{CE} = 10 \text{ v}$, $I_C = 100 \text{ ma}$, $f = 20 \text{ Mc}$	2		2		2		2		
C_{ob} Common-Base Open-Circuit Output Capacitance	$V_{CB} = 10 \text{ v}$, $I_E = 0$, $f = 1 \text{ Mc}$	150		150		150		150		pf

NOTES: 5. These parameters must be measured using pulse techniques. $PW = 300 \mu\text{sec}$, Duty Cycle $\leq 2\%$.

6. These parameters are measured with voltage-sensing contacts located 0.25 in. from the header of the transistor. Voltage-sensing contacts are separate from current-carrying contacts.

*switching characteristics at 25°C free-air temperature

PARAMETER	TEST CONDITIONS†	TYP	MAX	UNIT
t_{on} Turn-On Time	$I_C = 1 \text{ a}$, $I_{B(1)} = 100 \text{ ma}$, $I_{B(2)} = -100 \text{ ma}$,	165	300	nsec
t_{off} Turn-Off Time	$V_{BE(off)} = -3.7 \text{ v}$, $R_L = 20 \Omega$, See Figure 10	540	1200	
t_{on} Turn-On Time	$I_C = 2 \text{ a}$, $I_{B(1)} = 200 \text{ ma}$, $I_{B(2)} = -200 \text{ ma}$,	200		
t_{off} Turn-Off Time	$V_{BE(off)} = -4.7 \text{ v}$, $R_L = 20 \Omega$, See Figure 10	350		

†Voltage and current values shown are nominal; exact values vary slightly with transistor parameters.

*Indicates JEDEC registered data (typical values excluded).

TYPES 2N3418, 2N3419, 2N3420, 2N3421 N-P-N EPITAXIAL PLANAR SILICON MEDIUM-POWER TRANSISTORS

TYPICAL CHARACTERISTICS

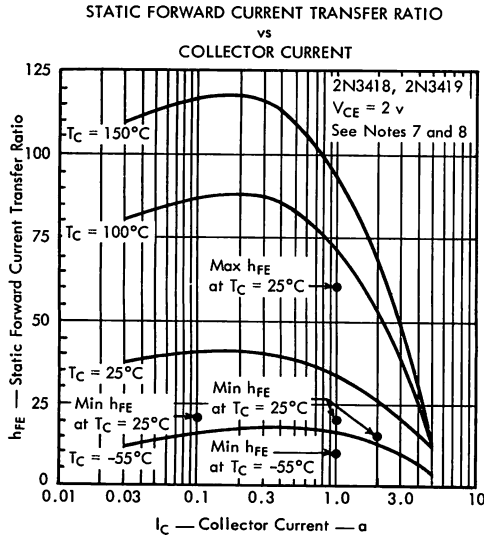

FIGURE 1

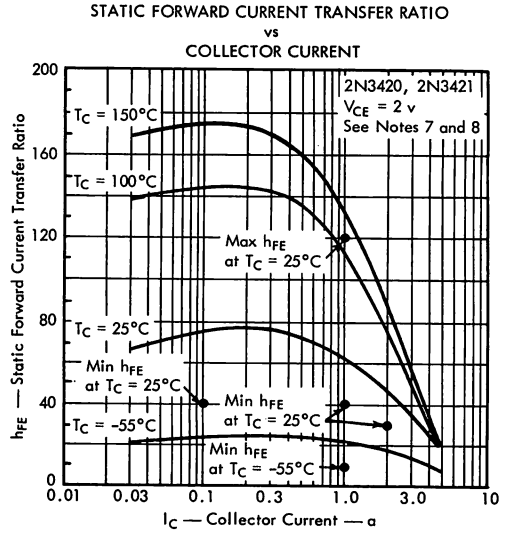

FIGURE 2

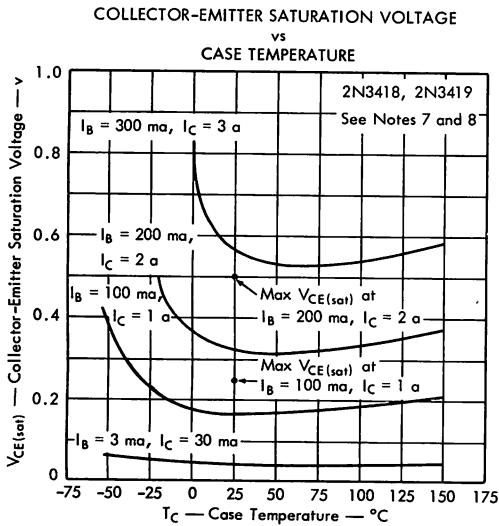

FIGURE 3

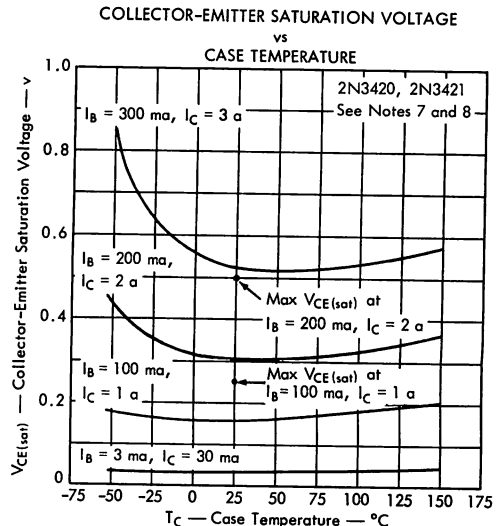

FIGURE 4

NOTES: 7. These parameters were measured using pulse techniques. $PW = 300 \mu\text{sec}$. Duty Cycle $\leq 2\%$.

8. Separate voltage-sensing and current-carrying contacts were used.

TYPES 2N3418, 2N3419, 2N3420, 2N3421

N-P-N EPITAXIAL PLANAR SILICON MEDIUM-POWER TRANSISTORS

TYPICAL CHARACTERISTICS

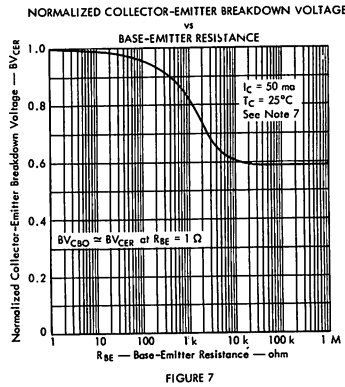
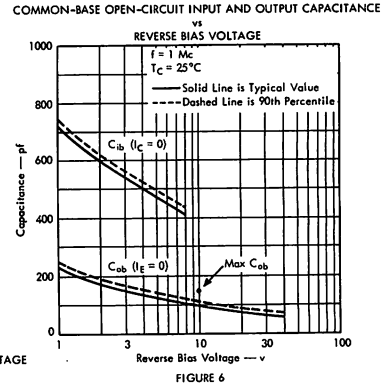
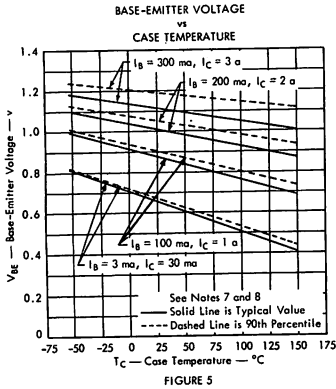

MAXIMUM SAFE OPERATING REGION

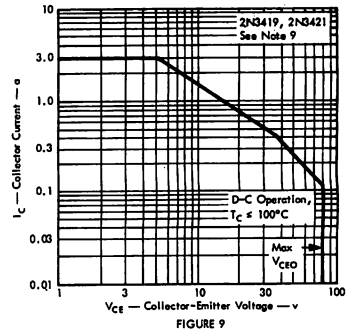
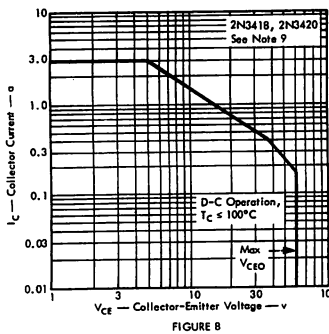

NOTE 9: Operation above maximum V_{CEO} is permissible if the base is reverse-voltage-biased with respect to the emitter and the collector-base voltage rating is not exceeded.

TYPES 2N3418, 2N3419, 2N3420, 2N3421 N-P-N EPITAXIAL PLANAR SILICON MEDIUM-POWER TRANSISTORS

PARAMETER MEASUREMENT INFORMATION

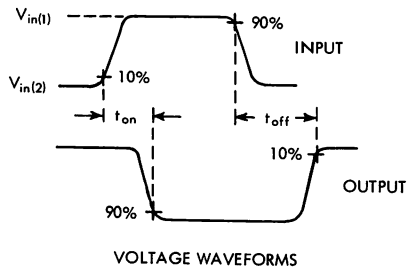
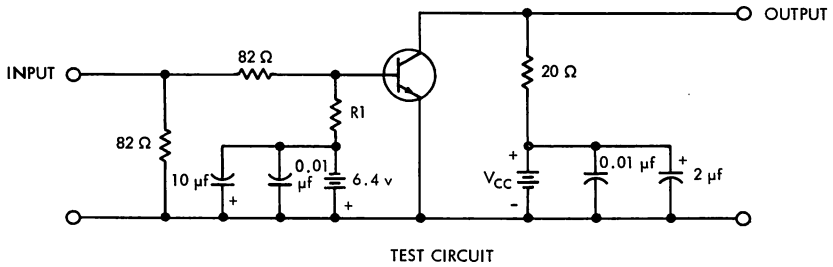

Nominal I_C	R_1	V_{CC}	$V_{in(1)}$	$V_{in(2)}$
1 a	82 Ω	20.3 v	+16.0 v	-1.0 v
2 a	41 Ω	40.5 v	+32.0 v	-1.3 v

CIRCUIT CONDITIONS

FIGURE 10

- NOTES: a. The input waveform is supplied by a generator with the following characteristics: $t_r \leq 15$ nsec, $t_f \leq 15$ nsec, $Z_{out} = 50 \Omega$, $PW = 2 \mu\text{sec}$, Duty Cycle $\leq 2\%$.
- b. Waveforms are monitored on an oscilloscope with the following characteristics: $t_r \leq 15$ nsec, $R_{in} \geq 10 \text{ M}\Omega$, $C_{in} \leq 11.5$ pf.
- c. Resistors must be non-inductive types.

TYPES 2N3418, 2N3419, 2N3420, 2N3421 N-P-N EPITAXIAL PLANAR SILICON MEDIUM-POWER TRANSISTORS

THERMAL INFORMATION

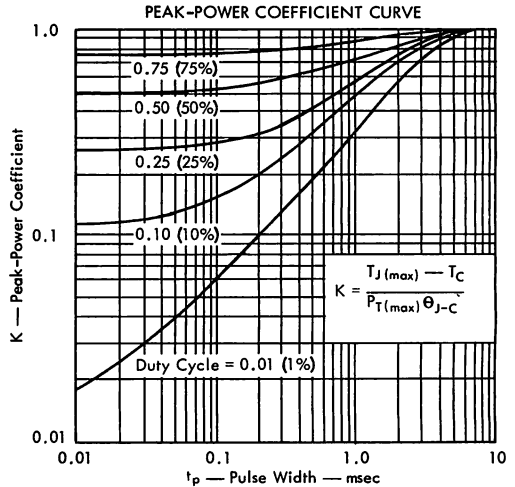
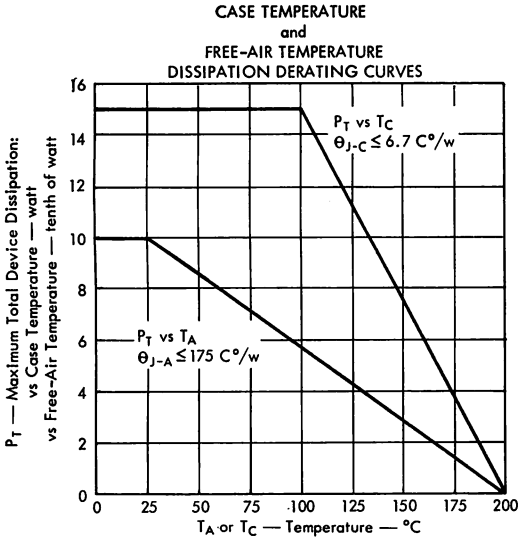

SYMBOL DEFINITION

SYMBOL	DEFINITION	VALUE	UNIT
$P_{T(av)}$	Average Power Dissipation		w
$P_{T(max)}$	Peak Power Dissipation		w
θ_{J-A}	Junction-to-Free-Air Thermal Resistance	175	$^{\circ}\text{C}/\text{w}$
θ_{J-C}	Junction-to-Case Thermal Resistance	6.67	$^{\circ}\text{C}/\text{w}$
θ_{C-A}	Case-to-Free-Air Thermal Resistance	168.33	$^{\circ}\text{C}/\text{w}$
θ_{C-HS}	Case-to-Heat Sink Thermal Resistance		$^{\circ}\text{C}/\text{w}$
θ_{HS-A}	Heat-Sink-to-Free-Air Thermal Resistance		$^{\circ}\text{C}/\text{w}$
T_A	Free-Air Temperature		$^{\circ}\text{C}$
T_C	Case Temperature		$^{\circ}\text{C}$
$T_{J(av)}$	Average Junction Temperature	≤ 200	$^{\circ}\text{C}$
$T_{J(max)}$	Peak Junction Temperature	≤ 200	$^{\circ}\text{C}$
K	Peak-Power Coefficient	See Figure 12	
t_p	Pulse Width		msec
t_x	Pulse Period		msec
d	Duty Cycle Ratio (t_p/t_x)		

Example — Find $P_{T(max)}$ (design limit)

OPERATING CONDITIONS:

$\theta_{C-HS} + \theta_{HS-A} = 7^{\circ}\text{C}/\text{w}$ (From information supplied with heat sink.)

$T_{J(av)}$ (design limit) = 200°C

$T_A = 50^{\circ}\text{C}$

d = 10% (0.1)

$t_p = 0.1$ msec

Equation No. 1 — Application: d-c power dissipation, heat sink used.

$$P_{T(av)} = \frac{T_{J(av)} - T_A}{\theta_{J-C} + \theta_{C-HS} + \theta_{HS-A}} \quad \text{for } 100^{\circ}\text{C} \leq T_C \leq 200^{\circ}\text{C}, \text{ as in Figure 11}$$

Equation No. 2 — Application: d-c power dissipation, no heat sink used.

$$P_{T(av)} = \frac{T_{J(av)} - T_A}{\theta_{J-A}} \quad \text{for } 25^{\circ}\text{C} \leq T_A \leq 200^{\circ}\text{C}, \text{ as in Figure 11}$$

Equation No. 3 — Application: Peak power dissipation, heat sink used.

$$P_{T(max)} = \frac{T_{J(max)} - T_A}{d(\theta_{C-HS} + \theta_{HS-A}) + K\theta_{J-C}} \quad \text{for } 100^{\circ}\text{C} \leq T_C \leq 200^{\circ}\text{C}$$

Equation No. 4 — Application: Peak power dissipation, no heat sink used.

$$P_{T(max)} = \frac{T_{J(max)} - T_A}{d\theta_{C-A} + K\theta_{J-C}} \quad \text{for } 25^{\circ}\text{C} \leq T_A \leq 200^{\circ}\text{C}$$

Solution:

From Figure 12, Peak-Power Coefficient

$K = 0.155$ and by use of equation No. 3

$$P_{T(max)} = \frac{T_{J(max)} - T_A}{d(\theta_{C-HS} + \theta_{HS-A}) + K\theta_{J-C}}$$

$$P_{T(max)} = \frac{200 - 50}{0.1(7) + 0.155(6.67)} = 86 \text{ w}$$

TYPES 2N3551, 2N3552 N-P-N TRIPLE-DIFFUSED MESA SILICON TRANSISTORS



THIN-PAC† HIGH-SPEED POWER SWITCH, ISOLATED COLLECTOR FORMERLY TIX210, TIX211

- 40 Watts at 100°C Case Temperature
- Maximum r_{CS} of 0.1 Ohm at 10 Amperes I_C
- Maximum V_{BE} of 1.4 Volts at 10 Amperes I_C
- Maximum t_{on} of 300 nsec

TYPES 2N3551, 2N3552
BULLETIN NO. DL-S 645883, AUGUST 1964
REPLACES BULLETIN NO. DL-S 634276, AUGUST 1963

mechanical data

These transistors are in precision welded, hermetically sealed enclosures. Extreme cleanliness during the assembly process prevents sealed-in contamination. The approximate unit weight is 3.8 grams.

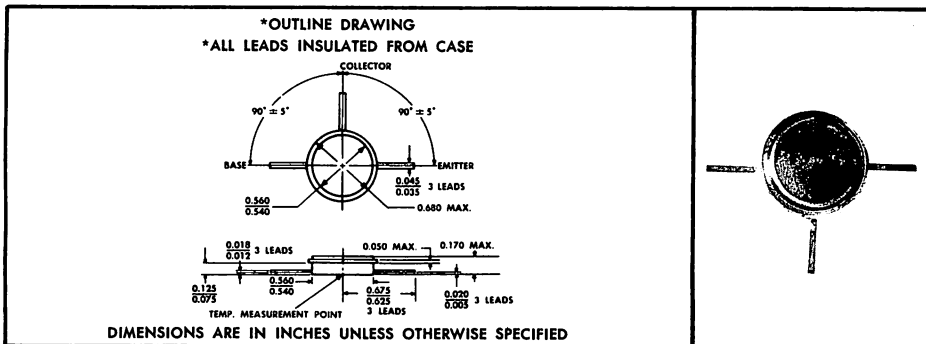

*absolute maximum ratings at 25°C case temperature (unless otherwise noted)

	2N3551	2N3552
Collector-Base Voltage	115 v	140 v
Collector-Emitter Voltage (See Note 1)	60 v	80 v
Emitter-Base Voltage	← 7 v →	← 7 v →
Continuous Collector Current	← 12 a →	← 12 a →
Continuous Base Current	← 5 a →	← 5 a →
Continuous Emitter Current	← 12 a →	← 12 a →
Safe Operating Region at 100°C Case Temperature	See Figures 3 and 4	
Continuous Device Dissipation at (or below) 25°C Free-Air Temperature (See Note 2)	← 1.2 w →	
Continuous Device Dissipation at (or below) 100°C Case Temperature (See Note 3)	← 40 w →	
Operating Collector Junction Temperature	← 175°C →	
Operating Case Temperature Range	← -65°C to + 175°C →	
Storage Temperature Range	← -65°C to + 200°C →	
Lead Temperature 1/16 Inch from Case for 12 Seconds	← 235°C →	

NOTES: 1. These values apply when the base-emitter diode is open-circuited.
2. Derate linearly to 175°C free-air temperature at the rate of 8 mw/°C.
3. Derate linearly to 175°C case temperature at the rate of 0.53 w/°C.

†Trademark of Texas Instruments.
*Indicates JEDEC registered data.

TYPES 2N3551, 2N3552

N-P-N TRIPLE-DIFFUSED MESA SILICON TRANSISTORS

*electrical characteristics at 25°C case temperature (unless otherwise noted)

PARAMETER	TEST CONDITIONS	2N3551		2N3552		UNIT
		MIN	MAX	MIN	MAX	
V_{CB0} Collector-Base Breakdown Voltage	$I_C = 10 \text{ ma}$, $I_E = 0$, See Note 4	115		140		v
V_{CE0} Collector-Emitter Breakdown Voltage	$I_C = 200 \text{ ma}$, $I_B = 0$, See Note 4	60		80		v
I_{CEV} Collector Cutoff Current	$V_{CE} = 110 \text{ v}$, $V_{BE} = -1.5 \text{ v}$	10				ma
	$V_{CE} = 135 \text{ v}$, $V_{BE} = -1.5 \text{ v}$			10		
	$V_{CE} = 60 \text{ v}$, $V_{BE} = -1.5 \text{ v}$, $T_C = 150^\circ\text{C}$	10				
	$V_{CE} = 80 \text{ v}$, $V_{BE} = -1.5 \text{ v}$, $T_C = 150^\circ\text{C}$			10		
I_{EBO} Emitter Cutoff Current	$V_{EB} = 5 \text{ v}$, $I_C = 0$			0.1	0.1	ma
	$V_{EB} = 7 \text{ v}$, $I_C = 0$			1	1	
h_{FE} Static Forward Current Transfer Ratio	$V_{CE} = 2 \text{ v}$, $I_C = 5 \text{ a}$, See Note 4	25		25		
	$V_{CE} = 2 \text{ v}$, $I_C = 10 \text{ a}$, See Note 4	20	90	20	90	
	$V_{CE} = 2 \text{ v}$, $I_C = 10 \text{ a}$, $T_C = -55^\circ\text{C}$, See Note 4	10		10		
V_{BE} Base-Emitter Voltage	$I_B = 0.5 \text{ a}$, $I_C = 5 \text{ a}$, See Note 4			1.2	1.2	v
	$I_B = 1 \text{ a}$, $I_C = 10 \text{ a}$, See Note 4			1.4	1.4	
$V_{CE(sat)}$ Collector-Emitter Saturation Voltage	$I_B = 0.5 \text{ a}$, $I_C = 5 \text{ a}$, See Note 4			0.5	0.5	v
	$I_B = 1 \text{ a}$, $I_C = 10 \text{ a}$, See Note 4			1.0	1.0	
$ h_{fe} $ Small-Signal Common-Emitter Forward Current Transfer Ratio	$V_{CE} = 10 \text{ v}$, $I_C = 3 \text{ a}$, $f = 10 \text{ Mc}$	4		4		
C_{ob} Common-Base Open-Circuit Output Capacitance	$V_{CB} = 10 \text{ v}$, $I_E = 0$, $f = 1 \text{ Mc}$	850		850		pf

NOTE 4: These parameters must be measured using pulse techniques. PW = 300 μsec , Duty Cycle $\leq 2\%$.

thermal characteristics

PARAMETER	MAX	UNIT
θ_{J-C} Junction-to-Case Thermal Resistance	1.875	$^\circ\text{C}/\text{w}$
θ_{J-A} Junction-to-Free-Air Thermal Resistance	125	$^\circ\text{C}/\text{w}$

*switching characteristics at 25°C case temperature

PARAMETER	TEST CONDITIONS‡	MAX	UNIT
t_{on} Turn-On Time	$I_C = 10 \text{ a}$, $I_{B(1)} = 1 \text{ a}$, $I_{B(2)} = -1 \text{ a}$	0.3	μsec
t_{off} Turn-Off Time	$V_{BE(off)} = -6 \text{ v}$, $R_L = 2.4\Omega$, See Figure 1	2.5	μsec

‡Voltage and current values shown are nominal; exact values vary slightly with device parameters.

*Indicates JEDEC Registered Data.

TYPES 2N3551, 2N3552 N-P-N TRIPLE-DIFFUSED MESA SILICON TRANSISTORS

PARAMETER MEASUREMENT INFORMATION

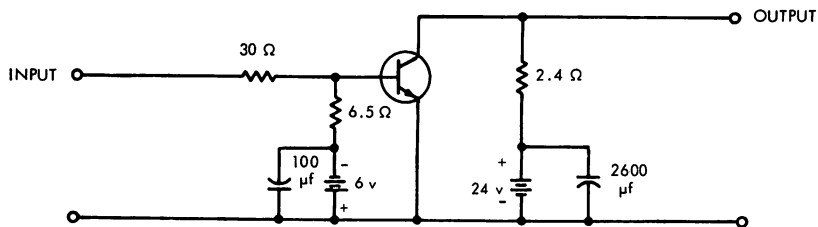

TEST CIRCUIT

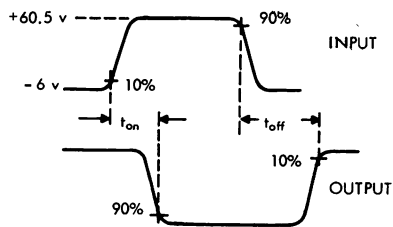

VOLTAGE WAVEFORMS

FIGURE 1

- NOTES:
- The input waveform is supplied by a generator with the following characteristics: $t_r \leq 20$ nsec, $t_f \leq 20$ nsec, $Z_{out} = 1500 \Omega$, $PW = 5 \mu\text{sec}$,
Duty Cycle $\leq 0.5\%$.
 - Waveforms are monitored on an oscilloscope with the following characteristics: $t_r \leq 5$ nsec, $R_{in} \geq 1 \text{ M}\Omega$, $C_{in} \leq 5$ pf.
 - Resistors must be noninductive types.

TYPES 2N3551, 2N3552

N-P-N TRIPLE-DIFFUSED MESA SILICON TRANSISTORS

THERMAL INFORMATION

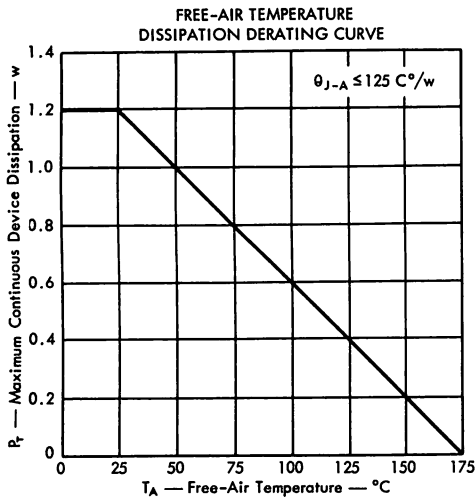

FIGURE 1

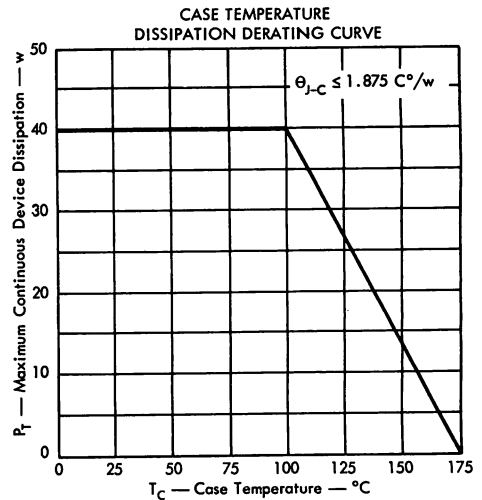

FIGURE 2

MAXIMUM SAFE OPERATING REGIONS

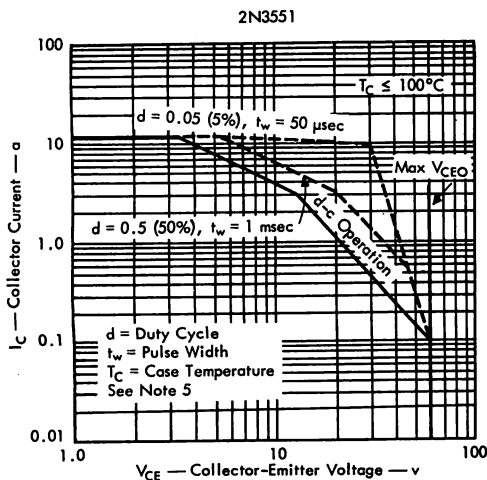

FIGURE 3

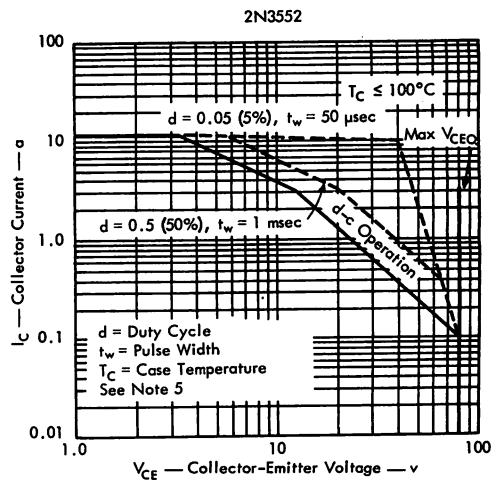

FIGURE 4

NOTE 5: Operation above maximum V_{CE0} is permissible if the base is reverse-voltage biased with respect to the emitter and the collector-base-voltage rating is not exceeded.

TYPES 2N3713, 2N3714, 2N3715, 2N3716 N-P-N SINGLE-DIFFUSED MESA SILICON POWER TRANSISTORS



TYPES 2N3713, 2N3714, 2N3715, 2N3716
BULLETIN NO. DL-5 6810691, FEBRUARY 1968

FOR POWER-AMPLIFIER AND SWITCHING APPLICATIONS

- 150 W at 25°C Case Temperature
- 10 A Rated Collector Current
- Min f_{hfe} of 30 kHz
- Min f_T of 4 MHz

*mechanical data

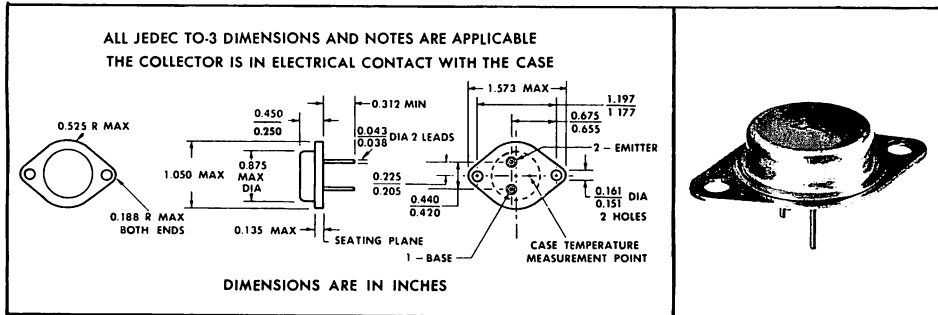

absolute maximum ratings at 25°C case temperature (unless otherwise noted)

	2N3713	2N3714	2N3715	2N3716
*Collector-Base Voltage	80 V	100 V	80 V	100 V
*Collector-Emitter Voltage (See Note 1)	60 V	80 V	60 V	80 V
*Emitter-Base Voltage	← 7 V →			
*Continuous Collector Current	← 10 A →			
Peak Collector Current (See Note 2)	← 15 A →			
*Continuous Base Current	← 4 A →			
*Safe Operating Region at (or below) 25°C Case Temperature	See Figures 8 and 9			
*Continuous Device Dissipation at (or below) 25°C Case Temperature (See Note 3)	← 150 W →			
Continuous Device Dissipation at (or below) 25°C Free-Air Temperature (See Note 4)	← 4 W →			
*Operating Collector Junction Temperature Range	← -65°C to 200°C →			
*Storage Temperature Range	← -65°C to 200°C →			
Lead Temperature 1/8 Inch from Case for 10 Seconds	← 235°C →			

- NOTES: 1. This value applies when the base-emitter diode is open-circuited.
 2. This value applies for $t_p = 0.3$ ms, duty cycle $\leq 10\%$.
 3. Derate linearly to 200°C case temperature at the rate of 0.855 W/deg.
 4. Derate linearly to 200°C free-air temperature at the rate of 22.9 mW/deg.

*Indicates JEDEC registered data



TEXAS INSTRUMENTS
INCORPORATED
POST OFFICE BOX 5012 • DALLAS, TEXAS 75222

16511

TYPES 2N3713, 2N3714, 2N3715, 2N3716

N-P-N SINGLE-DIFFUSED MESA SILICON POWER TRANSISTORS

*electrical characteristics at 25°C case temperature (unless otherwise noted)

PARAMETER	TEST CONDITIONS	2N3713	2N3714	2N3715	2N3716	UNIT	
		MIN MAX	MIN MAX	MIN MAX	MIN MAX		
$V_{(BR)CEO}$ Collector-Emitter Breakdown Voltage	$I_C = 200 \text{ mA}$, $I_B = 0$, See Note 5	60	80	60	80	V	
I_{CEO} Collector Cutoff Current	$V_{CE} = 30 \text{ V}$, $I_B = 0$	0.7		0.7		mA	
	$V_{CE} = 40 \text{ V}$, $I_B = 0$			0.7			
I_{CEV} Collector Cutoff Current	$V_{CE} = 80 \text{ V}$, $V_{BE} = -1.5 \text{ V}$	1		1		mA	
	$V_{CE} = 100 \text{ V}$, $V_{BE} = -1.5 \text{ V}$			1			
	$V_{CE} = 60 \text{ V}$, $V_{BE} = -1.5 \text{ V}$, $T_C = 150^\circ\text{C}$	10		10		mA	
	$V_{CE} = 80 \text{ V}$, $V_{BE} = -1.5 \text{ V}$, $T_C = 150^\circ\text{C}$			10			
I_{EBO} Emitter Cutoff Current	$V_{EB} = 7 \text{ V}$, $I_C = 0$	1	1	1	1	mA	
h_{FE} Static Forward Current Transfer Ratio	$V_{CE} = 2 \text{ V}$, $I_C = 1 \text{ A}$, See Notes 5 and 6	25	75	25	75		
	$V_{CE} = 2 \text{ V}$, $I_C = 3 \text{ A}$, See Notes 5 and 6	15		30			
	$V_{CE} = 4 \text{ V}$, $I_C = 10 \text{ A}$, See Notes 5 and 6	5		5			
V_{BE} Base-Emitter Voltage	$V_{CE} = 2 \text{ V}$, $I_C = 5 \text{ A}$, See Notes 5 and 6	2		1.8		V	
	$V_{CE} = 4 \text{ V}$, $I_C = 10 \text{ A}$, See Notes 5 and 6	4		4			
$V_{CE(sat)}$ Collector-Emitter Saturation Voltage	$I_B = 0.5 \text{ A}$, $I_C = 5 \text{ A}$, See Notes 5 and 6	1		0.8		V	
	$I_B = 2 \text{ A}$, $I_C = 10 \text{ A}$, See Notes 5 and 6	4		4			
h_{fo} Small-Signal Common-Emitter Forward Current Transfer Ratio	$V_{CE} = 10 \text{ V}$, $I_C = 0.5 \text{ A}$, $f = 1 \text{ kHz}$	25	250	25	250	25	250
$ h_{fo} $ Small-Signal Common-Emitter Forward Current Transfer Ratio	$V_{CE} = 10 \text{ V}$, $I_C = 0.5 \text{ A}$, $f = 1 \text{ MHz}$	4		4		4	
f_{hfo} Small-Signal Common-Emitter Forward Current Transfer Ratio Cutoff Frequency	$V_{CE} = 10 \text{ V}$, $I_C = 0.5 \text{ A}$	30		30		30	
C_{obo} Common-Base Open-Circuit Output Capacitance	$V_{CB} = 10 \text{ V}$, $I_E = 0$, $f = 100 \text{ kHz}$	250		250		250	

NOTES: 5. These parameters must be measured using pulse techniques. $t_p = 300 \mu\text{s}$, duty cycle $\leq 2\%$.

6. These parameters are measured with voltage-sensing contacts separate from the current-carrying contacts.

thermal characteristics

PARAMETER	MAX	UNIT
θ_{J-C} Junction-to-Case Thermal Resistance	1.17	deg/W
θ_{J-A} Junction-to-Free-Air Thermal Resistance	43.7	

*Indicates JEDEC registered data

TYPES 2N3713, 2N3714, 2N3715, 2N3716

N-P-N SINGLE-DIFFUSED MESA SILICON POWER TRANSISTORS

switching characteristics at 25°C case temperature

PARAMETER	TEST CONDITIONS†	TYP	UNIT
t_{on} Turn-On Time	$I_C = 1 \text{ A}$, $I_{B(1)} = 100 \text{ mA}$, $I_{B(2)} = -100 \text{ mA}$, $V_{BE(off)} = -3.7 \text{ V}$, $R_L = 20 \Omega$, See Figure 1	450	ns
t_{off} Turn-Off Time		350	

†Voltage and current values shown are nominal; exact values vary slightly with transistor parameters.

PARAMETER MEASUREMENT INFORMATION

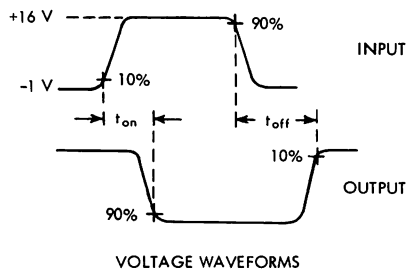
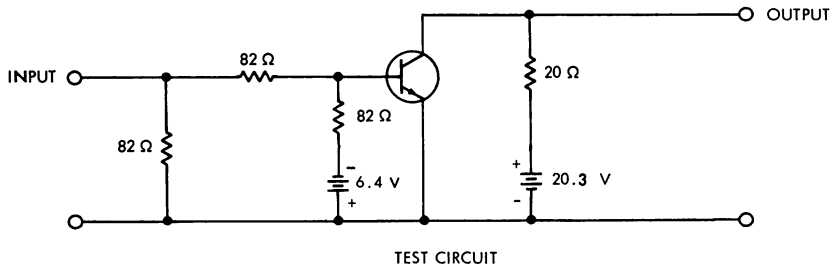

FIGURE 1

- NOTES:
- The input waveform is supplied by a generator with the following characteristics: $t_r \leq 15 \text{ ns}$, $t_f \leq 15 \text{ ns}$, $Z_{out} = 50 \Omega$, $t_p = 10 \mu\text{s}$, duty cycle $\leq 2\%$.
 - Waveforms are monitored on an oscilloscope with the following characteristics: $t_r \leq 15 \text{ ns}$, $R_{in} \geq 10 \text{ M}\Omega$, $C_{in} \leq 11.5 \text{ pF}$.
 - Resistors must be noninductive types.
 - The d-c power supplies may require additional bypassing in order to minimize ringing.

TYPES 2N3713, 2N3714, 2N3715, 2N3716

N-P-N SINGLE-DIFFUSED MESA SILICON POWER TRANSISTORS

TYPICAL CHARACTERISTICS

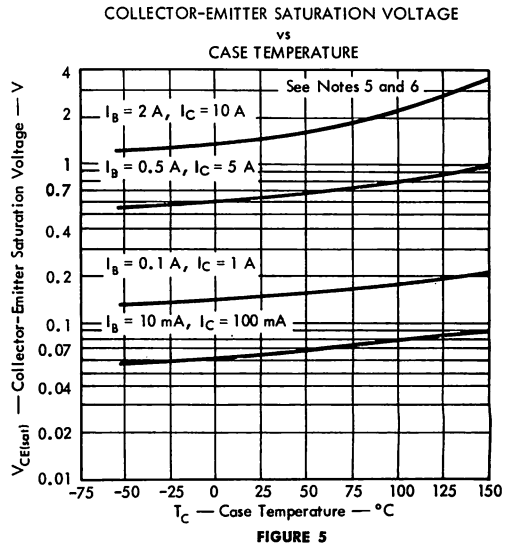
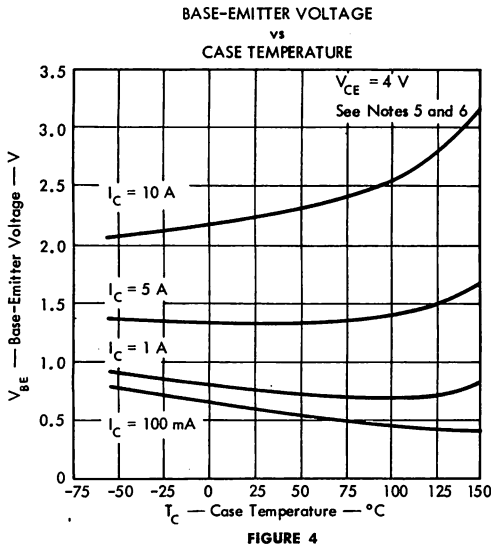
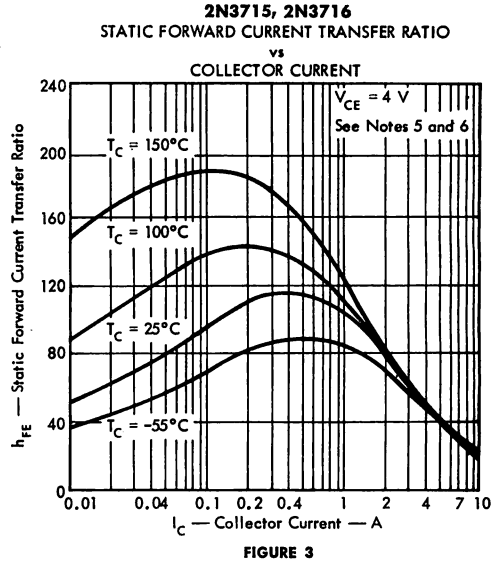
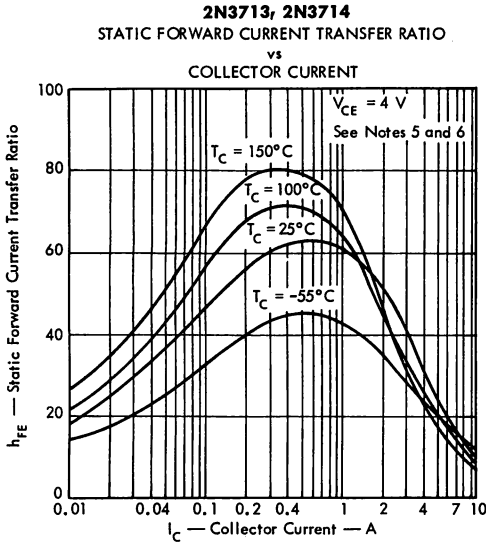

NOTES: 5. These parameters must be measured using pulse techniques. $t_p = 300\ \mu\text{s}$, duty cycle $\leq 2\%$.

6. These parameters are measured with voltage-sensing contacts separate from the current-carrying contacts.

TYPES 2N3713, 2N3714, 2N3715, 2N3716

N-P-N SINGLE-DIFFUSED MESA SILICON POWER TRANSISTORS

TYPICAL CHARACTERISTICS

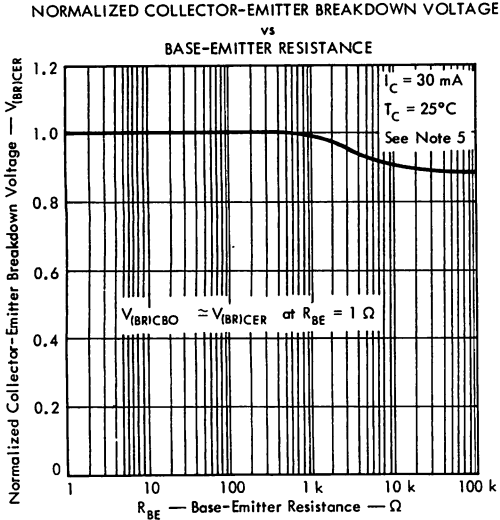

FIGURE 6

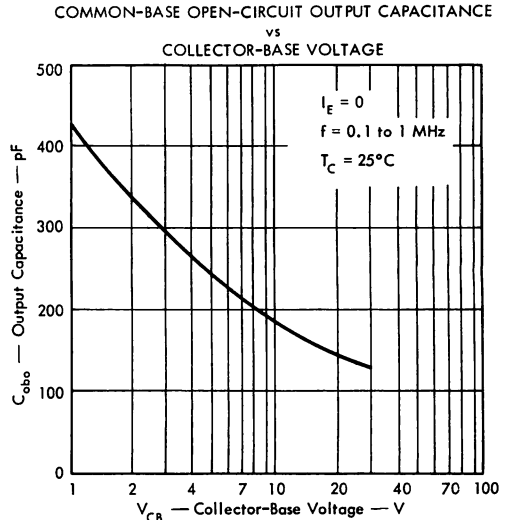

FIGURE 7

MAXIMUM SAFE OPERATING REGIONS

2N3713, 2N3715

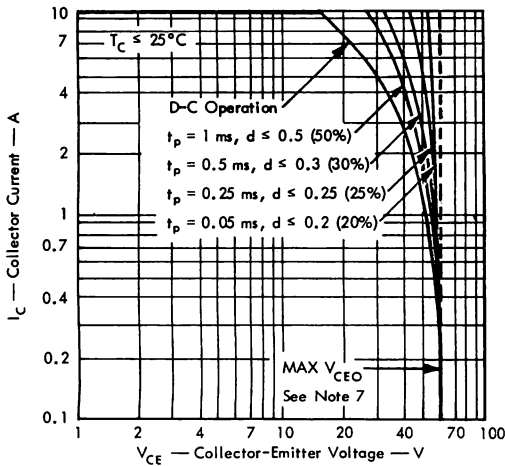

FIGURE 8

2N3714, 2N3716

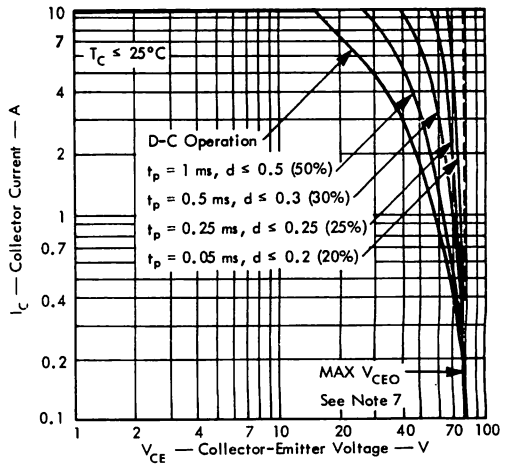

FIGURE 9

NOTES: 5. This parameter must be measured using pulse techniques. $t_p = 300 \mu\text{s}$, duty cycle $\leq 2\%$.

7. Operation above maximum V_{CEO} is permissible if the base is reverse-voltage biased with respect to the emitter and the collector-base-voltage rating is not exceeded.

TYPES 2N3713, 2N3714, 2N3715, 2N3716

N-P-N SINGLE-DIFFUSED MESA SILICON POWER TRANSISTORS

THERMAL INFORMATION

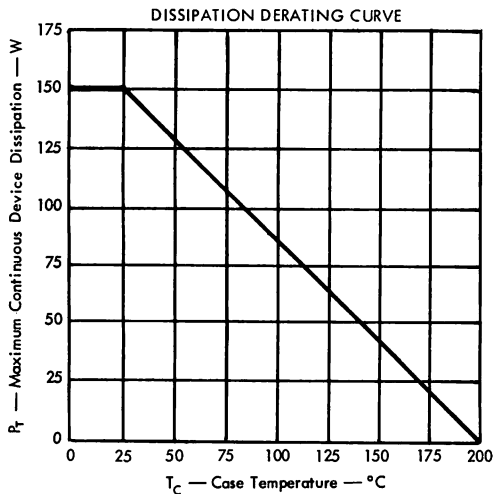

FIGURE 10

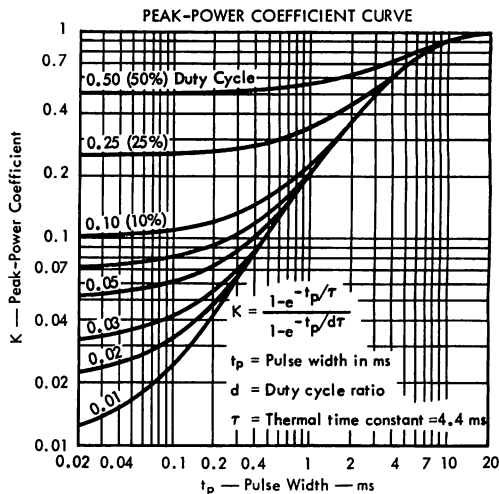

FIGURE 11

SYMBOL DEFINITION

SYMBOL	DEFINITION	VALUE	UNIT
$P_{T(av)}$	Average Power Dissipation		W
$P_{T(max)}$	Peak Power Dissipation		W
θ_{J-A}	Junction-to-Free-Air Thermal Resistance	43.7	deg/W
θ_{J-C}	Junction-to-Case Thermal Resistance	1.17	deg/W
θ_{C-A}	Case-to-Free-Air Thermal Resistance	42.5	deg/W
θ_{C-HS}	Case-to-Heat-Sink Thermal Resistance		deg/W
θ_{HS-A}	Heat-Sink-to-Free-Air Thermal Resistance		deg/W
T_A	Free-Air Temperature		°C
T_C	Case Temperature		°C
$T_{J(av)}$	Average Junction Temperature	≤ 200	°C
$T_{J(max)}$	Peak Junction Temperature	≤ 200	°C
K	Peak-Power Coefficient	See Figure 11	
t_p	Pulse Width		ms
t_x	Pulse Period		ms
d	Duty Cycle Ratio (t_p/t_x)		

Example — Find $P_{T(max)}$ (design limit)

OPERATING CONDITIONS:

$$\theta_{C-HS} + \theta_{HS-A} = 2.25 \text{ deg/W (From information supplied with heat sink.)}$$

$$T_{J(av)} \text{ (design limit)} = 200^\circ\text{C}$$

$$T_A = 50^\circ\text{C}$$

$$d = 10\% \text{ (0.1)}$$

$$t_p = 0.1 \text{ ms}$$

Equation No. 1 — Application: d-c power dissipation, heat sink used.

$$P_{T(av)} = \frac{T_{J(av)} - T_A}{\theta_{J-C} + \theta_{C-HS} + \theta_{HS-A}} \text{ for } 25^\circ\text{C} \leq T_C \leq 200^\circ\text{C, as in figure 10.}$$

Equation No. 2 — Application: d-c power dissipation, no heat sink used.

$$P_{T(av)} = \frac{T_{J(av)} - T_A}{\theta_{J-A}} \text{ for } 25^\circ\text{C} \leq T_A \leq 200^\circ\text{C}$$

Equation No. 3 — Application: Peak power dissipation, heat sink used.

$$P_{T(max)} = \frac{T_{J(max)} - T_A}{d(\theta_{C-HS} + \theta_{HS-A}) + K\theta_{J-C}} \text{ for } 25^\circ\text{C} \leq T_C \leq 200^\circ\text{C}$$

Equation No. 4 — Application: Peak power dissipation, no heat sink used.

$$P_{T(max)} = \frac{T_{J(max)} - T_A}{d\theta_{C-A} + K\theta_{J-C}} \text{ for } 25^\circ\text{C} \leq T_A \leq 200^\circ\text{C}$$

Solution:

From figure 11, Peak-Power Coefficient

$$K = 0.11 \text{ and by use of equation No. 3}$$

$$P_{T(max)} = \frac{T_{J(max)} - T_A}{d(\theta_{C-HS} + \theta_{HS-A}) + K\theta_{J-C}}$$

$$P_{T(max)} = \frac{200 - 50}{0.1(2.25) + 0.11(1.17)} = 424 \text{ W}$$

TYPES 2N3996, 2N3997, 2N3998, 2N3999 N-P-N EPITAXIAL PLANAR SILICON POWER TRANSISTORS



TYPES 2N3996, 2N3997, 2N3998, 2N3999
BULLETIN NO. DL-5 668237, MARCH 1966

FOR HIGH-SPEED POWER SWITCHING APPLICATIONS

- 30 W at 100°C Case Temperature
- Isolated-Stud Package (2N3996, 2N3997)
- Max $V_{CE(sat)}$ of 0.25 V at 1 A I_C
- Max t_{on} of 300 ns at 1 A I_C
- Min f_T of 40 MHz

*mechanical data

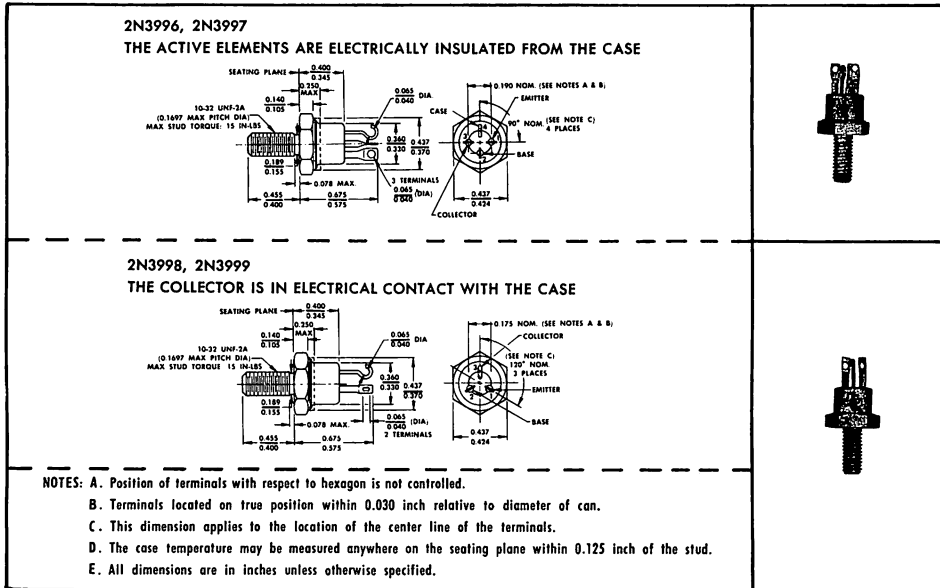

*absolute maximum ratings at 25°C case temperature (unless otherwise noted)

Collector-Base Voltage	100 V
Collector-Emitter Voltage (See Note 1)	80 V
Emitter-Base Voltage	8 V
Continuous Collector Current	5 A
Peak Collector Current (See Note 2)	10 A
Continuous Base Current	1 A
Safe Operating Region at (or below) 100°C Case Temperature	See Figure 8
Continuous Device Dissipation at (or below) 100°C Case Temperature (See Note 3)	30 W
Continuous Device Dissipation at (or below) 25°C Free-Air Temperature (See Note 4)	2 W
Operating Collector Junction Temperature Range	-65°C to 200°C
Storage Temperature Range	-65°C to 200°C
Lead Temperature 1/16 Inch from Case for 10 Seconds	230°C

- NOTES: 1. This value applies when the base-emitter diode is open-circuited.
 2. This value applies for $t_p \leq 1$ ms, duty cycle $\leq 50\%$.
 3. Derate linearly to 200°C case temperature at the rate of 0.3 W/deg.
 4. Derate linearly to 200°C free-air temperature at the rate of 11.4 mW/deg.

*Indicates JEDEC registered data.

TYPES 2N3996, 2N3997, 2N3998, 2N3999

N-P-N EPITAXIAL PLANAR SILICON POWER TRANSISTORS

*electrical characteristics at 25°C case temperature (unless otherwise noted)

PARAMETER	TEST CONDITIONS	2N3996 2N3998		2N3997 2N3999		UNIT
		MIN	MAX	MIN	MAX	
$V_{(BR)CEO}$ Collector-Emitter Breakdown Voltage	$I_C = 50 \text{ mA}$, $I_B = 0$, See Note 5	80		80		V
I_{CEO} Collector Cutoff Current	$V_{CE} = 60 \text{ V}$, $I_B = 0$	10		10		μA
I_{CES} Collector Cutoff Current	$V_{CE} = 90 \text{ V}$, $V_{BE} = 0$	5		5		μA
	$V_{CE} = 90 \text{ V}$, $V_{BE} = 0$, $T_C = 150^\circ\text{C}$	50		50		
I_{EBO} Emitter Cutoff Current	$V_{EB} = 5 \text{ V}$, $I_C = 0$	0.5		0.5		μA
	$V_{EB} = 8 \text{ V}$, $I_C = 0$	10		10		
h_{FE} Static Forward Current Transfer Ratio	$V_{CE} = 2 \text{ V}$, $I_C = 50 \text{ mA}$	30		60		
	$V_{CE} = 2 \text{ V}$, $I_C = 1 \text{ A}$, See Note 5	40	120	80	240	
	$V_{CE} = 5 \text{ V}$, $I_C = 5 \text{ A}$, See Note 5	15		20		
	$V_{CE} = 2 \text{ V}$, $I_C = 1 \text{ A}$, $T_C = -55^\circ\text{C}$, See Note 5	10		20		
V_{BE} Base-Emitter Voltage	$I_B = 100 \text{ mA}$, $I_C = 1 \text{ A}$, See Note 5	0.6	1.2	0.6	1.2	V
	$I_B = 500 \text{ mA}$, $I_C = 5 \text{ A}$, See Note 5		1.6		1.6	
$V_{CE(sat)}$ Collector-Emitter Saturation Voltage	$I_B = 100 \text{ mA}$, $I_C = 1 \text{ A}$, See Note 5	0.25		0.25		V
	$I_B = 500 \text{ mA}$, $I_C = 5 \text{ A}$, See Note 5		2		2	
$ h_{fo} $ Small-Signal Common-Emitter Forward Current Transfer Ratio	$V_{CE} = 5 \text{ V}$, $I_C = 1 \text{ A}$, $f = 10 \text{ MHz}$	4		4		
C_{obo} Common-Base Open-Circuit Output Capacitance	$V_{CB} = 10 \text{ V}$, $I_E = 0$, $f = 1 \text{ MHz}$	150		150		pF

NOTE 5: This parameter must be measured using pulse techniques: $t_p = 300 \mu\text{s}$, duty cycle $\leq 2\%$.

* thermal characteristics

PARAMETER	MAX	UNIT
θ_{J-C} Junction-to-Case Thermal Resistance	3.33	deg/W
θ_{J-A} Junction-to-Free-Air Thermal Resistance	87.5	deg/W

*switching characteristics at 25°C case temperature

PARAMETER	TEST CONDITIONS†	2N3996 2N3998	2N3997 2N3999	UNIT
		MAX	MAX	
t_{on} Turn-On Time	$I_C = 1 \text{ A}$, $I_{B(1)} = 100 \text{ mA}$, $I_{B(2)} = -100 \text{ mA}$, $V_{BE(off)} = -3.7 \text{ V}$, $R_L = 20 \Omega$, See Figure 1	0.3	0.3	μs
t_{off} Turn-Off Time		1.5	2	

†Voltage and current values shown are nominal; exact values vary slightly with transistor parameters.

*Indicates JEDEC registered data.

TYPES 2N3996, 2N3997, 2N3998, 2N3999 N-P-N EPITAXIAL PLANAR SILICON POWER TRANSISTORS

*PARAMETER MEASUREMENT INFORMATION

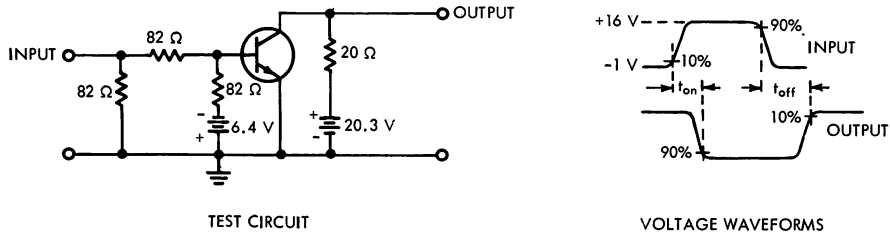

FIGURE 1

- NOTES: a. The input waveform is supplied by a generator with the following characteristics: $t_r \leq 15$ ns, $t_f \leq 15$ ns, $Z_{out} = 50 \Omega$, $t_p = 2 \mu s$, duty cycle $\leq 2\%$.
- b. Waveforms are monitored on an oscilloscope with the following characteristics: $t_r \leq 15$ ns, $R_{in} \geq 10$ M Ω , $C_{in} \leq 11.5$ pF.
- c. Resistors must be noninductive types.
- d. The d-c power supplies may require additional bypassing in order to minimize ringing.

TYPICAL CHARACTERISTICS

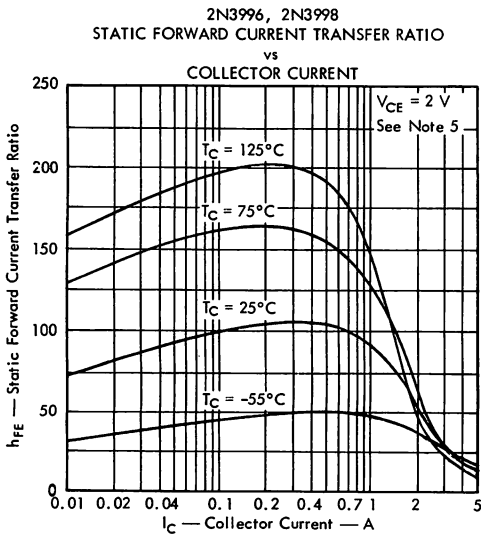

FIGURE 2

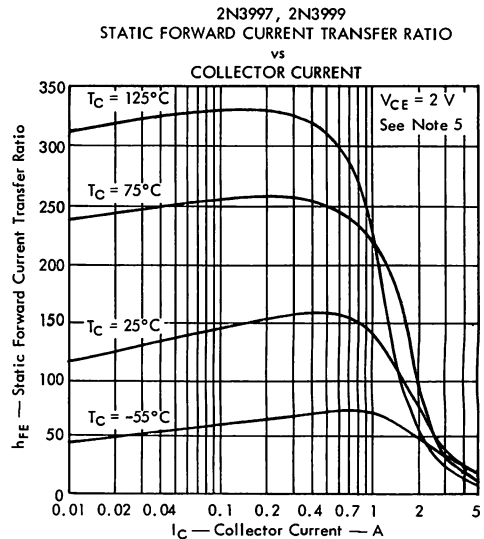

FIGURE 3

NOTE 5: This parameter must be measured using pulse techniques: $t_p = 300 \mu s$, duty cycle $\leq 2\%$.
*Indicates JEDEC registered data.

TYPES 2N3996, 2N3997, 2N3998, 2N3999

N-P-N EPITAXIAL PLANAR SILICON POWER TRANSISTORS

TYPICAL CHARACTERISTICS

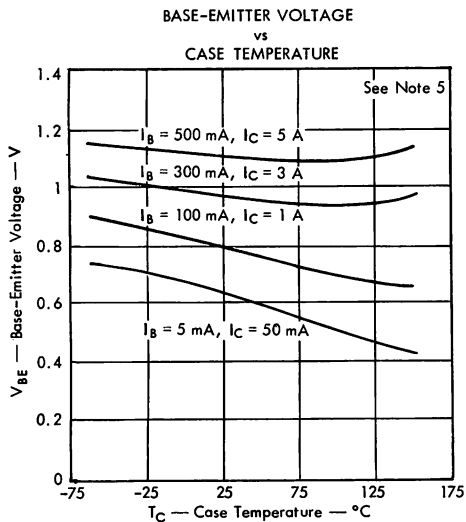

FIGURE 4

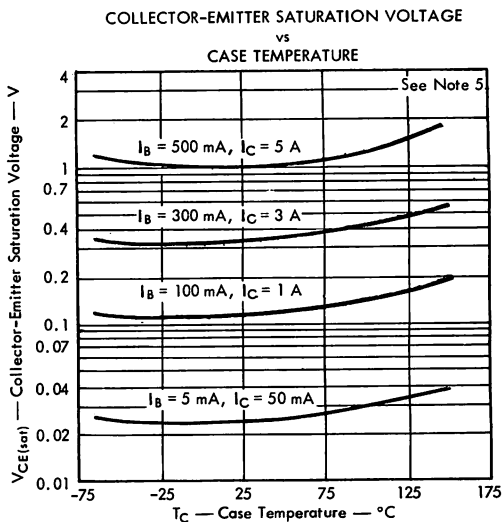

FIGURE 5

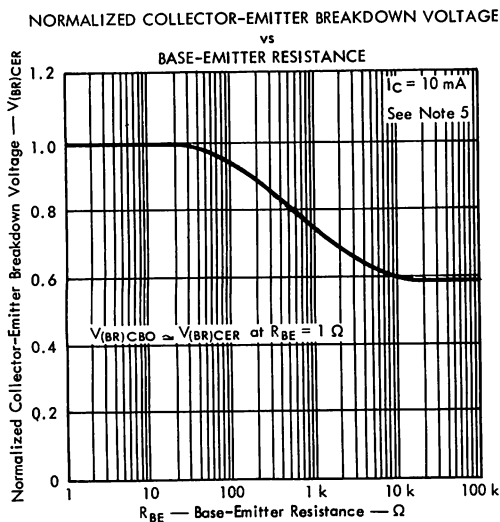

FIGURE 6

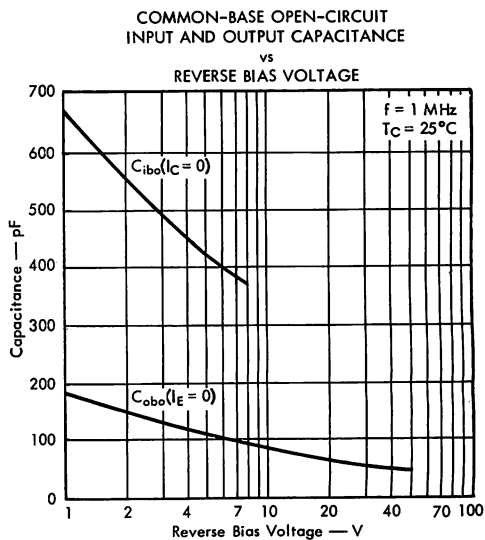

FIGURE 7

NOTE 5: This parameter must be measured using pulse techniques: $t_p = 300 \mu\text{s}$, duty cycle $\leq 2\%$.

TYPES 2N3996, 2N3997, 2N3998, 2N3999 N-P-N EPITAXIAL PLANAR SILICON POWER TRANSISTORS

MAXIMUM SAFE OPERATING REGION

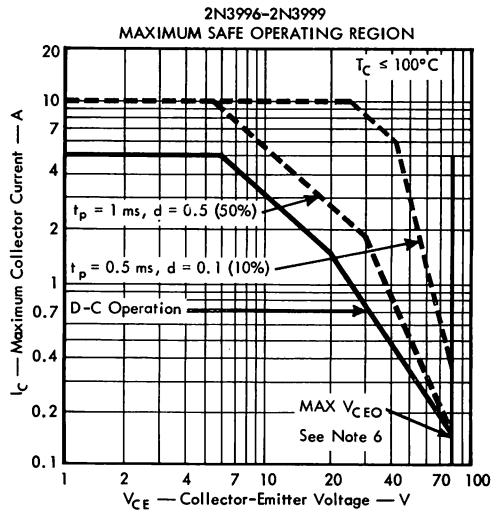

FIGURE 8

NOTE 6: Operation above maximum V_{CEO} is permissible if the base is reverse-voltage-biased with respect to the emitter and the collector-base voltage rating is not exceeded.

TYPES 2N3996, 2N3997, 2N3998, 2N3999

N-P-N EPITAXIAL PLANAR SILICON POWER TRANSISTORS

THERMAL INFORMATION

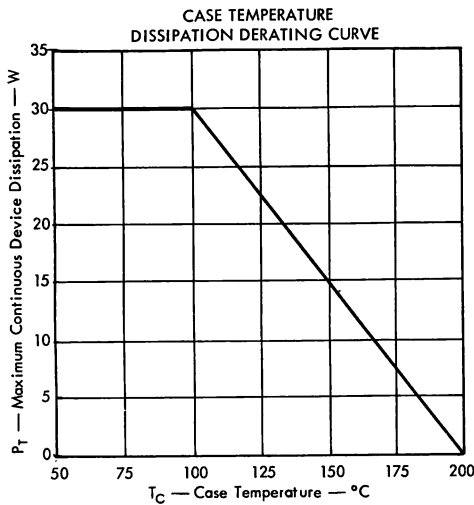

FIGURE 9

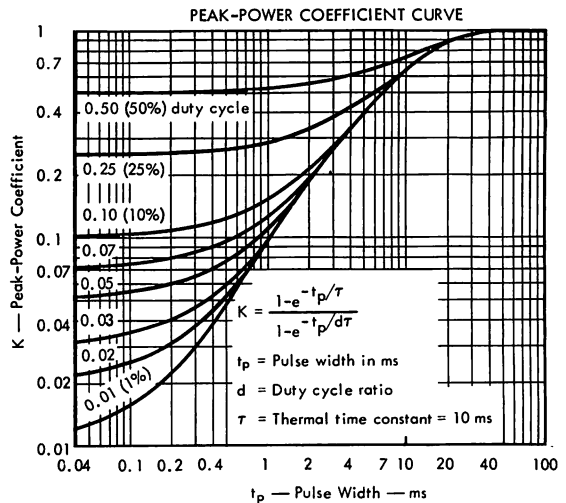

FIGURE 10

SYMBOL DEFINITION

SYMBOL	DEFINITION	VALUE	UNIT
$P_{T(avg)}$	Average Power Dissipation		W
$P_{T(max)}$	Peak Power Dissipation		W
θ_{J-A}	Junction-to-Free-Air Thermal Resistance	87.5	deg/W
θ_{J-C}	Junction-to-Case Thermal Resistance	3.33	deg/W
θ_{C-A}	Case-to-Free-Air Thermal Resistance	84.17	deg/W
θ_{C-HS}	Case-to-Heat-Sink Thermal Resistance		deg/W
θ_{HS-A}	Heat-Sink-to-Free-Air Thermal Resistance		deg/W
T_A	Free-Air Temperature		°C
T_C	Case Temperature		°C
$T_{J(avg)}$	Average Junction Temperature	≤ 200	°C
$T_{J(max)}$	Peak Junction Temperature	≤ 200	°C
K	Peak-Power Coefficient	See Figure 10	
t_p	Pulse Width		ms
t_x	Pulse Period		ms
d	Duty Cycle Ratio (t_p/t_x)		

Example — Find $P_{T(max)}$ (design limit)

OPERATING CONDITIONS:

$\theta_{C-HS} + \theta_{HS-A} = 7$ deg/W (From information supplied with heat sink.)

$T_{J(avg)}$ (design limit) = 200°C

$T_A = 50^\circ\text{C}$

d = 10% (0.1)

$t_p = 0.1$ ms

Equation No. 1 — Application: d-c power dissipation, heat sink used.

$$P_{T(avg)} = \frac{T_{J(avg)} - T_A}{\theta_{J-C} + \theta_{C-HS} + \theta_{HS-A}} \text{ for } 100^\circ\text{C} \leq T_C \leq 200^\circ\text{C} \text{ as in Figure 9}$$

Equation No. 2 — Application: d-c power dissipation, no heat sink used.

$$P_{T(avg)} = \frac{T_{J(avg)} - T_A}{\theta_{J-A}} \text{ for } 25^\circ\text{C} \leq T_A \leq 200^\circ\text{C}$$

Equation No. 3 — Application: Peak power dissipation, heat sink used.

$$P_{T(max)} = \frac{T_{J(max)} - T_A}{d(\theta_{C-HS} + \theta_{HS-A}) + K\theta_{J-C}} \text{ for } 100^\circ\text{C} \leq T_C \leq 200^\circ\text{C}$$

Equation No. 4 — Application: Peak power dissipation, no heat sink used.

$$P_{T(max)} = \frac{T_{J(max)} - T_A}{d\theta_{C-A} + K\theta_{J-C}} \text{ for } 25^\circ\text{C} \leq T_A \leq 200^\circ\text{C}$$

Solution:

From Figure 10, Peak-Power Coefficient

K = 0.103 and by use of equation No. 3

$$P_{T(max)} = \frac{T_{J(max)} - T_A}{d(\theta_{C-HS} + \theta_{HS-A}) + K\theta_{J-C}}$$

$$P_{T(max)} = \frac{200 - 50}{0.1(7) + (0.103)3.33} = 143 \text{ W}$$

TYPES 2N4000, 2N4001 N-P-N EPITAXIAL PLANAR SILICON POWER TRANSISTORS



TYPES 2N4000, 2N4001
BULLETIN NO. DL-5 668214, MARCH 1966

FOR HIGH-SPEED POWER SWITCHING APPLICATIONS

- 15 W at 100°C Case Temperature
- Max $V_{CE(sat)}$ of 0.3 V at 0.5 A I_C
- Max t_{on} of 300 ns at 0.5 A I_C
- Min f_T of 40 MHz

*mechanical data

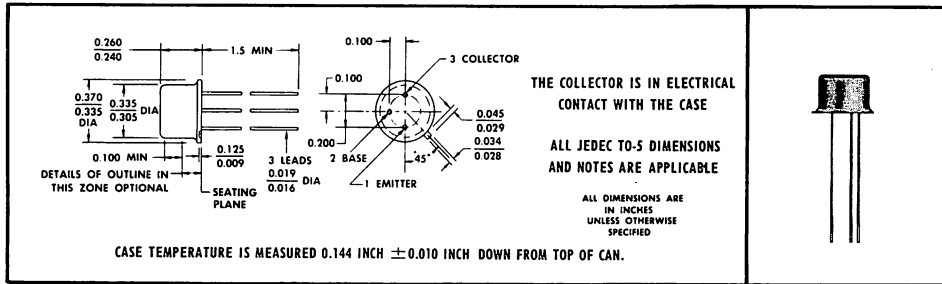

*absolute maximum ratings at 25°C case temperature (unless otherwise noted)

	2N4000	2N4001
Collector-Base Voltage	100 V	120 V
Collector-Emitter Voltage (See Note 1)	80 V	100 V
Emitter-Base Voltage	← 8 V →	
Continuous Collector Current	← 1 A →	
Peak Collector Current (See Note 2)	← 3 A →	
Continuous Base Current	← 0.5 A →	
Safe Operating Region at (or below) 100°C Case Temperature	See Figure 8	
Continuous Device Dissipation at (or below) 100°C Case Temperature (See Note 3)	← 15 W →	
Continuous Device Dissipation at (or below) 25°C Free-Air Temperature (See Note 4)	← 1 W →	
Operating Collector Junction Temperature Range	-65°C to 200°C	
Storage Temperature Range	-65°C to 200°C	
Lead Temperature 1/8 Inch from Case for 10 Seconds	← 230°C →	

- NOTES: 1. These values apply when the base-emitter diode is open-circuited.
 2. This value applies for $t_p \leq 1$ ms, duty cycle $\leq 50\%$.
 3. Derate linearly to 200°C case temperature at the rate of 0.15 W/deg.
 4. Derate linearly to 200°C free-air temperature at the rate of 5.72 mW/deg.

*Indicates JEDEC registered data.



TEXAS INSTRUMENTS
INCORPORATED
POST OFFICE BOX 5012 • DALLAS, TEXAS 75222

16607

TYPES 2N4000, 2N4001

N-P-N EPITAXIAL PLANAR SILICON POWER TRANSISTORS

*electrical characteristics at 25°C case temperature (unless otherwise noted)

PARAMETER	TEST CONDITIONS	2N4000		2N4001		UNIT
		MIN	MAX	MIN	MAX	
$V_{(BR)CEO}$ Collector-Emitter Breakdown Voltage	$I_C = 30 \text{ mA}$, $I_B = 0$, See Note 5	80		100		V
I_{CEO} Collector Cutoff Current	$V_{CE} = 60 \text{ V}$, $I_B = 0$	10				μA
	$V_{CE} = 80 \text{ V}$, $I_B = 0$			10		
I_{CES} Collector Cutoff Current	$V_{CE} = 90 \text{ V}$, $V_{BE} = 0$	2				μA
	$V_{CE} = 110 \text{ V}$, $V_{BE} = 0$			2		
	$V_{CE} = 90 \text{ V}$, $V_{BE} = 0$, $T_C = 150^\circ\text{C}$	50				
	$V_{CE} = 110 \text{ V}$, $V_{BE} = 0$, $T_C = 150^\circ\text{C}$			50		
I_{EBO} Emitter Cutoff Current	$V_{EB} = 5 \text{ V}$, $I_C = 0$	500		500		nA
	$V_{EB} = 8 \text{ V}$, $I_C = 0$	10		10		μA
h_{FE} Static Forward Current Transfer Ratio	$V_{CE} = 2 \text{ V}$, $I_C = 50 \text{ mA}$	10		20		
	$V_{CE} = 2 \text{ V}$, $I_C = 0.5 \text{ A}$, See Note 5	30	120	40	120	
	$V_{CE} = 5 \text{ V}$, $I_C = 1 \text{ A}$, See Note 5	10		20		
	$V_{CE} = 2 \text{ V}$, $I_C = 0.5 \text{ A}$, $T_C = -55^\circ\text{C}$, See Note 5	10		15		
V_{BE} Base-Emitter Voltage	$I_B = 50 \text{ mA}$, $I_C = 0.5 \text{ A}$, See Note 5	1		1		V
	$I_B = 100 \text{ mA}$, $I_C = 1 \text{ A}$, See Note 5	1.2		1.2		
$V_{CE(sat)}$ Collector-Emitter Saturation Voltage	$I_B = 50 \text{ mA}$, $I_C = 0.5 \text{ A}$, See Note 5	0.3		0.3		V
	$I_B = 100 \text{ mA}$, $I_C = 1 \text{ A}$, See Note 5	0.5		0.5		
$ h_{fe} $ Small-Signal Common-Emitter Forward Current Transfer Ratio	$V_{CE} = 5 \text{ V}$, $I_C = 0.5 \text{ A}$, $f = 20 \text{ MHz}$	2		2		
C_{obo} Common-Base Open-Circuit Output Capacitance	$V_{CB} = 10 \text{ V}$, $I_E = 0$, $f = 1 \text{ MHz}$	60		60		pF

NOTE 5: These parameters must be measured using pulse techniques. $t_p = 300 \mu\text{s}$, duty cycle $\leq 2\%$.

*thermal characteristics

PARAMETER	MAX	UNIT
θ_{J-C} Junction-to-Case Thermal Resistance	6.67,	deg/W
θ_{J-A} Junction-to-Free-Air Thermal Resistance	175	

*switching characteristics at 25°C case temperature

PARAMETER	TEST CONDITIONS†	MAX	UNIT
t_{on} Turn-On Time	$I_C = 0.5 \text{ A}$, $I_{B(1)} = 50 \text{ mA}$, $I_{B(2)} = -50 \text{ mA}$,	0.3	μs
t_{off} Turn-Off Time	$V_{BE(off)} = -4 \text{ V}$, $R_L = 20 \Omega$, See Figure 1	2	

†Voltage and current values shown are nominal; exact values vary slightly with transistor parameters.

*Indicates JEDEC registered data.

TYPES 2N4000, 2N4001 N-P-N EPITAXIAL PLANAR SILICON POWER TRANSISTORS

PARAMETER MEASUREMENT INFORMATION

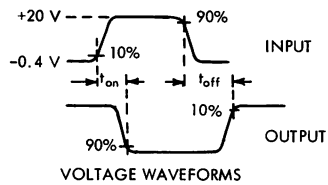
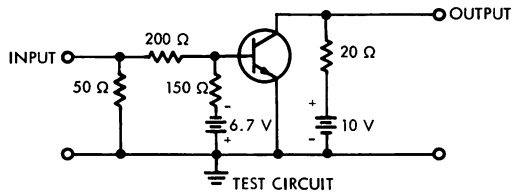

FIGURE 1

- NOTES: a. The input waveform is supplied by a generator with the following characteristics: $t_r \leq 10$ ns, $t_f \leq 10$ ns, $Z_{out} = 50 \Omega$, $t_p = 10 \mu s$, duty cycle $\leq 2\%$.
- b. Waveforms are monitored on an oscilloscope with the following characteristics: $t_r \leq 15$ ns, $R_{in} \geq 10 M\Omega$, $C_{in} \leq 5$ pF.
- c. Resistors must be noninductive types.
- d. The d-c power supplies may require additional bypassing in order to minimize ringing.

TYPES 2N4000, 2N4001

N-P-N EPITAXIAL PLANAR SILICON POWER TRANSISTORS

TYPICAL CHARACTERISTICS

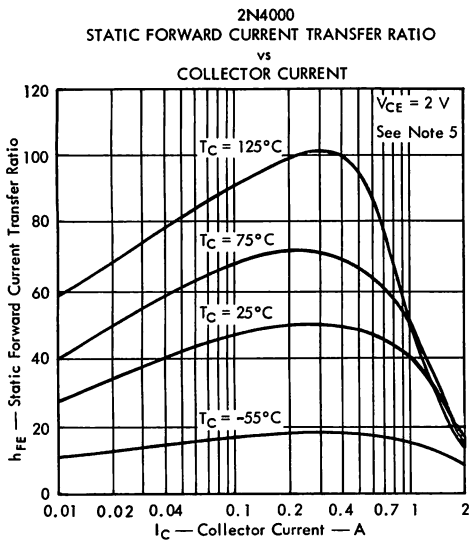

FIGURE 2

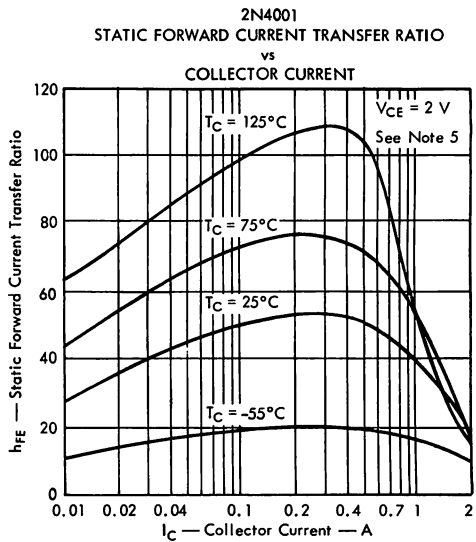

FIGURE 3

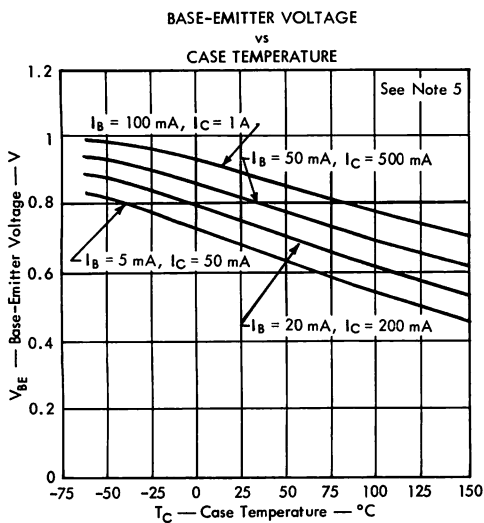

FIGURE 4

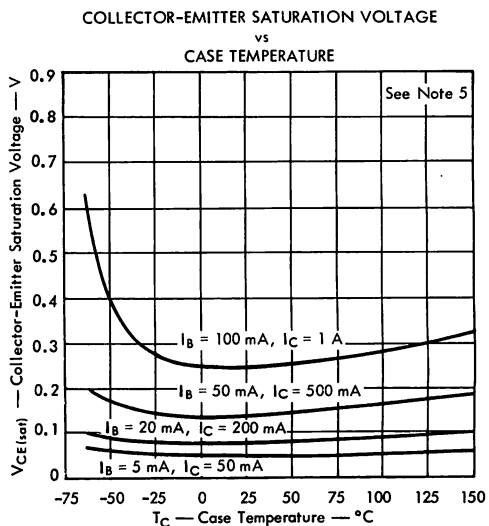
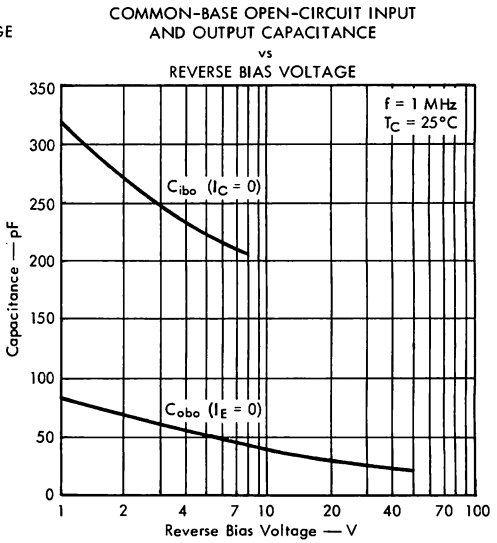
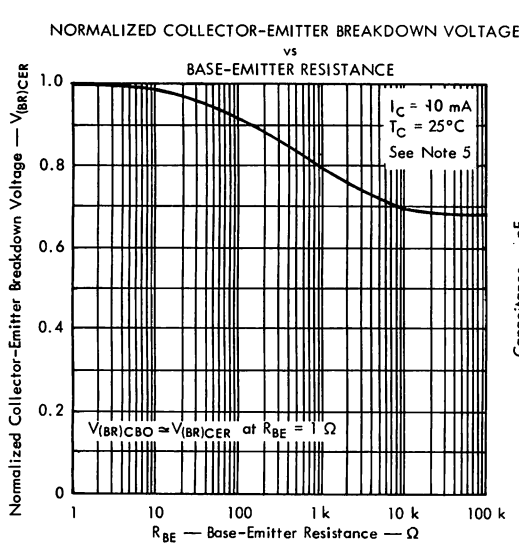

FIGURE 5

NOTE 5: These parameters must be measured using pulse techniques. $t_p = 300\ \mu\text{s}$, duty cycle $\leq 2\%$.

TYPES 2N4000, 2N4001 N-P-N EPITAXIAL PLANAR SILICON POWER TRANSISTORS

TYPICAL CHARACTERISTICS



NOTE 5: These parameters must be measured using pulse techniques. $t_p = 300 \mu s$, duty cycle $\leq 2\%$.

MAXIMUM SAFE OPERATING REGION

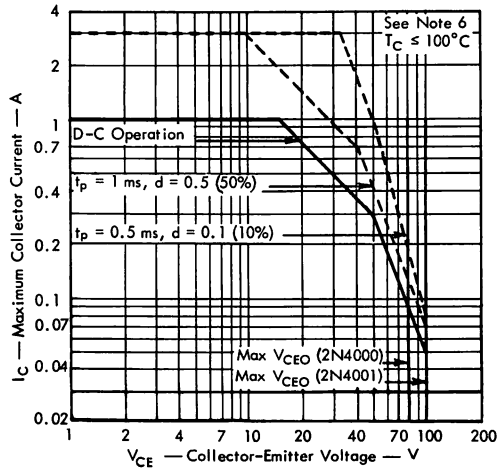

NOTE 6: Operation above maximum V_{CEO} is permissible if the base is reverse-voltage-biased with respect to the emitter and the collector-base voltage rating is not exceeded.

TYPES 2N4000, 2N4001

N-P-N EPITAXIAL PLANAR SILICON POWER TRANSISTORS

THERMAL INFORMATION

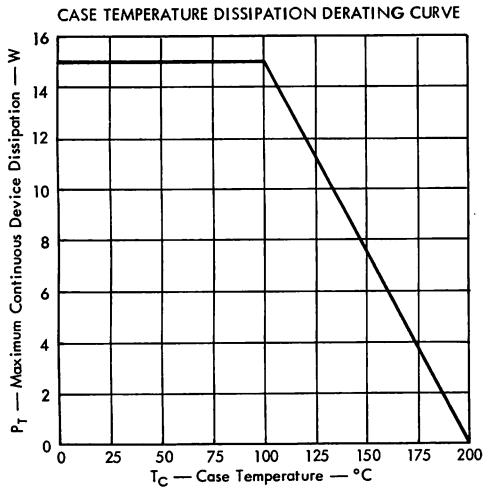

FIGURE 9

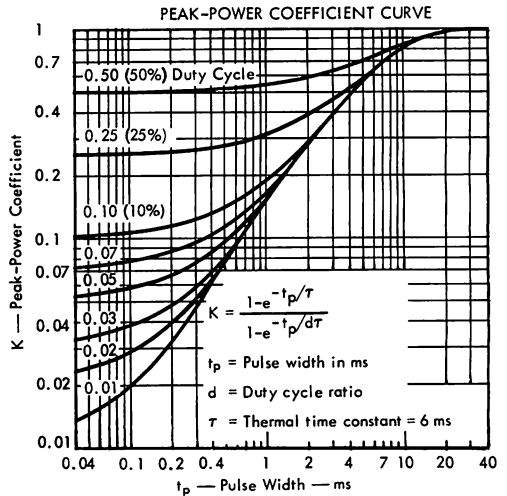

FIGURE 10

SYMBOL DEFINITION

SYMBOL	DEFINITION	VALUE	UNIT
$P_{T(avg)}$	Average Power Dissipation		W
$P_{T(max)}$	Peak Power Dissipation		W
θ_{J-A}	Junction-to-Free-Air Thermal Resistance	175	deg/W
θ_{J-C}	Junction-to-Case Thermal Resistance	6.67	deg/W
θ_{C-A}	Case-to-Free-Air Thermal Resistance	168.33	deg/W
θ_{C-HS}	Case-to-Heat-Sink Thermal Resistance		deg/W
θ_{HS-A}	Heat-Sink-to-Free-Air Thermal Resistance		deg/W
T_A	Free-Air Temperature		°C
T_C	Case Temperature		°C
$T_{J(avg)}$	Average Junction Temperature	≤ 200	°C
$T_{J(max)}$	Peak Junction Temperature	≤ 200	°C
K	Peak-Power Coefficient	See Figure 10	
t_p	Pulse Width		ms
t_x	Pulse Period		ms
d	Duty Cycle Ratio (t_p/t_x)		

Example — Find $P_{T(max)}$ (design limit)

OPERATING CONDITIONS:

$$\theta_{C-HS} + \theta_{HS-A} = 7 \text{ deg/W (From information supplied with heat sink.)}$$

$$T_{J(avg)} \text{ (design limit)} = 200^\circ\text{C}$$

$$T_A = 50^\circ\text{C}$$

$$d = 10\% (0.1)$$

$$t_p = 1 \text{ ms}$$

Equation No. 1 — Application: d-c power dissipation, heat sink used.

$$P_{T(avg)} = \frac{T_{J(avg)} - T_A}{\theta_{J-C} + \theta_{C-HS} + \theta_{HS-A}} \text{ for } 100^\circ\text{C} \leq T_C \leq 200^\circ\text{C}$$

as in Figure 9

Equation No. 2 — Application: d-c power dissipation, no heat sink used.

$$P_{T(avg)} = \frac{T_{J(avg)} - T_A}{\theta_{C-A}} \text{ for } 25^\circ\text{C} \leq T_A \leq 200^\circ\text{C}$$

Equation No. 3 — Application: Peak power dissipation, heat sink used.

$$P_{T(max)} = \frac{T_{J(max)} - T_A}{d(\theta_{C-HS} + \theta_{HS-A}) + K\theta_{J-C}} \text{ for } 100^\circ\text{C} \leq T_C \leq 200^\circ\text{C}$$

Equation No. 4 — Application: Peak power dissipation, no heat sink used.

$$P_{T(max)} = \frac{T_{J(max)} - T_A}{d\theta_{C-A} + K\theta_{J-C}} \text{ for } 25^\circ\text{C} \leq T_A \leq 200^\circ\text{C}$$

Solution:

From Figure 10, Peak-Power Coefficient

$$K = 0.19 \text{ and by use of equation No. 3}$$

$$P_{T(max)} = \frac{T_{J(max)} - T_A}{d(\theta_{C-HS} + \theta_{HS-A}) + K\theta_{J-C}}$$

$$P_{T(max)} = \frac{200 - 50}{0.1(7) + (0.19)(6.67)} = 76 \text{ W}$$

TYPES 2N4002, 2N4003 N-P-N EPITAXIAL PLANAR SILICON POWER TRANSISTORS



TYPES 2N4002, 2N4003
BULLETIN NO. DLS-668606, MAY 1966

FOR POWER-AMPLIFIER AND HIGH-SPEED-SWITCHING APPLICATIONS

- 30-A Rated Continuous Collector Current
- 100 Watts at 100°C Case Temperature
- Maximum $V_{CE(sat)}$ of 1.2 V at 30 A
- Maximum V_{BE} of 1.8 V at 30 A
- Maximum t_{on} of 1 μs at 15 A

*mechanical data

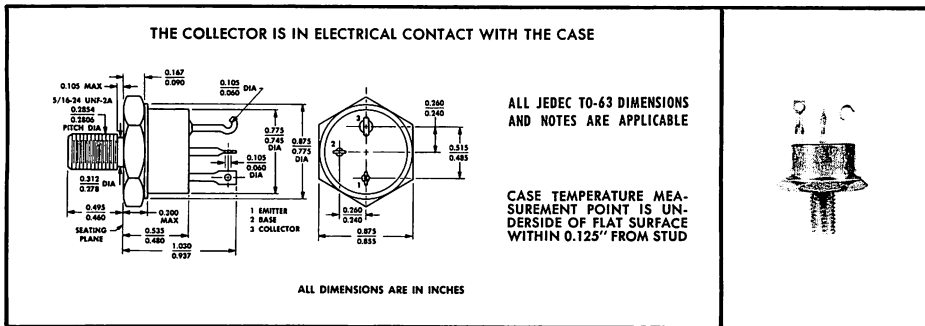

*absolute maximum ratings at 25°C case temperature (unless otherwise noted)

	2N4002	2N4003
Collector-Base Voltage	100 V	120 V
Collector-Emitter Voltage (See Note 1)	80 V	100 V
Emitter-Base Voltage	← 8 V →	
Continuous Collector Current	← 30 A →	
Peak Collector Current (See Note 2)	← 40 A →	
Continuous Base Current	← 10 A →	
Continuous Emitter Current	← 30 A →	
Safe Operating Region at (or below) 100°C Case Temperature	See Figure 7	
Continuous Device Dissipation at (or below) 100°C Case Temperature (See Note 3)	← 100 W →	
Continuous Device Dissipation at (or below) 25°C Free-Air Temperature (See Note 4)	← 4 W →	
Operating Collector Junction Temperature Range	-65°C to 200°C	
Storage Temperature Range	-65°C to 200°C	
Terminal Temperature 1/8 Inch from Case for 10 Seconds	← 230°C →	

- NOTES: 1. These values apply when the base-emitter diode is open-circuited.
 2. This value applies for $t_p \leq 0.3$ ms, duty cycle $\leq 10\%$.
 3. Derate linearly to 200°C case temperature at the rate of 1 W/deg.
 4. Derate linearly to 200°C free-air temperature at the rate of 22.9 mW/deg.

*Indicates JEDEC registered data.

TYPES 2N4002, 2N4003

N-P-N EPITAXIAL PLANAR SILICON POWER TRANSISTORS

*electrical characteristics at 25°C case temperature (unless otherwise noted)

PARAMETER	TEST CONDITIONS	2N4002		2N4003		UNIT
		MIN	MAX	MIN	MAX	
$V_{(BR)CEO}$ Collector-Emitter Breakdown Voltage	$I_C = 30 \text{ mA}$, $I_B = 0$, See Note 5	80		100		V
I_{CEO} Collector Cutoff Current	$V_{CE} = 40 \text{ V}$, $I_B = 0$	2				mA
	$V_{CE} = 50 \text{ V}$, $I_B = 0$			2		
I_{CES} Collector Cutoff Current	$V_{CE} = 90 \text{ V}$, $V_{BE} = 0$	1				mA
	$V_{CE} = 110 \text{ V}$, $V_{BE} = 0$			1		
	$V_{CE} = 90 \text{ V}$, $V_{BE} = 0$, $T_C = 150^\circ\text{C}$	2				
	$V_{CE} = 110 \text{ V}$, $V_{BE} = 0$, $T_C = 150^\circ\text{C}$			2		
I_{EBO} Emitter Cutoff Current	$V_{EB} = 5 \text{ V}$, $I_C = 0$	100		100		μA
	$V_{EB} = 8 \text{ V}$, $I_C = 0$	50		50		mA
h_{FE} Static Forward Current Transfer Ratio	$V_{CE} = 4 \text{ V}$, $I_C = 30 \text{ A}$, See Notes 5 and 6	10		10		
	$V_{CE} = 4 \text{ V}$, $I_C = 15 \text{ A}$, See Notes 5 and 6	20	80	20	80	
V_{BE} Base-Emitter Voltage	$V_{CE} = 4 \text{ V}$, $I_C = 30 \text{ A}$, See Notes 5 and 6	1.8		1.8		V
$V_{CE(sat)}$ Collector-Emitter Saturation Voltage	$I_B = 4 \text{ A}$, $I_C = 30 \text{ A}$, See Notes 5 and 6	1.2		1.2		V
h_{fo} Small-Signal Common-Emitter Forward Current Transfer Ratio	$V_{CE} = 4 \text{ V}$, $I_C = 1 \text{ A}$, $f = 1 \text{ kHz}$	30		30		
$ h_{fe} $ Small-Signal Common-Emitter Forward Current Transfer Ratio	$V_{CE} = 10 \text{ V}$, $I_C = 1 \text{ A}$, $f = 10 \text{ MHz}$	3		3		

NOTES: 5. These parameters must be measured using pulse techniques. $t_p = 300 \mu\text{s}$, duty cycle $\leq 2\%$.

6. These parameters are measured with voltage-sensing contacts separate from the current-carrying contacts.

*thermal characteristics

PARAMETER		MAX	UNIT
θ_{J-C} Junction-to-Case Thermal Resistance		1	deg/W
θ_{J-A} Junction-to-Free-Air Thermal Resistance		43.7	deg/W

*Indicates JEDEC registered data.

TYPES 2N4002, 2N4003 N-P-N EPITAXIAL PLANAR SILICON POWER TRANSISTORS

*switching characteristics at 25°C case temperature

PARAMETER	TEST CONDITIONS†	MAX	UNIT
t_{on} Turn-On Time	$I_C = 15 \text{ A}$, $I_{B(1)} = 1.5 \text{ A}$, $I_{B(2)} = -1.5 \text{ A}$,	1	μs
t_{off} Turn-Off Time	$V_{BE(off)} = -2 \text{ V}$, $R_L = 3 \Omega$, See Figure 1	3	

†Voltage and current values shown are nominal; exact values vary slightly with transistor parameters.

*PARAMETER MEASUREMENT INFORMATION

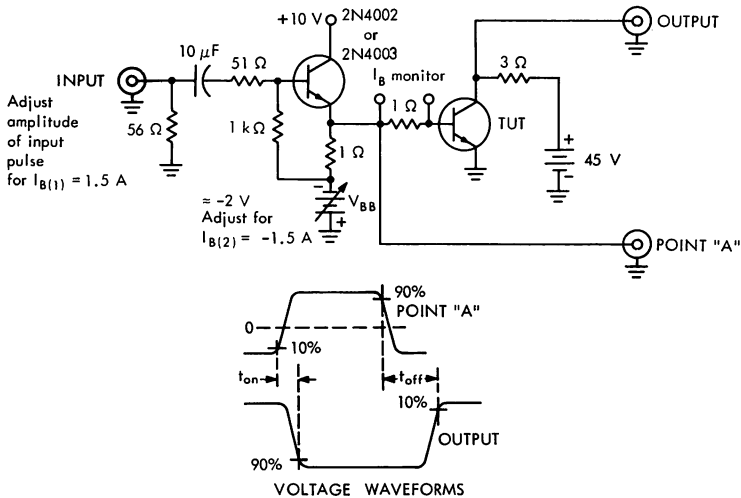
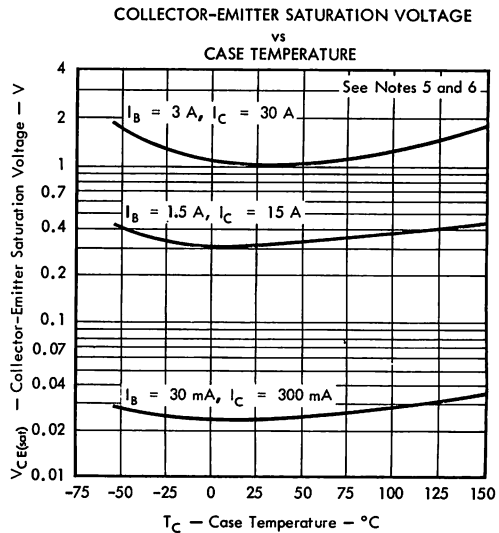
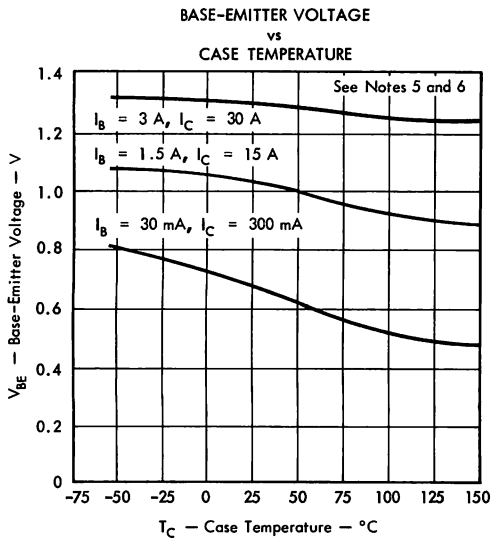
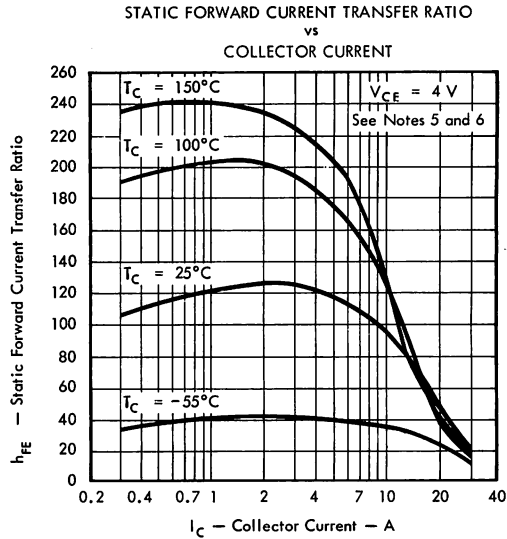

FIGURE 1

- NOTES: a. The input waveform at point "A" has the following characteristics: $t_r \leq 100 \text{ ns}$, $t_f \leq 100 \text{ ns}$, $t_p = 20 \mu\text{s}$, duty cycle $\leq 0.2\%$.
 b. Waveforms are monitored on an oscilloscope with the following characteristics: $t_r \leq 5 \text{ ns}$, $R_{in} \geq 1 \text{ M}\Omega$, $C_{in} \leq 5 \text{ pF}$.
 c. Resistors must be noninductive types.
 d. The d-c power supplies may require additional bypassing in order to minimize ringing.

*Indicates JEDEC registered data.

TYPES 2N4002, 2N4003 N-P-N EPITAXIAL PLANAR SILICON POWER TRANSISTORS



NOTES: 5. These parameters must be measured using pulse techniques. $t_p = 300 \mu s$, duty cycle $\leq 2\%$.

6. These parameters are measured with voltage-sensing contacts separate from the current-carrying contacts.

TYPES 2N4002, 2N4003 N-P-N EPITAXIAL PLANAR SILICON POWER TRANSISTORS

TYPICAL CHARACTERISTICS

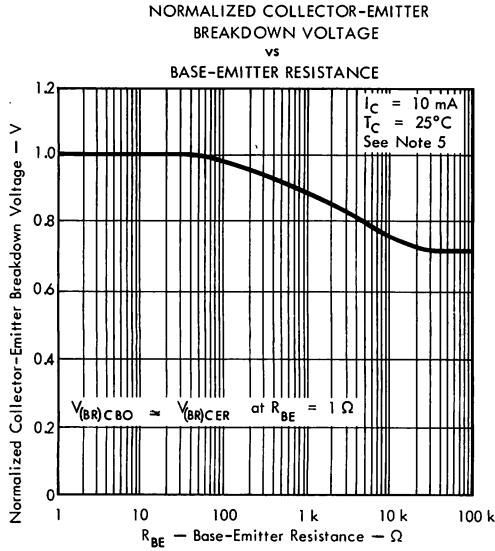

FIGURE 5

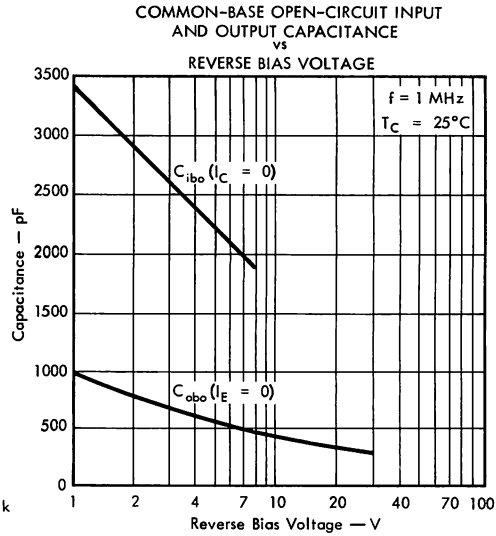

FIGURE 6

NOTE 5: These parameters must be measured using pulse techniques. $t_p = 300 \mu\text{s}$, duty cycle $\leq 2\%$.

MAXIMUM SAFE OPERATING REGION

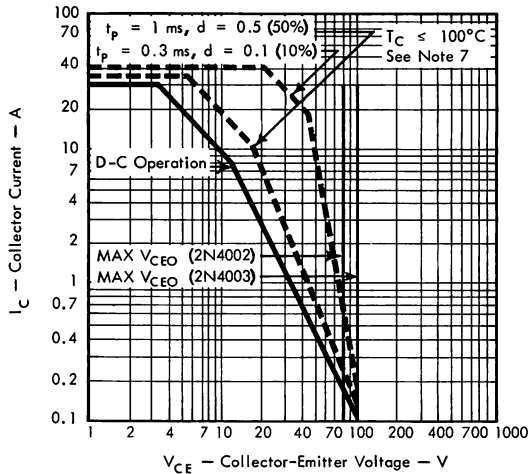

FIGURE 7

Operation above maximum V_{CEO} is permissible if the base is reverse-voltage biased with respect to the emitter and the collector-base voltage rating is not exceeded.

TYPES 2N4002, 2N4003 N-P-N EPITAXIAL PLANAR SILICON POWER TRANSISTORS

THERMAL INFORMATION

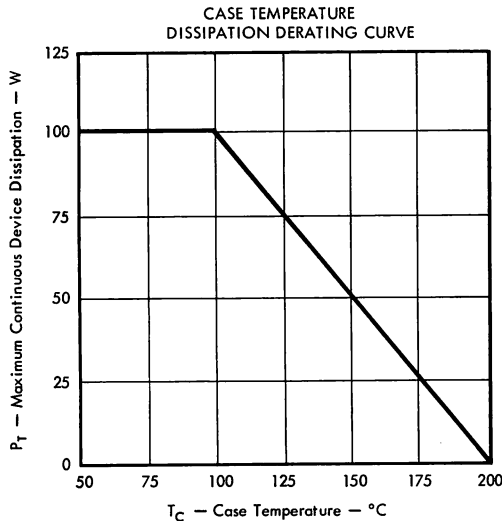

FIGURE 8

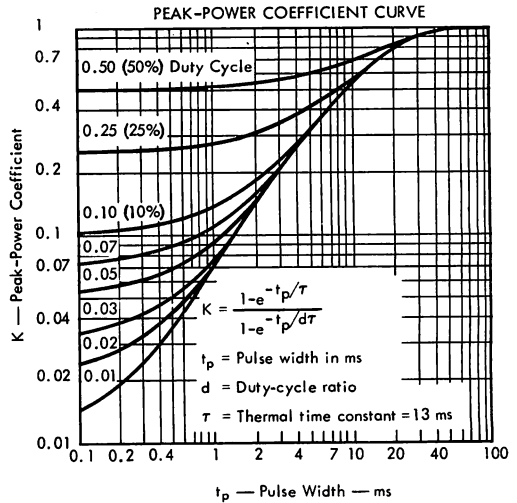

FIGURE 9

SYMBOL DEFINITION

SYMBOL	DEFINITION	VALUE	UNIT
P _{T(avg)}	Average Power Dissipation		W
P _{T(max)}	Peak Power Dissipation		W
θ _{J-A}	Junction-to-Free-Air Thermal Resistance	43.7	deg/W
θ _{J-C}	Junction-to-Case Thermal Resistance	1	deg/W
θ _{C-A}	Case-to-Free-Air Thermal Resistance	42.7	deg/W
θ _{C-HS}	Case-to-Heat-Sink Thermal Resistance		deg/W
θ _{HS-A}	Heat-Sink-to-Free-Air Thermal Resistance		deg/W
T _A	Free-Air Temperature		°C
T _C	Case Temperature		°C
T _{J(avg)}	Average Junction Temperature	≤ 200	°C
T _{J(max)}	Peak Junction Temperature	≤ 200	°C
K	Peak-Power Coefficient	See Figure 9	
t _p	Pulse Width		ms
t _x	Pulse Period		ms
d	Duty-Cycle Ratio (t _p /t _x)		

Equation No. 1 — Application: d-c power dissipation, heat sink used.

$$P_{T(avg)} = \frac{T_{J(avg)} - T_A}{\theta_{J-C} + \theta_{C-HS} + \theta_{HS-A}} \text{ as in Figure 8, for } 100^\circ\text{C} \leq T_C \leq 200^\circ\text{C}$$

Equation No. 2 — Application: d-c power dissipation, no heat sink used.

$$P_{T(avg)} = \frac{T_{J(avg)} - T_A}{\theta_{J-A}} \text{ for } 25^\circ\text{C} \leq T_A \leq 200^\circ\text{C}$$

Equation No. 3 — Application: Peak power dissipation, heat sink used.

$$P_{T(max)} = \frac{T_{J(max)} - T_A}{d(\theta_{C-HS} + \theta_{HS-A}) + K\theta_{J-C}} \text{ for } 100^\circ\text{C} \leq T_C \leq 200^\circ\text{C}$$

Equation No. 4 — Application: Peak power dissipation, no heat sink used.

$$P_{T(max)} = \frac{T_{J(max)} - T_A}{d\theta_{C-A} + K\theta_{J-C}} \text{ for } 25^\circ\text{C} \leq T_A \leq 200^\circ\text{C}$$

Example — Find P_{T(max)} (design limit)

OPERATING CONDITIONS:

$$\theta_{C-HS} + \theta_{HS-A} = 2.5 \text{ deg/W (From information supplied with heat sink.)}$$

$$T_{J(avg)} \text{ (design limit)} = 200^\circ\text{C}$$

$$T_A = 50^\circ\text{C}$$

$$d = 10\% (0.1)$$

$$t_p = 0.1 \text{ ms}$$

Solution:

From Figure 9, Peak-Power Coefficient

$$K = 0.1 \text{ and by use of equation No. 3}$$

$$P_{T(max)} = \frac{T_{J(max)} - T_A}{d(\theta_{C-HS} + \theta_{HS-A}) + K\theta_{J-C}}$$

$$P_{T(max)} = \frac{200 - 50}{0.1(2.5) + 0.1(1)} = 428 \text{ W}$$

TYPE 2N4300 N-P-N EPITAXIAL PLANAR SILICON POWER TRANSISTOR



TYPE 2N4300
BULLETIN NO. DL-5-648582, MAY 1966

FOR POWER-AMPLIFIER AND HIGH-SPEED-SWITCHING APPLICATIONS

- 15 W at 100°C Case Temperature
- Max $V_{CE(sat)}$ of 0.3 V at 1 A I_C
- Typ t_{on} of 130 ns at 1 A I_C
- Min f_T of 30 MHz

*mechanical data

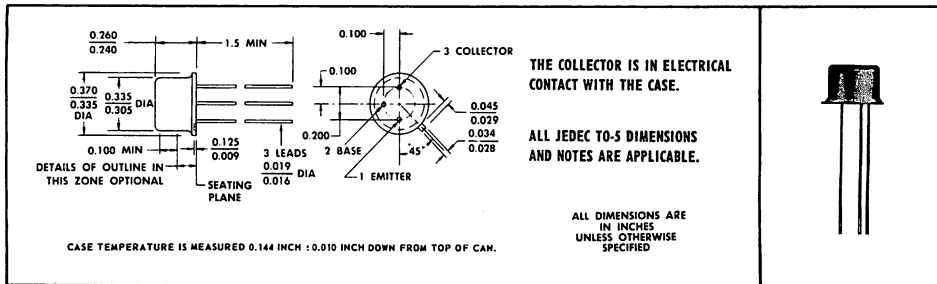

*absolute maximum ratings at 25°C case temperature (unless otherwise noted)

Collector-Base Voltage	100 V
Collector-Emitter Voltage (See Note 1)	80 V
Emitter-Base Voltage	8 V
Continuous Collector Current	2 A
Peak Collector Current (See Note 2)	4 A
Continuous Base Current	1 A
Continuous Emitter Current	3 A
Safe Operating Region at (or below) 100°C Case Temperature	See Figure 7
Continuous Device Dissipation at (or below) 100°C Case Temperature (See Note 3).	15 W
Continuous Device Dissipation at (or below) 25°C Free-Air Temperature (See Note 4)	1 W
Operating Collector Junction Temperature Range	-65°C to 200°C
Storage Temperature Range	-65°C to 200°C
Lead Temperature $\frac{1}{16}$ Inch from Case for 10 Seconds	230°C

NOTES: 1. This value applies when the base-emitter diode is open-circuited.

2. This value applies for $t_p \leq 0.3$ ms, duty cycle $\leq 10\%$.

3. Derate linearly to 200°C case temperature at the rate of 0.15 W/deg.

4. Derate linearly to 200°C free-air temperature at the rate of 5.72 mW/deg.

*Indicates JEDEC registered data.



TEXAS INSTRUMENTS
INCORPORATED
POST OFFICE BOX 5012 • DALLAS, TEXAS 75222

16625

TYPE 2N4300

N-P-N EPITAXIAL PLANAR SILICON POWER TRANSISTOR

*electrical characteristics at 25°C case temperature (unless otherwise noted)

PARAMETER		TEST CONDITIONS	MIN	MAX	UNIT
$V_{(BR)CEO}$	Collector-Emitter Breakdown Voltage	$I_C = 30 \text{ mA}$, $I_B = 0$, See Note 5	80		V
I_{CEO}	Collector Cutoff Current	$V_{CE} = 40 \text{ V}$, $I_B = 0$		1	μA
I_{CES}	Collector Cutoff Current	$V_{CE} = 90 \text{ V}$, $V_{BE} = 0$		10	μA
		$V_{CE} = 90 \text{ V}$, $V_{BE} = 0$, $T_C = 150^\circ\text{C}$		75	
I_{EBO}	Emitter Cutoff Current	$V_{EB} = 5 \text{ V}$, $I_C = 0$		0.5	μA
		$V_{EB} = 8 \text{ V}$, $I_C = 0$		10	
h_{FE}	Static Forward Current Transfer Ratio	$V_{CE} = 2 \text{ V}$, $I_C = 1 \text{ A}$, See Notes 5 and 6	30	120	
		$V_{CE} = 2 \text{ V}$, $I_C = 2 \text{ A}$, See Notes 5 and 6	15		
V_{BE}	Base-Emitter Voltage	$V_{CE} = 2 \text{ V}$, $I_C = 2 \text{ A}$, See Notes 5 and 6		1.2	V
$V_{CE(sat)}$	Collector-Emitter Saturation Voltage	$I_B = 100 \text{ mA}$, $I_C = 1 \text{ A}$, See Notes 5 and 6		0.3	V
		$I_B = 200 \text{ mA}$, $I_C = 2 \text{ A}$, See Notes 5 and 6		0.5	
h_{fo}	Small-Signal Common-Emitter Forward Current Transfer Ratio	$V_{CE} = 5 \text{ V}$, $I_C = 1 \text{ A}$, $f = 1 \text{ kHz}$	30		
$ h_{fo} $	Small-Signal Common-Emitter Forward Current Transfer Ratio	$V_{CE} = 10 \text{ V}$, $I_C = 1 \text{ A}$, $f = 15 \text{ MHz}$	2		

NOTES: 5. These parameters must be measured using pulse techniques. $t_p = 300 \mu\text{s}$, duty cycle $\leq 2\%$.

6. These parameters are measured with voltage-sensing contacts separate from the current-carrying contacts.

*thermal characteristics

PARAMETER		MAX	UNIT
θ_{J-C}	Junction-to-Case Thermal Resistance	6.66	deg/W
θ_{J-A}	Junction-to-Free-Air Thermal Resistance	175	

*Indicates JEDEC registered data.

TYPE 2N4300

N-P-N EPITAXIAL PLANAR SILICON POWER TRANSISTOR

switching characteristics at 25°C case temperature

PARAMETER	TEST CONDITIONS†			TYP	UNIT
t_{on} Turn-On Time	$I_C = 1 \text{ A}$, $V_{BE(off)} = -3.7 \text{ V}$,	$I_{B(1)} = 100 \text{ mA}$, $R_L = 20 \Omega$,	$I_{B(2)} = -100 \text{ mA}$, See Figure 1	0.13	μs
t_{off} Turn-Off Time				1.5	

†Voltage and current values shown are nominal; exact values vary slightly with transistor parameters.

PARAMETER MEASUREMENT INFORMATION

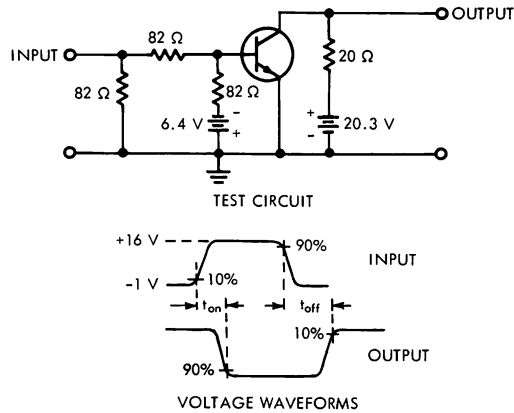

FIGURE 1

- NOTES: a. The input waveform is supplied by a generator with the following characteristics: $t_r \leq 15 \text{ ns}$, $t_f \leq 15 \text{ ns}$, $Z_{out} = 50 \Omega$, $t_p = 2 \mu\text{s}$, duty cycle $\leq 2\%$.
- b. Waveforms are monitored on an oscilloscope with the following characteristics: $t_r \leq 15 \text{ ns}$, $R_{in} \geq 10 \text{ M}\Omega$, $C_{in} \leq 11.5 \text{ pF}$.
- c. Resistors must be noninductive types.
- d. The d-c power supplies may require additional bypassing in order to minimize ringing.

TYPE 2N4300

N-P-N EPITAXIAL PLANAR SILICON POWER TRANSISTOR

TYPICAL CHARACTERISTICS

STATIC FORWARD CURRENT TRANSFER RATIO
vs
COLLECTOR CURRENT

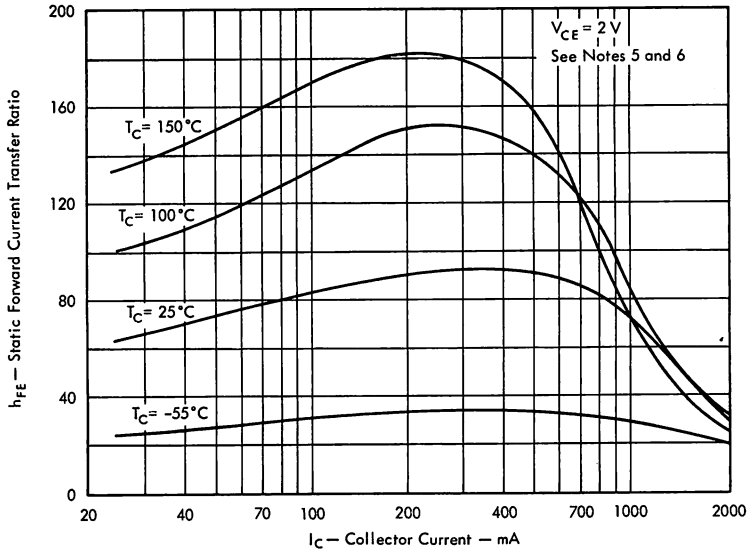

FIGURE 2

BASE-EMITTER VOLTAGE
vs
CASE TEMPERATURE

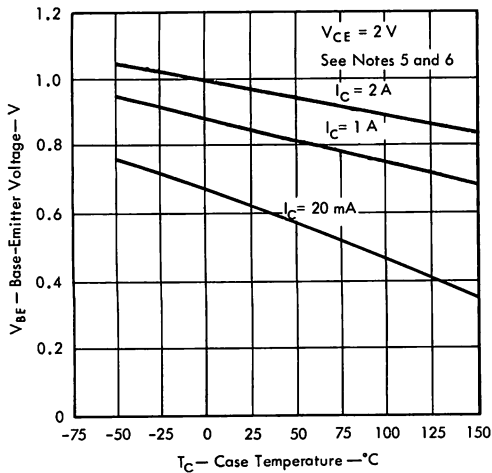

FIGURE 3

COLLECTOR-EMITTER SATURATION VOLTAGE
vs
CASE TEMPERATURE

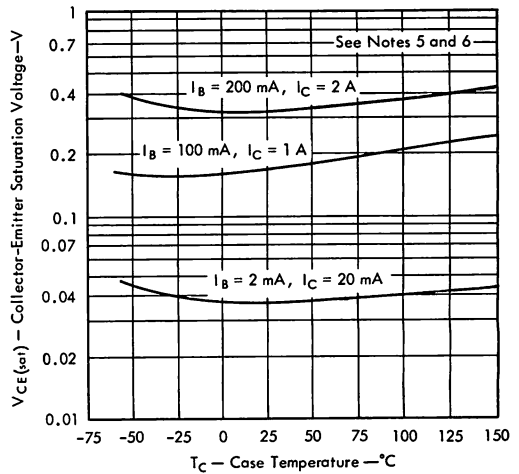

FIGURE 4

NOTES: 5. These parameters must be measured using pulse techniques. $t_p = 300\ \mu\text{s}$, duty cycle $\leq 2\%$.

6. These parameters are measured with voltage-sensing contacts separate from the current-carrying contacts.

TYPE 2N4300 N-P-N EPITAXIAL PLANAR SILICON POWER TRANSISTOR

TYPICAL CHARACTERISTICS

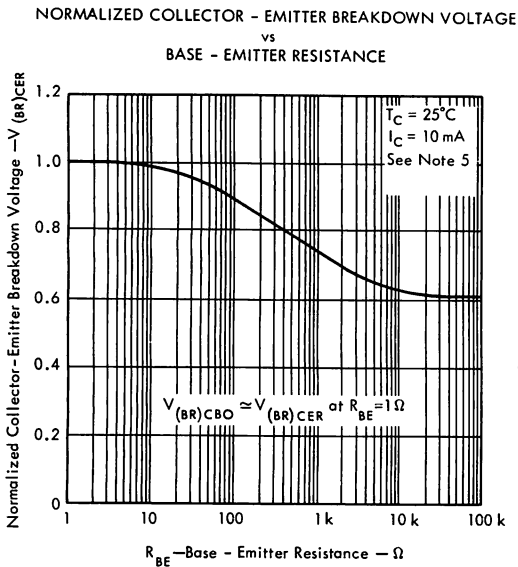

FIGURE 5

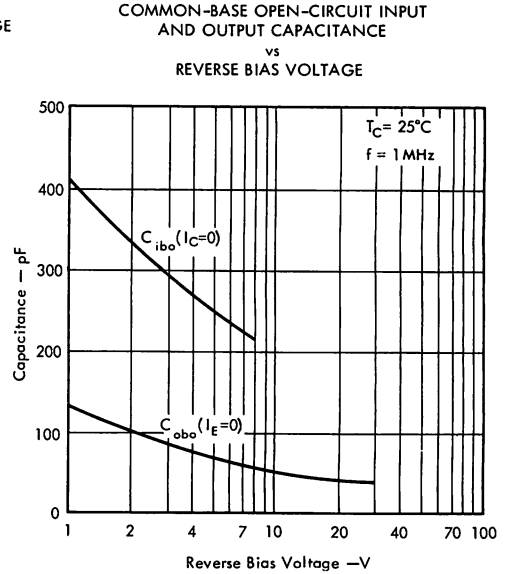

FIGURE 6

NOTE 5: These parameters must be measured using pulse techniques. $t_p = 300 \mu s$, duty cycle $\leq 2\%$.

MAXIMUM SAFE OPERATING REGION

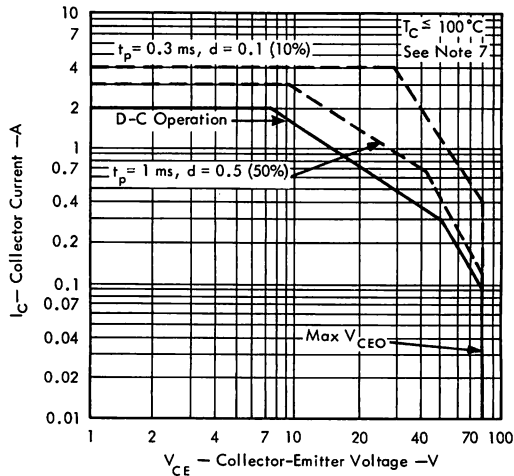

FIGURE 7

NOTE 7: Operation above maximum V_{CEO} is permissible if the base is reverse-voltage biased with respect to the emitter and the collector-base-voltage rating is not exceeded.

TYPE 2N4300

N-P-N EPITAXIAL PLANAR SILICON POWER TRANSISTOR

THERMAL INFORMATION

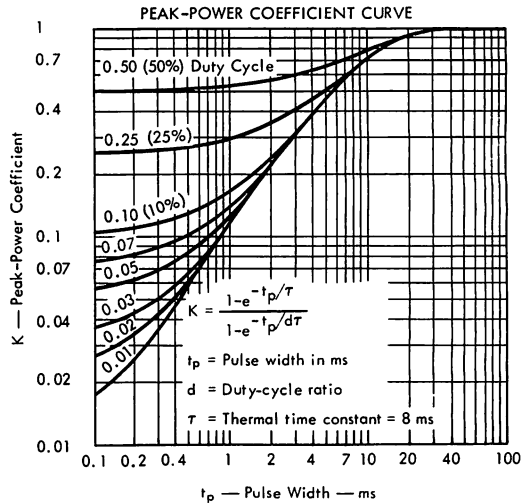
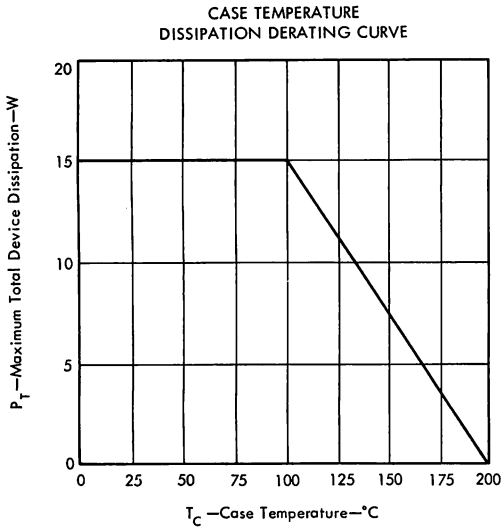

SYMBOL DEFINITION

SYMBOL	DEFINITION	VALUE	UNIT
$P_{T(avg)}$	Average Power Dissipation		W
$P_{T(max)}$	Peak Power Dissipation		W
θ_{J-A}	Junction-to-Free-Air Thermal Resistance	175	deg/W
θ_{J-C}	Junction-to-Case Thermal Resistance	6.66	deg/W
θ_{C-A}	Case-to-Free-Air Thermal Resistance	168	deg/W
θ_{C-HS}	Case-to-Heat-Sink Thermal Resistance		deg/W
θ_{HS-A}	Heat-Sink-to-Free-Air Thermal Resistance		deg/W
T_A	Free-Air Temperature		°C
T_C	Case Temperature		°C
$T_{J(avg)}$	Average Junction Temperature	≤ 200	°C
$T_{J(max)}$	Peak Junction Temperature	≤ 200	°C
K	Peak-Power Coefficient	See Figure 9	
t_p	Pulse Width		ms
t_x	Pulse Period		ms
d	Duty-Cycle Ratio (t_p/t_x)		

Equation No. 1 — Application: d-c power dissipation, heat sink used.

$$P_{T(avg)} = \frac{T_{J(avg)} - T_A}{\theta_{J-C} + \theta_{C-HS} + \theta_{HS-A}} \quad \text{for } 100^\circ\text{C} \leq T_C \leq 200^\circ\text{C} \quad \text{as in Figure 8}$$

Equation No. 2 — Application: d-c power dissipation, no heat sink used.

$$P_{T(avg)} = \frac{T_{J(avg)} - T_A}{\theta_{J-A}} \quad \text{for } 25^\circ\text{C} \leq T_A \leq 200^\circ\text{C}$$

Equation No. 3 — Application: Peak power dissipation, heat sink used.

$$P_{T(max)} = \frac{T_{J(max)} - T_A}{d(\theta_{C-HS} + \theta_{HS-A}) + K\theta_{J-C}} \quad \text{for } 100^\circ\text{C} \leq T_C \leq 200^\circ\text{C}$$

Equation No. 4 — Application: Peak power dissipation, no heat sink used.

$$P_{T(max)} = \frac{T_{J(max)} - T_A}{d\theta_{C-A} + K\theta_{J-C}} \quad \text{for } 25^\circ\text{C} \leq T_A \leq 200^\circ\text{C}$$

Example — Find $P_{T(max)}$ (design limit)

OPERATING CONDITIONS:

$$\theta_{C-HS} + \theta_{HS-A} = 7 \text{ deg/W (From information supplied with heat sink.)}$$

$$T_{J(avg)} \text{ (design limit)} = 200^\circ\text{C}$$

$$T_A = 50^\circ\text{C}$$

$$d = 10\% (0.1)$$

$$t_p = 0.1 \text{ ms}$$

Solution:

From Figure 9, Peak-Power Coefficient

$$K = 0.105 \text{ and by use of equation No. 3}$$

$$P_{T(max)} = \frac{T_{J(max)} - T_A}{d(\theta_{C-HS} + \theta_{HS-A}) + K\theta_{J-C}}$$

$$P_{T(max)} = \frac{200 - 50}{0.1(7) + 0.105(6.66)} = 107 \text{ W}$$

TYPE 2N4301 N-P-N EPITAXIAL PLANAR SILICON POWER TRANSISTOR



FOR POWER-AMPLIFIER AND HIGH-SPEED-SWITCHING APPLICATIONS

- 50 W at 100°C Case Temperature
- Max $V_{CE(sat)}$ of 0.4 V at 5 A I_C
- Typ t_{on} of 150 ns at 5 A I_C
- Min f_T of 40 MHz

TYPE 2N4301
BULLETIN NO. DL-5 668510, MAY 1966

***mechanical data**

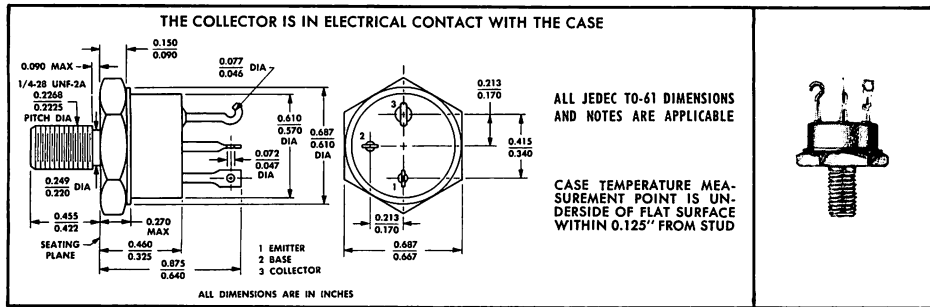

***absolute maximum ratings at 25°C case temperature (unless otherwise noted)**

Collector-Base Voltage	100 V
Collector-Emitter Voltage (See Note 1)	80 V
Emitter-Base Voltage	8 V
Continuous Collector Current	10 A
Peak Collector Current (See Note 2)	20 A
Continuous Base Current	4 A
Continuous Emitter Current	10 A
Safe Operating Region at (or below) 100°C Case Temperature	See Figure 7
Continuous Device Dissipation at (or below) 100°C Case Temperature (See Note 3)	50 W
Continuous Device Dissipation at (or below) 25°C Free-Air Temperature (See Note 4)	3.5 W
Operating Collector Junction Temperature Range	-65°C to 200°C
Storage Temperature Range	-65°C to 200°C
Terminal Temperature 1/8 Inch from Case for 10 Seconds	230°C

- NOTES: 1. This value applies when the base-emitter diode is open-circuited.
 2. This value applies for $t_p \leq 0.3$ ms, duty cycle $\leq 10\%$.
 3. Derate linearly to 200°C case temperature at the rate of 0.5 W/deg.
 4. Derate linearly to 200°C free-air temperature at the rate of 20 mW/deg.

*Indicates JEDEC registered data.

TYPE 2N4301

N-P-N EPITAXIAL PLANAR SILICON POWER TRANSISTOR

*electrical characteristics at 25°C case temperature (unless otherwise noted)

PARAMETER	TEST CONDITIONS	MIN	MAX	UNIT
$V_{(BR)CEO}$ Collector-Emitter Breakdown Voltage	$I_C = 30 \text{ mA}$, $I_B = 0$, See Note 5	80		V
I_{CEO} Collector Cutoff Current	$V_{CE} = 40 \text{ V}$, $I_B = 0$		10	μA
I_{CES} Collector Cutoff Current	$V_{CE} = 90 \text{ V}$, $V_{BE} = 0$		10	μA
	$V_{CE} = 90 \text{ V}$, $V_{BE} = 0$, $T_C = 150^\circ\text{C}$		500	
I_{EBO} Emitter Cutoff Current	$V_{EB} = 5 \text{ V}$, $I_C = 0$		5	μA
	$V_{EB} = 8 \text{ V}$, $I_C = 0$		50	
h_{FE} Static Forward Current Transfer Ratio	$V_{CE} = 4 \text{ V}$, $I_C = 5 \text{ A}$, See Notes 5 and 6	30	120	
	$V_{CE} = 4 \text{ V}$, $I_C = 10 \text{ A}$, See Notes 5 and 6	15		
V_{BE} Base-Emitter Voltage	$V_{CE} = 4 \text{ V}$, $I_C = 10 \text{ A}$, See Notes 5 and 6		1.2	V
$V_{CE(sat)}$ Collector-Emitter Saturation Voltage	$I_B = 0.5 \text{ A}$, $I_C = 5 \text{ A}$, See Notes 5 and 6		0.4	V
	$I_B = 1.3 \text{ A}$, $I_C = 10 \text{ A}$, See Notes 5 and 6		1	
h_{fo} Small-Signal Common-Emitter Forward Current Transfer Ratio	$V_{CE} = 5 \text{ V}$, $I_C = 1 \text{ A}$, $f = 1 \text{ kHz}$	30		
$ h_{fe} $ Small-Signal Common-Emitter Forward Current Transfer Ratio	$V_{CE} = 5 \text{ V}$, $I_C = 1 \text{ A}$, $f = 20 \text{ MHz}$	2		

NOTES: 5. These parameters must be measured using pulse techniques. $t_p = 300 \mu\text{s}$, duty cycle $\leq 2\%$.

6. These parameters are measured with voltage-sensing contacts separate from the current-carrying contacts.

*thermal characteristics

PARAMETER	MAX	UNIT
θ_{J-C} Junction-to-Case Thermal Resistance	2	deg/W
θ_{J-A} Junction-to-Free-Air Thermal Resistance	50	

*Indicates JEDEC registered data.

TYPE 2N4301

N-P-N EPITAXIAL PLANAR SILICON POWER TRANSISTOR

switching characteristics at 25°C case temperature

PARAMETER	TEST CONDITIONS†	TYP	UNIT
t_{on} Turn-On Time	$I_C = 5 \text{ A}$, $I_{B(1)} = 500 \text{ mA}$, $I_{B(2)} = -500 \text{ mA}$, $V_{BE(off)} = -5 \text{ V}$, $R_L = 5 \Omega$, See Figure 1	0.15	μs
t_{off} Turn-Off Time		1.5	

†Voltage and current values shown are nominal; exact values vary slightly with transistor parameters.

PARAMETER MEASUREMENT INFORMATION

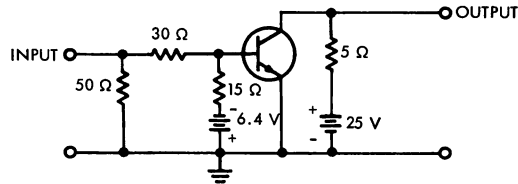

TEST CIRCUIT

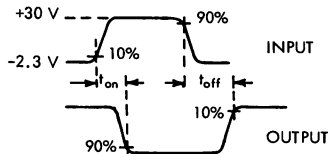

VOLTAGE WAVEFORMS

FIGURE 1

- NOTES:
- The input waveform is supplied by a generator with the following characteristics: $t_r \leq 15 \text{ ns}$, $t_f \leq 15 \text{ ns}$, $Z_{out} = 50 \Omega$, $t_p = 10 \mu\text{s}$, duty cycle $\leq 2\%$.
 - Waveforms are monitored on an oscilloscope with the following characteristics: $t_r \leq 15 \text{ ns}$, $R_{in} \geq 10 \text{ M}\Omega$, $C_{in} \leq 11.5 \text{ pF}$.
 - Resistors must be noninductive types.
 - The d-c power supplies may require additional bypassing in order to minimize ringing.

TYPE 2N4301

N-P-N EPITAXIAL PLANAR SILICON POWER TRANSISTOR

TYPICAL CHARACTERISTICS

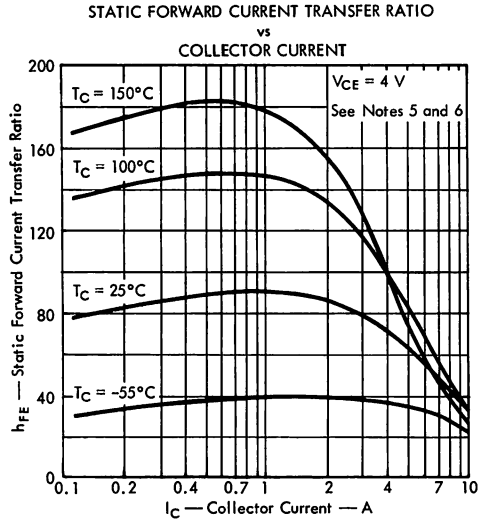

FIGURE 2

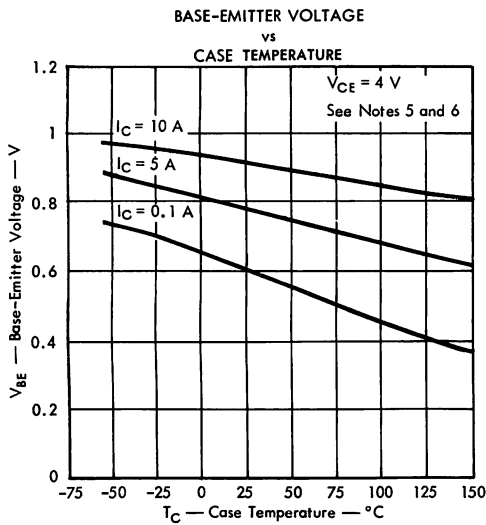

FIGURE 3

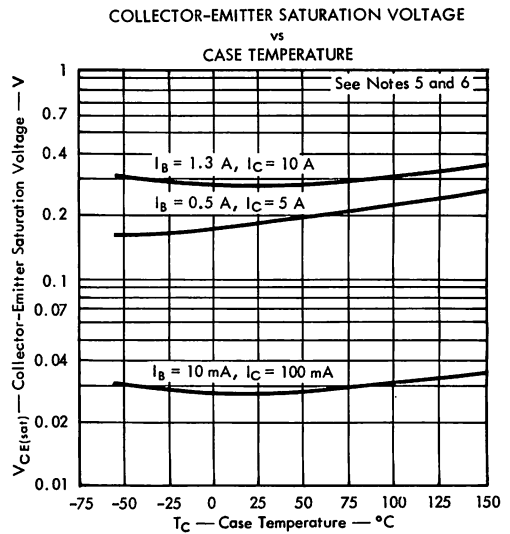

FIGURE 4

NOTES: 5. These parameters must be measured using pulse techniques. $t_p = 300 \mu\text{s}$, duty cycle $\leq 2\%$.

6. These parameters are measured with voltage-sensing contacts separate from the current-carrying contacts.

TYPE 2N4301

N-P-N EPITAXIAL PLANAR SILICON POWER TRANSISTOR

TYPICAL CHARACTERISTICS

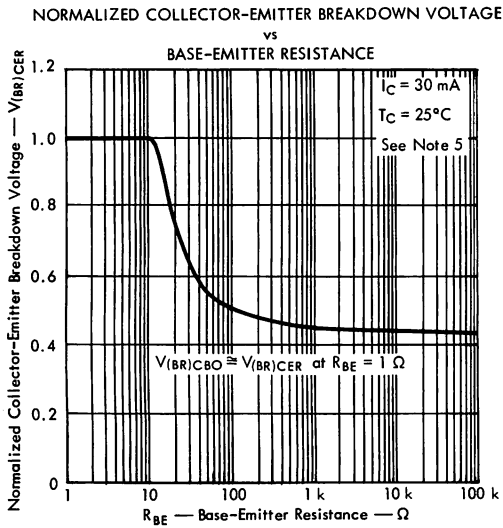

FIGURE 5

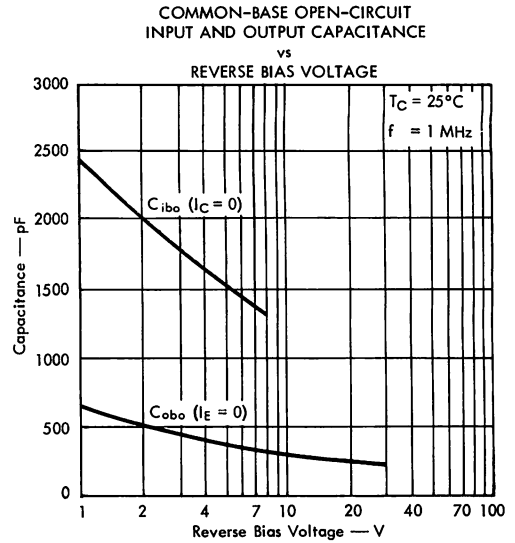

FIGURE 6

MAXIMUM SAFE OPERATING REGION

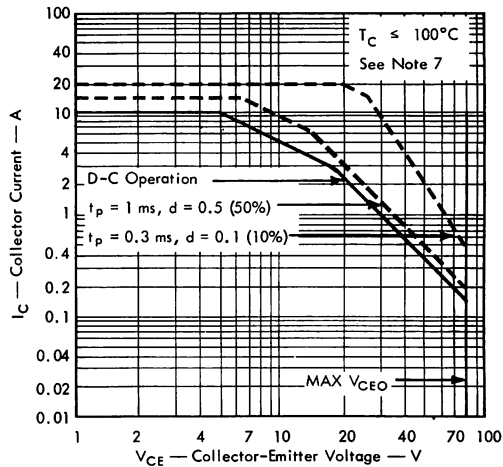

FIGURE 7

NOTE 7: Operation above maximum V_{CE0} is permissible if the base is reverse-voltage biased with respect to the emitter and the collector-base-voltage rating is not exceeded.

TYPE 2N4301

N-P-N EPITAXIAL PLANAR SILICON POWER TRANSISTOR

THERMAL INFORMATION

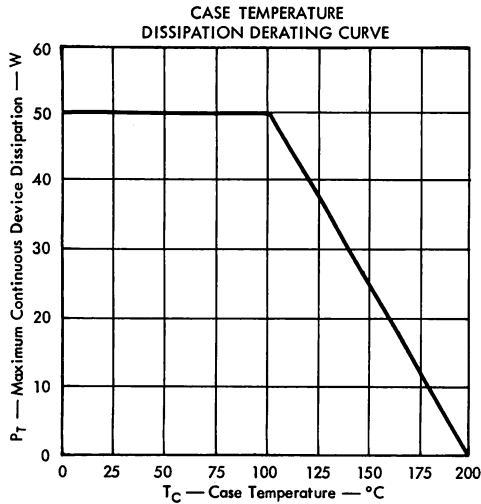

FIGURE 8

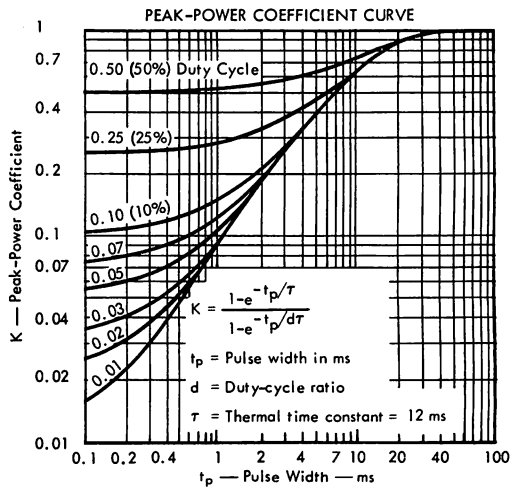

FIGURE 9

SYMBOL DEFINITION

SYMBOL	DEFINITION	VALUE	UNIT
P _{T(avg)}	Average Power Dissipation		W
P _{T(max)}	Peak Power Dissipation		W
θ _{J-A}	Junction-to-Free-Air Thermal Resistance	50	deg/W
θ _{J-C}	Junction-to-Case Thermal Resistance	2	deg/W
θ _{C-A}	Case-to-Free-Air Thermal Resistance	48	deg/W
θ _{C-HS}	Case-to-Heat-Sink Thermal Resistance		deg/W
θ _{HS-A}	Heat-Sink-to-Free-Air Thermal Resistance		deg/W
T _A	Free-Air Temperature		°C
T _C	Case Temperature		°C
T _{J(avg)}	Average Junction Temperature	≤ 200	°C
T _{J(max)}	Peak Junction Temperature	≤ 200	°C
K	Peak-Power Coefficient	See Figure 9	
t _p	Pulse Width		ms
t _x	Pulse Period		ms
d	Duty-Cycle Ratio (t _p /t _x)		

Equation No. 1 — Application: d-c power dissipation, heat sink used.

$$P_{T(avg)} = \frac{T_{J(avg)} - T_A}{\theta_{J-C} + \theta_{C-HS} + \theta_{HS-A}} \text{ for } 100^\circ\text{C} \leq T_C \leq 200^\circ\text{C}$$

Equation No. 2 — Application: d-c power dissipation, no heat sink used.

$$P_{T(avg)} = \frac{T_{J(avg)} - T_A}{\theta_{J-A}} \text{ for } 25^\circ\text{C} \leq T_A \leq 200^\circ\text{C}$$

Equation No. 3 — Application: Peak power dissipation, heat sink used.

$$P_{T(max)} = \frac{T_{J(max)} - T_A}{d(\theta_{C-HS} + \theta_{HS-A}) + K\theta_{J-C}} \text{ for } 100^\circ\text{C} \leq T_C \leq 200^\circ\text{C}$$

Equation No. 4 — Application: Peak power dissipation, no heat sink used.

$$P_{T(max)} = \frac{T_{J(max)} - T_A}{d\theta_{C-A} + K\theta_{J-C}} \text{ for } 25^\circ\text{C} \leq T_A \leq 200^\circ\text{C}$$

Example — Find P_{T(max)} (design limit)
OPERATING CONDITIONS:

$$\theta_{C-HS} + \theta_{HS-A} = 1.3 \text{ deg/W (From information supplied with heat sink.)}$$

$$\begin{aligned} T_{J(avg)} \text{ (design limit)} &= 200^\circ\text{C} \\ T_A &= 50^\circ\text{C} \\ d &= 10\% \text{ (0.1)} \\ t_p &= 0.1 \text{ ms} \end{aligned}$$

Solution:

From Figure 9, Peak-Power Coefficient

$$K = 0.101 \text{ and by use of equation No. 3}$$

$$P_{T(max)} = \frac{T_{J(max)} - T_A}{d(\theta_{C-HS} + \theta_{HS-A}) + K\theta_{J-C}}$$

$$P_{T(max)} = \frac{200 - 50}{0.1(1.3) + 0.101(2)} = 450 \text{ W}$$

TYPE 2N5333 P-N-P EPITAXIAL PLANAR SILICON POWER TRANSISTOR



TYPE 2N5333
BULLETIN NO. DLS-689281, MARCH 1968

FOR POWER-AMPLIFIER AND HIGH-SPEED-SWITCHING APPLICATIONS DESIGNED FOR COMPLEMENTARY USE WITH 2N4300

- 15 W at 100°C Case Temperature
- Max $V_{CE(sat)}$ of 0.45 V at 1 A I_C
- Typ t_{on} of 150 ns at 1 A I_C
- Min f_T of 30 MHz

***mechanical data**

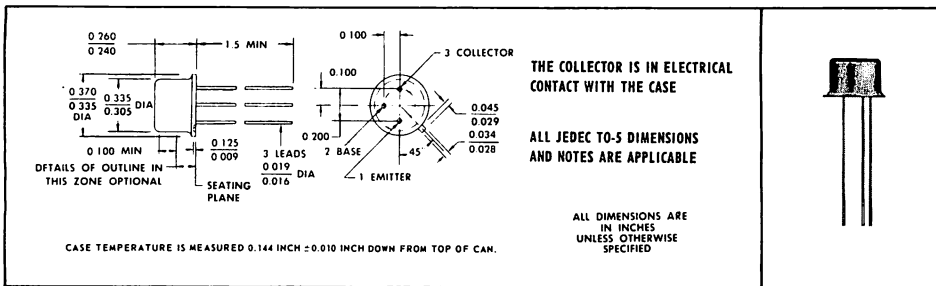

***absolute maximum ratings at 25°C case temperature (unless otherwise noted)**

Collector-Base Voltage	-100 V
Collector-Emitter Voltage (See Note 1)	-80 V
Emitter-Base Voltage	-6 V
Continuous Collector Current	-2 A
Peak Collector Current (See Note 2)	-5 A
Continuous Base Current	-1 A
Continuous Emitter Current	-3 A
Safe Operating Region at (or below) 100°C Case Temperature	See Figure 7
Continuous Device Dissipation at (or below) 100°C Case Temperature (See Note 3)	15 W
Continuous Device Dissipation at (or below) 25°C Free-Air Temperature (See Note 4)	1 W
Operating Collector Junction Temperature Range	-65°C to 200°C
Storage Temperature Range	-65°C to 200°C
Lead Temperature 1/16 Inch from Case for 10 Seconds	260°C

- NOTES: 1. This value applies when the base-emitter diode is open-circuited.
 2. This value applies for $t_p \leq 0.3$ ms, duty cycle $\leq 10\%$.
 3. Derate linearly to 200°C case temperature at the rate of 0.15 W/deg.
 4. Derate linearly to 200°C free-air temperature at the rate of 5.72 mW/deg.

*Indicates JEDEC registered data

TYPE 2N5333

P-N-P EPITAXIAL PLANAR SILICON POWER TRANSISTOR

*electrical characteristics at 25°C case temperature (unless otherwise noted)

PARAMETER	TEST CONDITIONS	MIN	MAX	UNIT
$V_{(BR)CEO}$ Collector-Emitter Breakdown Voltage	$I_C = -30 \text{ mA}$, $I_B = 0$, See Note 5	-80		V
I_{CEO} Collector Cutoff Current	$V_{CE} = -40 \text{ V}$, $I_B = 0$		-50	μA
I_{CES} Collector Cutoff Current	$V_{CE} = -90 \text{ V}$, $V_{BE} = 0$		-10	μA
	$V_{CE} = -50 \text{ V}$, $V_{BE} = 0$, $T_C = 150^\circ\text{C}$		-500	
I_{EBO} Emitter Cutoff Current	$V_{EB} = -4 \text{ V}$, $I_C = 0$		-1	μA
	$V_{EB} = -6 \text{ V}$, $I_C = 0$		-100	
h_{FE} Static Forward Current Transfer Ratio	$V_{CE} = -4 \text{ V}$, $I_C = -1 \text{ A}$, See Notes 5 and 6	30	120	
	$V_{CE} = -4 \text{ V}$, $I_C = -2 \text{ A}$, See Notes 5 and 6	10		
V_{BE} Base-Emitter Voltage	$V_{CE} = -4 \text{ V}$, $I_C = -2 \text{ A}$, See Notes 5 and 6		-1.5	V
$V_{CE(sat)}$ Collector-Emitter Saturation Voltage	$I_B = -0.1 \text{ A}$, $I_C = -1 \text{ A}$, See Notes 5 and 6		-0.45	V
	$I_B = -0.4 \text{ A}$, $I_C = -2 \text{ A}$, See Notes 5 and 6		-1	
h_{fe} Small-Signal Common-Emitter Forward Current Transfer Ratio	$V_{CE} = -10 \text{ V}$, $I_C = -1 \text{ A}$, $f = 1 \text{ kHz}$	30		
$ h_{fe} $ Small-Signal Common-Emitter Forward Current Transfer Ratio	$V_{CE} = -10 \text{ V}$, $I_C = -1 \text{ A}$, $f = 15 \text{ MHz}$	2		

NOTES: 5. These parameters must be measured using pulse techniques. $I_p = 300 \mu\text{s}$, duty cycle $\leq 2\%$.

6. These parameters are measured with voltage-sensing contacts separate from the current-carrying contacts.

*thermal characteristics

PARAMETER	MAX	UNIT
θ_{J-C} Junction-to-Case Thermal Resistance	6.66	deg/W
θ_{J-A} Junction-to-Free-Air Thermal Resistance	175	

*Indicates JEDEC registered data

TYPE 2N5333

P-N-P EPITAXIAL PLANAR SILICON POWER TRANSISTOR

switching characteristics at 25°C case temperature

PARAMETER	TEST CONDITIONS†	TYP	UNIT
t_{on} Turn-On Time	$I_C = -1 \text{ A}$, $I_{B(1)} = -0.1 \text{ A}$, $I_{B(2)} = 0.1 \text{ A}$, $V_{BE(off)} = 3.7 \text{ V}$, $R_L = 20 \Omega$, See Figure 1	150	ns
t_{off} Turn-Off Time		450	

†Voltage and current values shown are nominal; exact values vary slightly with transistor parameters.

PARAMETER MEASUREMENT INFORMATION

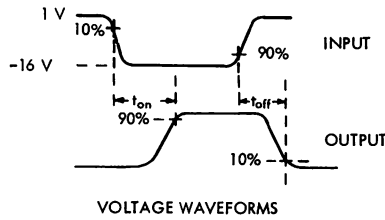
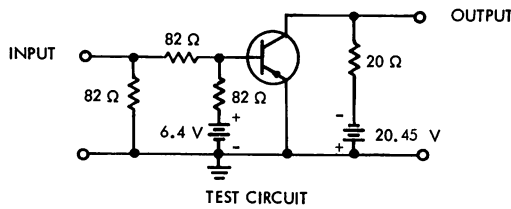

FIGURE 1

- NOTES:
- The input waveform is supplied by a generator with the following characteristics: $t_r \leq 15 \text{ ns}$, $t_f \leq 15 \text{ ns}$, $Z_{out} = 50 \Omega$, $t_p = 2 \mu\text{s}$, duty cycle $\leq 2\%$.
 - Waveforms are monitored on an oscilloscope with the following characteristics: $t_r \leq 15 \text{ ns}$, $R_{in} \geq 10 \text{ M}\Omega$, $C_{in} \leq 11.5 \text{ pF}$.
 - Resistors must be noninductive types.
 - The d-c power supplies may require additional bypassing in order to minimize ringing.

TYPE 2N5333

P-N-P EPITAXIAL PLANAR SILICON POWER TRANSISTOR

TYPICAL CHARACTERISTICS

STATIC FORWARD CURRENT TRANSFER RATIO
vs
COLLECTOR CURRENT

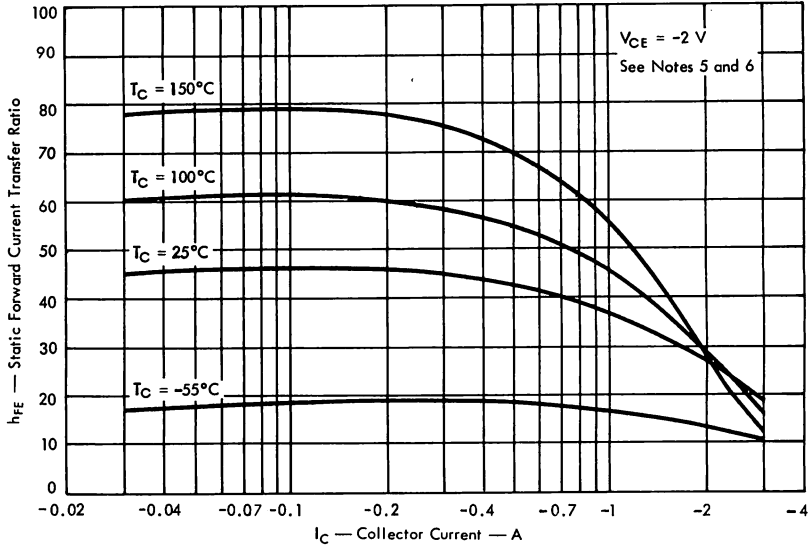

FIGURE 2

BASE-EMITTER VOLTAGE
vs
CASE TEMPERATURE

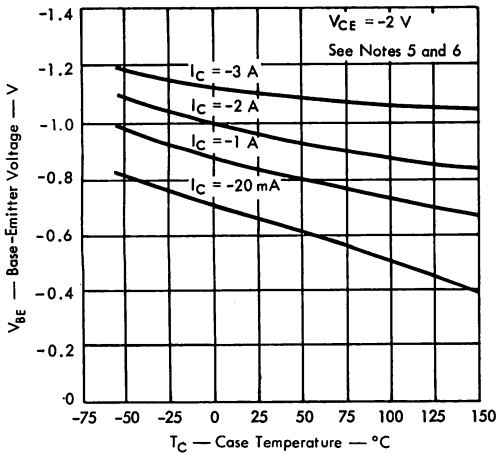

FIGURE 3

COLLECTOR-EMITTER SATURATION VOLTAGE
vs
CASE TEMPERATURE

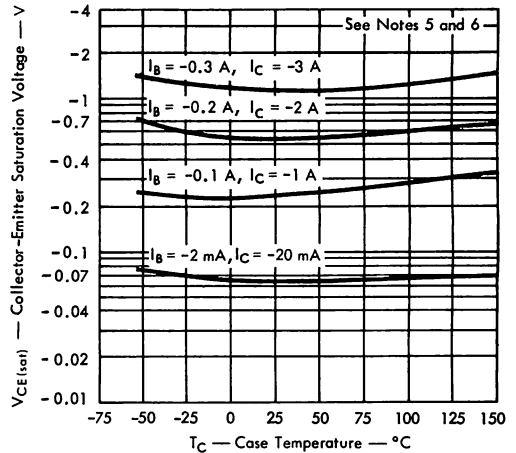

FIGURE 4

- NOTES: 5. These parameters must be measured using pulse techniques. $I_p = 300 \mu s$, duty cycle $\leq 2\%$.
6. These parameters are measured with voltage-sensing contacts separate from the current-carrying contacts.

TYPE 2N5333 P-N-P EPITAXIAL PLANAR SILICON POWER TRANSISTOR

TYPICAL CHARACTERISTICS

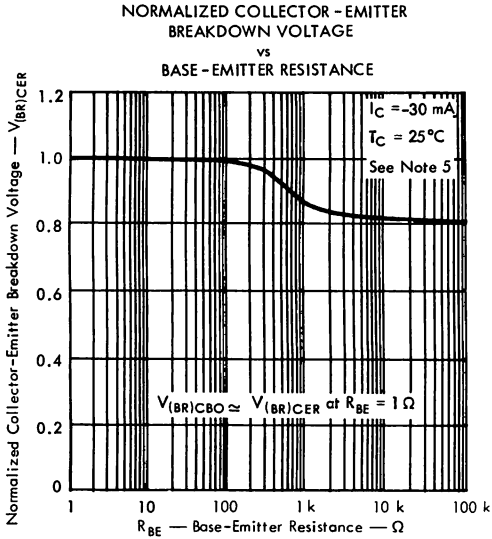

FIGURE 5

NOTE 5: These parameters must be measured using pulse techniques. $t_p = 300 \mu s$, duty cycle $\leq 2\%$.

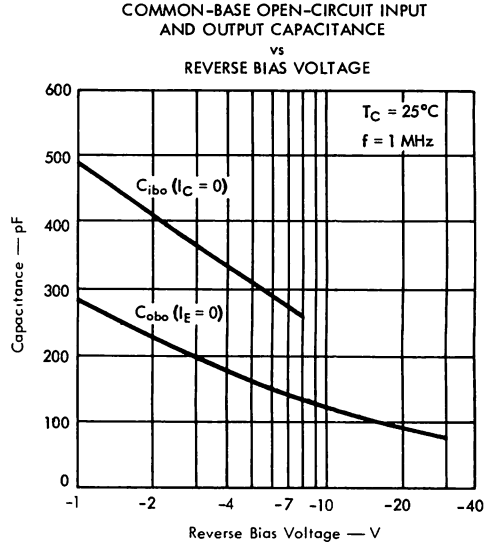

FIGURE 6

MAXIMUM SAFE OPERATING REGION

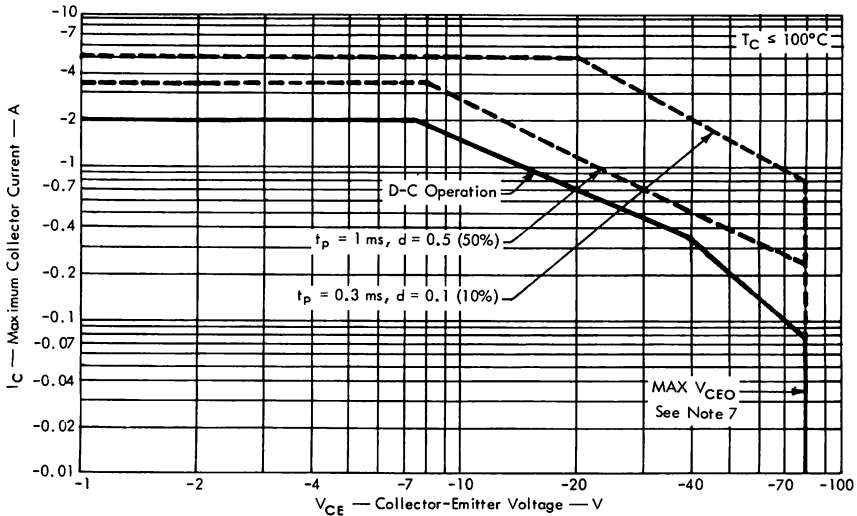

FIGURE 7

NOTE 7: Operation above maximum V_{CEO} is permissible if the base is reverse-voltage biased with respect to the emitter and the collector-base-voltage rating is not exceeded.

TYPE 2N5333

P-N-P EPITAXIAL PLANAR SILICON POWER TRANSISTOR

THERMAL INFORMATION

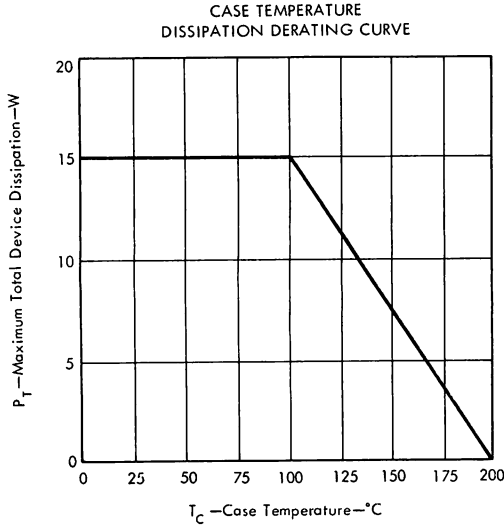

FIGURE 8

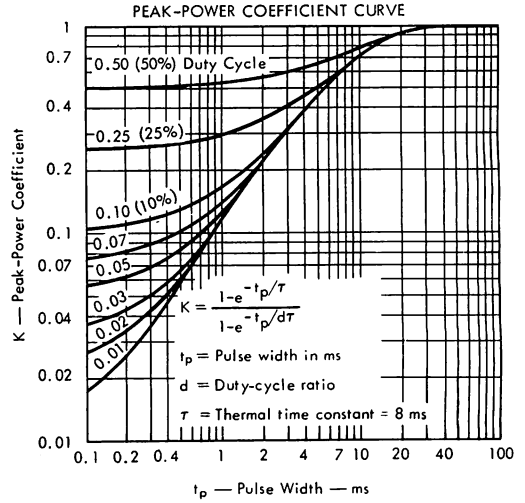

FIGURE 9

SYMBOL DEFINITION

SYMBOL	DEFINITION	VALUE	UNIT
$P_{T(av)}$	Average Power Dissipation		W
$P_{T(max)}$	Peak Power Dissipation		W
θ_{J-A}	Junction-to-Free-Air Thermal Resistance	175	deg/W
θ_{J-C}	Junction-to-Case Thermal Resistance	6.66	deg/W
θ_{C-A}	Case-to-Free-Air Thermal Resistance	168	deg/W
θ_{C-HS}	Case-to-Heat-Sink Thermal Resistance		deg/W
θ_{HS-A}	Heat-Sink-to-Free-Air Thermal Resistance		deg/W
T_A	Free-Air Temperature		$^{\circ}C$
T_C	Case Temperature		$^{\circ}C$
$T_{J(av)}$	Average Junction Temperature	≤ 200	$^{\circ}C$
$T_{J(max)}$	Peak Junction Temperature	≤ 200	$^{\circ}C$
K	Peak-Power Coefficient	See Figure 9	
t_p	Pulse Width		ms
t_x	Pulse Period		ms
d	Duty-Cycle Ratio (t_p/t_x)		

Example — Find $P_{T(max)}$ (design limit)

OPERATING CONDITIONS:

$$\theta_{C-HS} + \theta_{HS-A} = 7 \text{ deg/W (From information supplied with heat sink.)}$$

$$T_{J(av)} \text{ (design limit)} = 200^{\circ}C$$

$$T_A = 50^{\circ}C$$

$$d = 10\% (0.1)$$

$$t_p = 0.1 \text{ ms}$$

Equation No. 1 — Application: d-c power dissipation, heat sink used.

$$P_{T(av)} = \frac{T_{J(av)} - T_A}{\theta_{J-C} + \theta_{C-HS} + \theta_{HS-A}} \text{ for } 100^{\circ}C \leq T_C \leq 200^{\circ}C \text{ as in Figure 8}$$

Equation No. 2 — Application: d-c power dissipation, no heat sink used.

$$P_{T(av)} = \frac{T_{J(av)} - T_A}{\theta_{J-A}} \text{ for } 25^{\circ}C \leq T_A \leq 200^{\circ}C$$

Equation No. 3 — Application: Peak power dissipation, heat sink used.

$$P_{T(max)} = \frac{T_{J(max)} - T_A}{d(\theta_{C-HS} + \theta_{HS-A}) + K \theta_{J-C}} \text{ for } 100^{\circ}C \leq T_C \leq 200^{\circ}C$$

Equation No. 4 — Application: Peak power dissipation, no heat sink used.

$$P_{T(max)} = \frac{T_{J(max)} - T_A}{d \theta_{C-A} + K \theta_{J-C}} \text{ for } 25^{\circ}C \leq T_A \leq 200^{\circ}C$$

Solution:

From Figure 9, Peak-Power Coefficient

$$K = 0.105 \text{ and by use of equation No. 3}$$

$$P_{T(max)} = \frac{T_{J(max)} - T_A}{d(\theta_{C-HS} + \theta_{HS-A}) + K \theta_{J-C}}$$

$$P_{T(max)} = \frac{200 - 50}{0.1 (7) + 0.105 (6.66)} = 107 \text{ W}$$

TYPES 2N5384, 2N5385 P-N-P EPITAXIAL PLANAR SILICON POWER TRANSISTORS



TYPES 2N5384, 2N5385
BULLETIN NO. DL-5 689279, MARCH 1968

**FOR POWER-AMPLIFIER AND HIGH-SPEED-SWITCHING APPLICATIONS
DESIGNED FOR COMPLEMENTARY USE WITH 2N3996 AND 2N3998**

- 30 W at 100°C Case Temperature
- Typ t_{on} of 160 ns at 2 A I_c
- Max $V_{CE(sat)}$ of 0.6 V at 2 A I_c
- Min f_T of 30 MHz

***mechanical data**

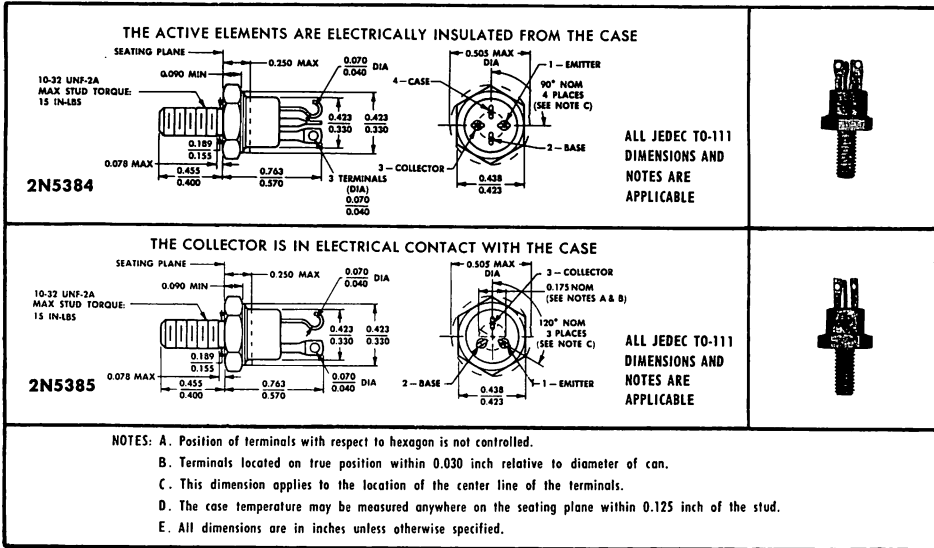

***absolute maximum ratings at 25°C case temperature (unless otherwise noted)**

Collector-Base Voltage	-100 V
Collector-Emitter Voltage (See Note 1)	-80 V
Emitter-Base Voltage	-6 V
Continuous Collector Current	-5 A
Peak Collector Current (See Note 2)	-12 A
Continuous Base Current	-1 A
Continuous Emitter Current	-6 A
Safe Operating Region at (or below) 100°C Case Temperature	See Figure 2
Continuous Device Dissipation at (or below) 100°C Case Temperature (See Note 3)	30 W
Continuous Device Dissipation at (or below) 25°C Free-Air Temperature (See Note 4)	2 W
Operating Collector Junction Temperature Range	-65°C to 200°C
Storage Temperature Range	-65°C to 200°C
Terminal Temperature 1/16 Inch from Case for 10 Seconds	260°C

- NOTES: 1. This value applies when the base-emitter diode is open-circuited.
 2. This value applies for $t_p \leq 0.3$ ms, duty cycle $\leq 10\%$.
 3. Derate linearly to 200°C case temperature at the rate of 0.3 W/deg.
 4. Derate linearly to 200°C free-air temperature at the rate of 11.4 mW/deg.

*Indicates JEDEC registered data

TYPES 2N5384, 2N5385

P-N-P EPITAXIAL PLANAR SILICON POWER TRANSISTORS

*electrical characteristics at 25°C case temperature (unless otherwise noted)

PARAMETER	TEST CONDITIONS	MIN	MAX	UNIT
$V_{(BR)CEO}$ Collector-Emitter Breakdown Voltage	$I_C = -30 \text{ mA}$, $I_B = 0$, See Note 5	-80		V
I_{CEO} Collector Cutoff Current	$V_{CE} = -40 \text{ V}$, $I_B = 0$		-50	μA
I_{CES} Collector Cutoff Current	$V_{CE} = -90 \text{ V}$, $V_{BE} = 0$		-10	μA
	$V_{CE} = -50 \text{ V}$, $V_{BE} = 0$, $T_C = 150^\circ\text{C}$		-500	
I_{EBO} Emitter Cutoff Current	$V_{EB} = -4 \text{ V}$, $I_C = 0$		-1	μA
	$V_{EB} = -6 \text{ V}$, $I_C = 0$		-100	
h_{FE} Static Forward Current Transfer Ratio	$V_{CE} = -4 \text{ V}$, $I_C = -2 \text{ A}$, See Notes 5 and 6	20	80	
	$V_{CE} = -4 \text{ V}$, $I_C = -5 \text{ A}$, See Notes 5 and 6	10		
V_{BE} Base-Emitter Voltage	$V_{CE} = -4 \text{ V}$, $I_C = -5 \text{ A}$, See Notes 5 and 6		-1.5	V
$V_{CE(sat)}$ Collector-Emitter Saturation Voltage	$I_B = -0.2 \text{ A}$, $I_C = -2 \text{ A}$, See Notes 5 and 6		-0.6	V
	$I_B = -1 \text{ A}$, $I_C = -5 \text{ A}$, See Notes 5 and 6		-1.4	
h_{fo} Small-Signal Common-Emitter Forward Current Transfer Ratio	$V_{CE} = -10 \text{ V}$, $I_C = -1 \text{ A}$, $f = 1 \text{ kHz}$	20		
$ h_{fo} $ Small-Signal Common-Emitter Forward Current Transfer Ratio	$V_{CE} = -10 \text{ V}$, $I_C = -1 \text{ A}$, $f = 15 \text{ MHz}$	2		

NOTES: 5. These parameters must be measured using pulse techniques. $t_p = 300 \mu\text{s}$, duty cycle $\leq 2\%$.

6. These parameters are measured with voltage-sensing contacts separate from the current-carrying contacts.

*thermal characteristics

PARAMETER	MAX	UNIT
θ_{J-C} Junction-to-Case Thermal Resistance	3.33	deg/W
θ_{J-A} Junction-to-Free-Air Thermal Resistance	87.5	

*Indicates JEDEC registered data

TYPES 2N5384, 2N5385 P-N-P EPITAXIAL PLANAR SILICON POWER TRANSISTORS

switching characteristics at 25°C case temperature

PARAMETER	TEST CONDITIONS†	TYP	UNIT
t_{on} Turn-On Time	$I_C = -2\text{ A}$, $I_{B(1)} = -150\text{ mA}$, $I_{B(2)} = 150\text{ mA}$,	160	ns
t_{off} Turn-Off Time	$V_{BE(off)} = 2.8\text{ V}$, $R_L = 15\ \Omega$, See Figure 1	550	

†Voltage and current values shown are nominal; exact values vary slightly with transistor parameters.

PARAMETER MEASUREMENT INFORMATION

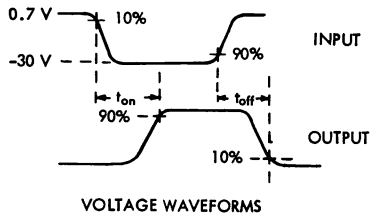
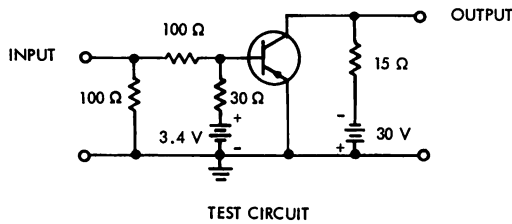

FIGURE 1

- NOTES:
- The input waveform is supplied by a generator with the following characteristics: $t_r \leq 15\text{ ns}$, $t_f \leq 15\text{ ns}$, $Z_{out} = 50\ \Omega$, $t_p = 5\ \mu\text{s}$, duty cycle $\leq 2\%$.
 - Waveforms are monitored on an oscilloscope with the following characteristics: $t_r \leq 15\text{ ns}$, $R_{in} \geq 10\text{ M}\Omega$, $C_{in} \leq 11.5\text{ pF}$.
 - Resistors must be noninductive types.
 - The d-c power supplies may require additional bypassing in order to minimize ringing.

TYPES 2N5384, 2N5385 P-N-P EPITAXIAL PLANAR SILICON POWER TRANSISTORS

MAXIMUM SAFE OPERATING REGION

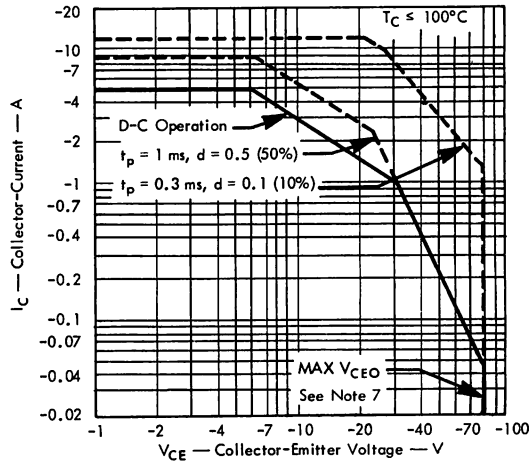

FIGURE 2

NOTE 7: Operation above maximum V_{CE0} is permissible if the base is reverse-voltage-biased with respect to the emitter and the collector-base-voltage rating is not exceeded.

THERMAL CHARACTERISTICS

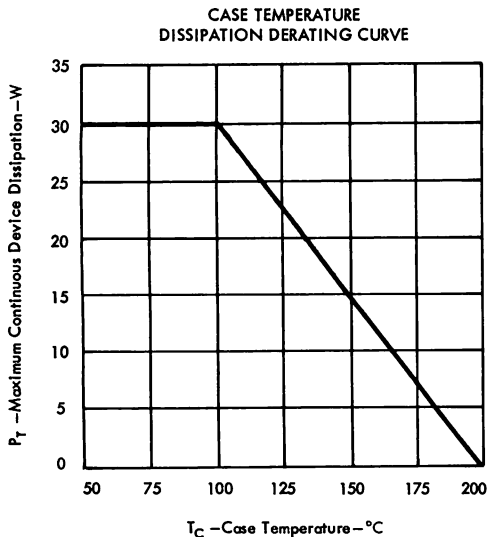

FIGURE 3

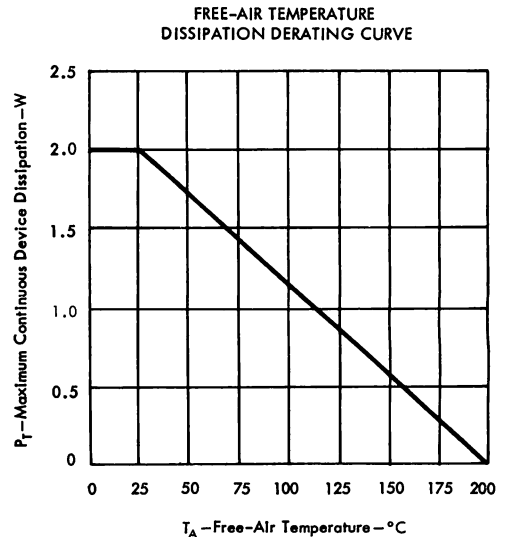

FIGURE 4

TYPE 2N5386 P-N-P EPITAXIAL PLANAR SILICON POWER TRANSISTOR



TYPE 2N5386
BULLETIN NO. DLS-689280, MARCH 1968

**FOR POWER-AMPLIFIER AND HIGH-SPEED-SWITCHING APPLICATIONS
DESIGNED FOR COMPLEMENTARY USE WITH 2N4301**

- 50 W at 100°C Case Temperature
- Max $V_{CE(sat)}$ of 0.6 V at 6 A I_c
- Typ t_{on} of 230 ns at 6 A I_c
- Min f_T of 30 MHz at 10 V, 1 A

***mechanical data**

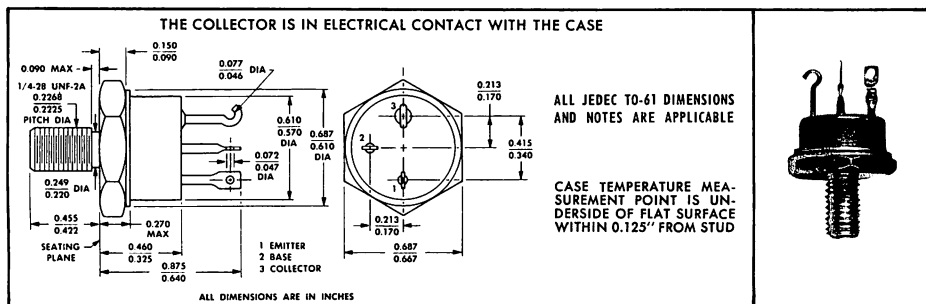

***absolute maximum ratings at 25°C case temperature (unless otherwise noted)**

Collector-Base Voltage	-100 V
Collector-Emitter Voltage (See Note 1)	-80 V
Emitter-Base Voltage	-6 V
Continuous Collector Current	-12 A
Peak Collector Current (See Note 2)	-25 A
Continuous Base Current	-4 A
Continuous Emitter Current	-13 A
Safe Operating Region at (or below) 100°C Case Temperature	See Figure 2
Continuous Device Dissipation at (or below) 100°C Case Temperature (See Note 3)	50 W
Continuous Device Dissipation at (or below) 25°C Free-Air Temperature (See Note 4)	3.5 W
Operating Collector Junction Temperature Range	-65°C to 200°C
Storage Temperature Range	-65°C to 200°C
Terminal Temperature 1/8 Inch from Case for 10 Seconds	260°C

- NOTES: 1. This value applies when the base-emitter diode is open-circuited.
 2. This value applies for $t_p \leq 0.3$ ms, duty cycle $\leq 10\%$.
 3. Derate linearly to 200°C case temperature at the rate of 0.5 W/deg.
 4. Derate linearly to 200°C free-air temperature at the rate of 20 mW/deg.

*Indicates JEDEC registered data

TYPE 2N5386

P-N-P EPITAXIAL PLANAR SILICON POWER TRANSISTOR

*electrical characteristics at 25°C case temperature (unless otherwise noted)

PARAMETER	TEST CONDITIONS	MIN	MAX	UNIT
$V_{(BR)CEO}$ Collector-Emitter Breakdown Voltage	$I_C = -30 \text{ mA}$, $I_B = 0$, See Note 5	-80		V
I_{CEO} Collector Cutoff Current	$V_{CE} = -40 \text{ V}$, $I_B = 0$		-50	μA
I_{CES} Collector Cutoff Current	$V_{CE} = -90 \text{ V}$, $V_{BE} = 0$		-10	μA
	$V_{CE} = -50 \text{ V}$, $V_{BE} = 0$, $T_C = 150^\circ\text{C}$		-500	
I_{EBO} Emitter Cutoff Current	$V_{EB} = -4 \text{ V}$, $I_C = 0$		-5	μA
	$V_{EB} = -6 \text{ V}$, $I_C = 0$		-100	
h_{FE} Static Forward Current Transfer Ratio	$V_{CE} = -4 \text{ V}$, $I_C = -6 \text{ A}$, See Notes 5 and 6	20	80	
	$V_{CE} = -4 \text{ V}$, $I_C = -12 \text{ A}$, See Notes 5 and 6	10		
V_{BE} Base-Emitter Voltage	$V_{CE} = -4 \text{ V}$, $I_C = -12 \text{ A}$, See Notes 5 and 6		-1.5	V
$V_{CE(sat)}$ Collector-Emitter Saturation Voltage	$I_B = -0.6 \text{ A}$, $I_C = -6 \text{ A}$, See Notes 5 and 6		-0.6	V
	$I_B = -2.4 \text{ A}$, $I_C = -12 \text{ A}$, See Notes 5 and 6		-1.4	
h_{fo} Small-Signal Common-Emitter Forward Current Transfer Ratio	$V_{CE} = -10 \text{ V}$, $I_C = -1 \text{ A}$, $f = 1 \text{ kHz}$	20		
$ h_{fo} $ Small-Signal Common-Emitter Forward Current Transfer Ratio	$V_{CE} = -10 \text{ V}$, $I_C = -1 \text{ A}$, $f = 15 \text{ MHz}$	2		

NOTES: 5. These parameters must be measured using pulse techniques. $t_p = 300 \mu\text{s}$, duty cycle $\leq 2\%$.

6. These parameters are measured with voltage-sensing contacts separate from the current-carrying contacts.

*thermal characteristics

PARAMETER	MAX	UNIT
θ_{J-C} Junction-to-Case Thermal Resistance	2	deg /W
θ_{J-A} Junction-to-Free-Air Thermal Resistance	50	

*Indicates JEDEC registered data

TYPE 2N5386

P-N-P EPITAXIAL PLANAR SILICON POWER TRANSISTOR

switching characteristics at 25°C case temperature

PARAMETER	TEST CONDITIONS†	TYP	UNIT
t_{on} Turn-On Time	$I_C = -6\text{ A}, I_{B(1)} = -400\text{ mA}, I_{B(2)} = 400\text{ mA},$ $V_{BE(off)} = 3.6\text{ V}, R_L = 5\ \Omega,$ See Figure 1	230	ns
t_{off} Turn-Off Time		750	

†Voltage and current values shown are nominal; exact values vary slightly with transistor parameters.

PARAMETER MEASUREMENT INFORMATION

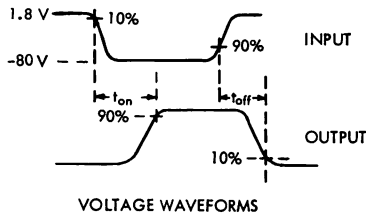
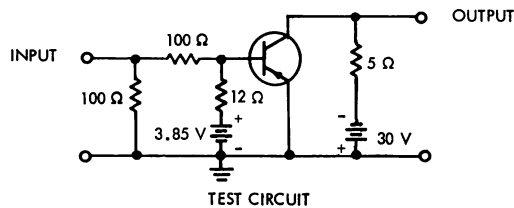

FIGURE 1

- NOTES:
- The input waveform is supplied by a generator with the following characteristics: $t_r \leq 15\text{ ns}, t_f \leq 15\text{ ns}, Z_{out} = 1.5\text{ k}\Omega, t_p = 5\ \mu\text{s},$ duty cycle $\leq 2\%$.
 - Waveforms are monitored on an oscilloscope with the following characteristics: $t_r \leq 15\text{ ns}, R_{in} \geq 10\text{ M}\Omega, C_{in} \leq 11.5\text{ pF}.$
 - Resistors must be noninductive types.
 - The d-c power supplies may require additional bypassing in order to minimize ringing.

TYPE 2N5386

P-N-P EPITAXIAL PLANAR SILICON POWER TRANSISTOR

MAXIMUM SAFE OPERATING REGION

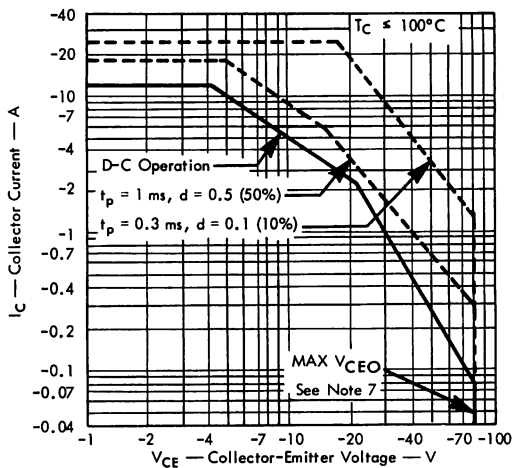

FIGURE 2

NOTE 7: Operation above maximum V_{CEO} is permissible if the base is reverse-voltage-biased with respect to the emitter and the collector-base-voltage rating is not exceeded.

THERMAL CHARACTERISTICS

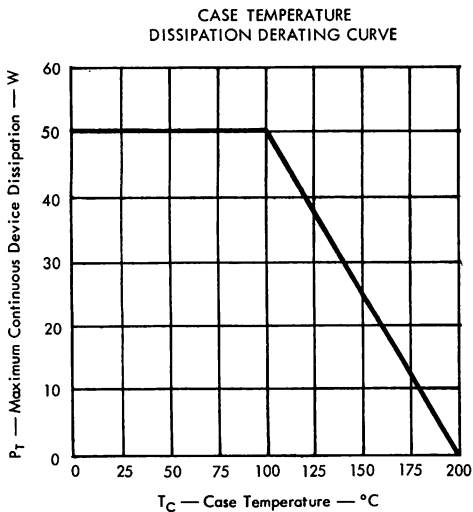

FIGURE 3

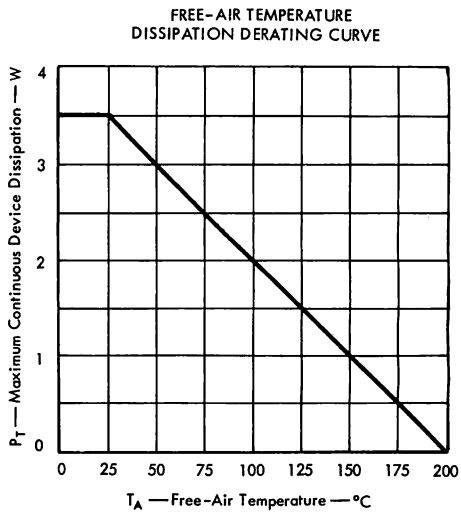

FIGURE 4

TYPES 2N5387, 2N5388, 2N5389 N-P-N TRIPLE-DIFFUSED MESA SILICON POWER TRANSISTORS



TYPES 2N5387, 2N5388, 2N5389
BULLETIN NO. D.L.S. 6810682 MARCH 1968

FOR POWER-AMPLIFIER APPLICATIONS

- 200 V, 250 V, 300 V Rated Collector-Emitter Voltages
- 100 Watts at 100°C Case Temperature
- Typ t_{on} of 300 ns at 2 A I_C
- Min f_T of 15 MHz at 10 V, 1 A

*mechanical data

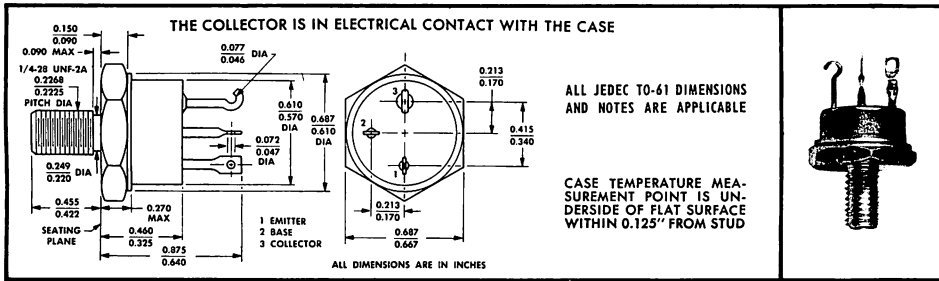

*absolute maximum ratings at 25°C case temperature (unless otherwise noted)

	2N5387	2N5388	2N5389
Collector-Base Voltage	200 V	250 V	300 V
Collector-Emitter Voltage (See Note 1)	200 V	250 V	300 V
Emitter-Base Voltage	← 10 V →		
Continuous Collector Current	← 7.5 A →		
Peak Collector Current (See Note 2)	← 10 A →		
Continuous Base Current	← 3 A →		
Continuous Emitter Current	← 8 A →		
Safe Operating Region at (or below) 100°C Case Temperature	← See Figure 6 →		
Continuous Device Dissipation at (or below) 100°C Case Temperature (See Note 3)	← 100 W →		
Continuous Device Dissipation at (or below) 25°C Free-Air Temperature (See Note 4)	← 3.5 W →		
Operating Collector Junction Temperature Range	← -65°C to 200°C →		
Storage Temperature Range	← -65°C to 200°C →		
Terminal Temperature 1/16 Inch from Case for 10 Seconds	← 260°C →		

- NOTES: 1. This value applies when the base-emitter diode is open-circuited.
 2. This value applies for $t_p \leq 0.3$ ms, duty cycle $\leq 10\%$.
 3. Derate linearly to 200°C case temperature at the rate of 1 W/deg.
 4. Derate linearly to 200°C free-air temperature at the rate of 20 mW/deg.

*Indicates JEDEC registered data



TYPES 2N5387, 2N5388, 2N5389

N-P-N TRIPLE-DIFFUSED MESA SILICON POWER TRANSISTORS

* electrical characteristics at 25°C case temperature (unless otherwise noted)

PARAMETER	TEST CONDITIONS	2N5387		2N5388		2N5389		UNIT
		MIN	MAX	MIN	MAX	MIN	MAX	
$V_{(BR)CEO}$ Collector-Emitter Breakdown Voltage	$I_C = 30 \text{ mA}$, $I_B = 0$, See Note 5	200		250		300		V
I_{CEO} Collector Cutoff Current	$V_{CE} = 180 \text{ V}$, $I_B = 0$		30					mA
	$V_{CE} = 225 \text{ V}$, $I_B = 0$				30			
	$V_{CE} = 270 \text{ V}$, $I_B = 0$						30	
I_{CES} Collector Cutoff Current	$V_{CE} = 180 \text{ V}$, $V_{BE} = 0$		1					mA
	$V_{CE} = 225 \text{ V}$, $V_{BE} = 0$				1			
	$V_{CE} = 270 \text{ V}$, $V_{BE} = 0$						1	
	$V_{CE} = 100 \text{ V}$, $V_{BE} = 0$, $T_C = 150^\circ\text{C}$		10					
	$V_{CE} = 125 \text{ V}$, $V_{BE} = 0$, $T_C = 150^\circ\text{C}$				10			
	$V_{CE} = 150 \text{ V}$, $V_{BE} = 0$, $T_C = 150^\circ\text{C}$						10	
I_{EBO} Emitter Cutoff Current	$V_{EB} = 8 \text{ V}$, $I_C = 0$		0.1		0.1		0.1	mA
	$V_{EB} = 10 \text{ V}$, $I_C = 0$		1		1		1	
h_{FE} Static Forward Current Transfer Ratio	$V_{CE} = 5 \text{ V}$, $I_C = 2 \text{ A}$, See Notes 5 and 6	25	100	25	100	25	100	
	$V_{CE} = 5 \text{ V}$, $I_C = 5 \text{ A}$, See Notes 5 and 6	15		15		15		
	$V_{CE} = 5 \text{ V}$, $I_C = 7 \text{ A}$, See Notes 5 and 6	5		5		5		
V_{BE} Base-Emitter Voltage	$V_{CE} = 5 \text{ V}$, $I_C = 7 \text{ A}$, See Notes 5 and 6		2.5		2.5		2.5	V
$V_{CE(sat)}$ Collector-Emitter Saturation Voltage	$I_B = 1 \text{ A}$, $I_C = 5 \text{ A}$, See Notes 5 and 6		2		2		2	V
	$I_B = 1.4 \text{ A}$, $I_C = 7 \text{ A}$, See Notes 5 and 6		2.2		2.2		2.2	
h_{fe} Small-Signal Common-Emitter Forward Current Transfer Ratio	$V_{CE} = 10 \text{ V}$, $I_C = 1 \text{ A}$, $f = 1 \text{ kHz}$		20		20		20	
$ h_{fe} $ Small-Signal Common-Emitter Forward Current Transfer Ratio	$V_{CE} = 10 \text{ V}$, $I_C = 1 \text{ A}$, $f = 10 \text{ MHz}$		1.5		1.5		1.5	

NOTES: 5. These parameters must be measured using pulse techniques. $t_p = 300 \mu\text{s}$, duty cycle $\leq 2\%$.

6. These parameters are measured with voltage-sensing contacts separate from the current-carrying contacts.

* thermal characteristics

PARAMETER		MAX	UNIT
θ_{J-C}	Junction-to-Case Thermal Resistance	1	deg/W
θ_{J-A}	Junction-to-Free-Air Thermal Resistance	50	

*Indicates JEDEC registered data

TYPES 2N5387, 2N5388, 2N5389 N-P-N TRIPLE-DIFFUSED MESA SILICON POWER TRANSISTORS

switching characteristics at 25°C case temperature

PARAMETER	TEST CONDITIONS†	TYP	UNIT
t_{on} Turn-On Time	$I_C = 2 \text{ A}$, $I_{B(1)} = 200 \text{ mA}$, $I_{B(2)} = -200 \text{ mA}$,	0.3	μs
t_{off} Turn-Off Time	$V_{BE(off)} = -4.7 \text{ V}$, $R_L = 20 \Omega$, See Figure 1	1	

†Voltage and current values shown are nominal; exact values vary slightly with transistor parameters.

PARAMETER MEASUREMENT INFORMATION

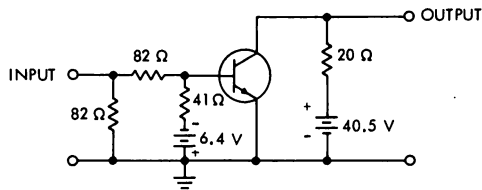

TEST CIRCUIT

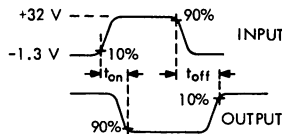

VOLTAGE WAVEFORMS

FIGURE 1

NOTES: a. The input waveform is supplied by a generator with the following characteristics: $t_f \leq 15 \text{ ns}$, $t_r \leq 15 \text{ ns}$, $Z_{out} = 50 \Omega$, $t_p = 10 \mu\text{s}$, duty cycle $\leq 2\%$.

b. Waveforms are monitored on an oscilloscope with the following characteristics: $t_r \leq 15 \text{ ns}$, $R_{in} \geq 10 \text{ M}\Omega$, $C_{in} \leq 11.5 \text{ pF}$.

c. Resistors must be noninductive types.

d. The d-c power supplies may require additional bypassing in order to minimize ringing.

TYPES 2N5387, 2N5388, 2N5389

N-P-N TRIPLE-DIFFUSED MESA SILICON POWER TRANSISTORS

TYPICAL CHARACTERISTICS

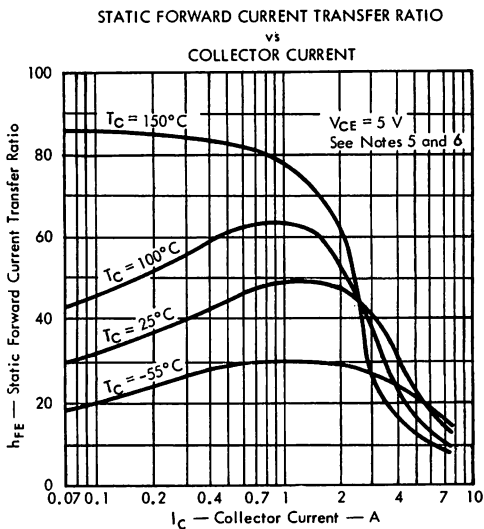

FIGURE 2

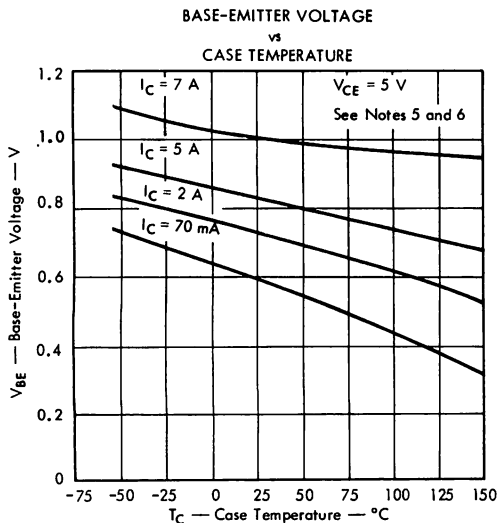

FIGURE 3

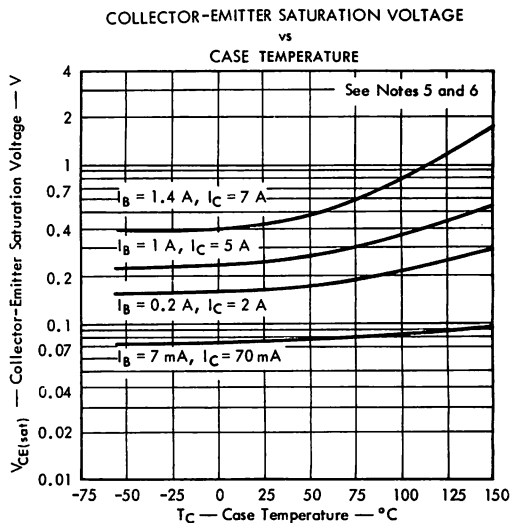

FIGURE 4

NOTES: 5. These parameters must be measured using pulse techniques. $t_p = 300 \mu s$, duty cycle $\leq 2\%$.

6. These parameters are measured with voltage-sensing contacts separate from the current-carrying contacts.

TYPES 2N5387, 2N5388, 2N5389 N-P-N TRIPLE-DIFFUSED MESA SILICON POWER TRANSISTORS

TYPICAL CHARACTERISTICS

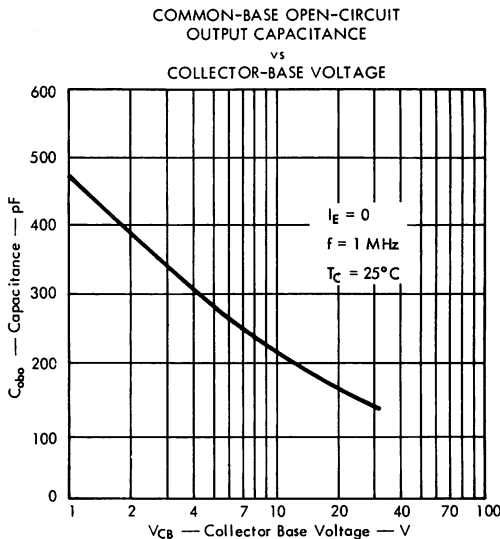

FIGURE 5

MAXIMUM SAFE OPERATING REGION

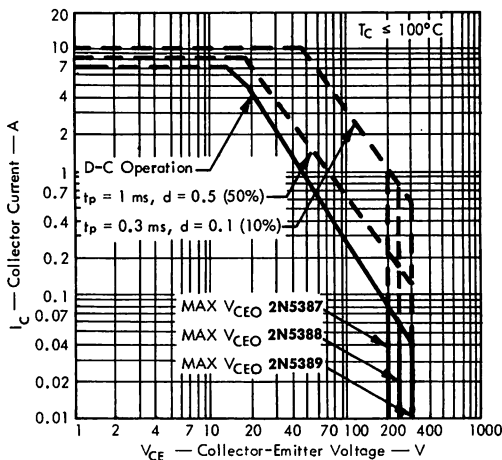

FIGURE 6

NOTE 5: This parameter must be measured using pulse techniques. $t_p = 300 \mu\text{s}$, duty cycle $\leq 2\%$.

TYPES 2N5387, 2N5388, 2N5389

N-P-N TRIPLE-DIFFUSED MESA SILICON POWER TRANSISTORS

THERMAL INFORMATION

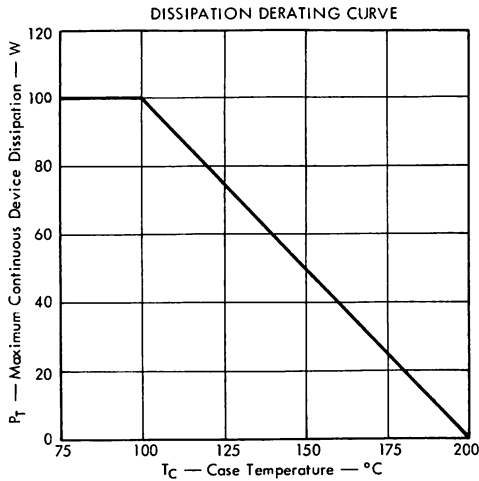

FIGURE 7

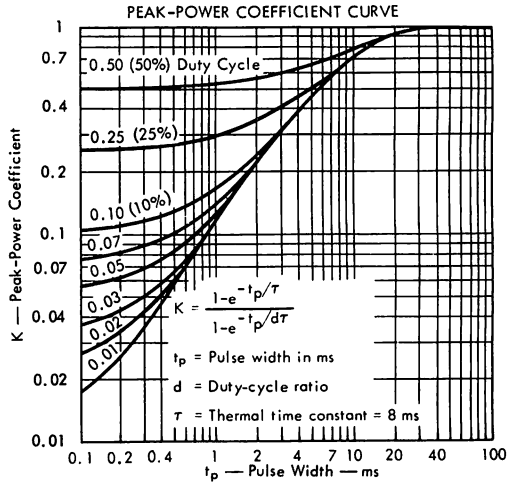

FIGURE 8

SYMBOL DEFINITION

SYMBOL	DEFINITION	VALUE	UNIT
$P_{T(av)}$	Average Power Dissipation		W
$P_{T(max)}$	Peak Power Dissipation		W
θ_{J-A}	Junction-to-Free-Air Thermal Resistance	50	deg/W
θ_{J-C}	Junction-to-Case Thermal Resistance	1	deg/W
θ_{C-A}	Case-to-Free-Air Thermal Resistance	49	deg/W
θ_{C-HS}	Case-to-Heat-Sink Thermal Resistance		deg/W
θ_{HS-A}	Heat-Sink-to-Free-Air Thermal Resistance		deg/W
T_A	Free-Air Temperature		°C
T_C	Case Temperature		°C
$T_{J(av)}$	Average Junction Temperature	≤ 200	°C
$T_{J(max)}$	Peak Junction Temperature	≤ 200	°C
K	Peak-Power Coefficient	See Figure 8	
t_p	Pulse Width		ms
t_x	Pulse Period		ms
d	Duty-Cycle Ratio (t_p/t_x)		

Equation No. 1 — Application: d-c power dissipation, heat sink used.

$$P_{T(av)} = \frac{T_{J(av)} - T_A}{\theta_{J-C} + \theta_{C-HS} + \theta_{HS-A}} \text{ for } 100^\circ\text{C} \leq T_C \leq 200^\circ\text{C} \text{ as in Figure 7}$$

Equation No. 2 — Application: d-c power dissipation, no heat sink used.

$$P_{T(av)} = \frac{T_{J(av)} - T_A}{\theta_{J-A}} \text{ for } 25^\circ\text{C} \leq T_A \leq 200^\circ\text{C}$$

Equation No. 3 — Application: Peak power dissipation, heat sink used.

$$P_{T(max)} = \frac{T_{J(max)} - T_A}{d(\theta_{C-HS} + \theta_{HS-A}) + K\theta_{J-C}} \text{ for } 100^\circ\text{C} \leq T_C \leq 200^\circ\text{C}$$

Equation No. 4 — Application: Peak power dissipation, no heat sink used.

$$P_{T(max)} = \frac{T_{J(max)} - T_A}{d\theta_{C-A} + K\theta_{J-C}} \text{ for } 25^\circ\text{C} \leq T_A \leq 200^\circ\text{C}$$

Example — Find $P_{T(max)}$ (design limit)

OPERATING CONDITIONS:

$$\theta_{C-HS} + \theta_{HS-A} = 4 \text{ deg/W (From information supplied with heat sink.)}$$

$$T_{J(av)} \text{ (design limit)} = 200^\circ\text{C}$$

$$T_A = 50^\circ\text{C}$$

$$d = 10\% (0.1)$$

$$t_p = 0.1 \text{ ms}$$

Solution:

From Figure 8, Peak-Power Coefficient

$K = 0.105$ and by use of equation No. 3.

$$P_{T(max)} = \frac{T_{J(max)} - T_A}{d(\theta_{C-HS} + \theta_{HS-A}) + K\theta_{J-C}}$$

$$P_{T(max)} = \frac{200 - 50}{0.1(4) + 0.106(1)} = 296 \text{ W}$$

TYPES 2N456A, 2N457A, 2N458A, 2N1021 AND 2N1022 P-N-P ALLOY - JUNCTION GERMANIUM POWER TRANSISTORS



CHOICE OF 40v, 60v, 80v, 100v, or 120v DEVICES

LOW I_{CO} HIGH BETA LOW R_{CS}

LOW THERMAL RESISTANCE

150 WATTS DISSIPATION

Designed specifically for High-Voltage Power Converters, High-Voltage Amplifiers and Switching Circuits. Featuring Low Distortion, Low Saturation Resistance and Fast Switching Times.

TYPES 2N456A, 2N457A, 2N458A, 2N1021, and 2N1022
BULLETIN NO. DI-5 611419, MARCH 1961
REPLACES BULLETIN NO. DI-5 60341, MAY 1960

mechanical data

The use of silver alloy to assemble the mounting base and the use of resistance welding to seal the can, provide a hermetically sealed enclosure. During the assembly process the absence of flux, combined with extreme cleanliness, prevents sealed-in contamination.

The mounting base provides an excellent heat path from the collector junction to a heat sink which must be in intimate contact to permit operation at maximum rated dissipation.

The transistors are in a JEDEC TO-3 case.

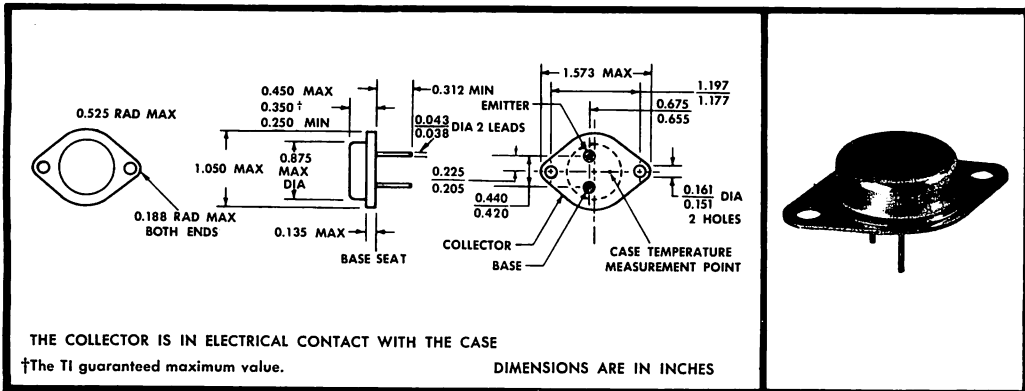

absolute maximum ratings for all devices at 25°C mounting-base temperature (unless otherwise noted)*

Collector Current	7a
Base Current	3a
Total Device Dissipation**	150w
Collector Junction Temperature	100° C
Storage Temperature Range	-55 to +100° C
Thermal Resistance	0.5°C/W

*Maximum voltage ratings not specified because exceeding breakdown voltages will not permanently damage transistor characteristics so long as other maximum ratings are not exceeded.

**Derate at 2 w/°C.



TYPES 2N456A, 2N457A, 2N458A, 2N1021 AND 2N1022 P-N-P ALLOY-JUNCTION GERMANIUM POWER TRANSISTORS

electrical characteristics at 25°C mounting-base temperature

PARAMETER	TYPE	TEST CONDITIONS	MIN	TYP	MAX	UNIT
I_{CBO} Collector Reverse Current	2N456A	$V_{CB} = -40\text{ v}$ $I_E = 0, 25^\circ\text{C}$		-1.0	-2.0	ma
		$V_{CB} = -20\text{ v}$ $I_E = 0, 25^\circ\text{C}$		-0.2	-0.5	ma
		$V_{CB} = -40\text{ v}$ $I_E = 0, 71^\circ\text{C}$		-6.0	-10.0	ma
	2N457A	$V_{CB} = -60\text{ v}$ $I_E = 0, 25^\circ\text{C}$		-1.0	-2.0	ma
		$V_{CB} = -30\text{ v}$ $I_E = 0, 25^\circ\text{C}$		-0.2	-0.5	ma
		$V_{CB} = -60\text{ v}$ $I_E = 0, 71^\circ\text{C}$		-6.0	-10.0	ma
	2N458A	$V_{CB} = -80\text{ v}$ $I_E = 0, 25^\circ\text{C}$		-1.0	-2.0	ma
		$V_{CB} = -40\text{ v}$ $I_E = 0, 25^\circ\text{C}$		-0.2	-0.5	ma
		$V_{CB} = -80\text{ v}$ $I_E = 0, 71^\circ\text{C}$		-6.0	-10.0	ma
	2N1021	$V_{CB} = -100\text{ v}$ $I_E = 0, 25^\circ\text{C}$		-1.0	-2.0	ma
		$V_{CB} = -50\text{ v}$ $I_E = 0, 25^\circ\text{C}$		-0.2	-0.5	ma
		$V_{CB} = -100\text{ v}$ $I_E = 0, 71^\circ\text{C}$		-6.0	-10.0	ma
2N1022	$V_{CB} = -120\text{ v}$ $I_E = 0, 25^\circ\text{C}$		-1.0	-2.0	ma	
	$V_{CB} = -60\text{ v}$ $I_E = 0, 25^\circ\text{C}$		-0.2	-0.5	ma	
	$V_{CB} = -120\text{ v}$ $I_E = 0, 71^\circ\text{C}$		-6.0	-10.0	ma	
I_{EBO} Emitter Reverse Current	All	$V_{EB} = -10\text{ v}$ $I_C = 0$		-0.2		ma
BV_{CBO} Collector-Base Breakdown Voltage	2N456A	$I_C = -2\text{ ma}$ $I_E = 0$	-40			v
	2N457A	$I_C = -2\text{ ma}$ $I_E = 0$	-60			v
	2N458A	$I_C = -2\text{ ma}$ $I_E = 0$	-80			v
	2N1021	$I_C = -2\text{ ma}$ $I_E = 0$	-100			v
	2N1022	$I_C = -2\text{ ma}$ $I_E = 0$	-120			v
BV_{CEO} Collector-Emitter Breakdown Voltage	2N456A	$I_C = -500\text{ ma}$ $I_B = 0$	-30	-40		v
	2N457A	$I_C = -500\text{ ma}$ $I_B = 0$	-40	-50		v
	2N458A	$I_C = -500\text{ ma}$ $I_B = 0$	-45	-55		v
	2N1021	$I_C = -500\text{ ma}$ $I_B = 0$	-50	-60		v
	2N1022	$I_C = -500\text{ ma}$ $I_B = 0$	-55	-60		v
BV_{CER} Collector-Emitter Breakdown Voltage	2N456A	$I_C = -200\text{ ma}$ $R_{BE} = 33\ \Omega$		-50		v
	2N457A	$I_C = -200\text{ ma}$ $R_{BE} = 33\ \Omega$		-60		v
	2N458A	$I_C = -200\text{ ma}$ $R_{BE} = 33\ \Omega$		-67		v
	2N1021	$I_C = -200\text{ ma}$ $R_{BE} = 33\ \Omega$		-73		v
	2N1022	$I_C = -200\text{ ma}$ $R_{BE} = 33\ \Omega$		-78		v
BV_{CES} Collector-Emitter Breakdown Voltage	2N456A	$I_C = -200\text{ ma}$ $V_{BE} = 0$	-50	-60		v
	2N457A	$I_C = -200\text{ ma}$ $V_{BE} = 0$	-60	-70		v
	2N458A	$I_C = -200\text{ ma}$ $V_{BE} = 0$	-65	-78		v
	2N1021	$I_C = -200\text{ ma}$ $V_{BE} = 0$	-70	-85		v
	2N1022	$I_C = -200\text{ ma}$ $V_{BE} = 0$	-75	-90		v
BV_{EBO} Emitter-Base Breakdown Voltage	All	$I_E = -2\text{ ma}$ $I_C = 0$	-20			v
h_{FE} DC Forward Current Transfer Ratio	All	$V_{CE} = -1.5\text{ v}$ $I_C = -7\text{ a}$	22	47		
		$V_{CE} = -1.5\text{ v}$ $I_C = -5\text{ a}$	30	60	90	
		$V_{CE} = -1.5\text{ v}$ $I_C = -3\text{ a}$	35	82		
		$V_{CE} = -1.5\text{ v}$ $I_C = -1\text{ a}$	40	120		

TYPES 2N456A, 2N457A, 2N458A, 2N1021 AND 2N1022 P-N-P ALLOY-JUNCTION GERMANIUM POWER TRANSISTORS

electrical characteristics at 25°C mounting-base temperature

	PARAMETER	TYPE	TEST CONDITIONS	MIN	TYP	MAX	UNIT
V_{BE}	Base-Emitter Voltage	All	$V_{CE} = -1.5 \text{ v}$ $I_C = -7 \text{ a}$		-1.2		v
			$V_{CE} = -1.5 \text{ v}$ $I_C = -5 \text{ a}$		-0.9	-1.5	v
			$V_{CE} = -1.5 \text{ v}$ $I_C = -3 \text{ a}$		-0.6		v
			$V_{CE} = -1.5 \text{ v}$ $I_C = -1 \text{ a}$		-0.35		v
$V_{CE(sat)}$	Collector-Emitter Saturation Voltage	All	$I_B = -700 \text{ ma}$ $I_C = -7 \text{ a}$		-0.3		v
			$I_B = -500 \text{ ma}$ $I_C = -5 \text{ a}$		-0.2	-0.5	v
			$I_B = -300 \text{ ma}$ $I_C = -3 \text{ a}$		-0.1		v
			$I_B = -100 \text{ ma}$ $I_C = -1 \text{ a}$		-0.05		v
Y_{FE}	DC Common-Emitter Forward Transfer Admittance	All	$V_{CE} = -1.5 \text{ v}$ $I_C = -7 \text{ a}$		5.7		mhos
			$V_{CE} = -1.5 \text{ v}$ $I_C = -5 \text{ a}$	3.3	5.5		mhos
			$V_{CE} = -1.5 \text{ v}$ $I_C = -3 \text{ a}$		4.8		mhos
			$V_{CE} = -1.5 \text{ v}$ $I_C = -1 \text{ a}$		3.0		mhos
h_{iE}	DC Common-Emitter Input Impedance	All	$V_{CE} = -1.5 \text{ v}$ $I_C = -7 \text{ a}$		8		ohms
			$V_{CE} = -1.5 \text{ v}$ $I_C = -5 \text{ a}$		11	28	ohms
			$V_{CE} = -1.5 \text{ v}$ $I_C = -3 \text{ a}$		16		ohms
			$V_{CE} = -1.5 \text{ v}$ $I_C = -1 \text{ a}$		42		ohms
f_T	Internal Cutoff Frequency (where $ h_{fe} = 1$)	All	$V_{CE} = -2 \text{ v}$ $I_C = -1 \text{ a}$		430		kc

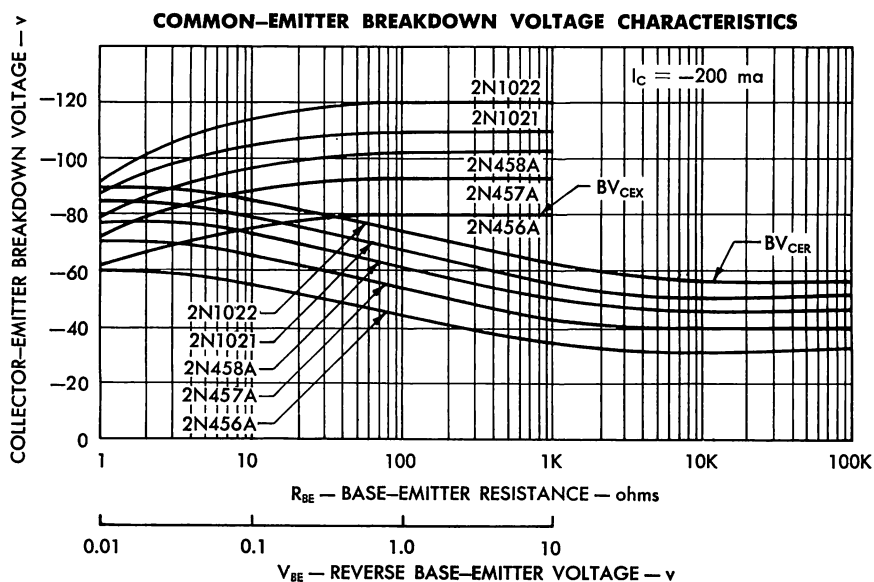

TYPES 2N456A, 2N457A, 2N458A, 2N1021 AND 2N1022 P-N-P ALLOY-JUNCTION GERMANIUM POWER TRANSISTORS

TYPICAL CHARACTERISTICS

COLLECTOR REVERSE-CURRENT CHARACTERISTICS

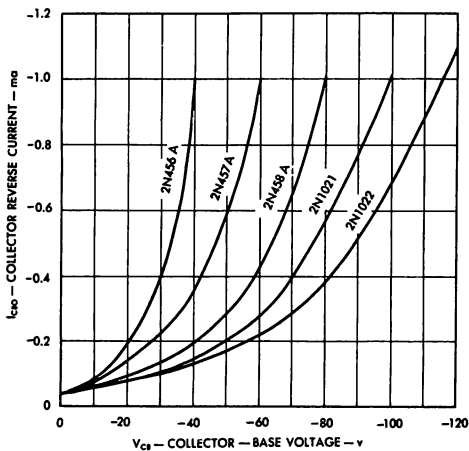

GUARANTEED COMMON-EMITTER DC FORWARD-CURRENT TRANSFER RATIO VS COLLECTOR CURRENT

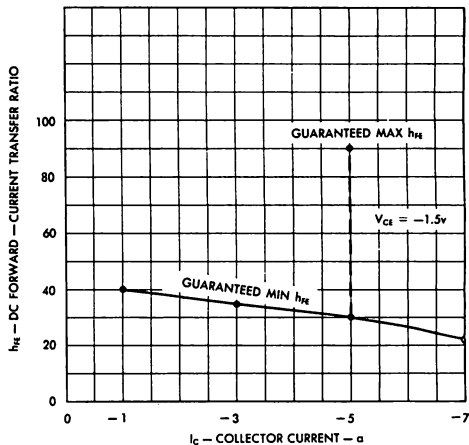

COMMON-EMITTER DC FORWARD CURRENT TRANSFER RATIO, DC INPUT RESISTANCE, AND DC FORWARD TRANSFER ADMITTANCE VS COLLECTOR CURRENT

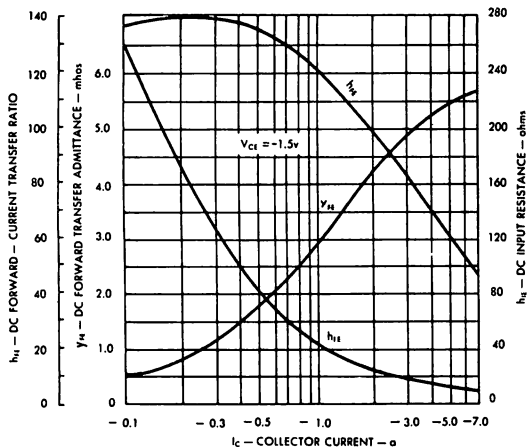

DISSIPATION DERATING

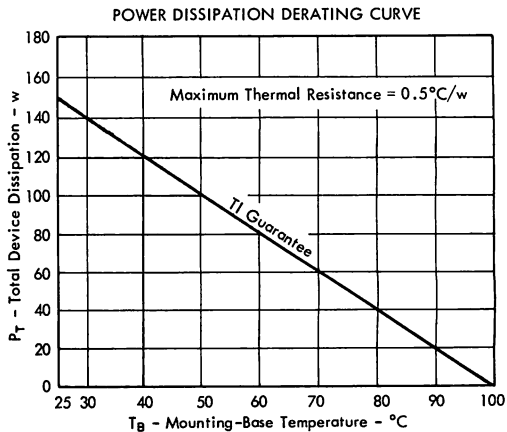

TYPES 2N1038, 2N1039, 2N1040, 2N1041 • 2N2552, 2N2553, 2N2554, 2N2555 • 2N2556, 2N2557, 2N2558, 2N2559 P-N-P ALLOY-JUNCTION GERMANIUM MEDIUM-POWER TRANSISTORS



40-, 60-, 80-, or 100-VOLT UNITS
20 WATTS AT 25°C CASE TEMPERATURE
Choice of TO-5, Stud, or Hex Package
Guaranteed Beta at 1 amp and 50 ma I_C

Guaranteed I_{CEX} at 85°C
LOW r_{CS} • LOW I_{CBO} • LOW V_{BE}
for
RELAY DRIVERS • PULSE AMPLIFIERS
SERVO AMPLIFIERS • AUDIO AMPLIFIERS

TYPES 2N1038 THRU 2N1041, 2N2552 THRU 2N2559
BULLETIN NO. 683397, JULY 1963
REPLACES BULLETIN NO. D.L.S. 60332, MAY 1960
REVISED FEBRUARY 1968

mechanical data

The transistors are in hermetically sealed, resistance-welded cases with glass-to-metal seals between case and leads. These devices are available in (1) a round TO-5 package weighing approximately 2.4 grams (2N1038 series), (2) a stud heat-sink package which weighs approximately 5.4 grams (2N2552 series) and (3) a hexagonal flanged-nut heat-sink package which weighs approximately 8.6 grams (2N2556 series). Mounting hardware available is shown on page 8.

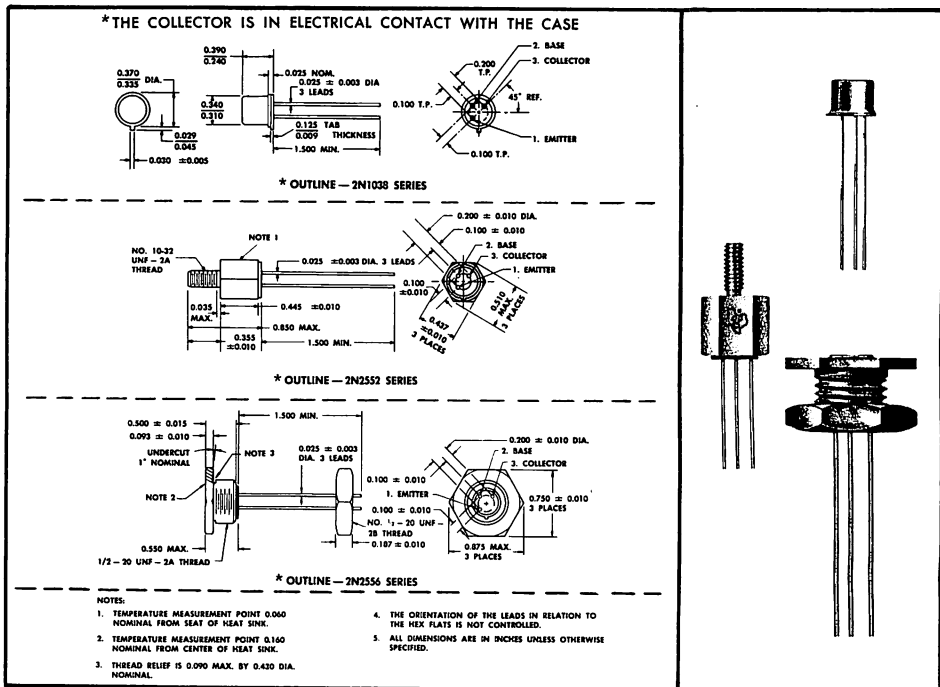

*Indicates JEDEC Registered Data.



TEXAS INSTRUMENTS
INCORPORATED
POST OFFICE BOX 5012 • DALLAS, TEXAS 75222

TYPES 2N1038, 2N1039, 2N1040, 2N1041 • 2N2552, 2N2553, 2N2554, 2N2555 • 2N2556, 2N2557, 2N2558, 2N2559

P-N-P ALLOY-JUNCTION GERMANIUM MEDIUM-POWER TRANSISTORS

*absolute maximum ratings at 25°C case temperature (unless otherwise noted)

	2N1038 2N2552 2N2556	2N1039 2N2553 2N2557	2N1040 2N2554 2N2558	2N1041 2N2555 2N2559
Collector-Base Voltage	40 v	60 v	80 v	100 v
Collector-Emitter Voltage (see Note 1)	40 v	60 v	80 v	100 v
Emitter-Base Voltage	← 20 v →		← 20 v →	
Collector Current	← 3 a →		← 3 a →	
Base Current	← 1 a →		← 1 a →	
Total Device Dissipation at (or below) 25°C				
Case Temperature (see Note 2)	← 20 w →		← 20 w →	
Operating Case Temperature Range	← -55°C to +100°C →		← -55°C to +100°C →	
Storage Temperature Range	← -55°C to +100°C →		← -55°C to +100°C →	

- NOTES: 1. This value applies when base-emitter voltage $V_{BE} = +0.2$ v.
 2. Derate linearly to +100°C case temperature at the rate of 267 mw/C°.

electrical characteristics at 25°C case temperature (unless otherwise noted)

PARAMETER	TEST CONDITIONS	TYPE	MIN	TYP	MAX	UNIT
BV _{CBO} Collector-Base Breakdown Voltage	$I_C = -650 \mu\text{a}, I_E = 0$	2N1038 2N2552 2N2556	-40			v
		2N1039 2N2553 2N2557	-60			
		2N1040 2N2554 2N2558	-80			
		2N1041 2N2555 2N2559	-100			
*BV _{CEO} Collector-Emitter Breakdown Voltage	$I_C = -100 \text{ ma}, I_B = 0$	2N1038 2N2552 2N2556	-30			v
		2N1039 2N2553 2N2557	-40			
		2N1040 2N2554 2N2558	-50			
		2N1041 2N2555 2N2559	-60			

*Indicates JEDEC Registered Data.

**TYPES 2N1038, 2N1039, 2N1040, 2N1041 • 2N2552, 2N2553,
2N2554, 2N2555 • 2N2556, 2N2557, 2N2558, 2N2559
P-N-P ALLOY-JUNCTION GERMANIUM MEDIUM-POWER TRANSISTORS**

electrical characteristics at 25°C case temperature (unless otherwise noted)

PARAMETER	TEST CONDITIONS	TYPE	MIN	TYP	MAX	UNIT
*I _{CBO} Collector Cutoff Current	V _{CB} = -20 v, I _E = 0	2N1038 2N2552 2N2556			-125	μa
	V _{CB} = -30 v, I _E = 0	2N1039 2N2553 2N2557				
	V _{CB} = -40 v, I _E = 0	2N1040 2N2554 2N2558				
	V _{CB} = -50 v, I _E = 0	2N1041 2N2555 2N2559				
*I _{CEO} Collector Cutoff Current	V _{CE} = -15 v, I _B = 0	2N1038 2N2552 2N2556			-25	ma
	V _{CE} = -20 v, I _B = 0	2N1039 2N2553 2N2557			-20	
	V _{CE} = -25 v, I _B = 0	2N1040 2N2554 2N2558			-20	
	V _{CE} = -30 v, I _B = 0	2N1041 2N2555 2N2559			-20	
*I _{CEX} Collector Cutoff Current	V _{CE} = -40 v, V _{BE} = +0.2 v	2N1038 2N2552 2N2556			-650	μa
	V _{CE} = -60 v, V _{BE} = +0.2 v	2N1039 2N2553 2N2557				
	V _{CE} = -80 v, V _{BE} = +0.2 v	2N1040 2N2554 2N2558				
	V _{CE} = -100 v, V _{BE} = +0.2 v	2N1041 2N2555 2N2559				
*I _{CEX} Collector Cutoff Current	V _{CE} = -20 v, V _{BE} = +0.2 v T _C = +85°C	2N1038 2N2552 2N2556			-5	ma
	V _{CE} = -30 v, V _{BE} = +0.2 v T _C = +85°C	2N1039 2N2553 2N2557				
	V _{CE} = -40 v, V _{BE} = +0.2 v T _C = +85°C	2N1040 2N2554 2N2558				
	V _{CE} = -50 v, V _{BE} = +0.2 v T _C = +85°C	2N1041 2N2555 2N2559				
*I _{EBO} Emitter Cutoff Current	V _{EB} = -20 v, I _C = 0	All			-650	μa

*Indicates JEDEC Registered Data.

**TYPES 2N1038, 2N1039, 2N1040, 2N1041 • 2N2552, 2N2553,
2N2554, 2N2555 • 2N2556, 2N2557, 2N2558, 2N2559
P-N-P ALLOY-JUNCTION GERMANIUM MEDIUM-POWER TRANSISTORS**

electrical characteristics at 25°C case temperature (unless otherwise noted)

PARAMETER	TEST CONDITIONS	TYPE	MIN	TYP	MAX	UNIT
h_{iE} Static Common Emitter Input Impedance	$V_{CE} = -0.5 \text{ v}$, $I_C = -1 \text{ a}$ (see Note 3)	All			60	ohm
$*h_{FE}$ Static Forward Current Transfer Ratio	$V_{CE} = -0.5 \text{ v}$, $I_C = -1 \text{ a}$ (see Note 3)	All	20		60	
	$V_{CE} = -0.5 \text{ v}$, $I_C = -50 \text{ ma}$	All	33		200	
h_{FE} Static Forward Current Transfer Ratio	$V_{CE} = -0.5 \text{ v}$, $I_C = -1 \text{ a}$ $T_C = -55^\circ\text{C}$ (See Note 3)	All	15		60	
	$V_{CE} = -0.5 \text{ v}$, $I_C = -1 \text{ a}$ $T_C = +85^\circ\text{C}$	All	20		75	
γ_{FE} Static Common-Emitter Forward Transfer Admittance	$V_{CE} = -0.5 \text{ v}$, $I_C = -1 \text{ a}$ (see Note 3)	All	1.0			mho
$*V_{BE}$ Base-Emitter Voltage	$V_{CE} = -0.5 \text{ v}$, $I_C = -1 \text{ a}$ (see Note 3)	All			-1.0	v
V_{BE} Base-Emitter Voltage	$V_{CE} = -0.5 \text{ v}$, $I_C = -50 \text{ ma}$	All			-0.35	v
$*V_{CE(sat)}$ Collector-Emitter Saturation Voltage	$I_B = -100 \text{ ma}$, $I_C = -1 \text{ a}$ (see Note 3)	All			-0.25	v
$*h_{fo}$ Small-Signal Common-Emitter Forward Current Transfer Ratio	$V_{CE} = -1.5 \text{ v}$, $I_C = -0.5 \text{ a}$ $f = 1 \text{ kc}$	All	18		72	
$* h_{fo} $ Small-Signal Common-Emitter Forward Current Transfer Ratio	$V_{CE} = -1.5 \text{ v}$, $I_C = -0.5 \text{ a}$ $f = 112.5 \text{ kc}$	All	2.0			
C_{ob} Common-Base Open-Circuit Output Capacitance	$V_{CB} = -6 \text{ v}$, $I_E = 0$ $f = 135 \text{ kc}$	All		100		pf

NOTES: 3. Measurements are made with voltage sensing contacts located 0.25 inches from header of transistor.
Voltage sensing contacts are separate from current carrying contacts.

*Indicates JEDEC Registered Data.

switching characteristics at 25°C case temperature

PARAMETER	TEST CONDITIONS†	TYPICAL	UNIT
t_d Delay Time	$I_C = -1 \text{ a}$ $V_{BE(off)} = 7.4 \text{ v}$ $R_L = 29 \Omega$ (See circuit on Page 8)	0.18	μsec
t_r Rise Time		0.47	μsec
t_s Storage Time		0.59	μsec
t_f Fall Time		1.21	μsec
t_T Total Switching Time		2.45	μsec

†Voltage and current values are nominal; exact values vary slightly with device parameters.

**TYPES 2N1038, 2N1039, 2N1040, 2N1041 • 2N2552, 2N2553,
2N2554, 2N2555 • 2N2556, 2N2557, 2N2558, 2N2559**
P-N-P ALLOY-JUNCTION GERMANIUM MEDIUM-POWER TRANSISTORS
TYPICAL CHARACTERISTICS

COMMON-EMITTER COLLECTOR
CHARACTERISTICS
(Low-Voltage Region)

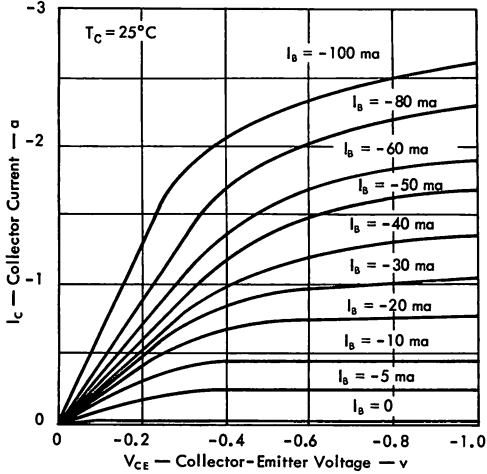

COMMON-EMITTER COLLECTOR
CHARACTERISTICS
(High-Voltage Region)

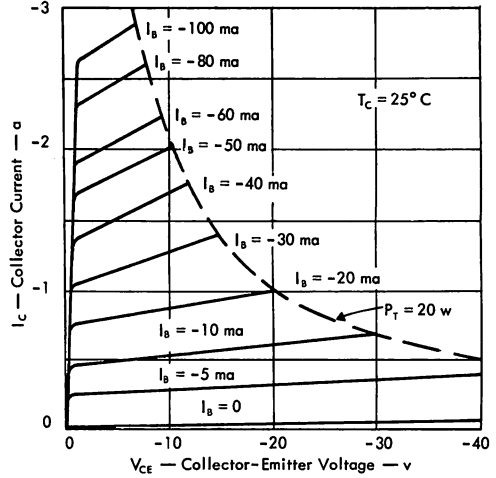

COMMON-EMITTER TRANSFER
CHARACTERISTICS

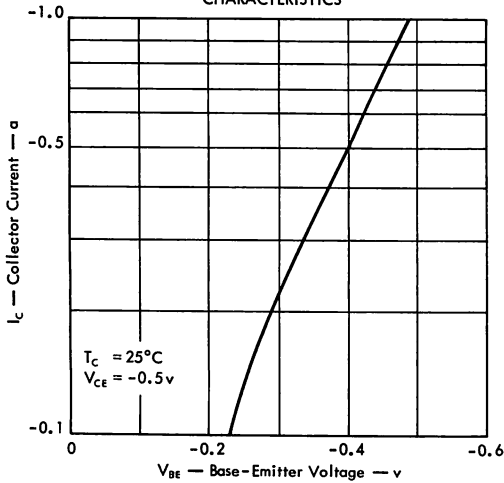

STATIC FORWARD CURRENT TRANSFER RATIO
vs
COLLECTOR CURRENT

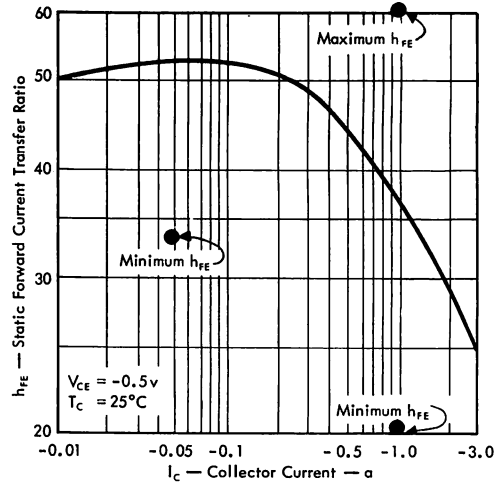

**TYPES 2N1038, 2N1039, 2N1040, 2N1041 • 2N2552, 2N2553,
2N2554, 2N2555 • 2N2556, 2N2557, 2N2558, 2N2559**
P-N-P ALLOY-JUNCTION GERMANIUM MEDIUM-POWER TRANSISTORS
TYPICAL CHARACTERISTICS

STATIC FORWARD CURRENT TRANSFER RATIO
vs
CASE TEMPERATURE

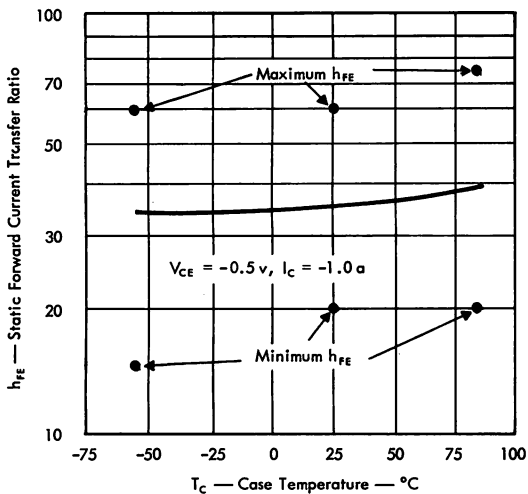

BASE-EMITTER VOLTAGE
vs
CASE TEMPERATURE

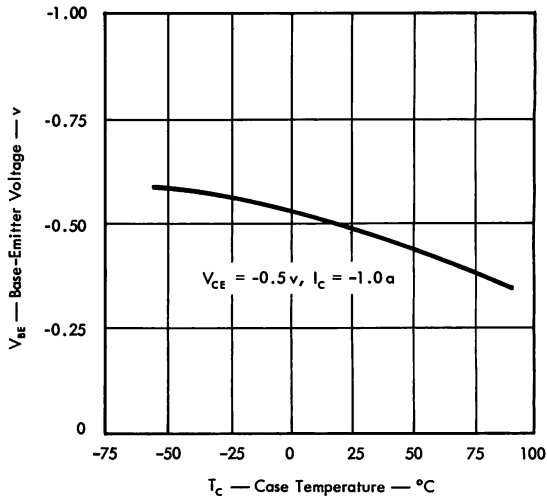

COLLECTOR-EMITTER SATURATION VOLTAGE
vs
CASE TEMPERATURE

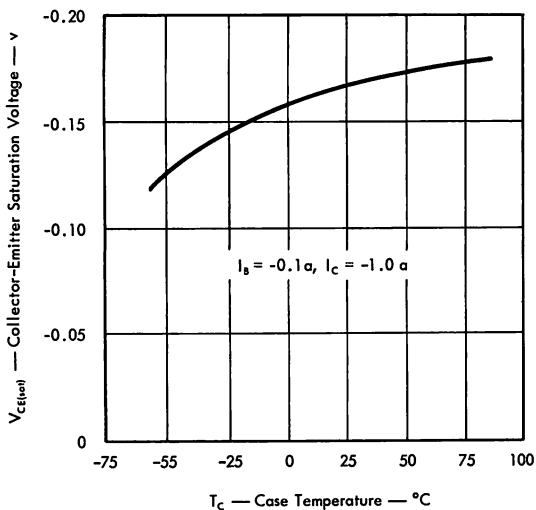

COLLECTOR CUTOFF CURRENT
vs
BASE-EMITTER RESISTANCE
and
BASE-EMITTER VOLTAGE

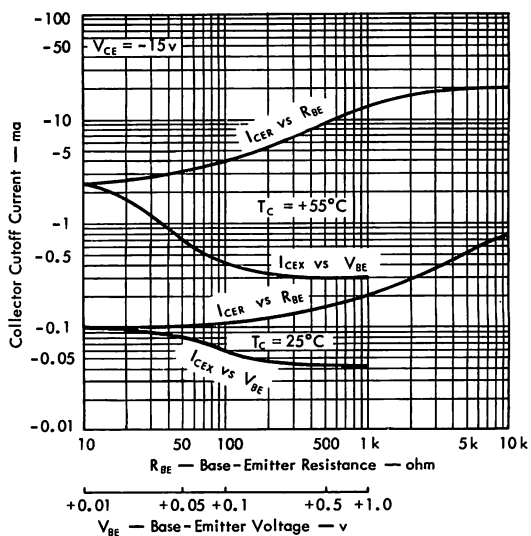

TYPES 2N1038, 2N1039, 2N1040, 2N1041 • 2N2552, 2N2553, 2N2554, 2N2555 • 2N2556, 2N2557, 2N2558, 2N2559

P-N-P ALLOY-JUNCTION GERMANIUM MEDIUM-POWER TRANSISTORS

TYPICAL CHARACTERISTICS

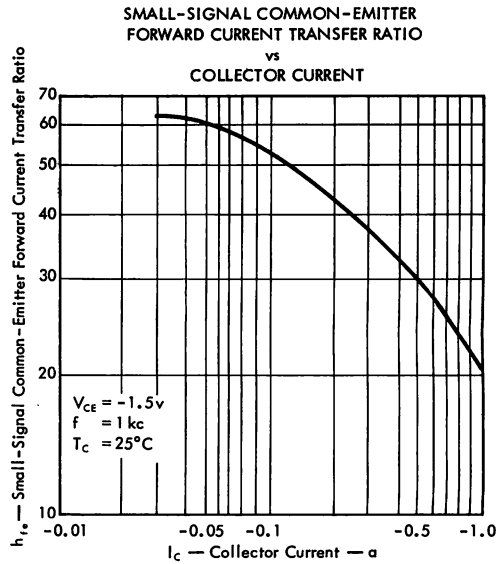
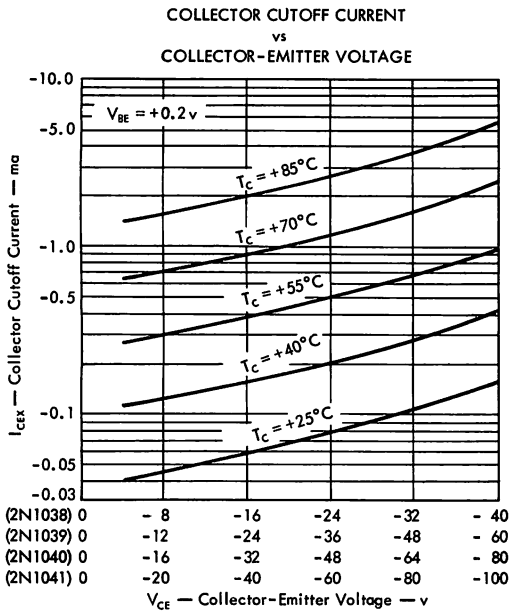

THERMAL CHARACTERISTICS

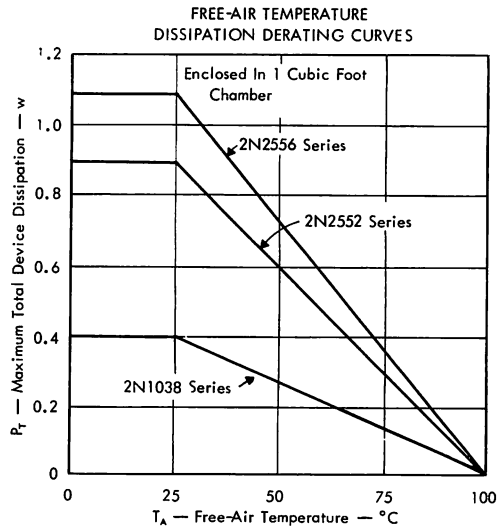
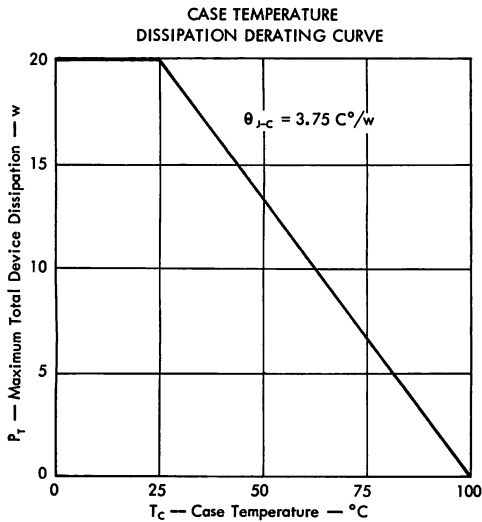

TYPES 2N1038, 2N1039, 2N1040, 2N1041 • 2N2552, 2N2553, 2N2554, 2N2555 • 2N2556, 2N2557, 2N2558, 2N2559

P-N-P ALLOY-JUNCTION GERMANIUM MEDIUM-POWER TRANSISTORS

PARAMETER MEASUREMENT INFORMATION

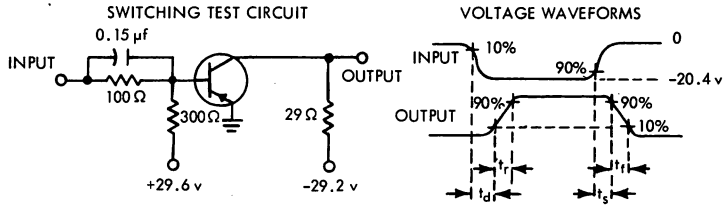

- NOTES: a. The input waveform has the following characteristics: $t_r \leq 10$ nsec, $t_f \leq 10$ nsec, $PW = 1.6$ msec, Duty Cycle = 10%.
 b. Waveforms are monitored on an oscilloscope with the following characteristics: $t_r \leq 14$ nsec, $R_{in} \geq 10$ M Ω, $C_{in} \leq 11.5$ pf.
 c. Resistors must be non-inductive types.

MOUNTING HARDWARE INFORMATION

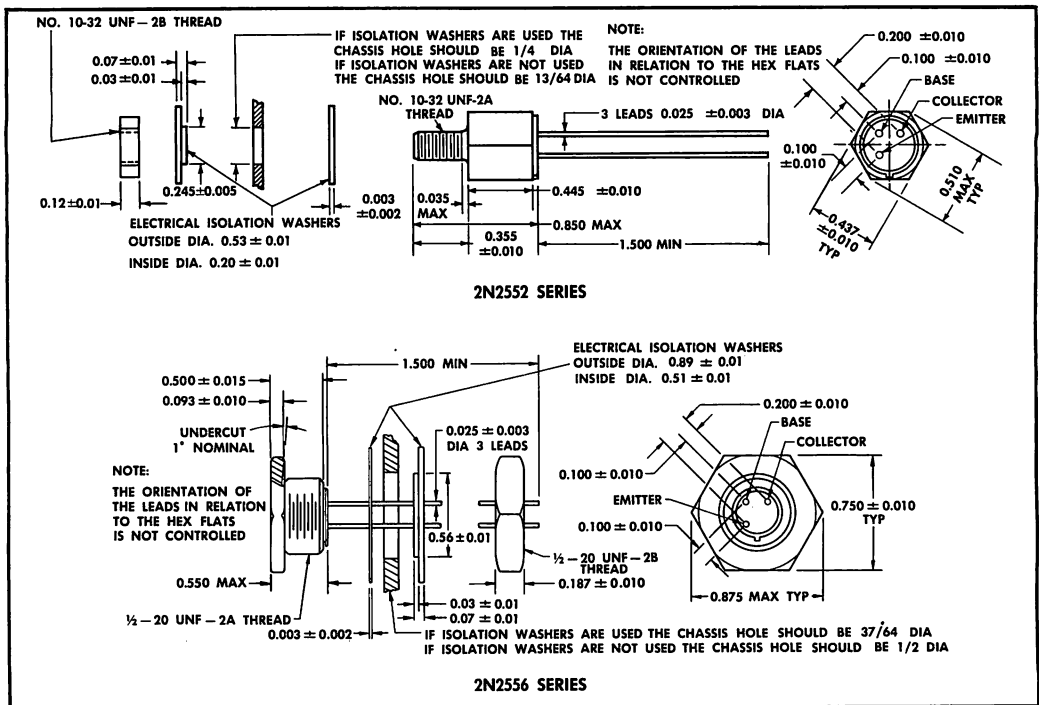

TYPES 2N1539, 2N1540, 2N1541, 2N1542, 2N1543 P-N-P ALLOY-JUNCTION GERMANIUM POWER TRANSISTORS



TYPES 2N1539, 2N1540, 2N1541, 2N1542, 2N1543
BULLETIN NO. DL-5 6353560, FEBRUARY 1963

FOR HIGH-POWER SWITCHING AND AMPLIFIER APPLICATIONS

mechanical data

The use of silver alloy to assemble the mounting base and the use of resistance welding to seal the can, provides a hermetically sealed enclosure. During the assembly process the absence of flux, combined with extreme cleanliness, prevents sealed-in contamination. The mounting base provides an excellent heat path from the collector junction to a heat sink which must be in intimate contact to permit operation at maximum rated dissipation.

*The transistors are in a JEDEC TO-3 case.

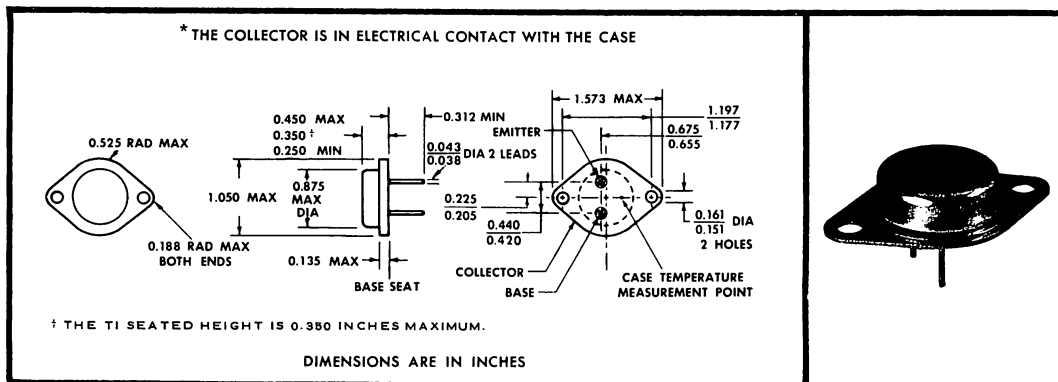

absolute maximum ratings at 25°C case temperature (unless otherwise noted)

	2N1539	2N1540	2N1541	2N1542	2N1543
*Collector-Base Voltage	40v	60v	80v	100v	120v
*Collector-Emitter Voltage (See Note 1)	30v	45v	60v	75v	90v
*Emitter-Base Voltage	20v	30v	40v	50v	60v
*Collector Current	←		5a	→	
*Emitter Current	←		5a	→	
Total Device Dissipation at (or below) 25°C Case Temperature (See Note 2)	←		150w	→	
*Operating Collector Junction Temperature	←		100°C	→	
*Storage Temperature Range	←		-65°C to +100°C	→	

NOTES: 1. This value applies when base-emitter diode is short-circuited.
2. Derate linearly to +100°C case temperature at the rate of 2 w/c°.

*Indicates JEDEC registered data.

TYPES 2N1539, 2N1540, 2N1541, 2N1542, 2N1543

P-N-P ALLOY-JUNCTION GERMANIUM POWER TRANSISTORS

electrical characteristics at 25°C case temperature (unless otherwise noted)

PARAMETER	TEST CONDITIONS	TYPE	MIN	MAX	UNIT
BV_{CBO} Collector-Base Breakdown Voltage	$I_C = -20 \text{ ma}$, $I_E = 0$	2N1539 2N1540 2N1541 2N1542 2N1543	-40 -60 -80 -100 -120		v
* BV_{CEO} Collector-Emitter Breakdown Voltage	$I_C = -500 \text{ ma}$, $I_B = 0$	2N1539 2N1540 2N1541 2N1542 2N1543	-20 -30 -40 -50 -60		v
* BV_{CES} Collector-Emitter Breakdown Voltage	$I_C = -500 \text{ ma}$, $V_{BE} = 0$	2N1539 2N1540 2N1541 2N1542 2N1543	-30 -45 -60 -75 -90		v
* I_{CBO} Collector Cutoff Current	$V_{CB} = -2.0 \text{ v}$, $I_E = 0$	All		-200	μa
* I_{CBO} Collector Cutoff Current	$V_{CB} = -25 \text{ v}$, $I_E = 0$ $V_{CB} = -40 \text{ v}$, $I_E = 0$ $V_{CB} = -55 \text{ v}$, $I_E = 0$ $V_{CB} = -65 \text{ v}$, $I_E = 0$ $V_{CB} = -80 \text{ v}$, $I_E = 0$	2N1539 2N1540 2N1541 2N1542 2N1543		-2.0	ma
* I_{CBO} Collector Cutoff Current	$V_{CB} = -40 \text{ v}$, $I_E = 0$ $V_{CB} = -60 \text{ v}$, $I_E = 0$ $V_{CB} = -80 \text{ v}$, $I_E = 0$ $V_{CB} = -100 \text{ v}$, $I_E = 0$ $V_{CB} = -120 \text{ v}$, $I_E = 0$	2N1539 2N1540 2N1541 2N1542 2N1543		-20	ma
* I_{CBO} Collector Cutoff Current	$V_{CB} = -15 \text{ v}$, $I_E = 0$, $T_C = 90^\circ\text{C}$ $V_{CB} = -22.5 \text{ v}$, $I_E = 0$, $T_C = 90^\circ\text{C}$ $V_{CB} = -30 \text{ v}$, $I_E = 0$, $T_C = 90^\circ\text{C}$ $V_{CB} = -37.5 \text{ v}$, $I_E = 0$, $T_C = 90^\circ\text{C}$ $V_{CB} = -45 \text{ v}$, $I_E = 0$, $T_C = 90^\circ\text{C}$	2N1539 2N1540 2N1541 2N1542 2N1543		-20	ma
* I_{CEX} Collector Cutoff Current	$V_{CE} = -40 \text{ v}$, $V_{BE} = +1.0 \text{ v}$ $V_{CE} = -60 \text{ v}$, $V_{BE} = +1.0 \text{ v}$ $V_{CE} = -80 \text{ v}$, $V_{BE} = +1.0 \text{ v}$ $V_{CE} = -100 \text{ v}$, $V_{BE} = +1.0 \text{ v}$ $V_{CE} = -120 \text{ v}$, $V_{BE} = +1.0 \text{ v}$	2N1539 2N1540 2N1541 2N1542 2N1543		-20	ma
* I_{EBO} Emitter Cutoff Current	$V_{EB} = -12 \text{ v}$, $I_C = 0$	All		-0.5	ma
* I_{EBO} Emitter Cutoff Current	$V_{EB} = -20 \text{ v}$, $I_C = 0$	All		-25	ma
* h_{FE} Static Forward Current Transfer Ratio	$V_{CE} = -2 \text{ v}$, $I_C = -3.0 \text{ a}$	All	50	100	
* g_{FE} Static Common-Emitter Forward Transfer Conductance	$V_{CE} = -2 \text{ v}$, $I_C = -3.0 \text{ a}$	All	3.0		mho
* V_{BE} Base-Emitter Voltage	$I_B = -300 \text{ ma}$, $I_C = -3.0 \text{ a}$	All		-0.7	v
* $V_{CE(sat)}$ Collector-Emitter Saturation Voltage	$I_B = -300 \text{ ma}$, $I_C = -3.0 \text{ a}$	All		-0.3	v
* f_{hfo} Common-Emitter Forward Current Transfer Ratio Cutoff Frequency	$V_{CE} = -2 \text{ v}$, $I_C = -5 \text{ a}$	All	1		kc
f_T Transition Frequency (See Note 3)	$V_{CE} = -2 \text{ v}$, $I_C = -1 \text{ a}$ $f = 100 \text{ kc}$	All	200		kc

thermal characteristics

PARAMETER	TEST CONDITIONS	TYPE	MIN	MAX	UNIT
* θ_{J-C} Junction-to-Case Thermal Resistance		All		0.8	$^\circ\text{C}/\text{w}$

NOTE 3: To obtain f_T , the $|h_{fo}|$ response is extrapolated at the rate of -6 db per octave from $f = 100 \text{ kc}$ to the frequency at which $|h_{fo}| = 1$.

*Indicates JEDEC registered data

TYPES 2N1907, 2N1908 P-N-P ALLOY-DIFFUSED GERMANIUM POWER TRANSISTORS



TYPES 2N1907, 2N1908
 BULLETIN NO. DL-5 644426, FEBRUARY 1964
 REPLACES BULLETIN NO. DL-5 61450, FEBRUARY 1961

HIGH-FREQUENCY POWER TRANSISTORS for MILITARY AND INDUSTRIAL APPLICATIONS

environmental tests

To ensure maximum integrity, stability, and long life, finished transistors are subjected to the following tests and conditions prior to thorough testing for rigid adherence to the specified characteristics.

- All transistors are temperature cycled from -55°C to $+110^{\circ}\text{C}$ for four complete cycles.
- All transistors are heat aged at 110°C for 100 hours minimum.
- The hermetic seal is verified for all devices by the use of both helium and gross leak tests.

Production samples are life tested at regularly scheduled periods to ensure maximum reliability under extreme operating conditions.

mechanical data

These transistors are in precision welded, hermetically sealed enclosures. The mounting base provides an excellent heat path from the collector junction to a heat sink. The mounting base and heat sink must be in intimate contact for maximum heat transfer. Extreme cleanliness during the assembly process prevents sealed-in contamination. The approximate weight of the unit is 18 grams.

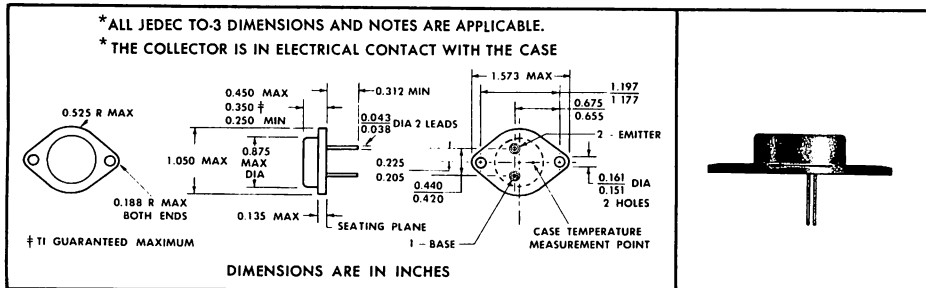

absolute maximum ratings at 25°C case temperature (unless otherwise noted)

	2N1907	2N1908
Collector-Base Voltage	100 v*	130 v*
Collector-Emitter Voltage (See Note 1)	40 v	50 v
Emitter-Base Voltage	← { 1.5 v* } → ← { 2.0 v† } →	
Collector Current	← 20 a* →	
Base Current	← 3 a* →	
Safe Continuous Operating Region	See Figures 15 and 16	
Total Device Dissipation at (or below) 70°C Case Temperature (See Note 2)	← 60 w →	
Peak Collector Power Dissipation at (or below) 25°C Case Temperature (See Note 3)	800 w	1000 w
Operating Collector Junction Temperature	← 100°C^* →	
Storage Temperature Range	{ -55°C to $+100^{\circ}\text{C}^*$ } { -55°C to $+110^{\circ}\text{C}^{\dagger}$ }	

NOTES: 1. This value applies when the base-emitter diode is open-circuited.

2. Derate linearly to 100°C case temperature at the rate of $2 \text{ w}/^{\circ}\text{C}$. This corresponds to the JEDEC registered maximum value of thermal resistance, θ_{J-C} , $0.5 \text{ }^{\circ}\text{C}/\text{w}$.

3. These values apply for rectangular waveshape. See Figure 14 for allowable pulse width and duty cycle combinations. Derate linearly to 100°C case temperature.

*Indicates JEDEC registered data.

†Texas Instruments guarantees this value in addition to the JEDEC registered value which is also shown.



TEXAS INSTRUMENTS
 INCORPORATED
 POST OFFICE BOX 5012 • DALLAS, TEXAS 75222

TYPES 2N1907, 2N1908

P-N-P ALLOY-DIFFUSED GERMANIUM POWER TRANSISTORS

electrical characteristics at 25°C case temperature (unless otherwise noted)

PARAMETER	TEST CONDITIONS	2N1907		2N1908		UNIT
		MIN	MAX	MIN	MAX	
BV_{CBO} Collector-Base Breakdown Voltage	$I_C = -10 \text{ ma}$, $I_E = 0$	-100		-130		v
BV_{CEO} Collector-Emitter Breakdown Voltage	$I_C = -200 \text{ ma}$, $I_B = 0$, See Note 4	-40*		-50*		v
BV_{EBO} Emitter-Base Breakdown Voltage	$I_E = -2 \text{ ma}$, $I_C = 0$	-1.5		-1.5		v
	$I_E = -10 \text{ ma}$, $I_C = 0$	-2.0		-2.0		
I_{CBO} Collector Cutoff Current	$V_{CB} = -3 \text{ v}$, $I_E = 0$	-0.5*				ma
	$V_{CB} = -75 \text{ v}$, $I_E = 0$	-0.3†				
	$V_{CB} = -75 \text{ v}$, $I_E = 0$	-2.0				
	$V_{CB} = -100 \text{ v}$, $I_E = 0$	-10*				
	$V_{CB} = -75 \text{ v}$, $I_E = 0$, $T_C = +70^\circ\text{C}$	-12				
	$V_{CB} = -3 \text{ v}$, $I_E = 0$			-0.5*		
	$V_{CB} = -100 \text{ v}$, $I_E = 0$			-0.3†		
	$V_{CB} = -130 \text{ v}$, $I_E = 0$			-2.0		
I_{CEX} Collector Cutoff Current	$V_{CB} = -100 \text{ v}$, $I_E = 0$, $T_C = +70^\circ\text{C}$			-10*		ma
	$V_{CE} = -75 \text{ v}$, $V_{BE} = +0.2 \text{ v}$	-2.0				
I_{EBO} Emitter Cutoff Current	$V_{CE} = -100 \text{ v}$, $V_{BE} = +0.2 \text{ v}$			-2.0		ma
	$V_{EB} = -0.5 \text{ v}$, $I_C = 0$	-0.2*		-0.2*		
I_{EBO} Emitter Cutoff Current	$V_{EB} = -1.5 \text{ v}$, $I_C = 0$	-0.1†		-0.1†		ma
	$V_{EB} = -1.5 \text{ v}$, $I_C = 0$	-2.0*		-2.0*		
h_{FE} Static Forward Current Transfer Ratio	$V_{CE} = -1.5 \text{ v}$, $I_C = -1 \text{ a}$, See Note 4	80		80		v
	$V_{CE} = -1.5 \text{ v}$, $I_C = -5 \text{ a}$, See Note 4	90		90		
	$V_{CE} = -1.5 \text{ v}$, $I_C = -10 \text{ a}$, See Note 4	30 170		30 170		
	$V_{CE} = -1.5 \text{ v}$, $I_C = -15 \text{ a}$, See Note 4	20		20		
	$V_{CE} = -1.5 \text{ v}$, $I_C = -10 \text{ a}$, $T_C = -55^\circ\text{C}$, See Note 4	30		30		
	$V_{CE} = -1.5 \text{ v}$, $I_C = -10 \text{ a}$, $T_C = +70^\circ\text{C}$, See Note 4	15 100		15 100		
V_{BE} Base-Emitter Voltage	$I_B = -100 \text{ ma}$, $I_C = -1 \text{ a}$, See Note 4	-0.4		-0.4		v
	$I_B = -500 \text{ ma}$, $I_C = -5 \text{ a}$, See Note 4	-0.7		-0.7		
	$I_B = -1 \text{ a}$, $I_C = -10 \text{ a}$, See Note 4	-1.0		-1.0		
	$I_B = -1.5 \text{ a}$, $I_C = -15 \text{ a}$, See Note 4	-1.5		-1.5		
$V_{CE(sat)}$ Collector-Emitter Saturation Voltage	$I_B = -100 \text{ ma}$, $I_C = -1 \text{ a}$, See Note 4	-0.2		-0.2		v
	$I_B = -500 \text{ ma}$, $I_C = -5 \text{ a}$, See Note 4	-0.4		-0.4		
	$I_B = -1 \text{ a}$, $I_C = -10 \text{ a}$, See Note 4	-0.7		-0.7		
	$I_B = -1.5 \text{ a}$, $I_C = -15 \text{ a}$, See Note 4	-1.0*		-1.0*		
$ h_{fo} $ Small-Signal Common-Emitter Forward Current Transfer Ratio	$V_{CE} = -15 \text{ v}$, $I_C = -0.5 \text{ a}$, $f = 10 \text{ mc}$	1.0*		1.0*		
		2.0†		2.0†		

NOTE 4: If these parameters are measured without a heat sink, d-c collector current must not be applied longer than 250 msec.

*Indicates JEDEC registered data.

†Texas Instruments guarantees these values in addition to the JEDEC registered values which are also shown.

TYPES 2N1907, 2N1908 P-N-P ALLOY-DIFFUSED GERMANIUM POWER TRANSISTORS

switching characteristics at 25°C case temperature

PARAMETER	TEST CONDITIONS †	TYPICAL	UNIT
t_d Delay Time	$I_C = -10a, I_{B(1)} = -1.33a, I_{B(2)} = 1.33a,$ $V_{BE(ON)} = 2\text{ v}, R_L = 2\ \Omega,$ See Figure 1	0.1	μSEC
t_r Rise Time		0.8	μSEC
t_s Storage Time		2.5	μSEC
t_f Fall Time		1.0	μSEC
t_T Total Switching Time		4.4	μSEC

† Voltage and current values are nominal; exact values vary slightly with device parameters.

PARAMETER MEASUREMENT INFORMATION

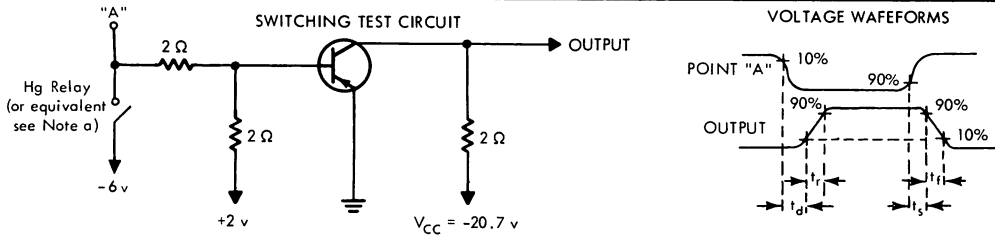

FIGURE 1

- NOTES: a. The pulse at point "A" has the following characteristics: $t_r \leq 20\text{ nsec}$, $t_f \leq 20\text{ nsec}$, $PW \geq 50\ \mu\text{sec}$, duty cycle $\leq 5\%$.
 b. The waveforms are monitored on an oscilloscope with the following characteristics: $t_r \leq 15\text{ nsec}$, $R_{in} \geq 1\text{ M}\Omega$, $C_{in} \leq 20\text{ pf}$.

TYPICAL CHARACTERISTICS

COMMON-EMITTER COLLECTOR CHARACTERISTICS
(Low-Voltage Region)

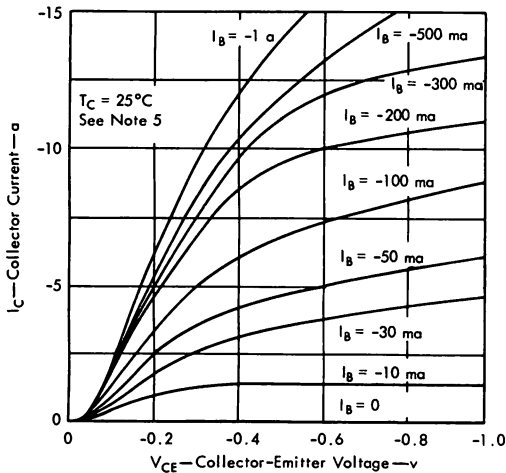

FIGURE 2

COMMON-EMITTER COLLECTOR CHARACTERISTICS
(High-Voltage Region)

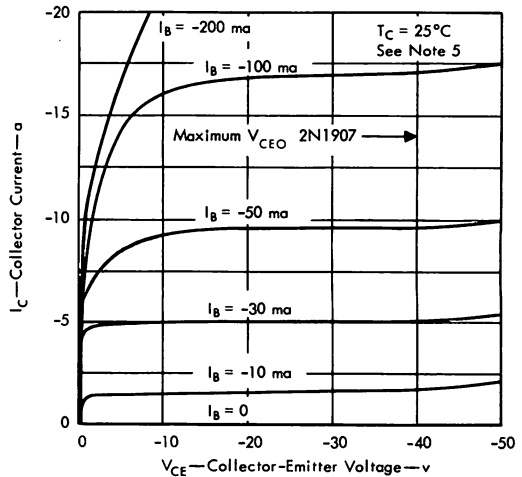

FIGURE 3

NOTE 5: These characteristics were measured using pulse techniques. $PW = 300\ \mu\text{sec}$, Duty Cycle $\leq 2\%$.

TYPES 2N1907, 2N1908

P-N-P ALLOY-DIFFUSED GERMANIUM POWER TRANSISTORS

TYPICAL CHARACTERISTICS

STATIC FORWARD CURRENT TRANSFER RATIO
vs
COLLECTOR CURRENT

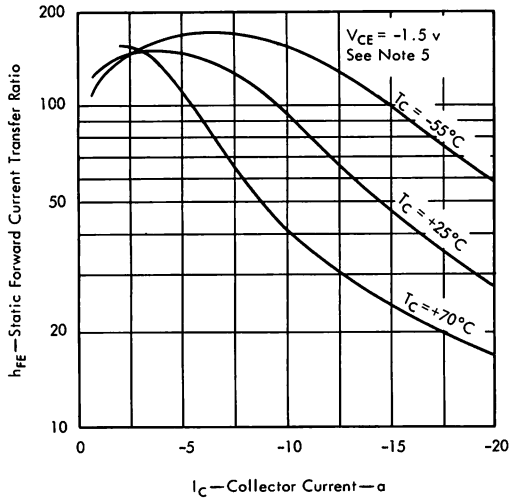

FIGURE 4

BASE-EMITTER VOLTAGE
vs
COLLECTOR CURRENT

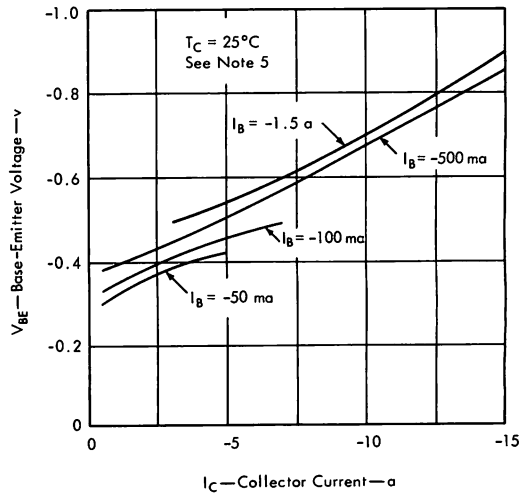

FIGURE 5

BASE-EMITTER VOLTAGE
vs
CASE TEMPERATURE

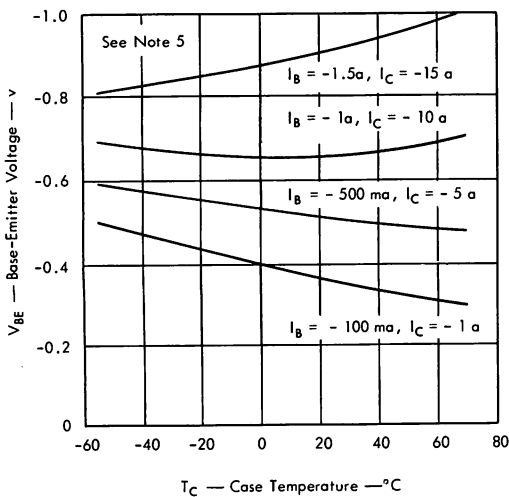

FIGURE 6

COLLECTOR-EMITTER SATURATION VOLTAGE
vs
CASE TEMPERATURE

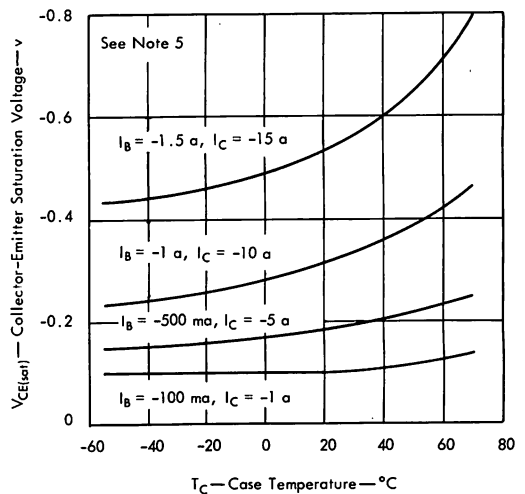

FIGURE 7

NOTE 5: These characteristics were measured using pulse techniques. PW = 300 μsec ., Duty Cycle $\leq 2\%$.

TYPES 2N1907, 2N1908 P-N-P ALLOY-DIFFUSED GERMANIUM POWER TRANSISTORS

TYPICAL CHARACTERISTICS

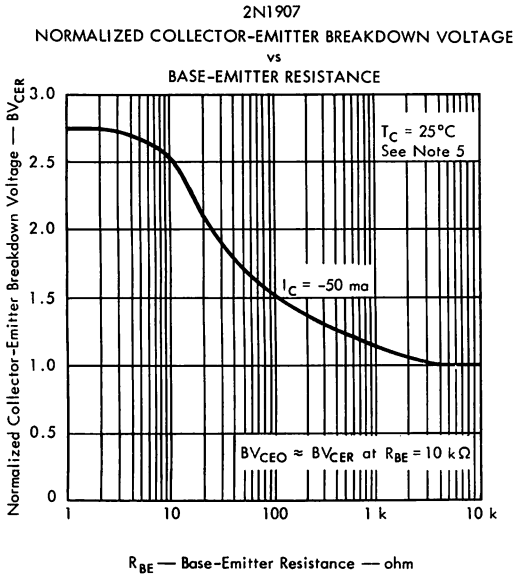

FIGURE 8

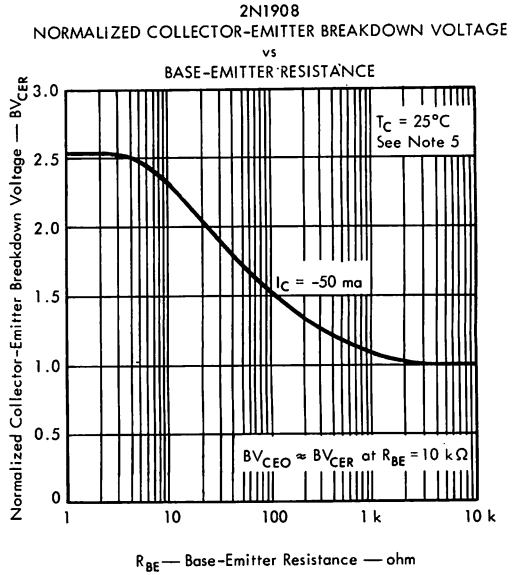

FIGURE 9

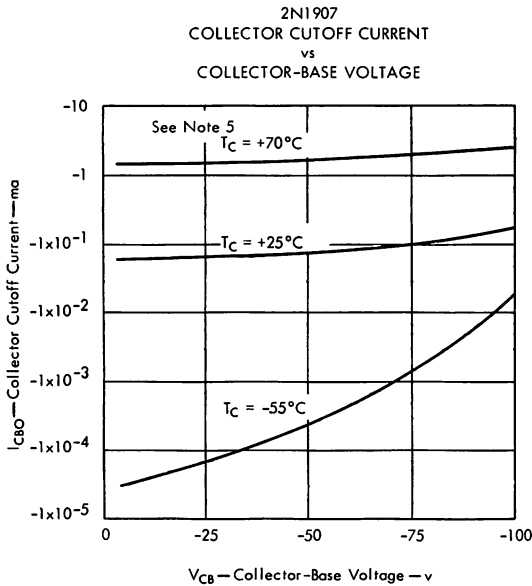

FIGURE 10

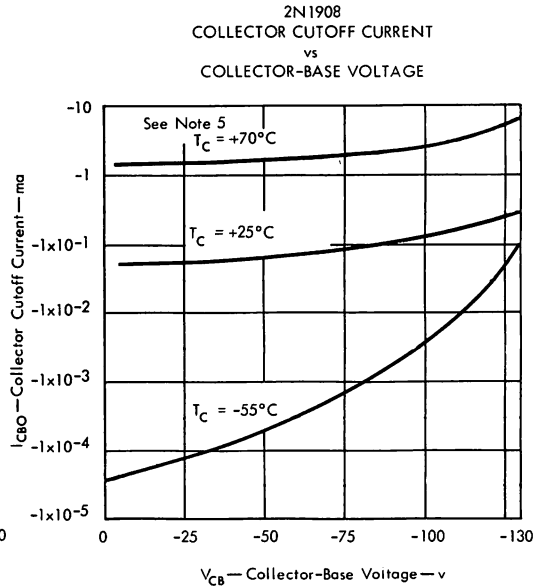

FIGURE 11

NOTE 5: These characteristics were measured using pulse techniques. $PW = 300 \mu\text{sec.}$, Duty Cycle $\leq 2\%$.

TYPES 2N1907, 2N1908

P-N-P ALLOY-DIFFUSED GERMANIUM POWER TRANSISTORS

THERMAL INFORMATION

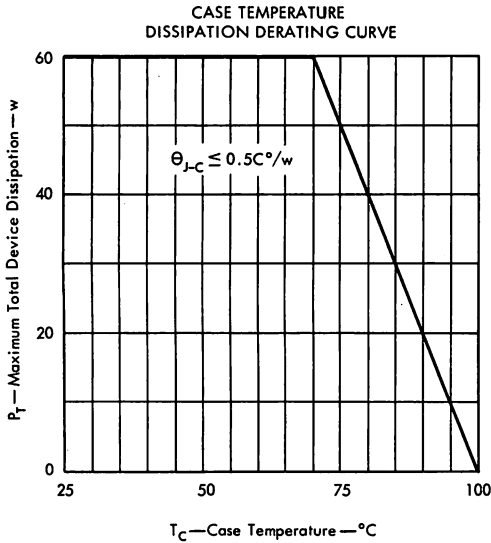

FIGURE 12

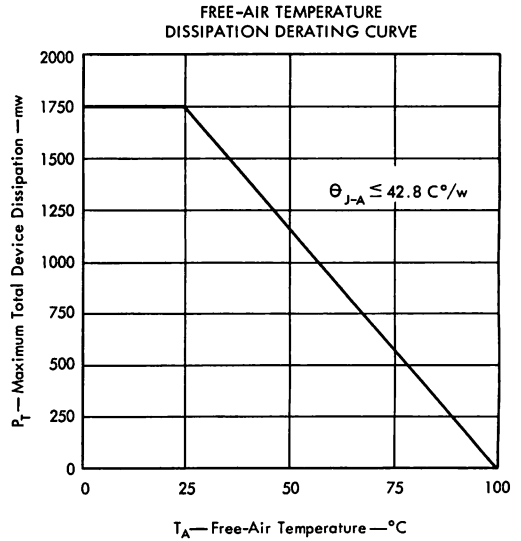

FIGURE 13

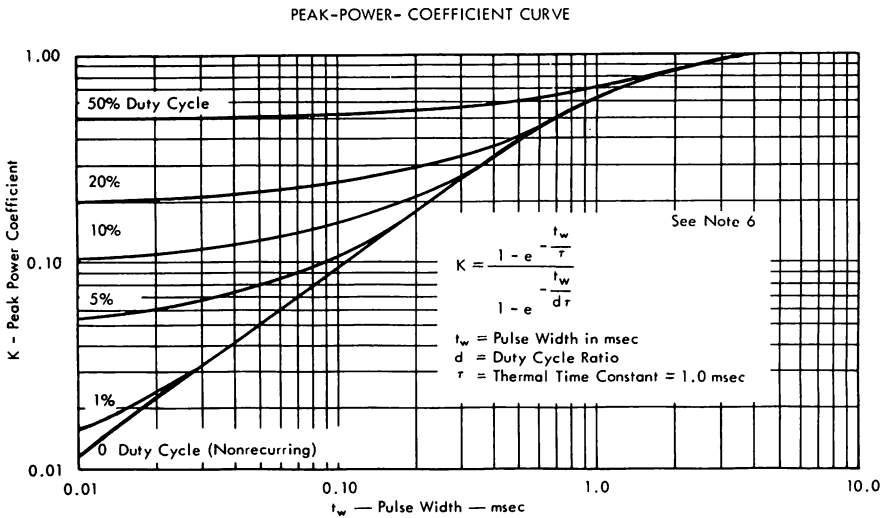

FIGURE 14

NOTE 6: When $t_w > 3.0$ msec or $d > 0.5$ (50%), operation must be confined to the continuous operating regions of Figure 15 or 16.

TYPES 2N1907, 2N1908 P-N-P ALLOY-DIFFUSED GERMANIUM POWER TRANSISTORS

MAXIMUM SAFE OPERATING REGIONS

2N1907
MAXIMUM SAFE CONTINUOUS
OPERATING REGION

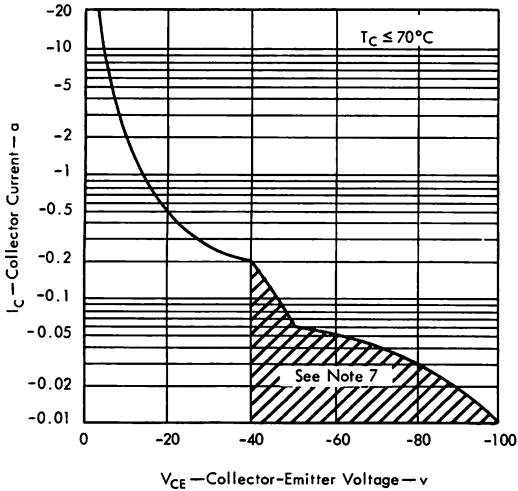

FIGURE 15

2N1908
MAXIMUM SAFE CONTINUOUS
OPERATING REGION

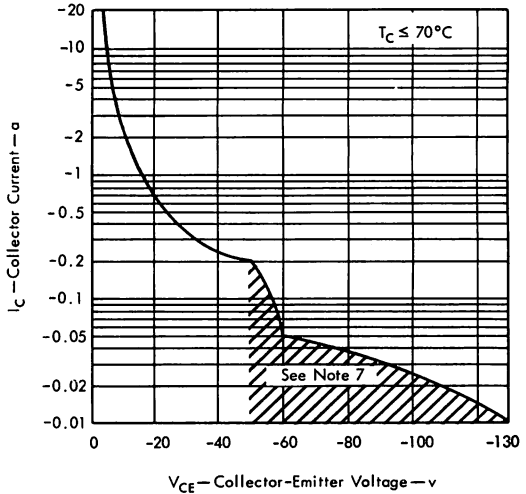

FIGURE 16

MAXIMUM SAFE PULSE OPERATING REGION

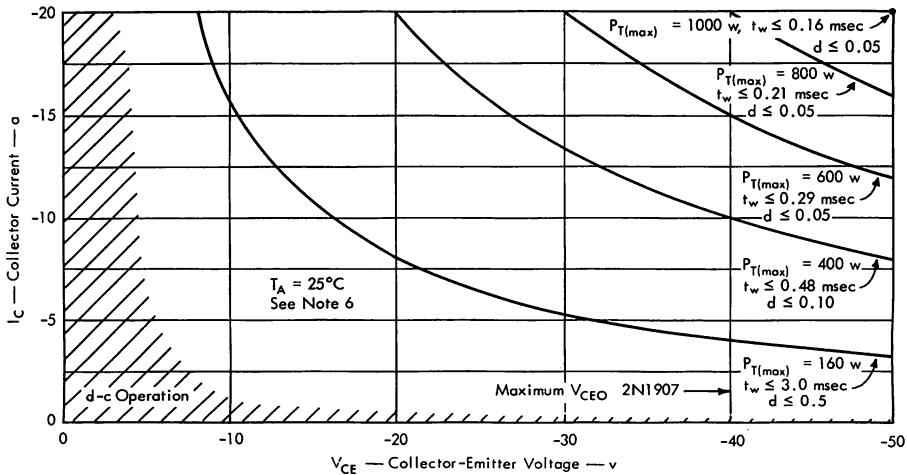

FIGURE 17

NOTES: 6. When $t_w > 3.0$ msec or $d > 0.5$ (50%), operation must be confined to the continuous operating regions of Figure 15 or 16.

7. Operation in this region is permissible when base-emitter resistance $R_{BE} \leq 5 \Omega$.

TYPES 2N1907, 2N1908

P-N-P ALLOY-DIFFUSED GERMANIUM POWER TRANSISTORS

THERMAL INFORMATION

TABLE I

HEAT SINK		$\dagger\theta_{HS-A}$
Type	Dimensions	
Bright Copper	4" x 4" x 1/8"	3.8 C°/w
	6" x 6" x 1/8"	2.2 C°/w
	8" x 8" x 1/8"	1.8 C°/w
	10" x 10" x 1/8"	1.4 C°/w
Bright Aluminum	4" x 4" x 1/8"	6.5 C°/w
	6" x 6" x 1/8"	4.5 C°/w
	8" x 8" x 1/8"	3.5 C°/w
	10" x 10" x 1/8"	2.8 C°/w
Delbert Blinn #113 or Modine 1E1155B, Unfinished (or Equivalents)		3.7 C°/w
Delbert Blinn #113 or Modine 1E1155B, Black Anodized (or Equivalents)		3.2 C°/w

$\dagger\theta_{HS-A}$ are typical values based on convection cooling; plates and fins mounted in vertical position.

‡All transistors mounted in the center of the heat sink with two 6-32 screws at 6 inch - pounds of torque.

TABLE II

SYMBOL	DEFINITION	UNIT	VALUE
P_T (avg)	Average Power Dissipation	w	
P_T (max)	Peak Power Dissipation	w	
θ_{J-C}	Junction-to-Case Thermal Resistance	C°/w	0.5
θ_{J-A}	Junction-to-Free-Air Thermal Resistance	C°/w	42.8
θ_{C-A}	Case-to-Free-Air Thermal Resistance	C°/w	42.3
$\ddagger\theta_{C-HS}$	Case-to-Heat-Sink Thermal Resistance Typical With Dry Mounting Base	C°/w	0.65
	Typical with DC-11 Silicone Grease		0.45
θ_{HS-A}	Heat-Sink-to-Free-Air Thermal Resistance	C°/w	⁵⁰⁰ Table 1
T_A	Free-Air Temperature	C°	
T_J (avg)	Average Junction Temperature	C°	≤ 100
T_J (max)	Peak Junction Temperature	C°	≤ 100
T_C	Case Temperature	C°	
K	Peak-Power Coefficient		⁵⁰⁰ Fig. 14
t_w	Pulse Width	msec	
t_p	Pulse Period	msec	
d	Duty Cycle Ratio (t_w/t_p)		

For d-c operation, these transistors are voltage limited as well as thermally limited. Figure 12 and Figure 15 or 16 are recommended as a guide for selecting safe voltage and current combinations.

These transistors have a very low thermal resistance that may be fully utilized in a pulse-power application provided the pulse width is equal to (or less than) 3 milliseconds. If the power pulse is longer than 3 milliseconds, then the operating path is limited to the safe operating region described by Figure 12 and Figure 15 or 16.

The PEAK-POWER-COEFFICIENT CURVE shows the ratio of maximum instantaneous junction-to-case temperature rise for any pulse width and duty cycle to the rise which occurs at 100% duty cycle. Use of this curve is best explained by the equations and example below. See Table II for a definition of terms.

Equation No. 1 — Application: d-c power dissipation, heat sink used.

$$P_T \text{ (avg)} = \frac{T_J \text{ (avg)} - T_A}{\theta_{J-C} + \theta_{C-HS} + \theta_{HS-A}}$$

Equation No. 2 — Application: d-c power dissipation, no heat sink used.

$$P_T \text{ (avg)} = \frac{T_J \text{ (avg)} - T_A}{\theta_{J-A}}$$

Equation No. 3 — Application: Peak power dissipation, heat sink used.

$$P_T \text{ (max)} = \frac{T_J \text{ (max)} - T_A}{d(\theta_{C-HS} + \theta_{HS-A}) + K\theta_{J-C}}$$

Equation No. 4 — Application: Peak power dissipation, no heat sink used.

$$P_T \text{ (max)} = \frac{T_J \text{ (max)} - T_A}{d\theta_{C-A} + K\theta_{J-C}}$$

Example — Find P_T (max) (design limit)

OPERATING CONDITIONS:

Heat Sink = 8" x 8" x 1/8" copper,

$\theta_{HS-A} = 1.8$ C°/w

with DC-11 grease, $\theta_{C-HS} = 0.45$ C°/w

T_J (max) (design limit) = 100°C

$T_A = 35$ °C

d = 20% (0.2)

$t_w = 0.1$ msec

SOLUTION:

From Figure 14 Peak-Power Coefficient,

K = 0.24, and by use of equation No. 3

$$P_T \text{ (max)} = \frac{T_J \text{ (max)} - T_A}{d(\theta_{C-HS} + \theta_{HS-A}) + K\theta_{J-C}}$$

$$P_T \text{ (max)} = \frac{100 - 35}{0.2(0.45 + 1.8) + 0.24(0.5)} = 114 \text{ w}$$

TYPES TI3027, TI3028 P-N-P ALLOY-JUNCTION GERMANIUM POWER TRANSISTORS



HIGH-POWER TRANSISTORS for CONSUMER APPLICATIONS

TYPES TI3027, TI3028
BULLETIN NO. DL-5 645053, APRIL 1964

mechanical data

These transistors are in a resistance-welded, hermetically sealed enclosure. The mounting base provides an excellent heat path from the collector junction to a heat sink. The entire mounting base must be in intimate contact with the heat sink for maximum heat transfer. A minimum torque of 10 inch-pounds applied to each of the mounting screws is recommended for mounting the device to the heat sink. Extreme cleanliness and the absence of flux during the assembly process prevents sealed-in contamination.

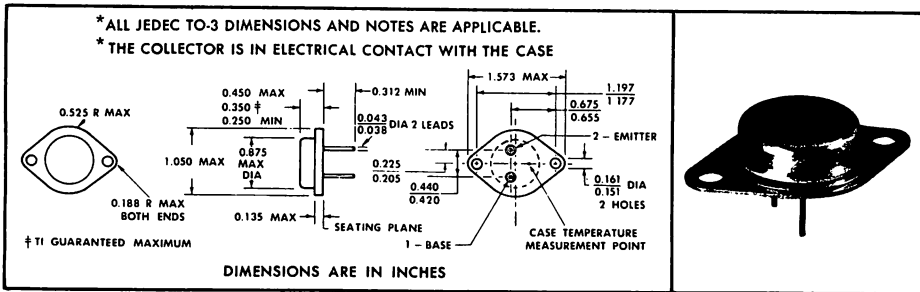

absolute maximum ratings at 25°C case temperature (unless otherwise noted)

	TI3027	TI3028
Collector-Base Voltage	-45 v	-60 v
Collector-Emitter Voltage (See Note 1)	-40 v	-50 v
Emitter-Base Voltage	← -20 v →	← -7 a →
Collector Current	← -3 a →	← 150 w →
Base Current	← -3 a →	← 2.0 w →
Total Device Dissipation at (or below) 25°C Case Temperature (See Note 2)	← -65°C to +100°C	← -65°C to +100°C
Total Device Dissipation at (or below) 25°C Free-Air Temperature (See Note 3)	← -65°C to +100°C	← 230°C →
Operating Case Temperature Range	← -65°C to +100°C	
Storage Temperature Range	← -65°C to +100°C	
Lead Temperature, 1/8 Inch from Case for 10 Seconds	← -65°C to +100°C	

- NOTES: 1. These values apply when the base-emitter resistance $R_{BE} \leq 68 \Omega$.
2. Derate linearly to 100°C case temperature at the rate of 2 w/C°.
3. Derate linearly to 100°C free-air temperature at the rate of 26.7 mw/C°.



TEXAS INSTRUMENTS
INCORPORATED
POST OFFICE BOX 5012 • DALLAS, TEXAS 75222

17301

TYPES T13027, T13028

P-N-P ALLOY-JUNCTION GERMANIUM POWER TRANSISTORS

electrical characteristics at 25°C case temperature (unless otherwise noted)

PARAMETER	TEST CONDITIONS	T13027		T13028		UNIT
		MIN	MAX	MIN	MAX	
BV_{CBO} Collector-Base Breakdown Voltage	$I_C = -5 \text{ ma}$, $I_E = 0$	-45		-60		v
BV_{CER} Collector-Emitter Breakdown Voltage	$I_C = -600 \text{ ma}$, $R_{BE} = 68 \Omega$, See Note 4	-40		-50		v
I_{CBO} Collector Cutoff Current	$V_{CB} = -2 \text{ v}$, $I_E = 0$		-0.15		-0.15	ma
	$V_{CB} = -30 \text{ v}$, $I_E = 0$		-1			
	$V_{CB} = -40 \text{ v}$, $I_E = 0$				-1	
I_{EBO} Emitter Cutoff Current	$V_{EB} = -20 \text{ v}$, $I_C = 0$		-1		-1	ma
h_{FE} Static Forward Current Transfer Ratio	$V_{CE} = -2 \text{ v}$, $I_C = -1 \text{ a}$, See Note 4	70		70		
	$V_{CE} = -2 \text{ v}$, $I_C = -3 \text{ a}$, See Note 4	40	250	40	250	
V_{BE} Base-Emitter Voltage	$V_{CE} = -2 \text{ v}$, $I_C = -1 \text{ a}$, See Note 4		-0.5		-0.5	v
	$V_{CE} = -2 \text{ v}$, $I_C = -3 \text{ a}$, See Note 4		-1.0		-1.0	
$V_{CE(sat)}$ Collector-Emitter Saturation Voltage	$I_B = -100 \text{ ma}$, $I_C = -1 \text{ a}$, See Note 4		-0.4		-0.4	v
	$I_B = -300 \text{ ma}$, $I_C = -3 \text{ a}$, See Note 4		-0.5		-0.5	
$ h_{fe} $ Small-Signal Common-Emitter Forward Current Transfer Ratio	$V_{CE} = -2 \text{ v}$, $I_C = -1 \text{ a}$, $f = 100 \text{ kc}$	2		2		

NOTE 4: These parameters must be measured using pulse techniques. $PW = 300 \mu\text{sec}$, Duty Cycle $\leq 2\%$.

thermal characteristics

PARAMETER	TEST CONDITIONS	MAX	UNIT
θ_{J-C} Junction-to-Case Thermal Resistance	See notes in Thermal Characteristics section	0.5	$^{\circ}\text{C}/\text{w}$
θ_{J-HS} Junction-to-Heat-Sink Thermal Resistance		1.1	$^{\circ}\text{C}/\text{w}$
θ_{J-A} Junction-to-Free-Air Thermal Resistance		37.5	$^{\circ}\text{C}/\text{w}$

NUMERICAL SYSTEM FOR h_{FE} CODING

Upon request the transistors will be numerically coded to identify matched pairs. The transistors are in-house classified into 2-db (ratio 1.26 to 1) h_{FE} brackets and any two units within a bracket constitute a matched pair. A 10% tolerance is included in the bracket limits shown below to allow for test-set correlation.

No h_{FE} -bracket distribution is implied by this classification system.

BRACKET NUMBER	h_{FE} RANGE at $V_{CE} = -2 \text{ v}$, $I_C = -3 \text{ a}$
1	40 — 60
2	50 — 80
3	65 — 100
4	80 — 125
5	100 — 150
6	125 — 200
7	160 — 250

TYPES T13027, T13028 P-N-P ALLOY-JUNCTION GERMANIUM POWER TRANSISTORS

THERMAL INFORMATION

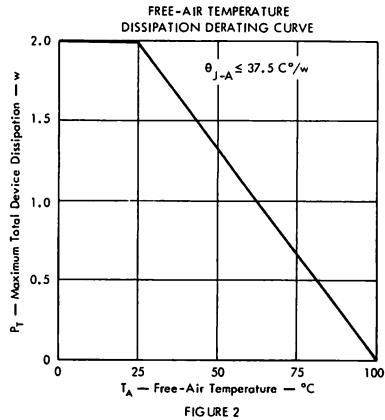
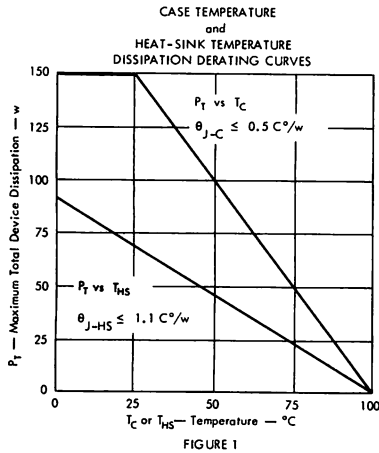

θ_{J-A} is the thermal resistance from the junction of the transistor to free-air. The curve shown above was determined by positioning the transistor in the center of a box 12 inches by 12 inches by 12 inches with the temperature measured two inches below the transistor.

θ_{J-C} is the thermal resistance from the junction of the transistor to the point on the mounting base of the transistor case specified on the outline drawing.

θ_{C-HS} is the thermal resistance from the mounting base of the transistor case to the mounting surface of the heat sink. The heat sink used to determine this value was a smooth, flat, copper plate, with the thermocouple mounted 0.05 inches below the mounting surface in an area beneath the center of the transistor. The transistor was mounted directly to a clean, dry, heat-sink surface, without the use of silicone grease, and a torque of ten inch-pounds was applied to each of the mounting screws.

θ_{J-HS} is the thermal resistance from the junction of the transistor to the mounting surface of the heat sink.
 $\theta_{J-HS} = \theta_{J-C} + \theta_{C-HS}$

The dissipation levels shown above are verified statistically by operating-life tests.

TYPICAL CHARACTERISTICS

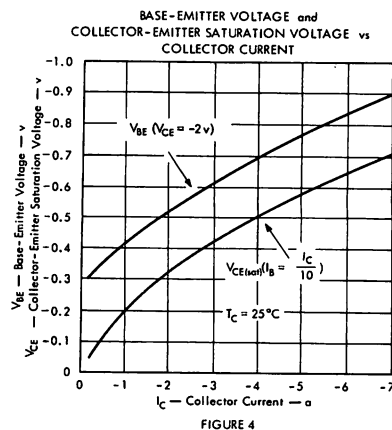
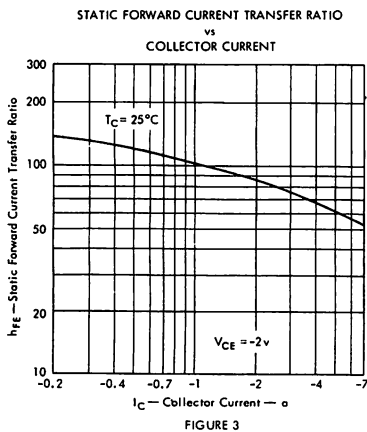

TYPES TI3027, TI3028 P-N-P ALLOY-JUNCTION GERMANIUM POWER TRANSISTORS

TYPICAL APPLICATION DATA

CLASS B AUDIO AMPLIFIER

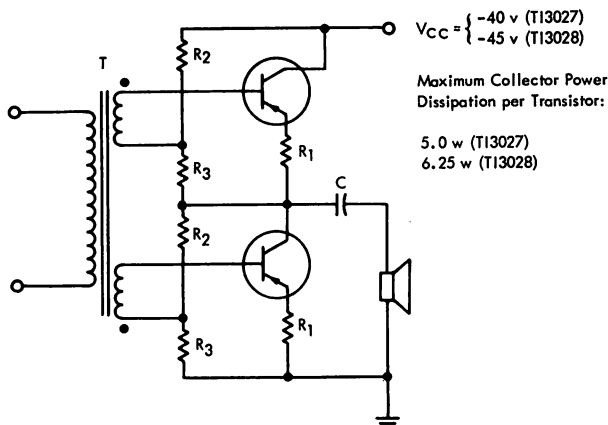

TYPICAL CIRCUIT PERFORMANCE CHARACTERISTICS

$T_A = 25^\circ\text{C}$, $f = 1000 \text{ cps}$ (except where noted)

	TI3027	TI3028
Minimum RMS Power Output at 5% Total Harmonic Distortion	20 w	25 w
Minimum Power Gain	18 db	20 db
Frequency Response	20 to 20,000 cps	
D-C Collector Current with Zero Signal	-0.05 a	-0.05 a
D-C Collector Current with Maximum Signal	-1.25 a	-1.10 a
Peak Collector Current with Maximum Signal	-3.9 a	-3.5 a
Input Impedance, Base-to-Base	73 Ω	68 Ω

CIRCUIT COMPONENT INFORMATION

	TI3027	TI3028
R_1 :	0.56 Ω , 1 w	0.56 Ω , 1 w
R_2 :	125 Ω , 5 w	150 Ω , 5 w
R_3 :	1.1 Ω , 1/2 w	1.2 Ω , 1/2 w

Speaker Impedance: 8 Ω 8 Ω

All resistors $\pm 10\%$ tolerance

C: Selected to meet desired low-frequency response. Working voltage equals 40 v.

T: Driver transformer primary-winding impedance, current-carrying capacity, and d-c resistance are determined by large-signal characteristics of driver stage. Secondary windings are bifilar wound. The a-c impedance of each secondary winding equals 18 ohms for TI3027 and 17 ohms for TI3028.

$V_{RM(wkg)}$. . . 25 to 175 Volts

- Rugged Whiskerless Construction
- Small Size
- Low Reverse Current

mechanical data

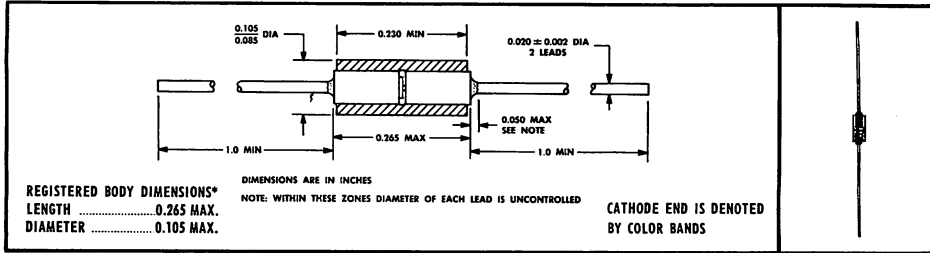

***absolute maximum ratings at 25°C free-air temperature (unless otherwise noted)**

	1N456	1N457	1N458	1N459	UNIT
V_{RM} Peak Reverse Voltage	30	70	150	200	V
$V_{RM(wkg)}$ Working Peak Reverse Voltage	25	60	125	175	V
I_O Average Rectified Forward Current at (or below) 25°C Free-Air Temperature (See Notes 1 and 2)	90	75	55	40	mA
I_F Steady State Forward Current at (or below) 25°C Free-Air Temperature (See Note 2)	135	110	80	60	mA
$I_{FM(surge)}$ Peak Surge Current, One Second (See Note 3)	0.7	0.6	0.5	0.4	A
$I_{FM(surge)}$ Peak Surge Current, Two Microseconds (See Note 4)	1.2	1	0.8	0.7	A
P Continuous Power Dissipation at (or below) 25°C Free-Air Temperature (See Note 5)	200				mW
T_{stg} Storage Temperature Range	-80 to 200				°C
Altitude	Any				

***electrical characteristics at 25°C free-air temperature (unless otherwise noted)**

PARAMETER	TEST CONDITIONS	1N456		1N457		1N458		1N459		UNIT
		MIN	MAX	MIN	MAX	MIN	MAX	MIN	MAX	
$V_{(BR)}$ Reverse Breakdown Voltage	$I_R = 100 \mu A$	30		70		150		200		V
I_R Static Reverse Current	$V_R = \text{Rated } V_{RM(wkg)}$	25		25		25		25		nA
	$V_R = \text{Rated } V_{RM(wkg)}$, $T_A = 150^\circ C$	5		5		5		5		μA
V_F Static Forward Voltage	$I_F = 40 \text{ mA}$	1								V
	$I_F = 20 \text{ mA}$			1						V
	$I_F = 7 \text{ mA}$					1				V
	$I_F = 3 \text{ mA}$							1		V

- NOTES: 1. These values may be applied continuously under single-phase 60-c/s half-sine-wave operation with resistive load.
 2. Derate linearly to 0 at 200°C free-air temperature.
 3. These values apply for a one-second square-wave pulse with the device at nonoperating thermal equilibrium immediately prior to the surge.
 4. These values apply for 2- μs pulses, duty cycle $\leq 1\%$, with the device at nonoperating thermal equilibrium immediately prior to the surge.
 5. Derate linearly to 200°C free-air temperature at the rate of 1.14 mW/deg.

†Trademark of Texas Instruments
 *Indicates JEDEC registered data

TI World-Wide Sales Offices

ALABAMA

Sahara Office Park Bldg., Suite 111
3313 Memorial Parkway, S.W.
Huntsville, Alabama 35801
205-881-4061

ARIZONA

2535 W. Camelback Rd., Suite 1D
Phoenix, Arizona 85017
602-279-5531

CALIFORNIA

1800 North Argyle Ave.
Hollywood, California 90028
213-466-7251

5005 West Century Blvd., Suite 208
Inglewood, California 90301
213-673-3943

230 California Ave., Suite 201
Palo Alto, California 94306
415-326-6770

1505 East 17th St., Suite 201
Santa Ana, California 92701
714-547-6506

4185 Adams Ave.
San Diego, California 92116
714-284-1181

COLORADO

2186 South Holly St., Suite 204
Denver, Colorado 80222
303-757-8548

CONNECTICUT

300 Amity Road
Woodbridge, Connecticut 06525
203-389-4521

FLORIDA

618 East South St., Suite 114
Orlando, Florida 32801
305-422-9894

ILLINOIS

Suite 205, Executive Towers
5901 N. Cicero Ave.
Chicago, Illinois 60646
312-286-1000

MASSACHUSETTS

60 Hickory Drive
Waltham, Mass. 02154
617-891-8450

MICHIGAN

Suite 706 West, Northland Towers Bldg.
15565 Northland Dr.
Southfield, Michigan 48075
313-357-1703

MINNESOTA

7615 Metro Blvd.
Suite 202, U.C.L.I. Bldg.
Edina, Minn. 55424
612-941-4384

NEW JERSEY

U.S. Highway #22
P.O. Box 366
Union, New Jersey 07083
201-687-7200

NEW YORK

P. O. Box 87, 2209 E. Main
Endicott, New York 13760
607-785-9987

4 Nevada Drive
New Hyde Park, N. Y. 11040
516-488-9894

131 Fulton Ave., Apt. J-2
Poughkeepsie, New York 12603
914-471-6095

6563 Ridings Rd.
Syracuse, New York 13206
315-463-9291

OHIO

22035 Chagrin Blvd.
Cleveland, Ohio 44122
216-751-2600

Suite 205, Paul Welch Bldg.
3300 South Dixie Dr.
Dayton, Ohio 45439
513-298-7513

PENNSYLVANIA

Benjamin Fox Pavilion
Suite 424, Foxcroft Square
Jenkintown, Pa. 19046
215-885-3454

TEXAS

MS80 — P.O. Box 5012
Dallas, Texas 75222
214-238-4861

3609 Buffalo Speedway
Houston, Texas 77006
713-526-3268

WASHINGTON

5801 Sixth Ave. S.
Seattle, Washington 98108
206-762-4240

WASHINGTON, D.C.

1875 Connecticut Ave., N.W., Suite 913
Washington, D.C. 20009
202-234-9320

CANADA

Geophysical Service Incorporated
280 Centre Str. East
Richmond Hills
Ontario, Canada
925-1035

663 Orly Avenue
Dorval
Quebec, Canada
631-6010

EUROPE

Texas Instruments Limited
Manton Lane
Bedford, England

Texas Instruments France S. A.
Boite Postale 5
Villeneuve-Loubet (A.M.), France

11 rue de Madrid
Paris 8^e, France

Texas Instruments Holland N.V.
Semiconductor Division
Enschedeestraat 19
Hengelo (Ov), Holland

Texas Instruments Italia S.p.A.
Via Colautti 1
Milan, Italy

Texas Instruments Incorporated
118 Rue du Rhone
1204 Geneva, Switzerland

Texas Instruments Sweden A.B.
Timmermangatan 34, Box 17116
Stockholm 17, Sweden

Texas Instruments Deutschland GmbH
Hildesheimerstr. 19
3 Hannover, W. Germany

Texas Instruments Deutschland GmbH
Wolframstrasse 26
7 Stuttgart
West Germany

Texas Instruments Deutschland GmbH
Clemensstrasse 30
8 Munich 23
West Germany

Texas Instruments Deutschland GmbH
Kepserstrasse 33
805 Freising-Lerchenfeld
West Germany

Texas Instruments Deutschland GmbH
Koenigsbacherstrasse 22
6 Frankfurt, West Germany

MEXICO

Texas Instruments de Mexico S.A.
Poniente 116 #489
Col. Ind. Vallejo
Mexico 15, D.F.

ARGENTINA

Texas Instruments Argentina S.A.I.C.F.
(P. O. Box 2296 — Correo Central)
Ruta Panamericana Km. 13, 5
Don Torcuato
Buenos Aires, Argentina

BRAZIL

Texas Instrumentos Electronicos
do Brazil Ltda.
Rua Cesario Alvim 770
Caixa Postal 30.103
Sao Paulo 6, Brazil

AUSTRALIA

Texas Instruments Australia Ltd.
Box 63, Oldham Road
Elizabeth, South Australia

Texas Instruments Australia Ltd.
Room 5, Rural Bank Bldg.
Burwood, N.S.W., Australia

JAPAN

Texas Instruments Asia Limited
404 T.B.R. Building
No. 59, 2-chome, Nagata-cho
Chiyoda-ku, Tokyo, Japan



TYPES 1N482, 1N483, 1N484, 1N485 DIFFUSED SILICON GENERAL PURPOSE DIODES



TYPES 1N482, 1N483, 1N484, 1N485
 BULLETIN NO. DLS-689041, AUGUST 1966
 REVISED MAY 1968

$V_{RM}(wkg)$. . . 36 to 180 Volts
Rugged Whiskerless Construction • Small Size
Designed for
Magnetic Amplifiers • Modulators • Demodulators
Networks • Power Supplies

mechanical data

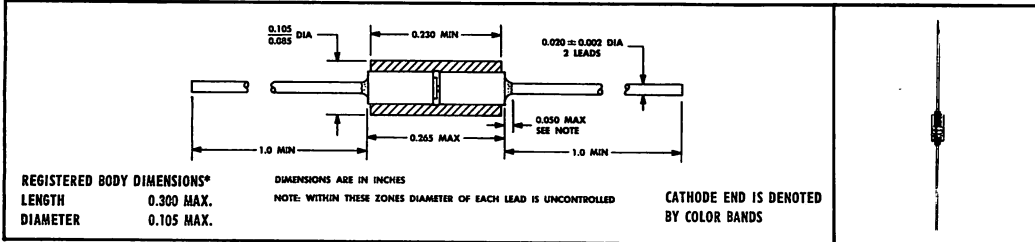

*absolute maximum ratings at 25°C free-air temperature (unless otherwise noted)

	1N482	1N483	1N484	1N485	UNIT
$V_{RM}(wkg)$ Working Peak Reverse Voltage	36	70	130	180	V
I_o Average Rectified Forward Current at (or below) 25°C Free-Air Temperature (See Notes 1 and 2)	100				mA
I_o Average Rectified Forward Current at 150°C Free-Air Temperature (See Notes 1 and 3)	25				mA
$I_{FM(rep)}$ Repetitive Peak Forward Current at (or below) 25°C Free-Air Temperature (See Note 4)	400				mA
$I_{FM(surge)}$ Peak Surge Current, 100 Milliseconds (See Note 5)	1				A
P Continuous Power Dissipation at (or below) 25°C Free-Air Temperature (See Note 6)	250				mW
$T_{A(opr)}$ Operating Free-Air Temperature Range	-65 to 200				°C
T_{stg} Storage Temperature Range	-65 to 200				°C

*electrical characteristics at 25°C free-air temperature (unless otherwise noted)

PARAMETER	TEST CONDITIONS	1N482	1N483	1N484	1N485	UNIT
		MIN MAX	MIN MAX	MIN MAX	MIN MAX	
V_{BR} Reverse Breakdown Voltage	$I_R = 100 \mu A$	40	80	150	200	V
I_R Static Reverse Current	1N482: $V_R = 30$ V 1N483: $V_R = 60$ V 1N484: $V_R = 125$ V 1N485: $V_R = 175$ V	0.25	0.25	0.25	0.25	μA
	$T_A = 25^\circ C$					
V_F Static Forward Voltage	$I_F = 100$ mA	1.1	1.1	1.1	1.1	V

- NOTES:
- These values may be applied continuously under single-phase 60-Hz half-sine-wave operation with resistive load.
 - Derate linearly to 25 mA at 150°C free-air temperature.
 - Derate linearly to 0 at 200°C free-air temperature.
 - These values apply for a 4-ms square-wave pulse, duty cycle $\leq 25\%$.
 - These values apply for a 1/10-second square-wave pulse with the device at nonoperating thermal equilibrium immediately prior to the surge.
 - Derate linearly to 200°C free-air temperature at the rate of 1.43 mW/deg.

†Trademark of Texas Instruments
 *Indicates JEDEC registered data



TEXAS INSTRUMENTS
 INCORPORATED
 POST OFFICE BOX 5012 • DALLAS, TEXAS 75222

18105

TI Microlibrary Books for Creative Circuit Designers

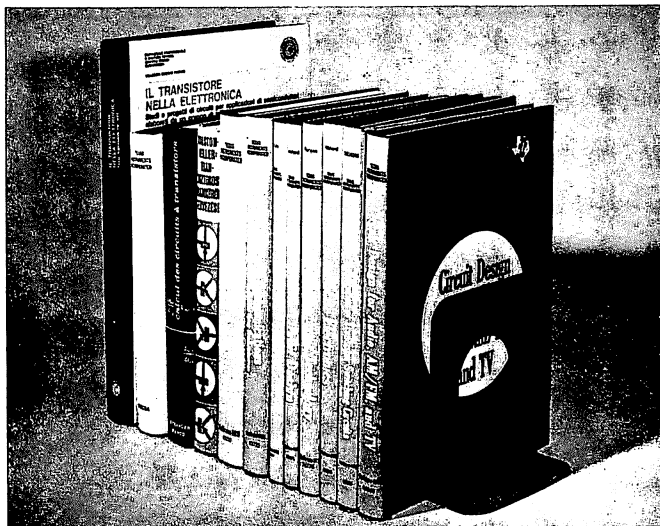

TRANSISTOR CIRCUIT DESIGN

523 Pages • 526 Illustrations • Published January '63 •
Shipping Weight 3-lb 4 oz • \$15.00

FIELD-EFFECT TRANSISTORS • L. J. SEVIN

138 Pages • 137 Illustrations • Published April '65 •
Shipping Weight 1-lb 10-oz • \$10.00

MOSFET IN CIRCUIT DESIGN • ROBERT H. CRAWFORD

136 Pages • 100 Illustrations • Published May '67 •
Shipping Weight 1-lb 10-oz • \$10.00

CIRCUIT DESIGN FOR AUDIO, AM/FM AND TV

352 Pages • 145 Illustrations • Published February '67 •
Shipping Weight 2-lb 8-oz • \$14.50

SILICON SEMICONDUCTOR TECHNOLOGY • W. R. RUNYAN

256 Pages • 301 Illustrations • Published May '65 •
Shipping Weight 2-lb 9-oz • \$16.50

DESIGN AND APPLICATION OF TRANSISTOR SWITCHING CIRCUITS • LOUIS DELHOM

278 Pages • 315 Illustrations • Published January '68 •
Shipping Weight 2-lb • \$14.50

SOLID STATE COMMUNICATIONS

366 Pages • 417 Illustrations • Published April '66 •
Shipping Weight 2-lb 9-oz • \$12.50

SOLID STATE ELECTRONICS • ROBERT G. HIBBERD

170 Pages • 90 Illustrations • Published January '68 •
Shipping Weight 1-lb 12-oz • \$8.95

Terms: F.O.B. destination, bulk rate.
Other than bulk rate,
indicate method of shipment,
add shipping charges.

Outside U.S.: Indicate method of shipment,
add shipping charges.

Send check or money order
(no purchase orders) to:

EXECUTIVE SERVICES DISTRIBUTION
Suite 148
8383 Stemmons Freeway
Dallas, Texas 75247



TYPES 1N645 THRU 1N649, 1N645A DIFFUSED SILICON GENERAL-PURPOSE DIODES



400 mA • 225 V to 600 V
Ruggedized to meet stringent military requirements

mechanical data

The diode is encased in a hermetically sealed hard-glass package. The outline drawing meets the JEDEC DO-7 outline.

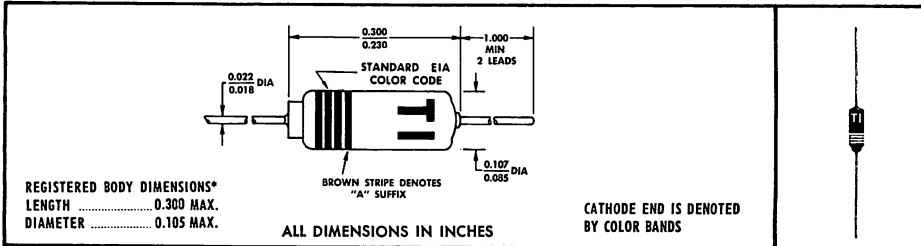

TYPES 1N645 THRU 1N649, 1N645A
BULLETIN NO. DL-5 669125, OCTOBER 1966
REPLACES BULLETIN NO. DL-5 1011, NOVEMBER 1958
AND BULLETIN NO. DL-5 1171, OCTOBER 1959

*absolute maximum ratings at 25°C free-air temperature (unless otherwise noted)

	1N645	1N645A	1N646	1N647	1N648	1N649	UNIT
$V_{RM(wkg)}$ Working Peak Reverse Voltage over Operating Free-Air Temperature Range	225	225	300	400	500	600	V
I_o Average Rectified Forward Current at (or below) 25°C Free-Air Temperature (See Note 1)	400						mA
I_o Average Rectified Forward Current at 150°C Free-Air Temperature (See Note 1)	150						mA
$I_{FM(surge)}$ Peak Surge Current, One Second, at 25°C to 150°C Free-Air Temperature (See Note 2)	3						A
P Continuous Power Dissipation at (or below) 25°C Free-Air Temperature (See Note 3)	600						mW
$T_{A(opr)}$ Operating Free-Air Temperature Range	-65 to 150						°C
Altitude at Rated Working Peak Reverse Voltage	100 000						ft

*electrical characteristics at 25°C free-air temperature (unless otherwise noted)

PARAMETER	TEST CONDITIONS	1N645	1N645A	1N646	1N647	1N648	1N649	UNIT
		MIN MAX	MIN MAX	MIN MAX	MIN MAX	MIN MAX	MIN MAX	
$V_{(BR)}$ Reverse Breakdown Voltage	$I_R = 100 \mu A$, $T_A = 100^\circ C$	275	275	360	480	600	720	V
I_R Static Reverse Current	$V_R = \text{Rated } V_{RM(wkg)}$	0.2	0.2	0.2	0.2	0.2	0.2	μA
	$V_R = \text{Rated } V_{RM(wkg)}$, $T_A = 100^\circ C$	15	15	15	20	20	25	μA
	$V_R = 60 V$		0.05					μA
	$V_R = 60 V$, $T_A = 125^\circ C$		10					μA
V_F Static Forward Voltage	$I_F = 400 mA$	1	1	1	1	1	1	V
C_T Total Capacitance	$V_R = 12 V$, $f = 1 MHz$	6 typ	6 typ	6 typ	6 typ	6 typ	6 typ	pF

NOTES: 1. These values may be applied continuously under single-phase 60-Hz half-sine-wave operation with resistive load. Above 25°C derate according to figure 3.
2. These values apply for a one-second square-wave pulse with the device at nonoperating thermal equilibrium immediately prior to the surge.
3. Derate linearly to 200 mW at 150°C free-air temperature at the rate of 3.2 mW/deg.

*Indicates JEDEC registered data.



TEXAS INSTRUMENTS
INCORPORATED
POST OFFICE BOX 5012 • DALLAS, TEXAS 75222

TYPES 1N645 THRU 1N649, 1N645A DIFFUSED SILICON GENERAL-PURPOSE DIODES

TYPICAL CHARACTERISTICS

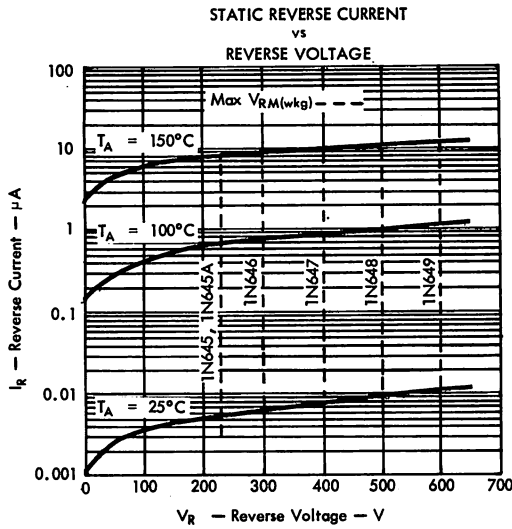

FIGURE 1

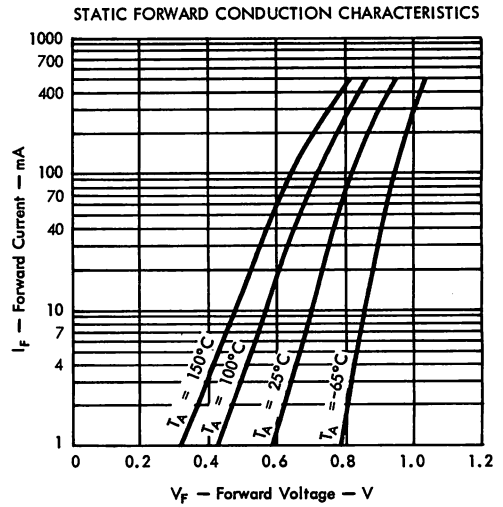

FIGURE 2

THERMAL CHARACTERISTICS

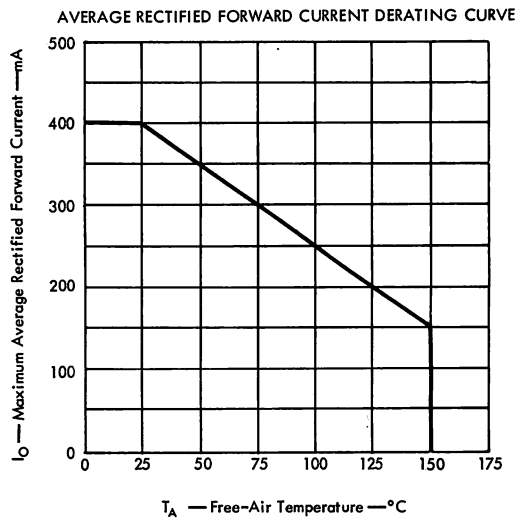

FIGURE 3



TYPES 1N914, 1N914A, 1N914B, 1N915, 1N916, 1N916A, 1N916B and 1N917 DIFFUSED SILICON SWITCHING DIODES



- Extremely Stable and Reliable High-Speed Diodes

TYPES 1N914, 1N914A, 1N914B, 1N915, 1N916, 1N916A, 1N916B, 1N917
BULLETIN NO. DI-5 683424, JANUARY 1963
REVISED MAY 1968

mechanical data

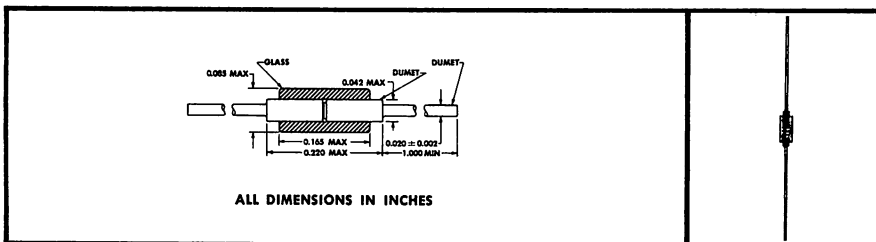

absolute maximum ratings at 25°C ambient temperature (unless otherwise noted)

- V_R Reverse Voltage at -65 to +150°C
 I_o Average Rectified Fwd. Current
 I_{o+} Average Rectified Fwd. Current at +150°C
 i_f Recurrent Peak Fwd. Current
 $i_{f(surge)}$ Surge Current, 1 sec
 P Power Dissipation
 T_A Operating Temperature Range
 T_{stg} Storage Temperature Range

1N914	1N914A	1N914B	1N915	1N916	1N916A	1N916B	1N917	Unit	
75	75	75	50	75	75	75	30	v	
75	75	75	75	75	75	75	50	ma	
10	10	10	10	10	10	10	10	ma	
225	225	225	225	225	225	225	150	ma	
500	500	500	500	500	500	500	300	ma	
250	250	250	250	250	250	250	250	mw	
								-65 to +175	°C
								200	°C

maximum electrical characteristics at 25°C ambient temperature (unless otherwise noted)

- BV_R Min Breakdown Voltage at 100 μ a
 I_R Reverse Current at V_R
 I_R Reverse Current at -20 v
 I_R Reverse Current at -20 v at 100°C
 I_R Reverse Current at -20 v at +150°C
 I_R Reverse Current at -10 v
 I_R Reverse Current at -10 v at 125°C
 I_F Min Fwd Current at $V_F = 1$ v
 V_F at 250 μ a
 V_F at 1.5 ma
 V_F at 3.5 ma
 V_F at 5 ma
 V_F Min at 5 ma
 C Capacitance at $V_R = 0$

100	100	100	65	100	100	100	40	v
5	5	5	5	5	5	5		μ a
0.025	0.025	0.025		0.025	0.025	0.025		μ a
3	3	3	5	3	3	3	25	μ a
50	50	50		50	50	50		μ a
			0.025				0.05	μ a
								μ a
10	20	100	50	10	20	30	10	ma
							0.64	v
							0.74	v
							0.83	v
		0.72	0.73			0.73		v
			0.60					v
4	4	4	4	2	2	2	2.5	pf

operating characteristics at 25°C ambient temperature (unless otherwise noted)

- t_{rr} Max Reverse Recovery Time
 V_f Fwd Recovery Voltage (50 ma Peak Sq. wave, 0.1 μ sec pulse width, 10 nsec rise time, 5 kc to 100 kc rep. rate)

**4 °8	**4 °8	**4 °8	°10	**4 °8	**4 °8	**4 °8	°3	nsec
								nsec
2.5	2.5	2.5	2.5	2.5	2.5	2.5	2.5	v

* Trademark of Texas Instruments
 ° Lumatron (10 ma I_F , 10 ma I_R , recover to 1 ma)
 ** E686 (10 ma I_F , 6v V_R , recover to 1 ma)



TEXAS INSTRUMENTS
 INCORPORATED
 POST OFFICE BOX 5012 • DALLAS, TEXAS 75222

19201

AUTHORIZED DISTRIBUTORS

FOR TEXAS INSTRUMENTS COMPONENTS GROUP

ALABAMA

ACK SEMICONDUCTORS INC.
3101 Fourth Ave. South/(205) FA 2-0588
Birmingham, Alabama 35233

ELECTRONIC WHOLESALERS, INC.
2310 Bob Wallace Avenue, S.W.
(205) 534-2461
Huntsville, Alabama 35805

ARIZONA

KIERULFF ELECTRONICS, INC.
2633 East Buckeye Road
(602) 273-7331
Phoenix, Arizona 85034

R. V. WEATHERFORD COMPANY
1917 North 25 Drive/(602) 272-7144
Carson Industrial Center
Phoenix, Arizona

CALIFORNIA

CALIFORNIA ELECTRONICS SUPPLY, INC.
1911 Armacost Avenue/(213) TR 9-0760
West Los Angeles, California 90025

KIERULFF ELECTRONICS, INC.
3969 E. Bayshore/(415) 968-6292
Palo Alto, California 94303

MILO OF CALIFORNIA
2060 India St./(714) BE 2-8951
San Diego, California 92101

RADIO PRODUCTS SALES, INC.
1501 S. Hill St./(213) RI 8-1271
Los Angeles, California 90015

R. V. WEATHERFORD COMPANY
1651 S. State College Blvd.
(714) KI 7-7521
Anaheim, California 92805

6921 San Fernando Rd./(213) VI 9-3451
Glendale, California 91201
3240 Hillview Drive
Stanford Industrial Park
(415) DA 1-5373
Palo Alto, California 94304

TI SUPPLY COMPANY
1651 Tenth Street/(213) 393-6731
Santa Monica, California 90404

COLORADO

TI SUPPLY COMPANY
2186 S. Holly/(303) 757-7671
Denver, Colorado 80222

FLORIDA

ELECTRONIC WHOLESALERS, INC.
345 Graham Ave./(305) 841-1550
Orlando, Florida 32814

9390 N. W. 27th Ave./(305) OX 6-1620
Miami, Florida 33147

ILLINOIS

ALLIED ELECTRONICS CORPORATION
100 N. Western Ave./(312) TA 9-9100
Chicago, Illinois 60680

MERQUIP ELECTRONICS, INC.
7701 No. Austin Ave./(312) 965-7500
Skokie, Illinois 60076

NEWARK ELECTRONICS CORP.
500 N. Pulaski Road/(312) 638-4411
Chicago, Illinois 60624

TI SUPPLY COMPANY
7135 N. Barry Avenue/(312) 296-7187
Des Plaines, Illinois 60018

INDIANA

ESCO ELECTRONICS INC.
2442 N. Shadeland Ave./(317) 357-8791
Indianapolis, Indiana 46219

RADIO DISTRIBUTING COMPANY
814 North Senate Avenue
(317) 637-5571
Indianapolis, Indiana 46204

IOWA

DEECO, INC.
618 First St., N. W./(319) EM 5-7551
Cedar Rapids, Iowa 52405

LOUISIANA

ELECTRONIC PRODUCTS CORPORATION
3622 Toulouse St./(504) HU 6-3777
New Orleans, Louisiana 70119

MARYLAND

ELECTRONIC WHOLESALERS, INC.
3200 Wilkens Ave./(301) 646-3600
Baltimore, Maryland 21223

MILGRAY/WASHINGTON
5405 Lafayette Place/(202) 864-1111
Hyattsville, Maryland 20781

MASSACHUSETTS

DEMAMBRO ELECTRONICS
1095 Commonwealth Ave.
(617) 787-1200
Boston, Massachusetts 02215

TI SUPPLY COMPANY
480 Neponset Road/(617) 828-5020
Canton, Massachusetts 02021

LAFAYETTE INDUSTRIAL ELECTRONICS
1400 Worcester Rd./(617) 969-6100
Natick, Massachusetts 01760

MILGRAY/NEW ENGLAND INC.
75 Terrace Hall Avenue/(617) 272-6800
Burlington, Massachusetts 02021

MICHIGAN

NEWARK-DETROIT ELECTRONICS, INC.
20700 Hubbell Ave./(313) 548-0250
Detroit, Michigan 48237

NEWARK-INDUSTRIAL
ELECTRONICS CORP.
2114 So. Division/(616) CH 1-5695
Grand Rapids, Michigan 49507

MINNESOTA

STARK ELECTRONIC SUPPLY CO.
112 Third Avenue N./(612) FE 2-1325
Minneapolis, Minnesota 55401

MISSOURI

TI SUPPLY COMPANY
2916 Holmes Street/(816) 753-4750
Kansas City, Missouri 64109

ELECTRONIC COMPONENTS FOR
INDUSTRY
2605 South Hanley Rd./(314) MI 7-5505
St. Louis, Missouri 63144

NEW JERSEY

GENERAL RADIO SUPPLY COMPANY, INC.
600 Penn St./(609) WO 4-8560
Camden, New Jersey 08102

TI SUPPLY COMPANY
301 Central Ave./(201) 382-6400
Clark, N. J. 07066

NEW MEXICO

KIERULFF ELECTRONICS, INC.
2524 Baylor Dr. S.E./(505) 247-1055
Albuquerque, New Mexico 87108

NEW YORK

GENESEE RADIO & PARTS CO., INC.
2550 Delaware Ave./(716) TR 3-9661
Buffalo, New York 14216

LAFAYETTE INDUSTRIAL ELECTRONICS
165-08 Liberty Ave./(212) 658-5050
Jamaica, New York 11431

MILGRAY/NEW YORK
160 Varick St./(212) YU 9-1600
New York, New York 10013

ROCHESTER RADIO SUPPLY CO., INC.
140 W. Main St./(716) 454-7800
Rochester, New York 14614

TI SUPPLY COMPANY
4 Nevada Dr./(516) 488-3300
New Hyde Park, L. I., N. Y. 11040

NORTH CAROLINA

ELECTRONIC WHOLESALERS, INC.
938 Burke St./(919) PA 5-8711
Winston-Salem, North Carolina 27101

OHIO

ESCO ELECTRONICS INC.
3130 Valleywood Drive/(513) 298-0191
Dayton, Ohio 45429

MILGRAY/CLEVELAND
1821 East 40th Street/(216) 881-8800
Cleveland, Ohio 44102

NEWARK-HERRLINGER
ELECTRONICS CORP.
112 E. Liberty St./(513) GA 1-5282
Cincinnati, Ohio 45210

W. M. PATTISON SUPPLY CO.
4550 Willow Parkway/(216) 441-3000
Cleveland, Ohio 44125

SREPCO ELECTRONICS, INC.
314 Leo Street/(513) BA 4-3871
Dayton, Ohio 45404

OKLAHOMA

TI SUPPLY COMPANY
12151 E. Skelly Dr./(918) 437-4555
Tulsa, Oklahoma 74110

OREGON

ALMAC STROUM ELECTRONICS
CORPORATION
8888 S.W. Canyon Road/(503) 292-3534
Portland, Oregon 97225

PENNSYLVANIA

MILGRAY/DELAWARE VALLEY INC.
2532 N. Broad St./(215) BA 8-2000
Philadelphia, Penn. 19107

RPC ELECTRONICS
620 Alpha Dr./(412) 782-3770
RIDC Park
Pittsburgh, Pennsylvania 15238

TEXAS

TI SUPPLY COMPANY
6000 Denton Drive/(214) FL 7-6121
Dallas, Texas 75235

5240 Elm Street/(713) MO 6-2175
Houston, Texas 77036

HARRISON EQUIPMENT COMPANY, INC.
1422 San Jacinto St./(713) CA 4-9131
Houston, Texas 77001

MIDLAND SPECIALTY COMPANY
2235 Wyoming Ave./(915) KE 3-9555
El Paso, Texas 79903

UTAH

STANDARD SUPPLY COMPANY
225 E. Sixth South St./(801) EL 5-2971
Salt Lake City, Utah 84110

WASHINGTON

ALMAC-STROUM ELECTRONICS
5811 Sixth Ave. So./(206) 763-2300
Seattle, Washington 98108

WASHINGTON, D.C.
ELECTRONIC WHOLESALERS, INC.
2345 Sherman Ave., N. W.
(202) HU 3-5200
Washington, D.C. 20001

CANADA

CANADIAN ELECTRONICS LTD.
Calgary, Alberta
Edmonton, Alberta
Lethbridge, Alberta
Medicine Hat, Alberta
Vancouver, B. C.

CESCO ELECTRONICS LTD.
Downsview, Quebec
Quebec, Quebec
Ottawa, Ontario
Toronto, Ontario

TI SUPPLY COMPANY
Dorval, Quebec

WELLINGTON, New Zealand
W. G. LEATHAM LTD.

AUSTRALIAN TI DISTRIBUTOR

MELBOURNE, Australia
RADIO PARTS PTY, LTD.

PERTH, Australia
PRECISION ELECTRONICS

BRISBANE, Australia
DOUGLAS ELECTRONICS

EUROPEAN TI DISTRIBUTORS

BRUSSELS IV, Belgium
S.A. AVI-ELEC N.V.

COPENHAGEN V, Denmark
TEXAS INSTRUMENTS A/S

HELSINKI, Finland
OY CHESTER AB

HAMBURG, West Germany
FIRMA ALFRED NEYE, ENATECHNIK

STUTTGART, WEST GERMANY
TI SUPPLY CO.

OSLO, Norway
MORGENSTIERNE & CO.

STOCKHOLM, Sweden
AB GOSTA BACKSTROM

ZURICH 32, Switzerland
FABRIMEX AG ZURICH

PARIS, FRANCE
TI SUPPLY CO.

MILANO, ITALY
TI SUPPLY CO.

MANCHESTER, ENGLAND
TI SUPPLY CO.



WHISKERLESS, DOUBLE-PLUG CONSTRUCTION

mechanical data

The glass-passivated silicon wafer is encased in a hermetically sealed glass package. The high-temperature bond between wafer and leads ensures integral positive contact under extreme environmental conditions.

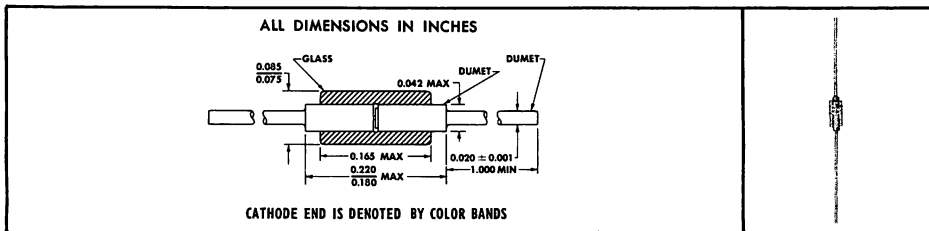

TYPE 1N3064
BULLETIN NO. DL-5 661914, SEPTEMBER 1966
REPLACES BULLETIN NO. DL-5 622683, MAY 1962

absolute maximum ratings at 25°C free-air temperature (unless otherwise noted)

*V _{RM}	Peak Reverse Voltage	75 V
I _F	Steady-State Forward Current at (or below) 25°C Free-Air Temperature (See Note 1).	115 mA
I _{FM(surge)}	Peak Surge Current, One Second (See Note 2)	500 mA
I _{FM(surge)}	Peak Surge Current, One Microsecond (See Note 2)	2 A
*P	Continuous Power Dissipation at (or below) 25°C Free-Air Temperature (See Note 3).	250 mW
*T _{stg}	Storage Temperature Range	-65°C to 200°C
*T _L	Lead Temperature 1/8 Inch from Case for 2 Seconds	250°C

*electrical characteristics at 25°C free-air temperature (unless otherwise noted)

PARAMETER	TEST CONDITIONS	MIN	MAX	UNIT
V _(BR)	Reverse Breakdown Voltage	I _R = 5 μA	75	V
I _R	Static Reverse Current	V _R = 50 V	0.1	μA
V _F	Static Forward Voltage	V _R = 50 V, T _A = 150°C	100	μA
α _{VF}	Temperature Coefficient of Static Forward Voltage	I _F = 10 mA	1	V
C _T	Total Capacitance	I _F = 10 mA, See Note 4	3	mV/deg
		V _R = 0, f = 1 MHz	2	pF

*operating characteristics at 25°C free-air temperature

PARAMETER	TEST CONDITIONS	MIN	MAX	UNIT
t _{rr}	Reverse Recovery Time	I _F = 10 mA, I _{RM} = 10 mA, R _L = 100 Ω, C _L = 10 pF, i _{rr} = 1 mA, See Figure 1	4	ns
V _{FM(roc)}	Forward Recovery Voltage	I _F = 100 mA, R _L = 50 Ω, See Figure 2	3	V
η _r	Rectification Efficiency	V _r = 2 V, R _L = 5 kΩ, C _L = 20 pF, Z _{source} = 50 Ω, f = 100 MHz	45 %	

- NOTES: 1. These values may be applied continuously under single-phase 60-Hz half-sine-wave operation with resistive load. Derate linearly to 0 at 150°C free-air temperature.
 2. These values apply for the specified square-wave pulse with the device at nonoperating thermal equilibrium immediately prior to the surge.
 3. Derate linearly at the rate of 1.5 mW/deg.
 4. Temperature coefficient, α_{VF}, is determined by the following formula:

$$\alpha_{VF} = \frac{V_F @ 150^\circ\text{C} - V_F @ -55^\circ\text{C}}{150^\circ\text{C} - (-55^\circ\text{C})}$$

†Trademark of Texas Instruments

*Indicates JEDEC registered data



TYPE 1N3064

DIFFUSED SILICON SWITCHING DIODE

PARAMETER MEASUREMENT INFORMATION

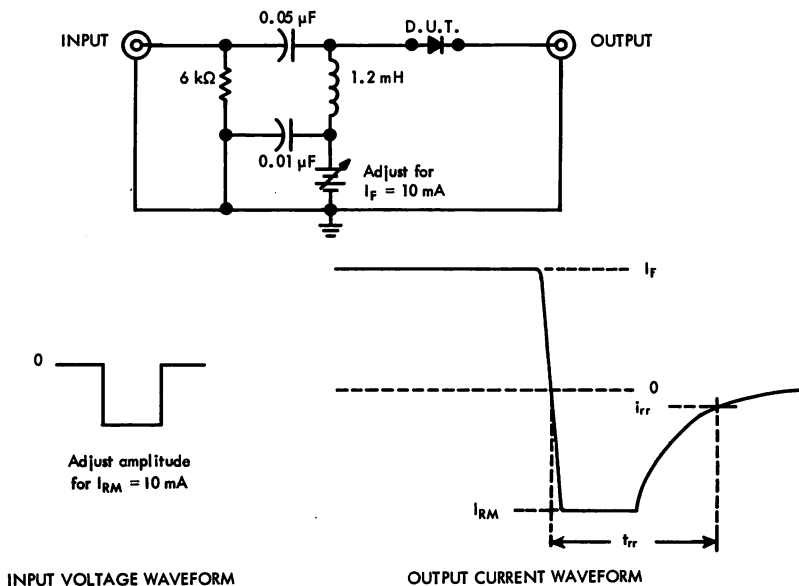

FIGURE 1 — REVERSE RECOVERY TIME

- NOTES: a. The input pulse is supplied by a generator with the following characteristics: $Z_{out} = 50 \Omega$, $t_r \leq 0.25 \text{ ns}$, $t_p = 100 \text{ ns}$.
 b. Output waveform is monitored on an oscilloscope with the following characteristics: $t_r \leq 0.35 \text{ ns}$, $Z_{in} = 50 \Omega$.

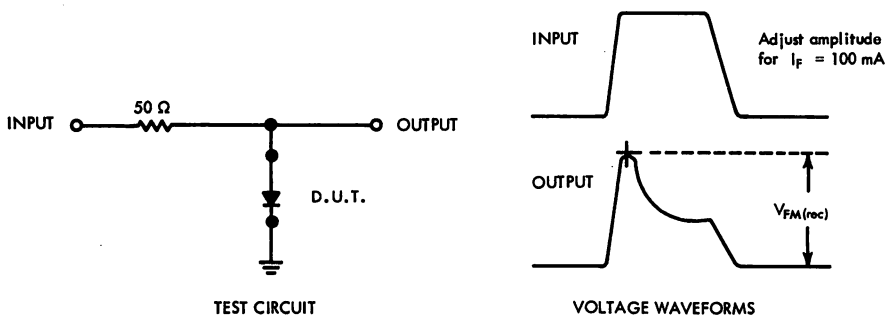

FIGURE 2 — FORWARD RECOVERY VOLTAGE

- NOTES: c. The input pulse is supplied by a generator with the following characteristics: $Z_{out} = 50 \Omega$, $t_r \leq 20 \text{ ns}$, $t_p = 100 \text{ ns}$, $\text{PRR} \leq 100 \text{ kHz}$.
 d. Output waveform is monitored on an oscilloscope with the following characteristics: $t_r \leq 0.4 \text{ ns}$, $R_{in} \geq 1 \text{ M}\Omega$, $C_{in} \leq 5 \text{ pF}$.



WHISKERLESS, DOUBLE-PLUG CONSTRUCTION

mechanical data

The glass-passivated silicon wafer is encased in a hermetically sealed glass package. The high-temperature bond between wafer and leads ensures integral positive contact under extreme environmental conditions.

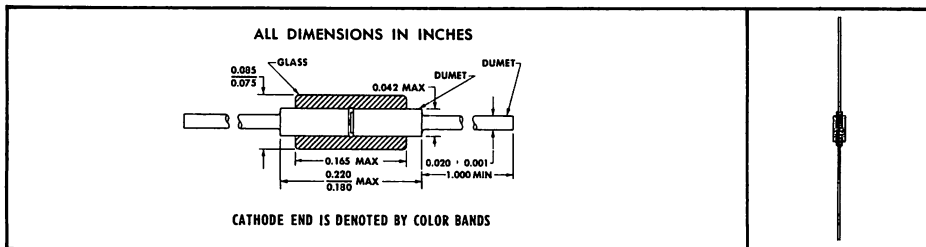

absolute maximum ratings at 25°C free-air temperature (unless otherwise noted)

*V _{RM}	Peak Reverse Voltage	200 V
I _F	Steady-State Forward Current at (or below) 25°C Free-Air Temperature (See Note 1)	150 mA
I _{FM(surge)}	Peak Surge Current, One Second (See Note 2)	500 mA
I _{FM(surge)}	Peak Surge Current, One Microsecond (See Note 2)	2 A
*P	Continuous Power Dissipation at (or below) 25°C Free-Air Temperature (See Note 3)	250 mW
*T _{stg}	Storage Temperature Range	-65°C to 200°C
*T _L	Lead Temperature 1/8 Inch from Case for 2 Seconds	250°C

*electrical characteristics at 25°C free-air temperature (unless otherwise noted)

PARAMETER	TEST CONDITIONS	MIN	MAX	UNIT
V _(BR)	Reverse Breakdown Voltage	I _R = 0.1 mA	200	V
I _R	Static Reverse Current	V _R = 175 V	0.1	μA
		V _R = 175 V, T _A = 150°C	100	μA
V _F	Static Forward Voltage	I _F = 100 mA	1	V
α _{VF}	Temperature Coefficient of Static Forward Voltage	I _F = 100 mA, See Note 4	3	mV/deg
C _T	Total Capacitance	V _R = 0, f = 1 MHz	5	pF

*operating characteristics at 25°C free-air temperature

PARAMETER	TEST CONDITIONS	MIN	MAX	UNIT
t _{rr}	Reverse Recovery Time	I _F = 30 mA, I _{RM} = 30 mA, R _L = 150 Ω, C _L = 10 pF, i _{rr} = 1 mA, See Figure 2	50	ns
η _r	Rectification Efficiency	V _F = 2 V, R _L = 5 kΩ, C _L = 20 pF, Z _{source} = 50 Ω, f = 100 MHz	35 %	

- NOTES: 1. These values may be applied continuously under single-phase 60-Hz half-sine-wave operation with resistive load. Derate linearly to 0 at 200°C free-air temperature.
 2. These values apply for the specified square-wave pulse with the device at nonoperating thermal equilibrium immediately prior to the surge.
 3. For operation above 25°C free-air temperature, refer to Dissipation Derating Curve, Figure 1.
 4. Temperature coefficient, α_{VF}, is determined by the following formula:

$$\alpha_{VF} = \frac{V_F @ 150^\circ\text{C} - V_F @ -55^\circ\text{C}}{150^\circ\text{C} - (-55^\circ\text{C})}$$

†Trademark of Texas Instruments
 *Indicates JEDEC registered data



TYPE 1N3070 DIFFUSED SILICON SWITCHING DIODE

THERMAL INFORMATION

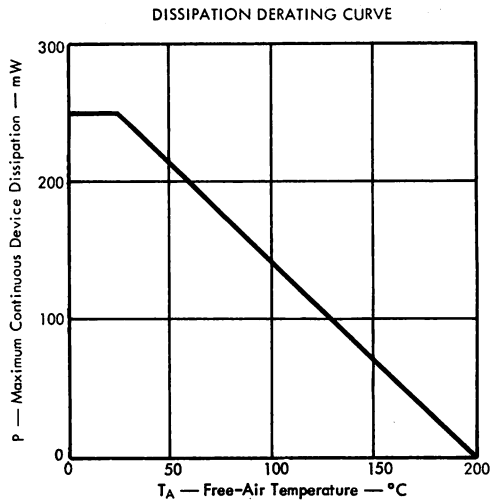

FIGURE 1

PARAMETER MEASUREMENT INFORMATION

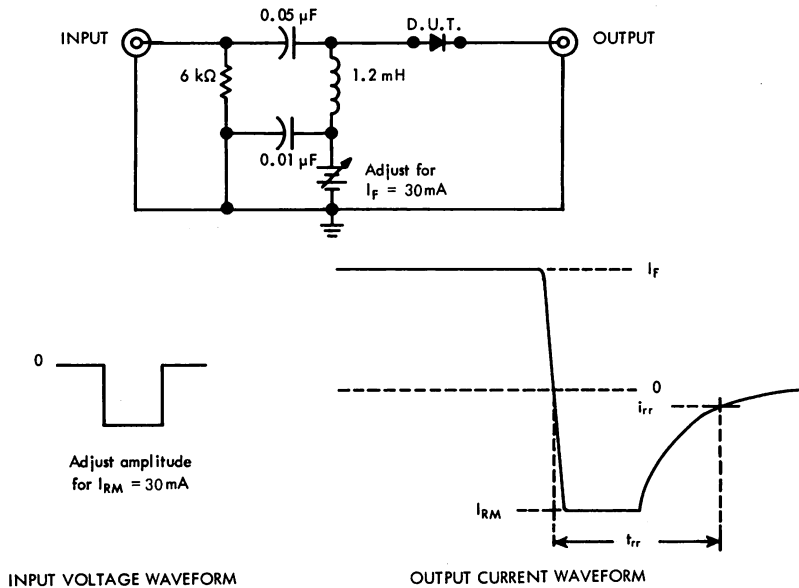

FIGURE 2 — REVERSE RECOVERY TIME

- NOTES: a. The input pulse is supplied by a generator with the following characteristics: $Z_{out} = 50\ \Omega$, $t_r \leq 0.25\ \text{ns}$, $t_p = 100\ \text{ns}$.
 b. The output waveform is monitored on an oscilloscope with the following characteristics: $t_r \leq 0.35\ \text{ns}$, $Z_{in} = 50\ \Omega$.



- Small-Size, Whiskerless, Double-Plug Construction
- Extremely Stable and Reliable High-Speed Diodes

Electrical Equivalents

- 1N4148 • 1N914
- 1N4149 • 1N916
- 1N4446 • 1N914A
- 1N4447 • 1N916A
- 1N4448 • 1N914B
- 1N4449 • 1N916B

mechanical data

The glass-passivated silicon wafer is encased in a hermetically sealed glass package. High-temperature bond between wafer and leads insures integral positive contact under extreme environmental conditions.

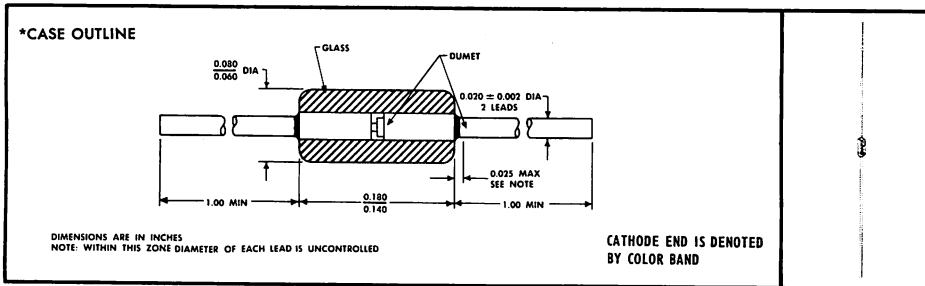

***absolute maximum ratings at 25°C free-air temperature (unless otherwise noted)**

$V_{RM(wtg)}$	Working Peak Reverse Voltage	75 V
P	Continuous Power Dissipation at (or below) 25°C Free-Air Temperature (See Note 1)	500 mW
T_{stg}	Storage Temperature Range	-65°C to 200°C
T_L	Lead Temperature 1/16 Inch from Case for 10 Seconds	300°C

***electrical characteristics at 25°C free-air temperature (unless otherwise noted)**

PARAMETER	TEST CONDITIONS	1N4148	1N4149	1N4446	1N4447	1N4448	1N4449	UNIT		
		MIN MAX	MIN MAX	MIN MAX	MIN MAX	MIN MAX	MIN MAX			
$V_{(BR)}$ Reverse Breakdown Voltage	$I_R = 5 \mu A$	75	75	75	75	75	75	V		
	$I_R = 100 \mu A$	100	100	100	100	100	100	V		
I_R Static Reverse Current	$V_R = 20 V$	25	25	25	25	25	25	nA		
	$V_R = 20 V, T_A = 100^\circ C$					3	3	μA		
	$V_R = 20 V, T_A = 150^\circ C$	50	50	50	50	50	50	μA		
V_F Static Forward Voltage	$I_F = 5 mA$					0.62	0.72	0.63	0.73	V
	$I_F = 10 mA$	1	1						V	
	$I_F = 20 mA$			1	1				V	
	$I_F = 30 mA$							1	V	
	$I_F = 100 mA$						1		V	
C_T Total Capacitance	$V_R = 0, f = 1 MHz$	4	2	4	2	4	2	pF		

NOTE 1: Derate linearly to 200°C at the rate of 2.85 mW/deg.

†Trademark of Texas Instruments

*Indicates JEDEC registered data

TYPES 1N4148, 1N4149, 1N4446, 1N4447, 1N4448, 1N4449

PLANAR SILICON SWITCHING DIODES

*switching characteristics at 25°C free-air temperature

PARAMETER	TEST CONDITIONS	1N4148	1N4149	1N4446	1N4447	1N4448	1N4449	UNIT
		MIN MAX	MIN MAX	MIN MAX	MIN MAX	MIN MAX	MIN MAX	
t_{rr} Reverse Recovery Time	$I_F = 10 \text{ mA}$, $V_R = 6 \text{ V}$, $i_{rr} = 1 \text{ mA}$, $R_L = 100 \Omega$, See Figure 1		4	4	4	4	4	ns
$V_{FM(rec)}$ Forward Recovery Voltage	$I_F = 50 \text{ mA}$, $R_L = 50 \Omega$, See Figure 2					2.5	2.5	V

*PARAMETER MEASUREMENT INFORMATION

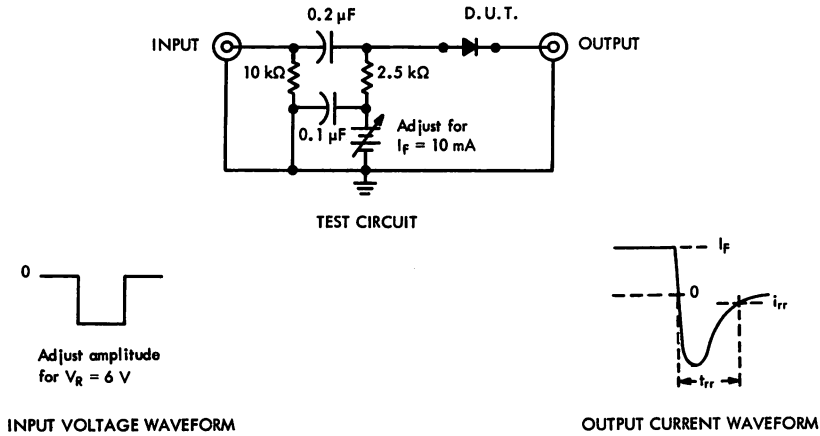

FIGURE 1 — REVERSE RECOVERY TIME

- NOTES: a. The input pulse is supplied by a generator with the following characteristics: $Z_{out} = 50 \Omega$, $t_r \leq 0.5 \text{ ns}$, $t_p = 100 \text{ ns}$.
b. The output waveform is monitored on an oscilloscope with the following characteristics: $t_r \leq 0.6 \text{ ns}$, $Z_{in} = 50 \Omega$.

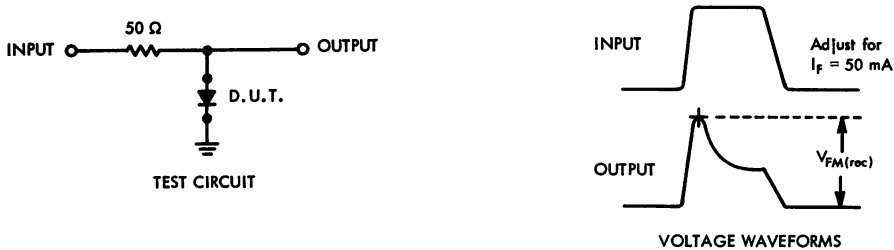

FIGURE 2 — FORWARD RECOVERY VOLTAGE

- NOTES: c. The input pulse is supplied by a generator with the following characteristics: $Z_{out} = 50 \Omega$, $t_r \leq 30 \text{ ns}$, $t_p = 100 \text{ ns}$, $PRR = 5 \text{ to } 100 \text{ kHz}$.
d. The output waveform is monitored on an oscilloscope with the following characteristics: $t_r \leq 15 \text{ ns}$, $R_{in} \geq 1 \text{ M}\Omega$, $C_{in} \leq 5 \text{ pF}$.

*Indicates JEDEC registered data



- Small-Size, Whiskerless, Double-Plug Construction
- Extremely Stable and Reliable High-Speed Diodes
- 1N4305 Electrically Equivalent to 1N3063
- 1N4454 Electrically Equivalent to 1N3064

mechanical data

The glass-passivated silicon wafer is encased in a hermetically sealed glass package. High-temperature bond between wafer and leads insures integral positive contact under extreme environmental conditions.

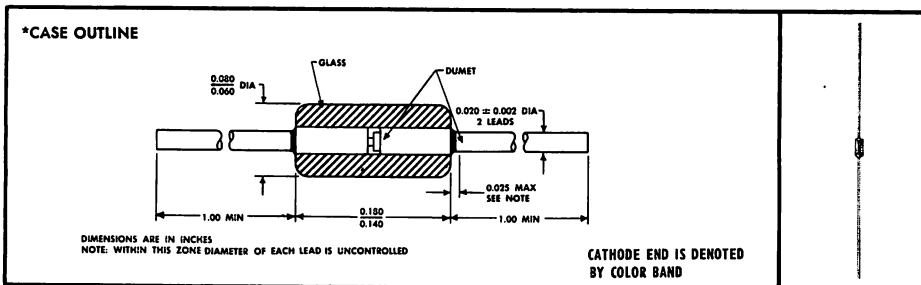

*absolute maximum ratings at 25°C free-air temperature (unless otherwise noted)

	1N4305	1N4444	1N4454	UNIT
V_{RM} Peak Reverse Voltage	75		75	V
$V_{RM(wtg)}$ Working Peak Reverse Voltage		50		V
P Continuous Power Dissipation at (or below) 25°C Free-Air Temperature (See Note 1)	500			mW
T_{stg} Storage Temperature Range	-65 to 200			°C
T_L Lead Temperature 1/16 Inch from Case for 10 Seconds	300			°C

*electrical characteristics at 25°C free-air temperature (unless otherwise noted)

PARAMETER	TEST CONDITIONS	1N4305		1N4444		1N4454		UNIT
		MIN	MAX	MIN	MAX	MIN	MAX	
$V_{(BR)}$ Reverse Breakdown Voltage	$I_R = 5 \mu A$	75		70		75		V
I_R Static Reverse Current	$V_R = 50 V$	0.1		0.05		0.1		μA
	$V_R = 50 V, T_A = 150^\circ C$	100		50		100		μA
V_F Static Forward Voltage	$I_F = 0.1 mA$			0.44	0.55			V
	$I_F = 0.25 mA$	0.505	0.575					V
	$I_F = 1 mA$	0.55	0.65	0.56	0.68			V
	$I_F = 2 mA$	0.61	0.71					V
	$I_F = 10 mA$	0.70	0.85	0.69	0.82	1		V
	$I_F = 100 mA$			0.85	1			V
α_{VF} Forward Voltage Temperature Coefficient	$I_F = 10 \mu A$ to 10 mA, See Note 2	3						mV/deg
C_T Total Capacitance	$V_R = 0, f = 1 MHz$	2		2		2		pF

NOTES: 1. Derate linearly to 200°C at the rate of 2.85 mW/deg.
 2. Temperature coefficient, α_{VF} , is determined by the following formula:

$$\alpha_{VF} = \frac{V_F @ 150^\circ C - V_F @ -55^\circ C}{150^\circ C - (-55^\circ C)}$$

†Trademark of Texas Instruments
 *Indicates JEDEC registered data



TYPES 1N4305, 1N4444, 1N4454 PLANAR SILICON SWITCHING DIODES

*operating characteristics at 25°C free-air temperature

PARAMETER	TEST CONDITIONS	1N4305		1N4444		1N4454		UNIT
		MIN	MAX	MIN	MAX	MIN	MAX	
t_{rr} Reverse Recovery Time	$I_F = 10 \text{ mA}$, $I_{RM} = 10 \text{ mA}$, $i_{rr} = 1 \text{ mA}$, $R_L = 100 \Omega$, See Figure 1, Condition 1		4		7		4	ns
	$I_F = 10 \text{ mA}$, $V_R = 6 \text{ V}$, $i_{rr} = 1 \text{ mA}$, $R_L = 100 \Omega$, See Figure 1, Condition 2		2				2	ns
$V_{FM(rec)}$ Forward Recovery Voltage	$I_F = 100 \text{ mA}$, $R_L = 50 \Omega$, See Figure 2						3	V
η_r Rectification Efficiency	$V_r = 2 \text{ V}$, $R_L = 5 \text{ k}\Omega$, $C_L = 20 \text{ pF}$, $Z_{source} = 50 \Omega$, $f = 100 \text{ MHz}$	45						%

*PARAMETER MEASUREMENT INFORMATION

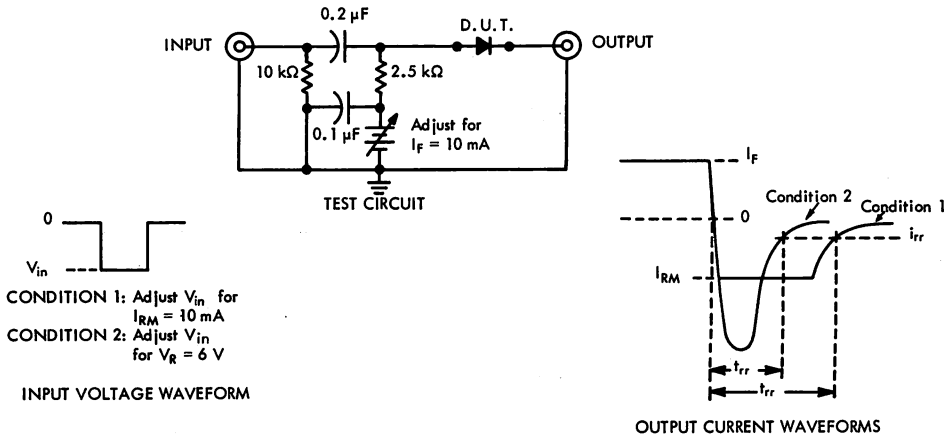

FIGURE 1 — REVERSE RECOVERY TIME

- NOTES: a. The input pulse is supplied by a generator with the following characteristics: $Z_{out} = 50 \Omega$, $t_r \leq 0.5 \text{ ns}$, $t_p = 100 \text{ ns}$.
b. Output waveforms are monitored on an oscilloscope with the following characteristics: $t_r \leq 0.6 \text{ ns}$, $Z_{in} = 50 \Omega$.

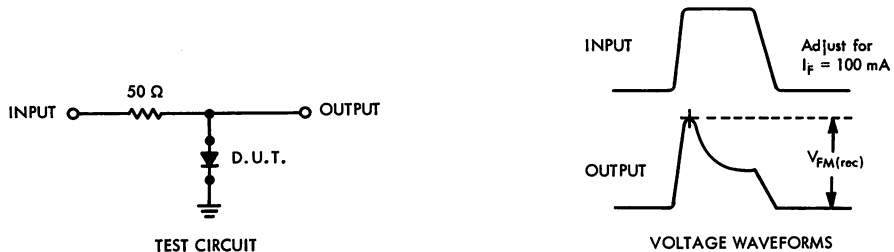

FIGURE 2 — FORWARD RECOVERY VOLTAGE

- NOTES: c. The input pulse is supplied by a generator with the following characteristics: $Z_{out} = 50 \Omega$, $t_r \leq 30 \text{ ns}$, $t_p = 100 \text{ ns}$, $PRR = 5$ to 100 kHz .
d. The output waveform is monitored on an oscilloscope with the following characteristics: $t_r \leq 15 \text{ ns}$, $R_{in} \geq 1 \text{ M}\Omega$, $C_{in} \leq 5 \text{ pF}$.

*Indicates JEDEC registered data.

- Microminiature, Whiskerless, Double-Plug Construction
- Extremely Stable and Reliable High-Speed Diodes

Electrical Equivalents

1N4531 • 1N914 1N4532 • 1N3064
 1N4533 • 1N3605 1N4534 • 1N3606
 1N4536 • 1N4009

mechanical data

The glass-passivated planar silicon wafer is encased in a hermetically sealed glass package. High-temperature bond between wafer and leads insures integral positive contact under extreme environmental conditions.

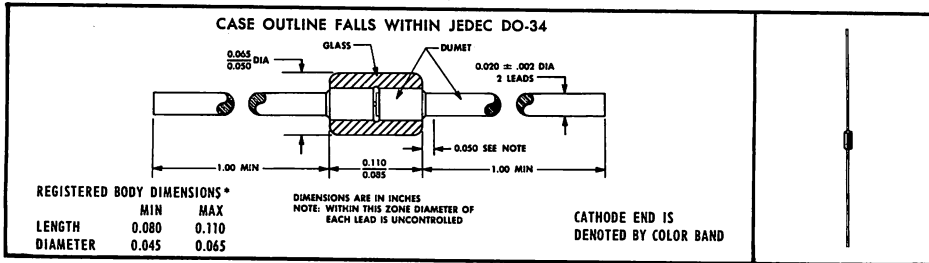

absolute maximum ratings at 25°C free-air temperature (unless otherwise noted)

	1N4531	1N4532	1N4533	1N4534	1N4536	UNIT
V_{RM} Peak Reverse Voltage	75	75	40	75	35	V
$*V_{RM(wkg)}$ Working Peak Reverse Voltage	75	75	40	50	25	V
$*P$ Continuous Power Dissipation at (or below) 25°C Free-Air Temperature (See Note 1)	500					mW
$*T_{stg}$ Storage Temperature Range	-65 to 200					°C
$*T_L$ Lead Temperature $\frac{1}{16}$ Inch from Case for 10 Seconds	300					°C

*electrical characteristics at 25°C free-air temperature (unless otherwise noted)

PARAMETER	TEST CONDITIONS	1N4531	1N4532	1N4533	1N4534	1N4536	UNIT
		MIN MAX	MIN MAX	MIN MAX	MIN MAX	MIN MAX	
$V_{(BR)}$ Reverse Breakdown Voltage	$I_R = 5 \mu A$	75	75	40	75	35	V
	$I_R = 100 \mu A$	100					V
I_R Static Reverse Current	$V_R = 20 V$	0.025					μA
	$V_R = 20 V, T_A = 150^\circ C$	50					μA
	$V_R = 25 V$					0.1	μA
	$V_R = 25 V, T_A = 150^\circ C$					100	μA
	$V_R = 30 V$			0.05			μA
	$V_R = 30 V, T_A = 150^\circ C$			50			μA
	$V_R = 50 V$		0.1		0.05		μA
	$V_R = 50 V, T_A = 150^\circ C$		100		50		μA
V_F Static Forward Voltage	$I_F = 0.1 mA$			0.49 0.55	0.49 0.55		V
	$I_F = 0.25 mA$			0.53 0.59	0.53 0.59		V
	$I_F = 1 mA$			0.59 0.67	0.59 0.67		V
	$I_F = 2 mA$			0.62 0.70	0.62 0.70		V
	$I_F = 10 mA$	1	1	0.70 0.81	0.70 0.81		V
	$I_F = 20 mA$			0.74 0.88	0.74 0.88		V
	$I_F = 30 mA$						1 V
C_T Total Capacitance	$V_R = 0, f = 1 MHz$	4	2	2	2	1	pF

NOTE 1: Derate linearly to 200°C free-air temperature at the rate of 2.85 mW/dag.

†Trademark of Texas Instruments
 *Indicates JEDEC registered data

TYPES 1N4531 THRU 1N4534, 1N4536

PLANAR SILICON SWITCHING DIODES

*operating characteristics at 25°C free-air temperature

PARAMETER	TEST CONDITIONS	1N4531	1N4532	1N4533	1N4534	1N4536	UNIT
		MIN	MAX	MIN	MAX	MIN	
t_{rr} Reverse Recovery Time	$I_F = 10 \text{ mA}$, $I_{RM} = 10 \text{ mA}$, $i_{rr} = 1 \text{ mA}$, $R_L = 100 \Omega$, See Figure 1, Condition 1		4	4	4	4	ns
	$I_F = 10 \text{ mA}$, $V_R = 6 \text{ V}$, $i_{rr} = 1 \text{ mA}$, $R_L = 100 \Omega$, See Figure 1, Condition 2	4	2	2	2	2	ns
$V_{FM(rec)}$ Forward Recovery Voltage	$I_F = 100 \text{ mA}$, $R_L = 50 \Omega$, See Figure 2		3				V

*PARAMETER MEASUREMENT INFORMATION

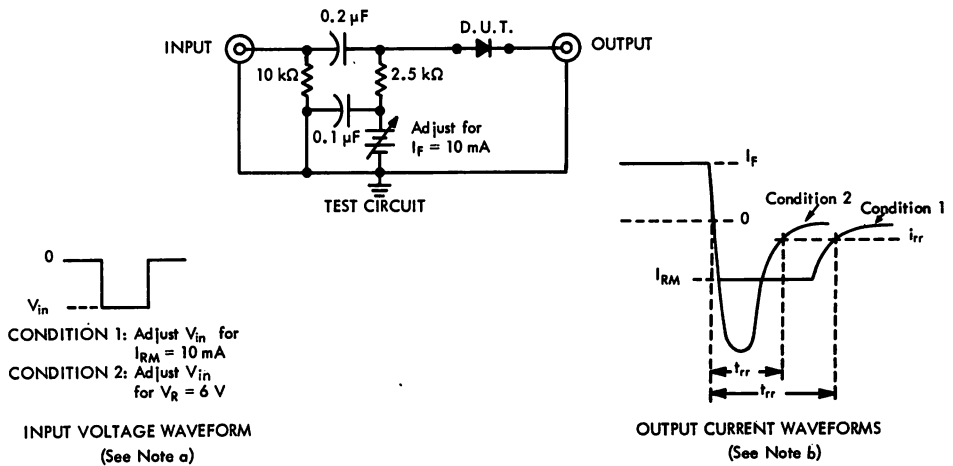

FIGURE 1 — REVERSE RECOVERY TIME

- NOTES: a. The input pulse is supplied by a generator with the following characteristics: $Z_{out} = 50 \Omega$, $t_r \leq 0.5 \text{ ns}$, $t_p = 100 \text{ ns}$.
 b. Output waveforms are monitored on an oscilloscope with the following characteristics: $t_r \leq 0.6 \text{ ns}$, $Z_{in} = 50 \Omega$.

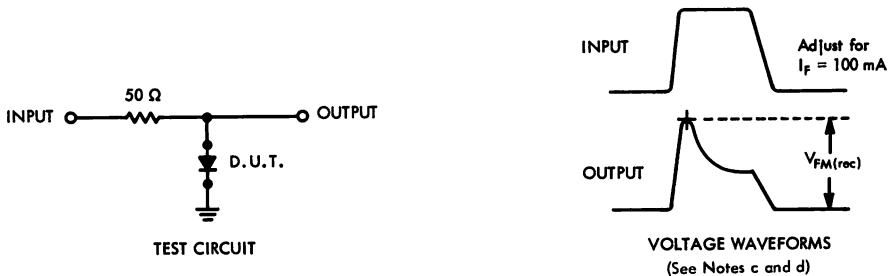

FIGURE 2 — FORWARD RECOVERY VOLTAGE

- NOTES: c. The input pulse is supplied by a generator with the following characteristics: $Z_{out} = 50 \Omega$, $t_r \leq 30 \text{ ns}$, $t_p = 100 \text{ ns}$, $PRR = 5 \text{ to } 100 \text{ kHz}$.
 d. The output waveform is monitored on an oscilloscope with the following characteristics: $t_r \leq 15 \text{ ns}$, $R_{in} \geq 1 \text{ M}\Omega$, $C_{in} \leq 5 \text{ pF}$.

*Indicates JEDEC registered data

TYPES TID21, TID22, TID23, TID24 EPITAXIAL PLANAR SILICON 8-DIODE ARRAYS



TYPES TID21, TID22, TID23, TID24
BULLETIN NO. DI-5 669405, OCTOBER 1966
REPLACES BULLETIN NO. DI-5 657541, MAY 1965

8-DIODE CORE DRIVERS For Application With Magnetic Cores • Memory Drums • Memory Tapes Magnetic Discs • Diode-Capacitor Storage

mechanical data

The diode arrays are mounted in a glass-to-metal hermetically sealed, welded package which falls within the JEDEC TO-89 outline. Leads are goldplated F-15† glass-sealing alloy. Approximate weight is 0.1 gram. All external surfaces are metallic.

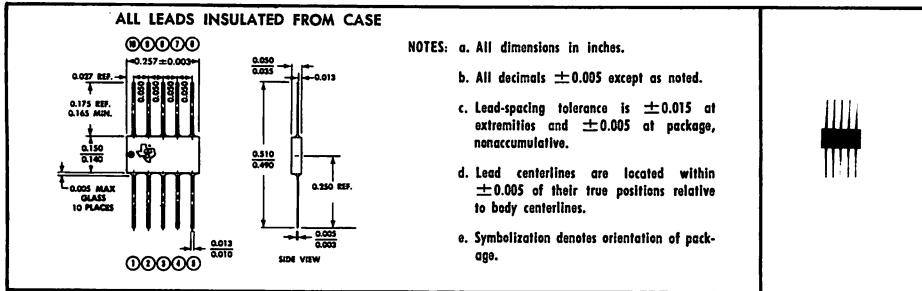

†F-15 is the ASTM designation for an iron-nickel-cobalt alloy containing nominally 29% nickel, 17% cobalt, and 53% iron.

schematic diagrams

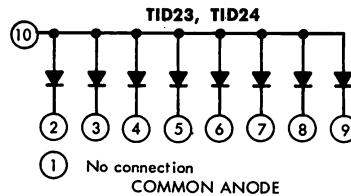
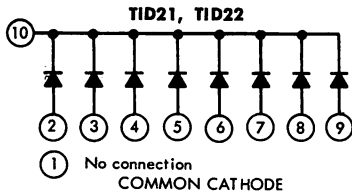

absolute maximum ratings at 25°C free-air temperature (unless otherwise noted)

	EACH DIODE		TOTAL DEVICE ALL TYPES	UNIT
	TID21 TID23	TID22 TID24		
Peak Reverse Voltage (See Note 1)	60	40		V
Steady State Reverse Voltage, V_R	30	15		V
Peak Forward Current at (or below) 25°C Free-Air Temperature (See Notes 1, 2, and 3)	500		500	mA
Continuous Forward Current at (or below) 25°C Free-Air Temperature (See Notes 2 and 4)	100		200	mA
Storage Temperature Range	-65 to 200			°C
Lead Temperature $\frac{1}{8}$ Inch From Case for 10 Seconds	300			°C

- NOTES:
1. These values apply for 100- μ s pulses, duty cycle $\leq 20\%$.
 2. The values shown for total device apply for any combination provided the ratings of individual diodes are not exceeded.
 3. Derate linearly to 150°C free-air temperature at the rate of 4 mA/deg.
 4. Derate linearly to 150°C free-air temperature at the rate of 0.8 mA/deg for each diode and 1.6 mA/deg for the total device.



TEXAS INSTRUMENTS
INCORPORATED
POST OFFICE BOX 5012 • DALLAS, TEXAS 75222

20005

TYPES TID21, TID22, TID23, TID24

EPITAXIAL PLANAR SILICON 8-DIODE ARRAYS

electrical characteristics at 25°C free-air temperature

single-diode operation (see note 5)

PARAMETER	TEST CONDITIONS	TID21		TID22		TID23		TID24		UNIT
		MIN	MAX	MIN	MAX	MIN	MAX	MIN	MAX	
$V_{(BR)}$ Reverse Breakdown Voltage	$I_R = 10 \mu A$	60		40		60		40		V
I_R Static Reverse Current	$V_R = 30 V$	0.1				0.1				μA
	$V_R = 15 V$			0.1				0.1		μA
V_F Static Forward Voltage	$I_F = 100 mA$	1		1.1		1		1.1		V
V_F Instantaneous Forward Voltage	$I_F = 500 mA$, See Note 6	1.3		1.5		1.3		1.5		V
V_{FM} Peak Forward Voltage	$I_F = 500 mA$, See Note 7	5		5		5		5		V
C_T Total Capacitance	$V_R = 0$, $f = 1 MHz$	4		4		7		7		pF

multiple-diode operation (see note 8)

PARAMETER	TEST CONDITIONS	TID21		TID22		TID23		TID24		UNIT
		MIN	MAX	MIN	MAX	MIN	MAX	MIN	MAX	
I_{R1} Static Reverse Current	$V_{R1} = \text{rated } V_R$, $I_{FN} = 25 mA$	10		10		10		10		μA
V_{F1} Static Forward Voltage	$I_{F1} = I_{FN} = 25 mA$	1		1		1		1		V

switching characteristics at 25°C free-air temperature

single-diode operation (see note 5)

PARAMETER	TEST CONDITIONS	ALL TYPES		UNIT
		MAX		
t_{fr} Forward Recovery Time	$I_F = 500 mA$, See Figure 2	40		ns
t_{rr} Reverse Recovery Time	$I_F = 200 mA$, $I_{RM} = 200 mA$, $R_L = 100 \Omega$, $i_{rr} = 20 mA$, See Figure 3	20		ns

NOTES: 5. Test conditions and limits apply separately to each of the diodes. The diodes not under test are open-circuited during the measurement of these characteristics.

6. This parameter is measured using pulse techniques. $t_p = 100 \mu s$, duty cycle $\leq 2\%$. Read time is 90 μs from leading edge of the pulse.

7. The initial instantaneous value is measured using pulse techniques. $t_p = 150 \mu s$, duty cycle $\leq 2\%$, pulse rise time $\leq 10 ns$. The total diode shunt capacitance is 19 pF max and the equipment bandwidth is 80 MHz.

8. Subscript numeral 1 refers to the diode under test; subscript N refers simultaneously to each of the other diodes. Each diode is individually tested after the device reaches operating thermal equilibrium.

TYPES TID21, TID22, TID23, TID24 EPITAXIAL PLANAR SILICON 8-DIODE ARRAYS

TYPICAL CHARACTERISTICS

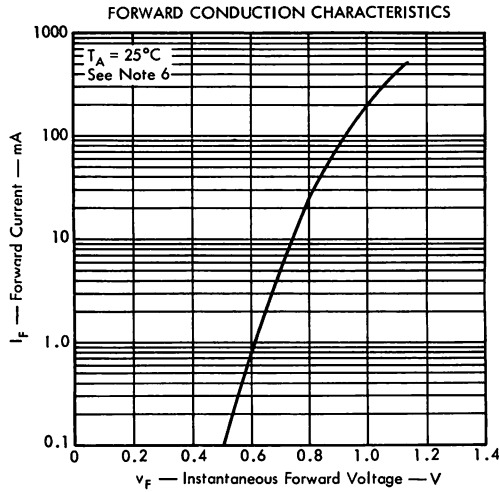

FIGURE 1

PARAMETER MEASUREMENT INFORMATION

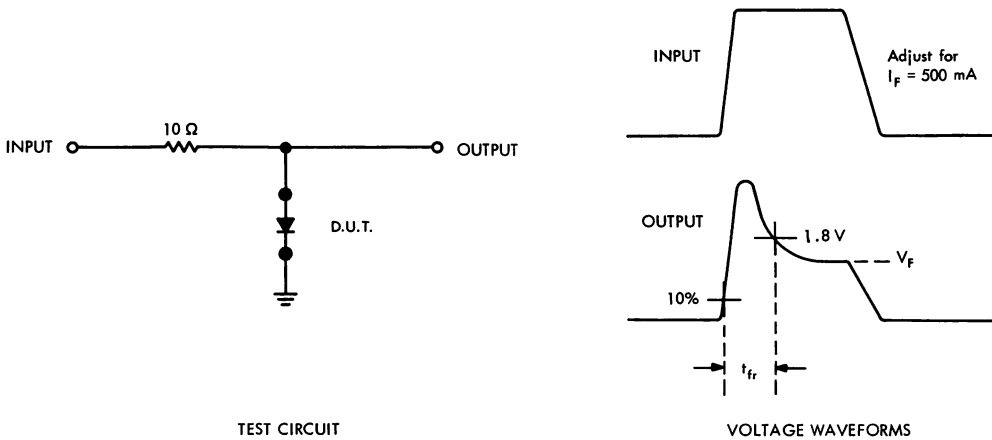

FIGURE 2 — FORWARD RECOVERY TIME

- NOTES: a. The input pulse is supplied by a generator with the following characteristics: $t_r \leq 15 \text{ ns}$, $Z_{out} = 50 \Omega$, $PW = 150 \text{ ns}$, duty cycle $\leq 2\%$.
 b. The output waveform is monitored on an oscilloscope with the following characteristics: $t_r \leq 4.5 \text{ ns}$, $R_{in} \geq 1 \text{ M}\Omega$, $C_{in} \leq 5 \text{ pF}$.

TYPES TID21, TID22, TID23, TID24 EPITAXIAL PLANAR SILICON 8-DIODE ARRAYS

PARAMETER MEASUREMENT INFORMATION

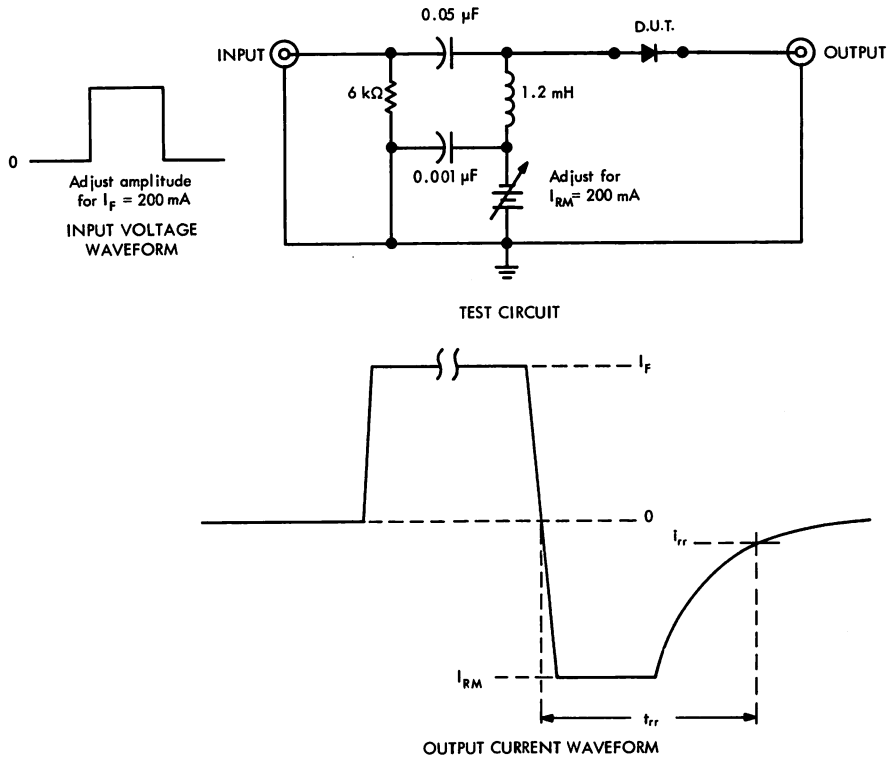

FIGURE 3 — REVERSE RECOVERY TIME

- NOTES: c. The input pulse is supplied by a generator with the following characteristics: $t_f \leq 1 \text{ ns}$, $Z_{out} = 50 \Omega$, $t_p = 200 \text{ ns}$, duty cycle $\leq 1\%$.
d. The output waveform is monitored on an oscilloscope with the following characteristics: $t_r \leq 0.4 \text{ ns}$, $R_{in} = 50 \Omega$.

TYPES TID25, TID26 EPITAXIAL PLANAR SILICON 16-DIODE ARRAYS



TYPES TID25, TID26
BULLETIN NO. DI-5 669403, OCTOBER 1966
REPLACES BULLETIN NO. DI-5 657340, MAY 1965

16-DIODE CORE DRIVERS

For Application With
Magnetic Cores • Memory Drums • Memory Tapes
Diode-Capacitor Storage • Magnetic Discs

mechanical data

The diode arrays are mounted in a glass-to-metal hermetically sealed, welded package which falls within the JEDEC TO-89 outline. Leads are goldplated F-15† glass-sealing alloy. Approximate weight is 0.1 gram. All external surfaces are metallic.

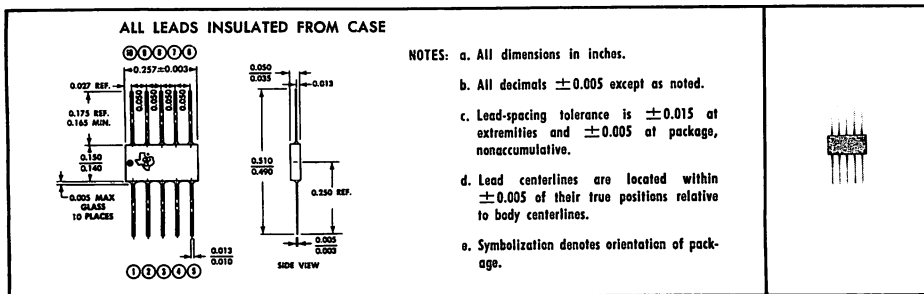

†F-15 is the ASTM designation for an iron-nickel-cobalt alloy containing nominally 29% nickel, 17% cobalt, and 53% iron.

schematic diagrams

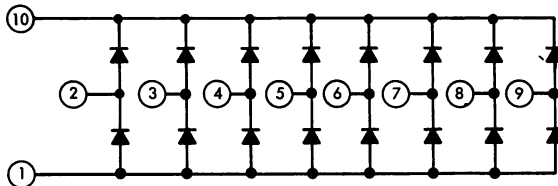

absolute maximum ratings at 25°C free-air temperature (unless otherwise noted)

	EACH DIODE		TOTAL DEVICE ALL TYPES	UNIT
	TID25	TID26		
Peak Reverse Voltage (See Note 1)	60	40		V
Steady State Reverse Voltage, V_R	30	15		V
Peak Forward Current at (or below) 25°C Free-Air Temperature (See Notes 1, 2, and 3)	500		500	mA
Continuous Forward Current at (or below) 25°C Free-Air Temperature (See Notes 2 and 4)	100		200	mA
Storage Temperature Range	-65 to 200			°C
Lead Temperature $\frac{1}{16}$ Inch From Case for 10 Seconds	300			°C

NOTES: 1. These values apply for 100- μ s pulses, duty cycle $\leq 20\%$.

2. The values shown for total device apply for any combination provided the ratings of individual diodes are not exceeded.

3. Derate linearly to 150°C free-air temperature at the rate of 4 mA/deg.

4. Derate linearly to 150°C free-air temperature at the rate of 0.8 mA/deg for each diode and 1.6 mA/deg for the total device.



TEXAS INSTRUMENTS
INCORPORATED
POST OFFICE BOX 5012 • DALLAS, TEXAS 75222

TYPES TID25, TID26

EPITAXIAL PLANAR SILICON 16-DIODE ARRAYS

electrical characteristics at 25°C free-air temperature

single-diode operation (see note 5)

PARAMETER	TEST CONDITIONS	TID25		TID26		UNIT
		MIN	MAX	MIN	MAX	
$V_{(BR)}$ Reverse Breakdown Voltage	$I_R = 10 \mu A$	60		40		V
I_R Static Reverse Current	$V_R = 30 V$, See Note 6	0.1				μA
	$V_R = 15 V$, See Note 6			0.1		μA
V_F Static Forward Voltage	$I_F = 100 mA$		1		1.1	V
V_F Instantaneous Forward Voltage	$I_F = 500 mA$, See Note 7		1.3		1.5	V
V_{FM} Peak Forward Voltage	$I_F = 500 mA$, See Note 8		5		5	V
C_T Total Capacitance †	$V_R = 0$, $f = 1 MHz$		8		8	pF

multiple-diode operation (see note 9)

PARAMETER	TEST CONDITIONS	TID25		TID26		UNIT
		MIN	MAX	MIN	MAX	
I_{R1} Static Reverse Current	$V_{R1} = \text{rated } V_R$, $I_{FN} = 25 mA$		10		10	μA
V_{F1} Static Forward Voltage	$I_{F1} = I_{FN} = 25 mA$		1		1	V

switching characteristics at 25°C free-air temperature

single-diode operation (see note 5)

PARAMETER	TEST CONDITIONS	ALL TYPES		UNIT
		MAX		
t_{fr} Forward Recovery Time	$I_F = 500 mA$, See Figure 3	40		ns
t_{rr} Reverse Recovery Time	$I_F = 200 mA$, $I_{RM} = 200 mA$, $R_L = 100 \Omega$, $i_{rr} = 20 mA$, See Figure 4	20		ns

NOTES: 5. Test conditions and limits apply separately to each of the diodes. The diodes not under test are open-circuited during the measurement of these characteristics, except for I_R as shown in Figures 1 and 2.

6. See figures 1 and 2, Parameter Measurement Information section.

7. This parameter is measured using pulse techniques. $t_p = 100 \mu s$, duty cycle = 2%. Read time is 90 μs from leading edge of the pulse.

8. The initial instantaneous value is measured using pulse techniques. $t_p = 150 \mu s$, duty cycle $\leq 2\%$, pulse rise time $\leq 10 ns$. The total diode shunt capacitance is 19 pF max and the equipment bandwidth is 80 MHz.

9. Test conditions apply separately to the common-anode and common-cathode sections. Subscript numeral 1 refers to the diode under test; subscript N refers simultaneously to each of the other diodes in the section. Each diode is individually tested after the device reaches operating thermal equilibrium.

† C_T is the total pin-to-pin capacitance measured across any of the diodes. The interaction of the other diodes cannot easily be separated out unless three-terminal guarded measurement techniques are used. The actual capacitance of a single, isolated diode will typically be 30% of the measured pin-to-pin value for the common-cathode diodes, and 75% of the measured value for the common-anode diodes.

TYPES TID25, TID26 EPITAXIAL PLANAR SILICON 16-DIODE ARRAYS

PARAMETER MEASUREMENT INFORMATION

When measuring the reverse current of an individual diode the current meter must be placed so that the shunt current through the other diodes is bypassed around the meter. To obtain accurate readings, the voltage drop across the current meter must be less than 10 mV.

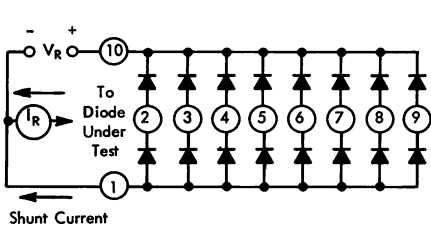

FIGURE 1 - TEST CIRCUIT FOR
COMMON-CATHODE DIODE

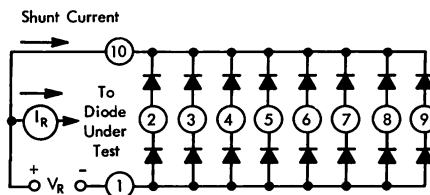
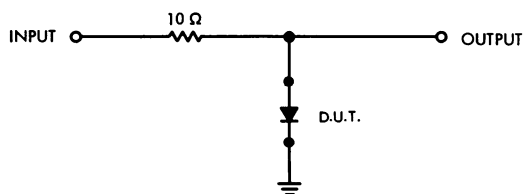
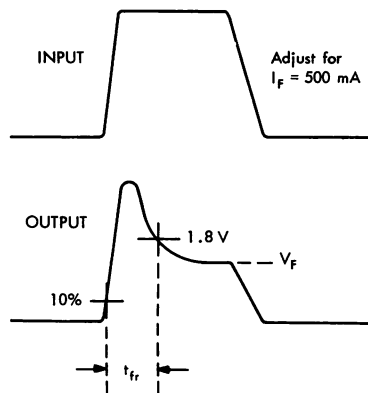

FIGURE 2 - TEST CIRCUIT FOR
COMMON-ANODE DIODE



TEST CIRCUIT



VOLTAGE WAVEFORMS

FIGURE 3 — FORWARD RECOVERY TIME

- NOTES: a. The input pulse is supplied by a generator with the following characteristics: $t_r \leq 15$ ns, $Z_{out} = 50 \Omega$, $t_p = 150$ ns, duty cycle $\leq 2\%$.
b. The output waveform is monitored on an oscilloscope with the following characteristics: $t_r \leq 4.5$ ns, $R_{in} \geq 1$ M Ω , $C_{in} \leq 5$ pF.

TYPES TID25, TID26 EPITAXIAL PLANAR SILICON 16-DIODE ARRAYS

PARAMETER MEASUREMENT INFORMATION

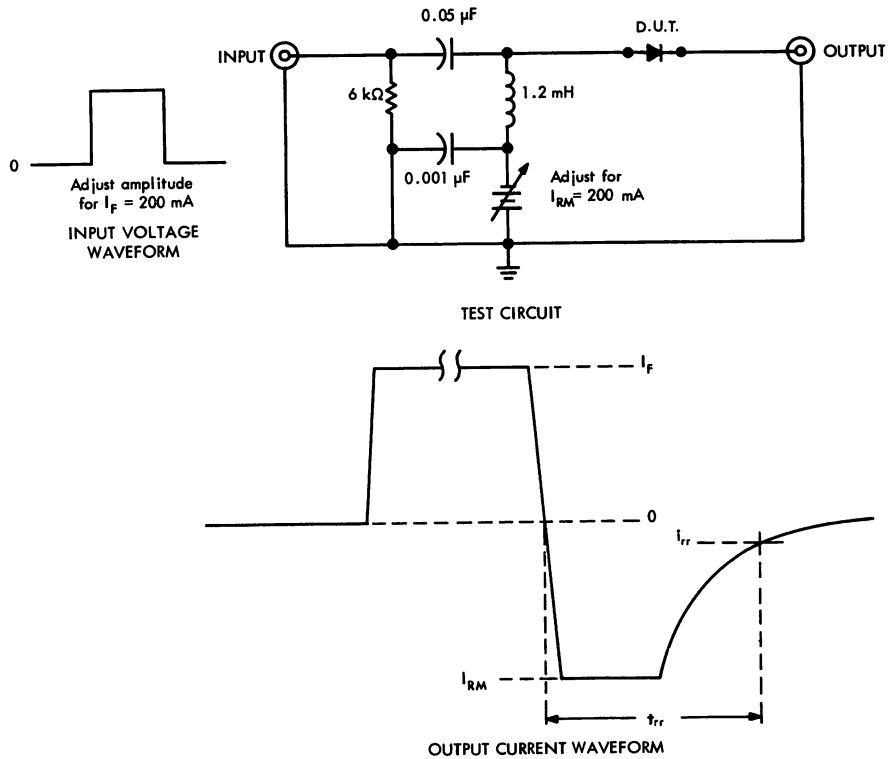

FIGURE 4 — REVERSE RECOVERY TIME

- NOTES: c. The input pulse is supplied by a generator with the following characteristics: $t_f \leq 1\text{ ns}$, $Z_{out} = 50\ \Omega$, $t_p = 200\text{ ns}$, duty cycle $\leq 1\%$.
 d. The output waveform is monitored on an oscilloscope with the following characteristics: $t_r \leq 0.4\text{ ns}$, $R_{in} = 50\ \Omega$.

TYPES TID29, TID30 EPITAXIAL PLANAR SILICON DUAL 10-DIODE ARRAYS



TYPES TID29, TID30
BULLETIN NO. DI-5 669404, OCTOBER 1966
REPLACES BULLETIN NO. DI-5 658007, AUGUST 1965

20-DIODE CORE DRIVERS

For Application With
Magnetic Cores • Memory Drums • Memory Tapes
Diode-Capacitor Storage • Magnetic Discs
Convenient Input/Output Lead Arrangement

mechanical data

The diode arrays are mounted in a glass-to-metal hermetically sealed, welded package which falls within the JEDEC TO-84 outline. Leads are goldplated F-15† glass-sealing alloy. Approximate weight is 0.1 gram. All external surfaces are metallic.

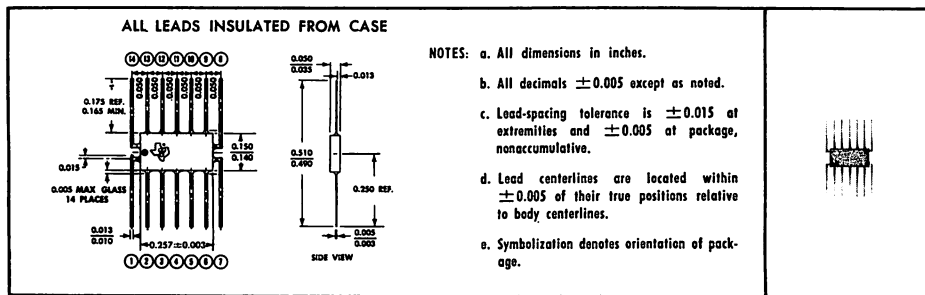

†F-15 is the ASTM designation for an iron-nickel-cobalt alloy containing nominally 29% nickel, 17% cobalt, and 53% iron.

schematic diagrams

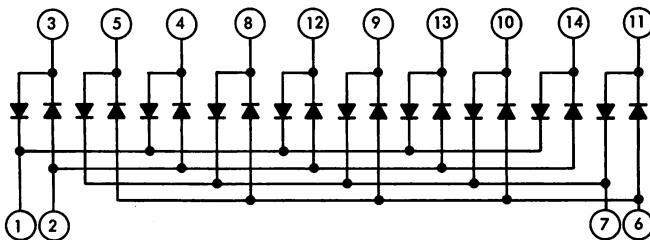

absolute maximum ratings at 25°C free-air temperature (unless otherwise noted)

	EACH DIODE		TOTAL DEVICE	UNIT
	TID29	TID30	ALL TYPES	
Peak Reverse Voltage (See Note 1)	60	40		V
Steady State Reverse Voltage, V_R	30	15		V
Peak Forward Current at (or below) 25°C Free-Air Temperature (See Notes 1, 2, and 3)	500		500	mA
Continuous Forward Current at (or below) 25°C Free-Air Temperature (See Notes 2 and 4)	100		200	mA
Storage Temperature Range	-65 to 200			°C
Lead Temperature $\frac{1}{8}$ Inch From Case for 10 Seconds	300			°C

- NOTES: 1. These values apply for 100- μ s pulses, duty cycle $\leq 20\%$.
2. The values shown for total device apply for any combination provided the ratings of individual diodes are not exceeded.
3. Derate linearly to 150°C free-air temperature at the rate of 4 mA/deg.
4. Derate linearly to 150°C free-air temperature at the rate of 0.8 mA/deg for each diode and 1.6 mA/deg for the total device.



TEXAS INSTRUMENTS
INCORPORATED
POST OFFICE BOX 9012 • DALLAS, TEXAS 75222

TYPES TID29, TID30

EPITAXIAL PLANAR SILICON DUAL 10-DIODE ARRAYS

electrical characteristics at 25°C free-air temperature

single-diode operation (see note 5)

PARAMETER	TEST CONDITIONS	TID29		TID30		UNIT
		MIN	MAX	MIN	MAX	
$V_{(BR)}$ Reverse Breakdown Voltage	$I_R = 10 \mu A$	60		40		V
I_R Static Reverse Current	$V_R = 30 V$, See Note 6		0.1			μA
	$V_R = 15 V$, See Note 6			0.1		μA
V_F Static Forward Voltage	$I_F = 100 mA$		1	1.1		V
v_F Instantaneous Forward Voltage	$I_F = 500 mA$, See Note 7		1.3	1.5		V
V_{FM} Peak Forward Voltage	$I_F = 500 mA$, See Note 8		5	5		V
C_T Total Capacitance †	$V_R = 0$, $f = 1 MHz$		8	8		pF

multiple-diode operation (see note 9)

PARAMETER	TEST CONDITIONS	TID29		TID30		UNIT
		MIN	MAX	MIN	MAX	
I_{R1} Static Reverse Current	$V_{R1} = \text{rated } V_R$, $I_{FN} = 25 mA$		10	10		μA
V_{F1} Static Forward Voltage	$I_{F1} = I_{FN} = 25 mA$		1	1		V

switching characteristics at 25°C free-air temperature

single-diode operation (see note 5)

PARAMETER	TEST CONDITIONS	ALL TYPES		UNIT
		MAX		
t_{fr} Forward Recovery Time	$I_F = 500 mA$, See Figure 3	40		ns
t_{rr} Reverse Recovery Time	$I_F = 200 mA$, $I_{RM} = 200 mA$, $i_{rr} = 20 mA$, $R_L = 100 \Omega$, See Figure 4	20		ns

NOTES: 5. Test conditions and limits apply separately to each of the diodes. The diodes not under test are open-circuited during the measurement of these characteristics, except for I_R as shown in figures 1 and 2.

6. See figures 1 and 2, Parameter Measurement Information section.

7. This parameter is measured using pulse techniques. $t_p = 100 \mu s$, duty cycle = 2%. Read time is 90 μs from leading edge of the pulse.

8. The initial instantaneous value is measured using pulse techniques. $t_p = 150 \mu s$, duty cycle $\leq 2\%$, pulse rise time $\leq 10 ns$. The total diode shunt capacitance is 19 pF max and the equipment bandwidth is 80 MHz.

9. Test conditions apply separately to the common-anode and common-cathode sections. Subscript numeral 1 refers to the diode under test; subscript N refers simultaneously to each of the other diodes in the section. Each diode is individually tested after the device reaches operating thermal equilibrium.

† C_T is the total pin-to-pin capacitance measured across any of the diodes. The interaction of the other diodes cannot easily be separated out unless three-terminal guarded measurement techniques are used. The actual capacitance of a single, isolated diode will typically be 30% of the measured pin-to-pin value for the common-cathode diodes, and 75% of the measured value for the common-anode diodes.

TYPES TID29, TID30 EPITAXIAL PLANAR SILICON DUAL 10-DIODE ARRAYS

PARAMETER MEASUREMENT INFORMATION

When measuring the reverse current of an individual diode the current meter must be placed so that the shunt current through the other diodes is bypassed around the meter. To obtain accurate readings, the voltage drop across the current meter must be less than 10 mV.

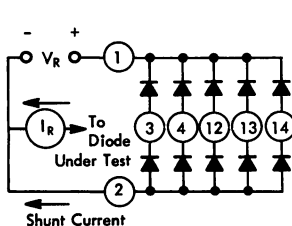

FIGURE 1 — TEST CIRCUIT FOR
COMMON-CATHODE DIODES

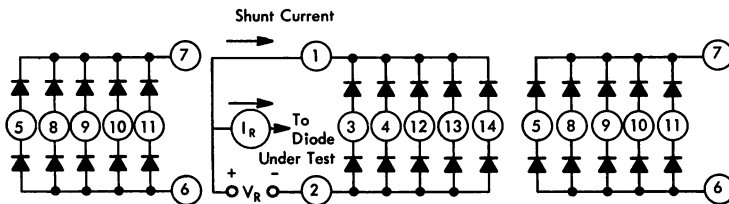
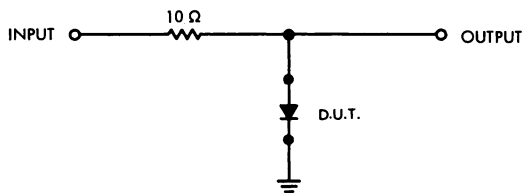
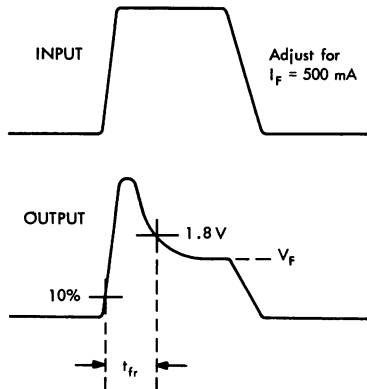

FIGURE 2 — TEST CIRCUIT FOR
COMMON-ANODE DIODES



TEST CIRCUIT



VOLTAGE WAVEFORMS

FIGURE 3 — FORWARD RECOVERY TIME

- NOTES: a. The input pulse is supplied by a generator with the following characteristics: $t_r \leq 15$ ns, $Z_{out} = 50 \Omega$, $t_p = 150$ ns, duty cycle $\leq 2\%$.
b. The output waveform is monitored on an oscilloscope with the following characteristics: $t_r \leq 4.5$ ns, $R_{in} \geq 1$ M Ω , $C_{in} \leq 5$ pF.

TYPES TID29, TID30 EPITAXIAL PLANAR SILICON DUAL 10-DIODE ARRAYS

PARAMETER MEASUREMENT INFORMATION

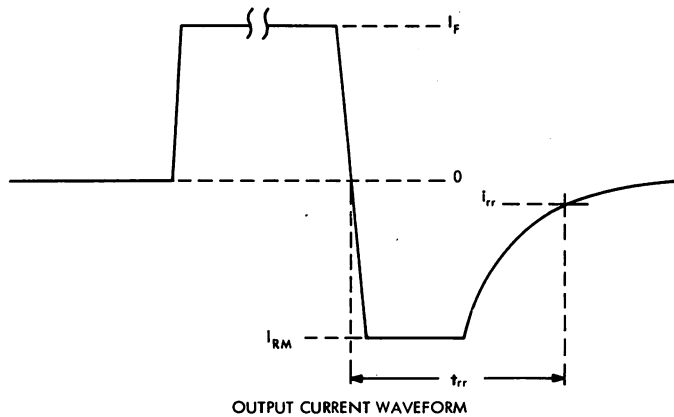
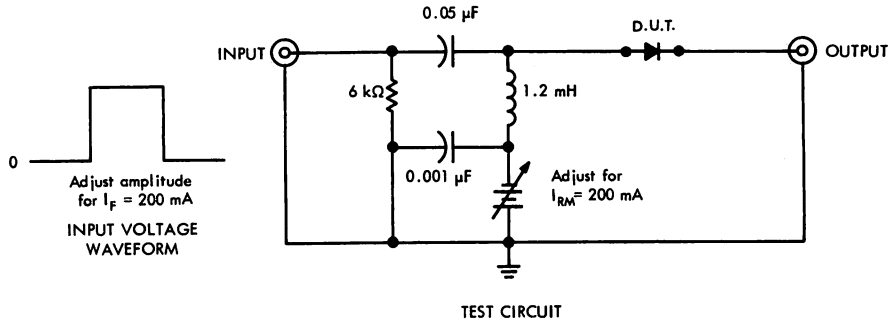

FIGURE 4 — REVERSE RECOVERY TIME

- NOTES: c. The input pulse is supplied by a generator with the following characteristics: $t_f \leq 1$ ns, $Z_{out} = 50 \Omega$, $t_p = 200$ ns, duty cycle $\leq 1\%$.
 d. The output waveform is monitored on an oscilloscope with the following characteristics: $t_r \leq 0.4$ ns, $R_{in} = 50 \Omega$.

TYPES TIV306, TIV307, TIV308 PLANAR SILICON VOLTAGE-VARIABLE-CAPACITANCE DIODES



TYPES TIV306, TIV307, TIV308
BULLETIN NO. DL-5 68/0196, MAY 1968
REPLACES BULLETIN NO. DL-5 67/0196, JUNE 1967

FOR USE IN AUTOMATIC FREQUENCY CONTROL AND VOLTAGE-VARIABLE TUNING

- Small Size, Whiskerless, Double-Plug Construction
- High Q, High Capacitance Ratio
- Replaces TIV300 and TIV301

mechanical data

The glass-passivated silicon wafer is encased in a hermetically sealed glass package. High-temperature bond between wafer and leads ensures integral positive contact under extreme environmental conditions.

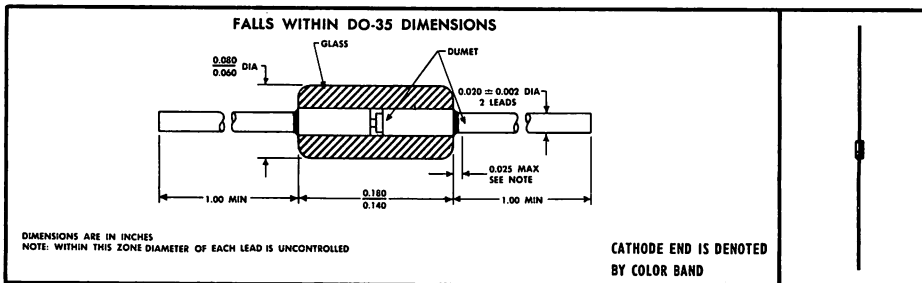

absolute maximum ratings at 25°C free-air temperature (unless otherwise noted)

Peak Reverse Voltage	20 V
Continuous Device Dissipation at (or below) 25°C Free-Air Temperature (See Note 1)	250 mW
Operating Free-Air Temperature Range	-65°C to 150°C
Storage Temperature Range	-65°C to 200°C

electrical characteristics at 25°C free-air temperature

PARAMETER	TEST CONDITIONS	TIV306		TIV307		TIV308		UNIT
		MIN	MAX	MIN	MAX	MIN	MAX	
$V_{(BR)}$ Breakdown Voltage	$I_R = 100 \mu A$	20		20		20		V
I_R Reverse Current	$V_R = 15 V$		50		50		50	nA
C_T Total Capacitance	$V_R = 4 V, f = 1 MHz$	5	9	7	11	9	14	pF
Q Figure of Merit (Note 2)	$V_R = 4 V, f = 50 MHz$	200		200		200		
C_{V1} C_{V2} Capacitance Ratio	$V_1 = 1 V, V_2 = 5 V, f = 1 MHz$	1.5		1.5		1.5		

NOTES: 1. Derate linearly to 150°C free-air temperature at the rate of 2 mW/deg.

2. Figure of Merit, Q, is defined by the equation $Q = \frac{1}{2\pi f r_s C_T}$ where r_s is Equivalent Series Resistance, as measured on a Boonton RF Admittance Bridge, Model 33A or equivalent.

TYPES TIV306, TIV307, TIV308 PLANAR SILICON VOLTAGE-VARIABLE-CAPACITANCE DIODES

TYPICAL APPLICATION DATA

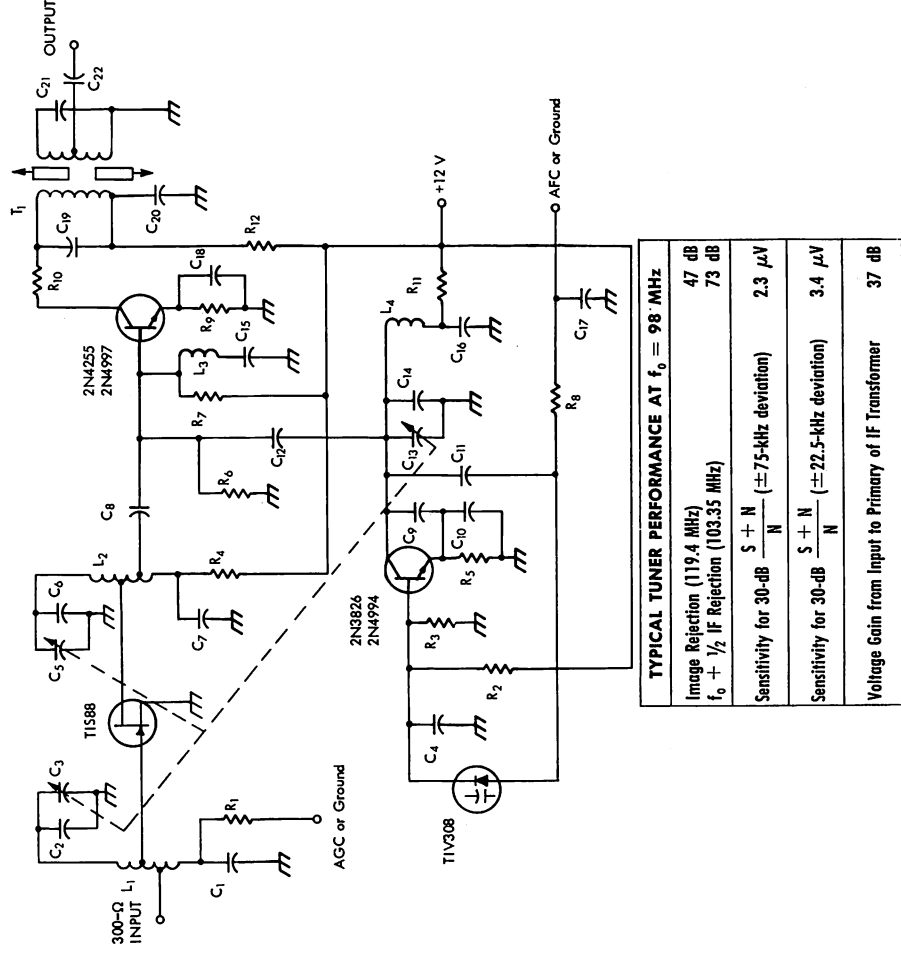

CIRCUIT COMPONENT INFORMATION

CAPACITORS

- C₁: 0.001 μ F
- C₂: 10 pF
- C₃: †
- C₄: 0.001 μ F
- C₅: †
- C₆: 10 pF
- C₇: 0.001 μ F
- C₈: 12 pF
- C₉: 4.7 pF
- C₁₀: 6.8 pF
- C₁₁: 4.7 pF
- C₁₂: 1.2 pF
- C₁₃: †
- C₁₄: 10 pF
- C₁₅: 240 pF
- C₁₆: 0.001 μ F
- C₁₇: 0.1 μ F
- C₁₈: 0.01 μ F
- C₁₉: 47 pF
- C₂₀: 0.01 μ F
- C₂₁: 100 pF
- C₂₂: 0.01 μ F

†Three-gang, 6–21 pF each, with trimmers.

RESISTORS

- R₁: 27 k Ω
 - R₂: 10 k Ω
 - R₃: 2.7 k Ω
 - R₄: 330 Ω
 - R₅: 1 k Ω
 - R₆: 2.7 k Ω
 - R₇: 10 k Ω
 - R₈: 330 k Ω
 - R₉: 820 Ω
 - R₁₀: 120 Ω
 - R₁₁: 330 Ω
 - R₁₂: 330 Ω
- All resistors $1/2$ W, ten percent tolerance

TRANSFORMER

- T₁: 10.7 MHz IF transformer

COILS

- L₁: 2.5 T, #16 bus, $1/4$ " ID, carbonyl "E" core, tapped at 1 T and 2 T from bottom
- L₂: 4 T, #16 bus, $1/4$ " ID, air core, tapped at 1.3 T and 1 T from bottom
- L₃: 1 μ H
- L₄: 3 T, #16 bus, $1/4$ " ID, carbonyl "E" core

FIGURE 19 — TYPICAL FM TUNER



TYPES 1N746 THRU 1N759, 1N746A THRU 1N759A SILICON VOLTAGE REGULATOR DIODES



TYPES 1N746 THRU 1N759, 1N746A THRU 1N759A
BULLETIN NO. DL-5 681008, MARCH 1959
REVISED MAY 1968

3.3 TO 12 VOLTS • 400 mw

GUARANTEED DYNAMIC ZENER IMPEDANCE

Available in 5% and 10% tolerances
-65 to 175°C operation & storage

mechanical data

The diode is encased in a hermetically sealed hard-glass package which falls within the JEDEC DO-7 outline. Unit weight is typically 0.195 gram.

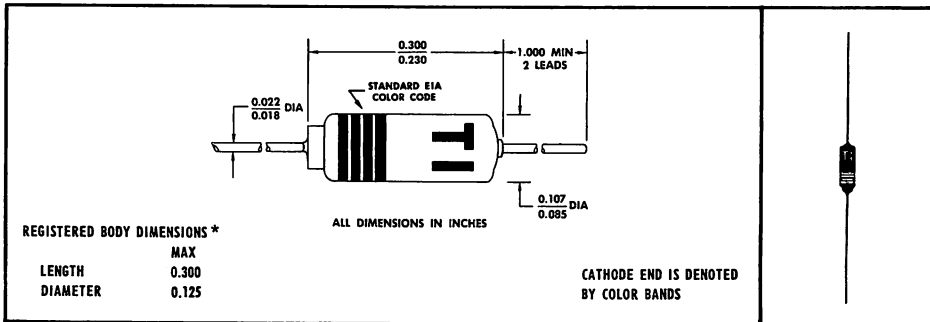

*absolute maximum ratings

Average Rectified Forward Current at (or below) 25°C Free-Air Temperature	230 ma
Average Rectified Forward Current at 150°C Free-Air Temperature	85 ma
Continuous Power Dissipation at (or below) 50°C Free-Air Temperature	400 mw
Continuous Power Dissipation at 150°C Free-Air Temperature	100 mw
Operating Free-Air Temperature Range	-65°C to 175°C
Storage Temperature Range	-65°C to 175°C

*Indicates JEDEC registered data



TYPES 1N746 THRU 1N759, 1N746A THRU 1N759A SILICON VOLTAGE REGULATOR DIODES

*electrical characteristics at 25°C free-air temperature (unless otherwise noted)

PARAMETER	V_Z Zener Breakdown Voltage				α_Z Temperature Coefficient of Breakdown Voltage	Z_Z Small- Signal Breakdown Impedance	I_R Static Reverse Current		
	$I_{ZT} = 20 \text{ ma}$						$I_{ZT} = 20 \text{ ma}$	$I_{ZT} = 20 \text{ ma},$ $I_{ZT} = 1 \text{ ma}$	$V_R = 1 \text{ v}$
LIMIT →	NOM	1N746-1N759 MIN MAX		1N746A-1N759A MIN MAX		TYP	MAX	MAX	MAX
UNIT →	v	v	v	v	v	% / °C	Ω	μa	μa
1N746	3.3	2.97	3.63	3.135	3.465	-0.062	28	10	30
1N747	3.6	3.24	3.96	3.420	3.780	-0.055	24	10	30
1N748	3.9	3.51	4.29	3.705	4.095	-0.049	23	10	30
1N749	4.3	3.87	4.73	4.085	4.515	-0.036	22	2	30
1N750	4.7	4.23	5.17	4.465	4.935	-0.018	19	2	30
1N751	5.1	4.59	5.61	4.845	5.355	-0.008	17	1	20
1N752	5.6	5.04	6.16	5.320	5.880	+0.006	11	1	20
1N753	6.2	5.58	6.82	5.890	6.510	+0.022	7	0.1	20
1N754	6.8	6.12	7.48	6.460	7.140	+0.035	5	0.1	20
1N755	7.5	6.75	8.25	7.125	7.875	+0.045	6	0.1	20
1N756	8.2	7.38	9.02	7.790	8.610	+0.052	8	0.1	20
1N757	9.1	8.19	10.01	8.645	9.555	+0.056	10	0.1	20
1N758	10.0	9.00	11.00	9.500	10.500	+0.060	17	0.1	20
1N759	12.0	10.80	13.20	11.400	12.600	+0.060	30	0.1	20

*Indicates JEDEC registered data

MAXIMUM POWER DISSIPATION

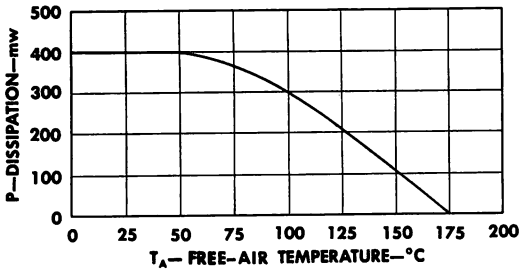

TYPICAL DYNAMIC IMPEDANCE vs ZENER VOLTAGE

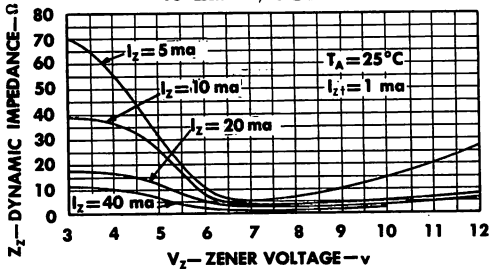

TYPICAL ZENER TEMPERATURE COEFFICIENT vs ZENER VOLTAGE

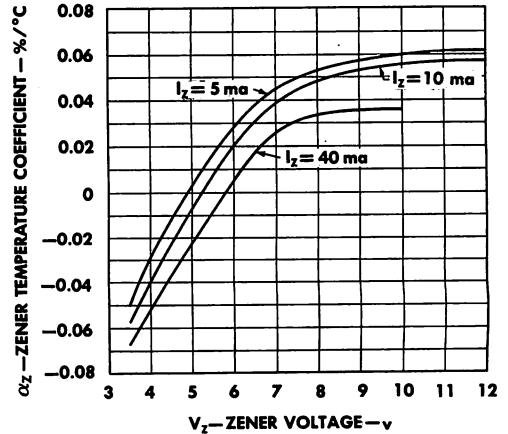

TYPES 1N746 THRU 1N759, 1N746A THRU 1N759A SILICON VOLTAGE REGULATOR DIODES

**ZENER SURGE CURRENT
SINGLE SURGE—NON REPETITIVE**

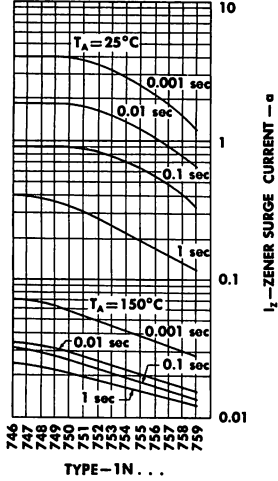

ZENER RECURRENT SURGE

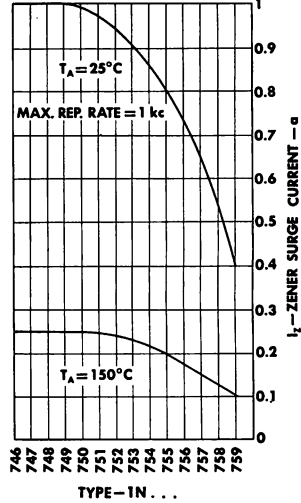

**FORWARD SURGE CURRENT
SINGLE SURGE—NONREPETITIVE
TYPE 1N746—1N759**

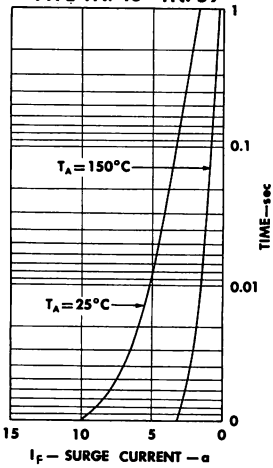

TYPICAL CAPACITANCE

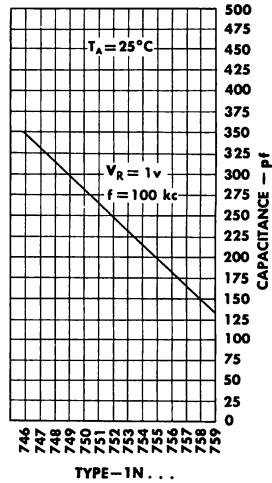

TYPES 1N746 THRU 1N759, 1N746A THRU 1N759A SILICON VOLTAGE REGULATOR DIODES

TYPICAL CHARACTERISTICS

V_z vs I_z TYPE 1N746

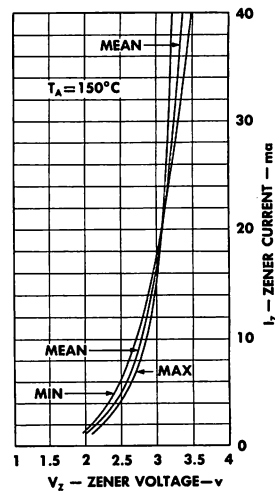
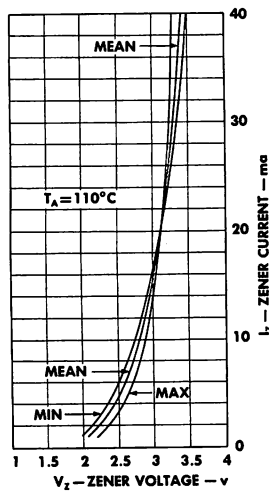
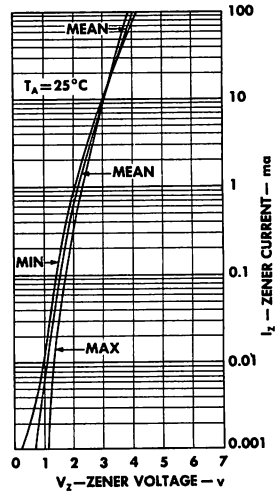
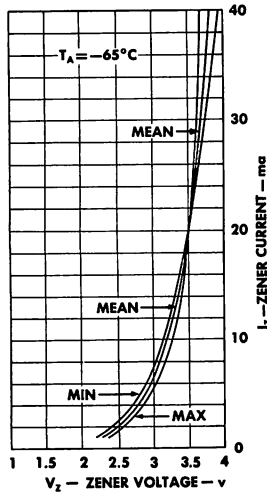

An individual diode will have voltage characteristics which vary with reverse current as shown on all curves.

When a diode has a zener voltage at 20 ma different from the value shown, translate the curves to this new value or shift the voltage axis to correspond to the translation. The max-min curves will now give the individual diode zener voltage spread at different current levels.

TYPES 1N746 THRU 1N759, 1N746A THRU 1N759A SILICON VOLTAGE REGULATOR DIODES

TYPICAL CHARACTERISTICS

V_Z vs I_Z TYPE 1N751

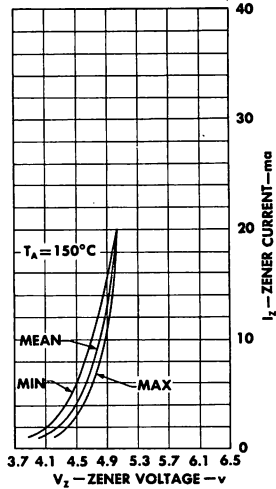
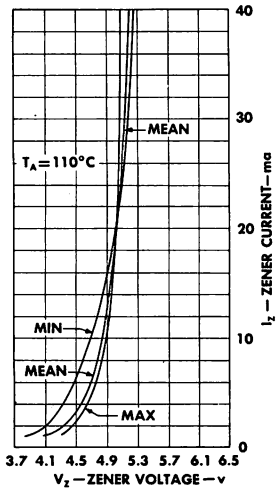
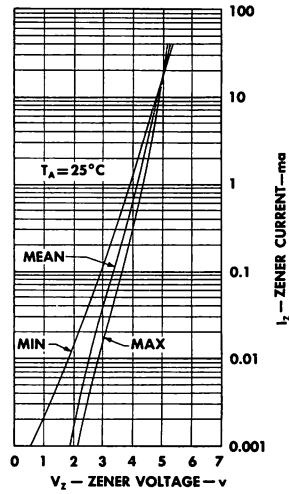
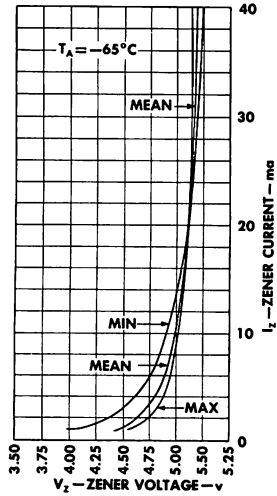

An individual diode will have voltage characteristics which vary with reverse current as shown on all curves.

When a diode has a zener voltage at 20 ma different from the value shown, translate the curves to this new value or shift the voltage axis to correspond to the translation. The max-min curves will now give the individual diode zener voltage spread at different current levels.

TYPES 1N746 THRU 1N759, 1N746A THRU 1N759A SILICON VOLTAGE REGULATOR DIODES

TYPICAL CHARACTERISTICS

V_Z vs I_Z TYPE 1N752

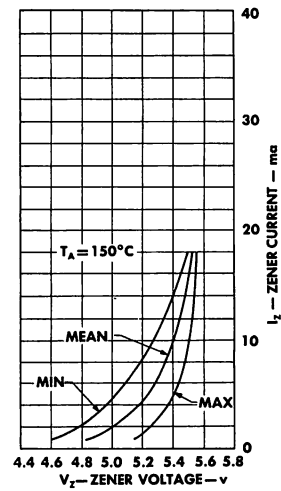
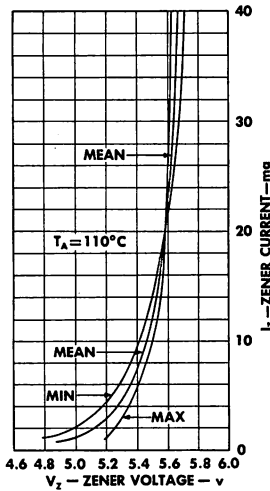
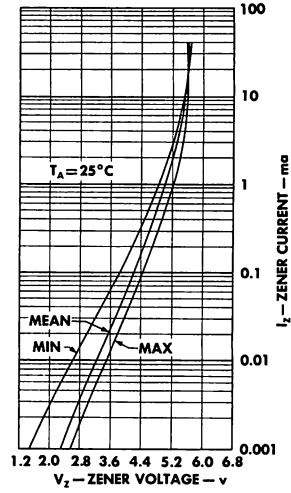
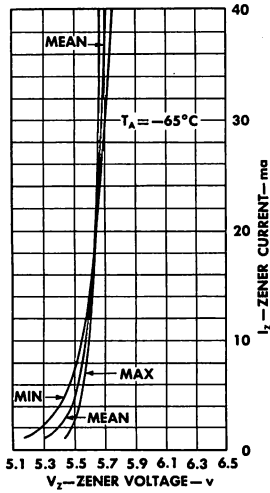

An individual diode will have voltage characteristics which vary with reverse current as shown on all curves.

When a diode has a zener voltage at 20 ma different from the value shown, translate the curves to this new value or shift the voltage axis to correspond to the translation. The max-min curves will now give the individual diode zener voltage spread at different current levels.

TYPES 1N746 THRU 1N759, 1N746A THRU 1N759A SILICON VOLTAGE REGULATOR DIODES

TYPICAL CHARACTERISTICS

V_z vs I_z TYPE 1N754

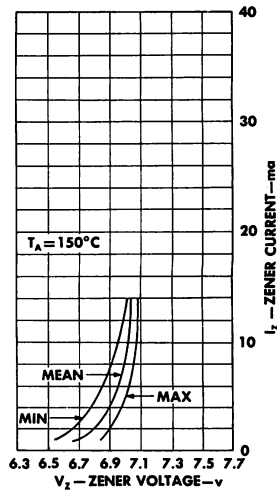
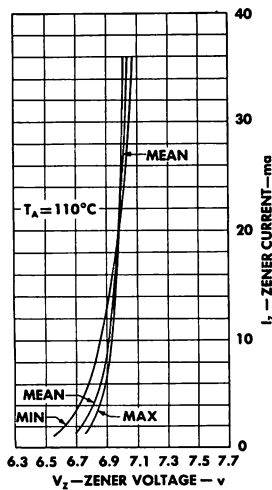
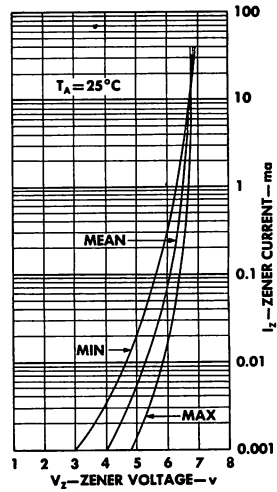
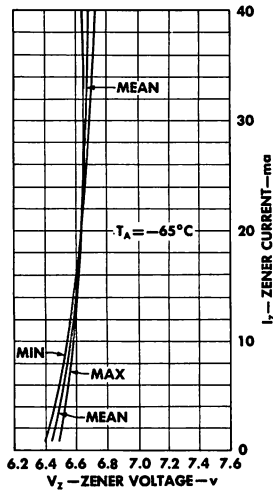

An individual diode will have voltage characteristics which vary with reverse current as shown on all curves.

When a diode has a zener voltage at 20 ma different from the value shown, translate the curves to this new value or shift the voltage axis to correspond to the translation. The max-min curves will now give the individual diode zener voltage spread at different current levels.

TYPES 1N746 THRU 1N759, 1N746A THRU 1N759A SILICON VOLTAGE REGULATOR DIODES

TYPICAL CHARACTERISTICS

V_Z vs I_Z TYPE 1N759

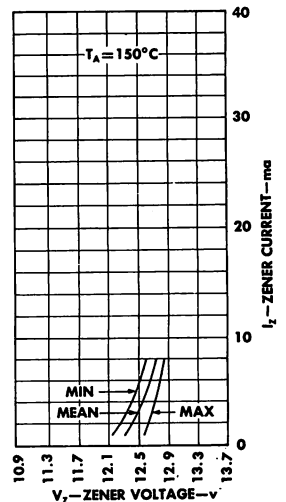
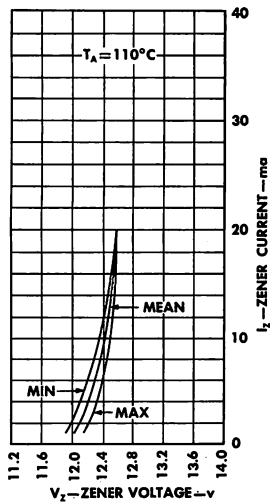
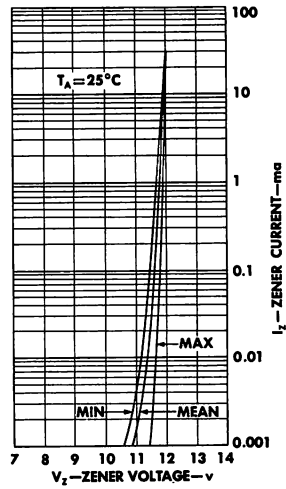
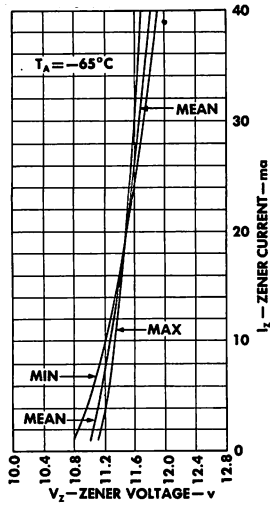

An individual diode will have voltage characteristics which vary with reverse current as shown on all curves.

When a diode has a zener voltage at 20 ma different from the value shown, translate the curves to this new value or shift the voltage axis to correspond to the translation. The max-min curves will now give the individual diode zener voltage spread at different current levels.



400 mW — 2.4 V to 3 V

**1N4370A Thru 1N4372A Can Be Supplied in Accordance with MIL-S-19500/127
Low Noise Density: 20 $\mu\text{V}/\sqrt{\text{Hz}}$ Typical
Very Low Dynamic Zener Impedance**

mechanical data

The diode is encased in a hermetically sealed hard-glass package. The outline drawing meets JEDEC DO-7 outline*. Unit weight is 0.195 gram.

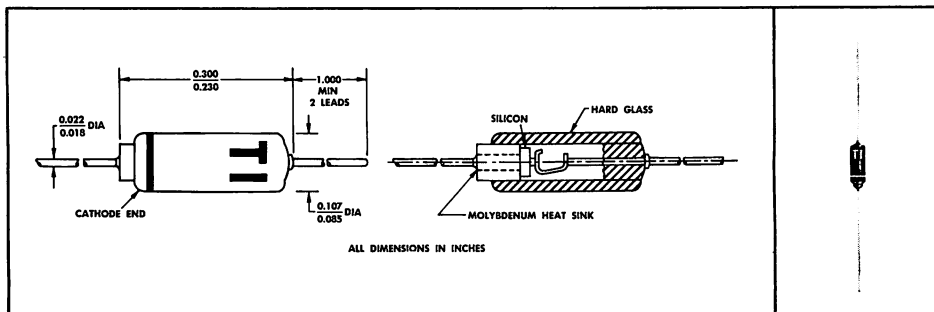

*** absolute maximum ratings at 25°C free-air temperature (unless otherwise noted)**

TYPE	I _{ZM} Steady-State Reverse Current (See Note 1)	P Dissipation T _A ≤ 50°C (See Note 2)	T _{stg} Storage Temperature Range	Lead Temperature (See Note 3)
1N4370	150 mA	400 mW	-55°C to 175°C	230°C
1N4370A				
1N4371	135 mA			
1N4371A				
1N4372				
1N4372A	120 mA			

NOTES: 1. The nominal I_{ZM} currents shown are applicable to devices having regulator voltages 10% above the nominal V_Z values. These values do not represent absolute limits. The actual steady-state current-voltage product must not exceed 400 mW.

2. Derate linearly to 175°C free-air temperature at the rate of 3.2 mW/deg.

3. This value applies 1/16 inch from the case for 10 seconds.

*Indicates JEDEC registered data.

TYPES 1N4370 THRU 1N4372, 1N4370A THRU 1N4372A
BULLETIN NO. DL-S 668111, JANUARY 1966

TYPES 1N4370 THRU 1N4372, 1N4370A THRU 1N4372A ALLOY-JUNCTION SILICON VOLTAGE REGULATOR DIODES

*electrical characteristics at 25°C free-air temperature

PARAMETER	V_Z Zener Breakdown Voltage			Z_Z Small-Signal Breakdown Impedance	I_R Static Reverse Current	V_F Static Forward Voltage
TEST CONDITIONS	$I_{ZT} = 20 \text{ mA}$ (See Note 4)			$I_{ZT} = 20 \text{ mA}$ $I_{z1} = 2 \text{ mA}$ $f = 60 \text{ Hz}$	$V_R = 1 \text{ V}$	$I_F = 200 \text{ mA}$
LIMIT	MIN	NOM†	MAX	MAX	MAX	MAX
UNIT	V			Ω	μA	V
1N4370	2.16	2.4	2.64	30	100	1.5
1N4370A	2.28	2.4	2.52	30	100	1.5
1N4371	2.43	2.7	2.97	30	75	1.5
1N4371A	2.57	2.7	2.84	30	75	1.5
1N4372	2.70	3	3.30	29	50	1.5
1N4372A	2.85	3	3.15	29	50	1.5

NOTE 4: This parameter is measured after the device reaches operating thermal equilibrium.

*Indicates JEDEC registered data.

†Tolerance is $\pm 10\%$ for the 1N4370 thru 1N4372 series; $\pm 5\%$ for the 1N4370A thru 1N4372A series.

PARAMETER MEASUREMENT INFORMATION

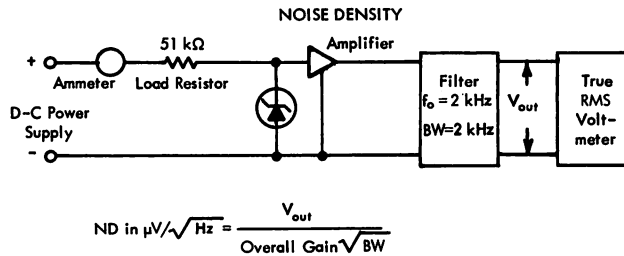

FIGURE 1 — NOISE DENSITY TEST CIRCUIT

STANDARD MOUNTING HARDWARE FOR SILICON THYRISTORS



STANDARD MOUNTING HARDWARE FOR
SILICON THYRISTORS
BULLETIN NO. DLS-688866, MAY 1968

This data sheet identifies those standard hardware kits which are supplied with each device. At additional cost, nonstandard hardware items will be supplied.

The mounting hardware assembly drawings of Section A (Figures 1 and 2) specify the individual hardware items that are included in each mounting hardware kit. Section A also references the package outlines for which each kit is designed and shows the typical thermal resistance associated with the mounting hardware.

Section B contains mechanical drawings of the individual hardware items that are referenced in Figures 1 and 2.

TABLE A
SILICON THYRISTORS

DEVICE TYPES	KIT
TIC20-TIC21	*
TIC22-TIC23	10
TI40A0-TI40A4	9
TIC44-TIC47	*
TI145A0-TI145A4	*
2N681,A-2N689,A	10
2N876-2N881	*
2N884-2N889	*
2N1595-2N1599	*
2N1600-2N1604	9
2N1770,A-2N1777,A	9
2N1778	9
2N1842B-2N1850B	10
2N2322-2N2326	*
2N2653	9
2N2687-2N2690	*
2N3001-2N3004	*
2N3005-2N3008	*
TI3037-TI3042	10
2N3555-2N3558	*
2N3559-2N3562	*
2N3936-2N3940	9
2N5273-2N5275	10

*No hardware furnished with these devices.

Texas Instruments reserves the right to substitute similar parts at any time in order to expedite delivery or improve design.



STANDARD MOUNTING HARDWARE FOR SILICON THYRISTORS

SECTION A — MOUNTING HARDWARE ASSEMBLY DRAWINGS AND PHOTOGRAPHS

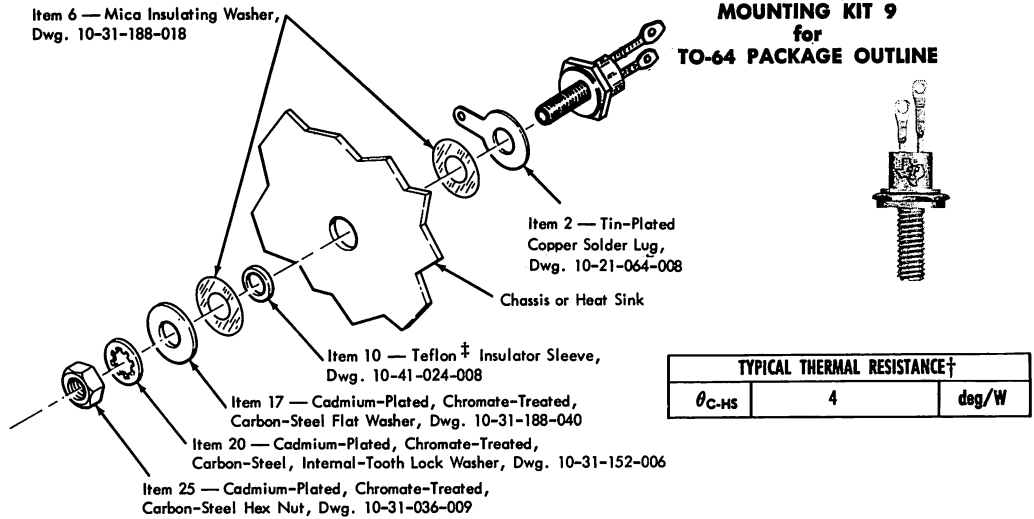

FIGURE 1

**MOUNTING KIT 10
for
TO-48 PACKAGE OUTLINE**

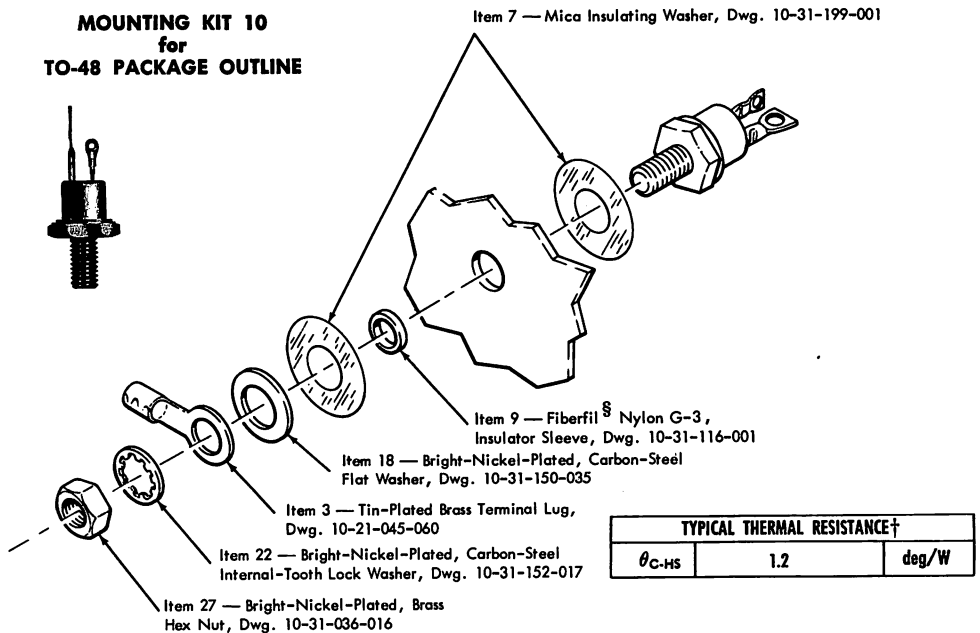

FIGURE 2

† θ_{C-HS} is the thermal resistance from the mounting base of the semiconductor-device case to the mounting surface of the heat sink. The heat sink used to determine this value was a smooth, flat, copper plate, with the thermocouple mounted 0.05 inch below the mounting surface in an area beneath the device. The device was mounted directly to a clean, dry, heat-sink surface, without the use of a thermal compound and a torque of ten inch-pounds was applied to the stud or each of the mounting screws.

‡Trademark of E. I. du Pont

§Trademark of Cedar Plastics

STANDARD MOUNTING HARDWARE FOR SILICON THYRISTORS

SECTION B — MECHANICAL DRAWINGS OF HARDWARE ITEMS

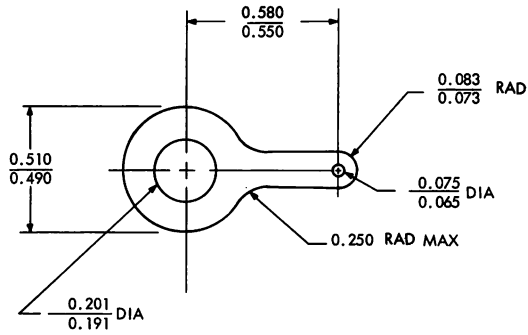

SOLDER LUG
Item 2

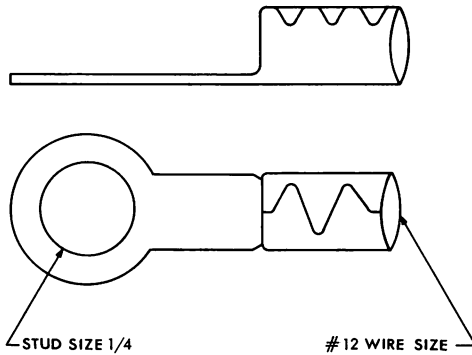

TERMINAL LUG
Item 3

STANDARD MOUNTING HARDWARE FOR SILICON THYRISTORS

SECTION B — MECHANICAL DRAWINGS OF HARDWARE ITEMS

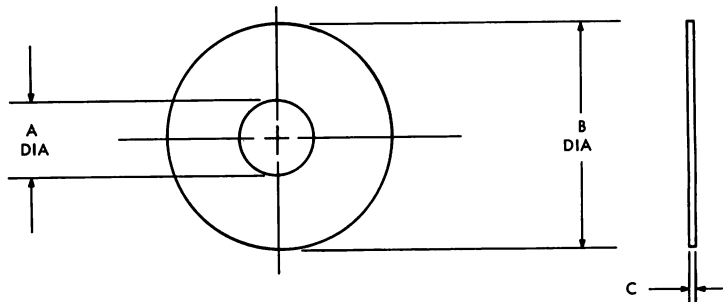

Item	A	B	C
6	0.205	0.536	0.005
	0.195	0.526	0.001
7	0.270	0.885	0.0025
	0.260	0.865	0.0015

INSULATING WASHER
Items 6 and 7

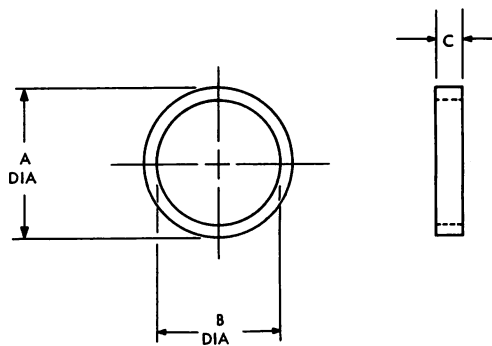

Item	A	B	C
9	0.340	0.270	0.072
	0.330	0.260	0.052
10	0.271	0.203	0.050
	0.251	0.191	0.035

INSULATING SLEEVE
Items 9 and 10

STANDARD MOUNTING HARDWARE FOR SILICON THYRISTORS

SECTION B — MECHANICAL DRAWINGS OF HARDWARE ITEMS

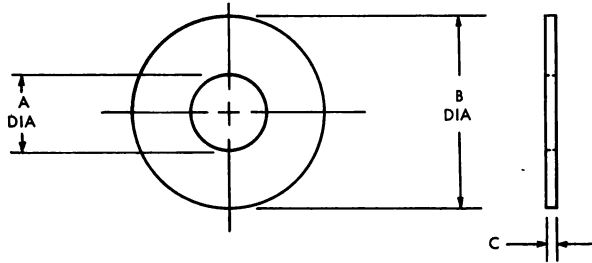

Item	A	B	C
17	0.208	0.505	0.051
	0.198	0.495	0.041
18	0.276	0.635	0.069
	0.255	0.615	0.034

FLAT WASHER
Items 17 and 18

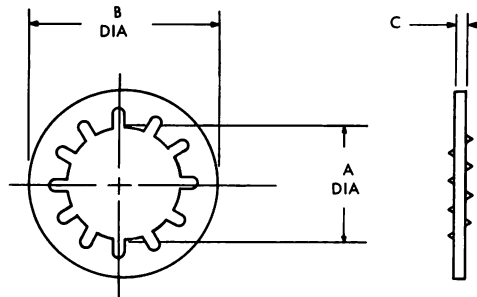

Item	A	B	C
20	0.204	0.381	0.025
	0.195	0.365	0.020
22	0.267	0.478	0.027
	0.256	0.466	0.023

INTERNAL-TOOTH LOCK WASHER
Items 20 and 22

STANDARD MOUNTING HARDWARE FOR SILICON THYRISTORS

SECTION B — MECHANICAL DRAWINGS OF HARDWARE ITEMS

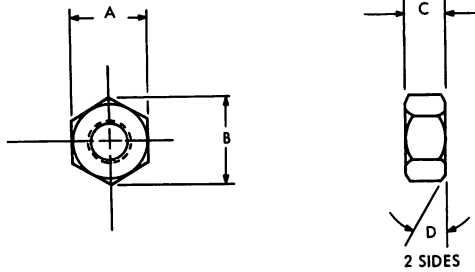

Item	Thread	A	B	C	D
25	10-32	0.375	0.433	0.130	30°
	UNF-2B	0.362	0.413	0.117	
27	1/4-28	0.438	0.506	0.193	30°
	UNF-2B	0.423	0.488	0.178	

HEXAGONAL NUT
Items 25 and 27

TYPES TIC20, TIC21, TIC22, TIC23 SILICON BIDIRECTIONAL TRIODE THYRISTORS



TYPES TIC20, TIC21, TIC22, TIC23
BULLETIN NO. DL-5 657400, MARCH 1965

GATED SYMMETRICAL SWITCHES 200 and 300 VOLTS — 6 AMPS

description

The TIC20 through TIC23 are bidirectional triode semiconductor switches which may be triggered from the blocking state to the conducting state by either polarity of gate signal with either polarity of anode-2 voltage.

mechanical data

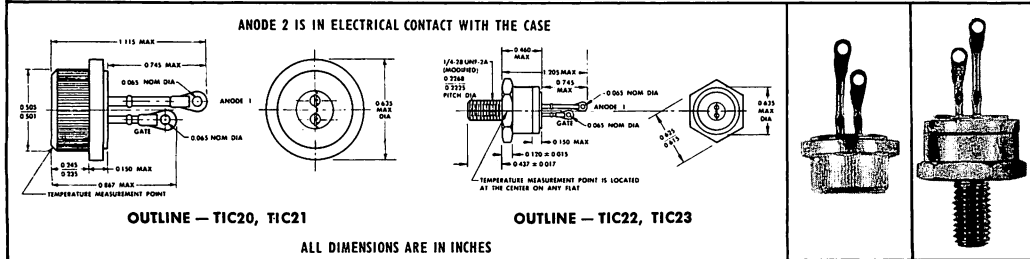

absolute maximum ratings over operating case temperature range (unless otherwise noted)

	TIC20 TIC22	TIC21 TIC23	UNIT
Peak Blocking Voltage (See Note 1)	200	300	v
Full-Cycle RMS Anode Current at (or below) 75°C Case Temperature (See Note 2)	6		a
Peak Anode Surge Current (See Note 3)	50		a
Average Gate Power Dissipation	0.5		w
Peak Gate Power Dissipation for 5 msec	5		w
Operating Case Temperature Range	-25 to +100		°C
Storage Temperature Range	-25 to +100		°C
Terminal Temperature 1/8 Inch from Case for 10 Seconds	230		°C

electrical characteristics at 25°C case temperature (unless otherwise noted)

PARAMETER	TEST CONDITIONS	TYPE	TYP	MAX	UNIT
I_{AOM} Peak Anode Blocking Current	$V_{AAM} = 200$ v, $I_G = 0$, $T_C = 100^\circ\text{C}$	TIC20 TIC22		1	ma
	$V_{AAM} = 300$ v, $I_G = 0$, $T_C = 100^\circ\text{C}$	TIC21 TIC23			
I_{GT} Gate Trigger Current	$V_{A2-A1} = +12$ v, $R_L = 12 \Omega$, $PW_G \geq 20 \mu\text{sec}$	ALL		+50	ma
	$V_{A2-A1} = +12$ v, $R_L = 12 \Omega$, $PW_G \geq 20 \mu\text{sec}$	ALL		-50	
	$V_{A2-A1} = -12$ v, $R_L = 12 \Omega$, $PW_G \geq 20 \mu\text{sec}$	ALL	+100		
	$V_{A2-A1} = -12$ v, $R_L = 12 \Omega$, $PW_G \geq 20 \mu\text{sec}$	ALL		-50	
V_{GT} Gate Trigger Voltage	$V_{A2-A1} = +12$ v, $R_L = 12 \Omega$, $PW_G \geq 20 \mu\text{sec}$	ALL		+3	v
	$V_{A2-A1} = +12$ v, $R_L = 12 \Omega$, $PW_G \geq 20 \mu\text{sec}$	ALL		-3	
	$V_{A2-A1} = -12$ v, $R_L = 12 \Omega$, $PW_G \geq 20 \mu\text{sec}$	ALL	+3		
V_{AAM} Peak "On" Voltage	$I_{A2M} = \pm 10$ a, See Note 4	ALL		1.9	v

- NOTES: 1. These values apply bidirectionally when the gate-anode-1 resistance $R_{GA1} \leq \infty$.
 2. This value applies for 60-cps full-sine-wave operation with resistive load. Above 75°C derate according to Figure 3.
 3. This value applies for one 60-cps full sine wave when the device is operating at (or below) the rated value of anode current. Surge may be repeated after the device has returned to original thermal equilibrium.
 4. The initial instantaneous value is measured using pulse techniques. Anode-pulse width = 300 μsec , Duty Cycle $\leq 1\%$.



TEXAS INSTRUMENTS
INCORPORATED
POST OFFICE BOX 5012 • DALLAS, TEXAS 75222

TYPES TIC20, TIC21, TIC22, TIC23

SILICON BIDIRECTIONAL TRIODE THYRISTORS

TYPICAL APPLICATION DATA

The two power terminals are designated as Anode 1 (A1) and Anode 2 (A2).
The gate signal is referenced to Anode 1, see Figure 1.

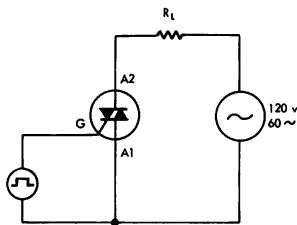

FIGURE 1

TYPICAL ANODE
VOLTAGE-CURRENT CHARACTERISTICS

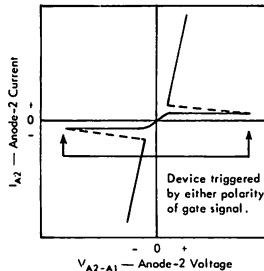

FIGURE 2

LETTER SYMBOLS

Standard symbology has not as yet been developed for bidirectional thyristors. The following tentative list has been compiled by Texas Instruments.

I_{A0M} , I_{ARM} , I_{ASM} , I_{AXM} — The peak value of anode blocking current with the gate terminal returned to the anode-1 terminal through a resistance R_{GA1} or bias network as indicated by the second subscript. "O" indicates $R_{GA1} = \infty$ (gate open-circuited). "R" indicates R_{GA1} = a finite specified value. "S" indicates $R_{GA1} = 0$ (gate short-circuited to anode-1). "X" indicates a bias which may be expressed as $V_{GG} =$ a finite specified value in series with $R_{GA1} =$ a finite specified value. The third subscript, "M" for peak value, may be replaced by "rms" to indicate total rms value.

I_{A2-A10} , I_{A2-A1R} — The steady-state current into the anode-2 terminal when it has positive polarity with respect to the anode-1 terminal and the device is blocking. Reversed polarity is indicated by a negative value of current. The final subscript indicates the gate-to-anode-1 termination as explained above.

I_{A1M} , I_{A2M} , I_{GM} — The peak value of current into the anode-1, anode-2, or gate terminal as indicated by the first letter or letter-numeral subscript.

PW_G — The width of the gate pulse.

I_{A1} , I_{A2} , I_G — The steady-state current into the terminal indicated by the subscript.

V_{AAM} — The peak value of anode-to-anode voltage. Numerals may be added to the "A" subscripts if desirable to indicate relative anode polarity.

V_{A2-A1} — Steady-state anode-2 voltage with respect to anode 1.

THERMAL INFORMATION

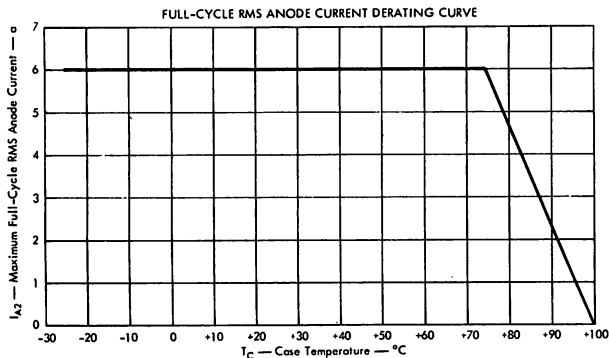

FIGURE 3

TYPES TI42A, TI43A, TIC54, TIC55, TIC56, TIC57 N-P-N DIFFUSED SILICON BREAKDOWN DIODES



TYPES TI42A, TI43A, TIC54, TIC55, TIC56, TIC57
BULLETIN NO. DI-S-68106486, MAY 1968
REPLACES BULLETIN NO. DI-S-622111, MARCH 1962 AND
BULLETIN NO. 622644, MAY 1962

AVALANCHE SWITCHING DEVICES USED FOR FIRING SCRs AND TRIACS

description

Types TI42A, TIC54, and TIC55 guarantee the stated values of breakdown and breakback voltages only when the marked end is negative with respect to the unmarked end.

Types TI43A, TIC56, and TIC57 are electrically symmetrical trigger diacs that have guaranteed breakdown voltage and negative resistance characteristics in both directions. The breakdown voltage in either direction is guaranteed to be within two volts of the breakdown voltage in the other direction.

mechanical data

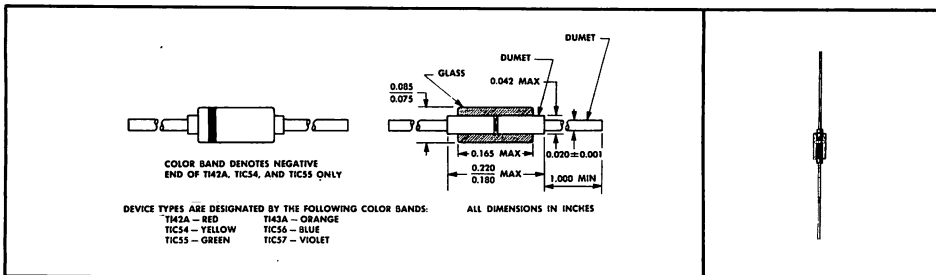

absolute maximum ratings at 100°C free-air temperature (unless otherwise noted)

Average Power Dissipation (See Note 1)	100 mW
Nonrepetitive Peak Current for 10 μ s	1 A
Storage Temperature Range	-65°C to 150°C

electrical characteristics at 25°C free-air temperature†

PARAMETER	TEST CONDITIONS	TYPE	MIN	MAX	UNIT
$V_{(BR)}$ Breakdown Voltage	$dv/dt = 12$ V/ms, See Figure 1	TI42A	28	36	V
		TIC54	26	38	
		TIC55	22	38	
		TI43A	28	36	
		TIC56	26	38	
$V_{(BR)1} - V_{(BR)2}$ Breakdown Voltage Differential‡	$dv/dt = 12$ V/ms, See Figure 1	TI43A		2	V
		TIC56			
		TIC57			
ΔV Breakback Voltage	$dv/dt = 12$ V/ms, See Figure 1	ALL	8		V

NOTE 1: Derate linearly to 150°C free-air temperature at the rate of 2 mW/deg.

†Breakdown and breakback voltage characteristics apply unilaterally to the TI42A, TIC54, and TIC55; bilaterally to the TI43A, TIC56, and TIC57. See Description.

‡Breakdown Voltage Differential is the difference between the two breakdown voltages measured in the two directions.



TYPES TI42A, TI43A, TIC54, TIC55, TIC56, TIC57

N-P-N DIFFUSED SILICON BREAKDOWN DIODES

PARAMETER MEASUREMENT INFORMATION

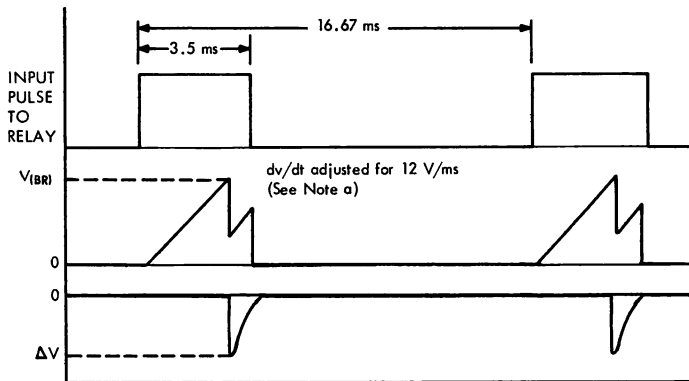
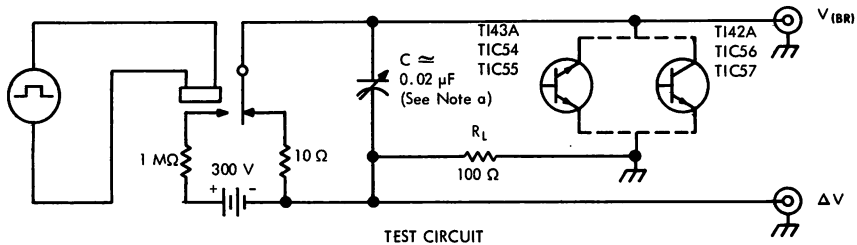

FIGURE 1

NOTE a: Capacitor C is adjusted until dv/dt across DUT is 12 V/ms.

TYPICAL CHARACTERISTICS

It is of special importance to recognize the fact that the breakdown voltage decreases in magnitude as the voltage rate of rise, dv/dt , is increased. This characteristic is illustrated by Figure 2.

BREAKDOWN VOLTAGE
vs
VOLTAGE RATE OF RISE

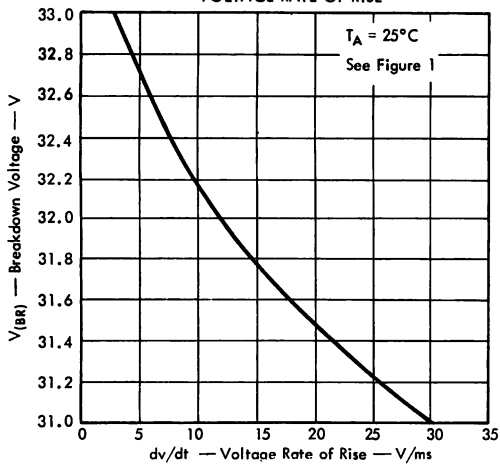

FIGURE 2

BREAKDOWN VOLTAGE
vs
FREE-AIR TEMPERATURE

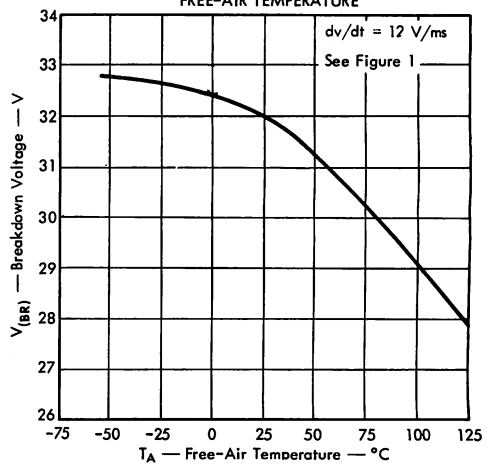

FIGURE 3

TYPES TI42A, TI43A, TIC54, TIC55, TIC56, TIC57 N-P-N DIFFUSED SILICON BREAKDOWN DIODES

TYPICAL APPLICATION DATA

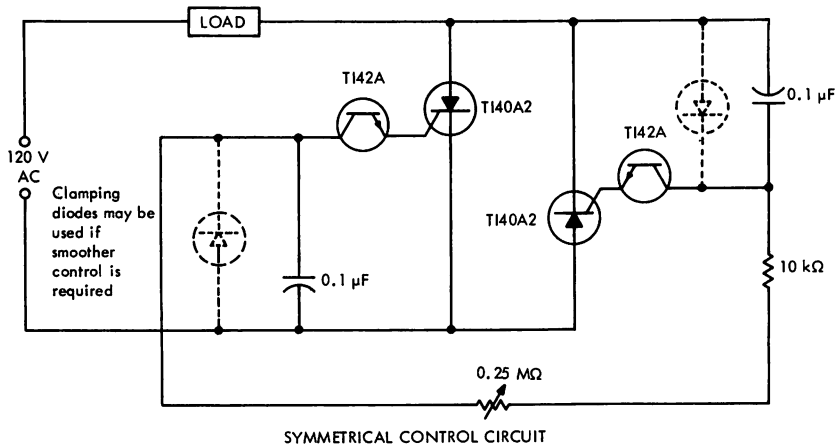

FIGURE 4

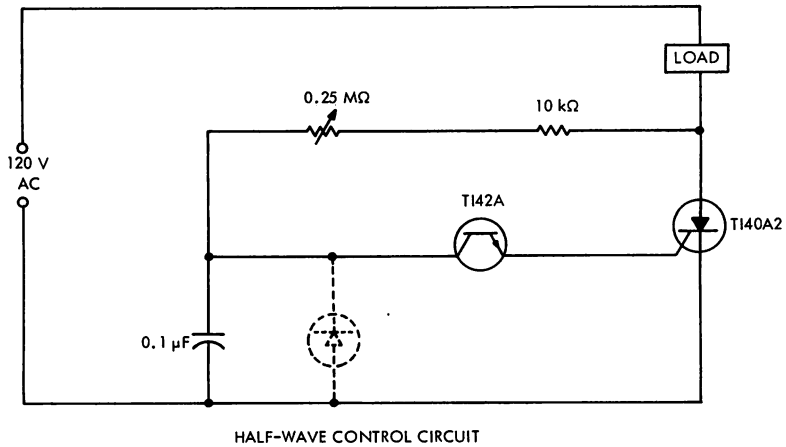

FIGURE 5

TYPES TI42A, TI43A, TIC54, TIC55, TIC56, TIC57 N-P-N DIFFUSED SILICON BREAKDOWN DIODES

TYPICAL APPLICATION DATA

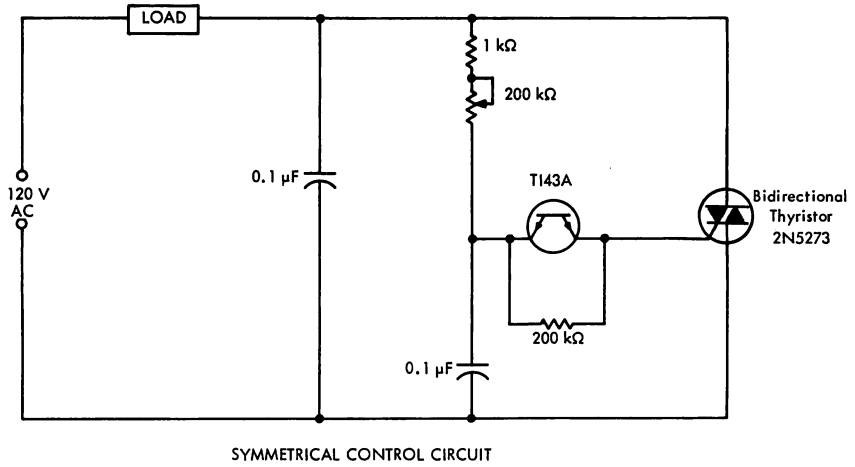

FIGURE 6

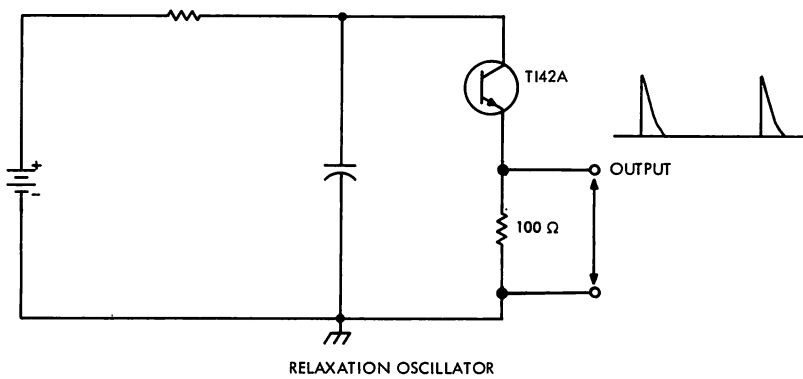

FIGURE 7

TYPES TIC44, TIC45, TIC46, TIC47 P-N-P-N PLANAR SILICON REVERSE-BLOCKING TRIODE THYRISTORS



TYPES TIC44, TIC45, TIC46, TIC47
BULLETIN NO. DLS-669051, SEPTEMBER 1966

SILECT† THYRISTORS

600 mA DC • 30 thru 200 VOLTS

Rugged, One-Piece Construction with Standard TO-18 100-mil Pin Circle

mechanical data

These thyristors are encapsulated in a plastic compound specifically designed for this purpose, using a highly mechanized process developed by Texas Instruments. The case will withstand soldering temperatures without deformation. These devices exhibit stable characteristics under high-humidity conditions and are capable of meeting MIL-STD-202C method 106B. The thyristors are insensitive to light.

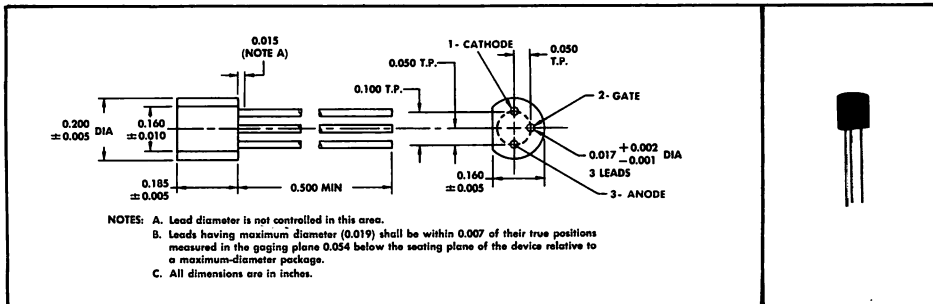

absolute maximum ratings over operating free-air temperature range (unless otherwise noted)

	TIC44	TIC45	TIC46	TIC47	UNIT
Continuous Forward Blocking Voltage, V_{FO} (See Note 1)	30	60	100	200	V
Peak Forward Blocking Voltage (See Note 1)	30	60	100	200	V
Continuous Reverse Blocking Voltage, V_{RO} (See Note 1)	30	60	100	200	V
Peak Reverse Blocking Voltage (See Note 1)	30	60	100	200	V
Continuous Anode Forward Current at (or below) 55°C Case Temperature (See Note 2)	600				mA
Continuous Anode Forward Current at (or below) 25°C Free-Air Temperature (See Note 3)	300				mA
Average Anode Forward Current (180° Conduction Angle) at (or below) 55°C Case Temperature (See Note 4)	430				mA
Peak Anode Surge Current (See Note 5)	6				A
Peak Gate Reverse Voltage	8				V
Peak Gate Forward Current (Pulse Width $\leq 300 \mu\text{s}$)	1				A
Peak Gate Power Dissipation (Pulse Width $\leq 300 \mu\text{s}$)	4				W
Operating Free-Air Temperature Range	-55 to 125				°C
Storage Temperature Range	-55 to 150				°C
Lead Temperature $\frac{1}{16}$ Inch from Case for 10 Seconds	260				°C

- NOTES: 1. These values apply when the gate-cathode resistance $R_{GK} \leq 1 \text{ k}\Omega$.
 2. These values apply for continuous d-c operation with resistive load. Above 55°C derate according to Figure 5.
 3. These values apply for continuous d-c operation with resistive load. Above 25°C derate according to Figure 6.
 4. This value may be applied continuously under single-phase, 60-Hz, half-sine-wave operation with resistive load. Above 55°C derate according to Figure 5.
 5. This value applies for one 60-Hz half sine wave when the device is operating at (or below) rated values of peak reverse blocking voltage and anode forward current. Surge may be repeated after the device has returned to original thermal equilibrium.

†Trademark of Texas Instruments.

TYPES TIC44, TIC45, TIC46, TIC47

P-N-P-N PLANAR SILICON REVERSE-BLOCKING TRIODE THYRISTORS

electrical characteristics at 25°C free-air temperature (unless otherwise noted)

PARAMETER		TEST CONDITIONS	MIN	MAX	UNIT
I_{FR}	Static Anode Forward Blocking Current	$V_F = \text{Rated } V_{FR}, R_{GK} = 1 \text{ k}\Omega, T_A = 125^\circ\text{C}$		50	μA
I_{RR}	Static Anode Reverse Blocking Current	$V_R = \text{Rated } V_{RR}, R_{GK} = 1 \text{ k}\Omega, T_A = 125^\circ\text{C}$		50	μA
I_{GT}	Gate Trigger Current (See Note 6)	$V_{AA} = 6 \text{ V}, R_L = 100 \Omega, t_{p(g)} \geq 20 \mu\text{s}$		200	μA
V_{GT}	Gate Trigger Voltage (See Note 6)	$V_{AA} = 6 \text{ V}, R_L = 100 \Omega, t_{p(g)} \geq 20 \mu\text{s}$		0.8	V
		$V_{AA} = 6 \text{ V}, R_L = 100 \Omega, t_{p(g)} \geq 20 \mu\text{s}, T_A = 125^\circ\text{C}$	0.2		
I_{HR}	Holding Current	$R_L = 100 \Omega, R_{GK} = 1 \text{ k}\Omega$		5	mA
V_F	Static Forward Voltage	$I_F = 300 \text{ mA}, R_{GK} \geq 1 \text{ k}\Omega, \text{ See Note 7}$		1.4	V

NOTES: 6. When measuring these parameters, a 1 k Ω resistor should be used between gate and cathode to prevent triggering by random noise.

7. This parameter is measured using pulse techniques. $t_p = 1 \text{ ms}$, duty cycle $\leq 1\%$.

thermal characteristics

PARAMETER		MAX	UNIT
θ_{J-C}	Junction-to-Case Thermal Resistance	75	deg/W
θ_{J-A}	Junction-to-Free-Air Thermal Resistance	275	

switching characteristics at 25°C free-air temperature

PARAMETER		TEST CONDITIONS	TYP	UNIT
t_{on}	Turn-On Time	$V_{AA} = 30 \text{ V}, R_L = 50 \Omega, R_G = 20 \text{ k}\Omega,$ $V_{in} = 20 \text{ V}, \text{ See Figure 1}$	3.5	μs
t_{off}	Commutating Turn-Off Time	$V_{AA} = 30 \text{ V}, R_L = 50 \Omega, I_R = 1 \text{ A},$ See Figure 2	6.8	μs

TYPES TIC44, TIC45, TIC46, TIC47 P-N-P-N PLANAR SILICON REVERSE-BLOCKING TRIODE THYRISTORS

PARAMETER MEASUREMENT INFORMATION

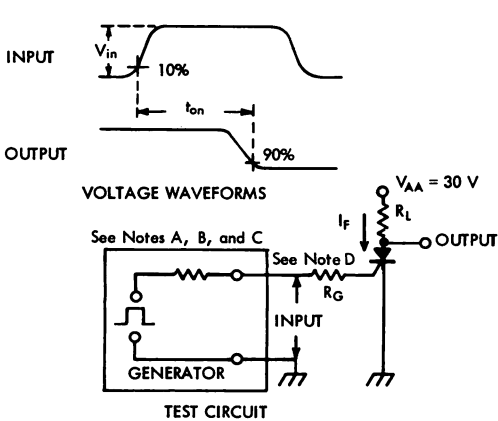

FIGURE 1 — TURN-ON TIME

- NOTES: A. V_{in} is measured with gate and cathode terminals connected as shown and anode terminal open.
- B. The input waveform of Figure 1 has the following characteristics: $t_r \leq 40$ ns, $t_p \geq 20$ μ s.
- C. Waveforms are monitored on an oscilloscope with the following characteristics: $t_r \leq 14$ ns, $R_{in} \geq 10$ M Ω , $C_{in} \leq 12$ pF.
- D. R_G includes the total resistance of the generator and the external resistor.

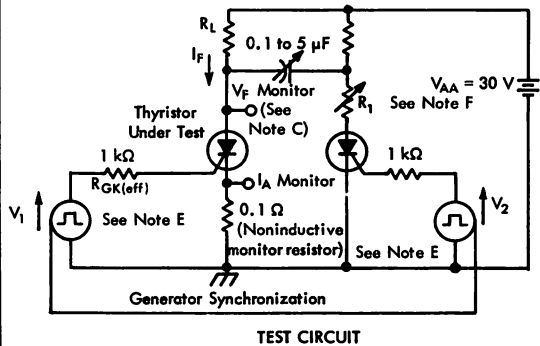
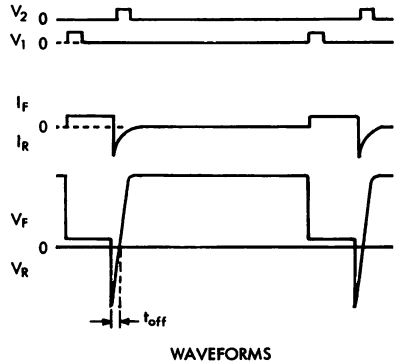

FIGURE 2 — COMMUTATING TURN-OFF TIME

- NOTES: E. Pulse generators for V_1 and V_2 are synchronized to provide an anode current waveform with the following characteristics: $t_p = 50$ to 300 μ s, duty cycle = 1%. The pulse widths of V_1 and V_2 are ≥ 10 μ s.
- F. Resistor R_1 is adjusted for $I_R = 1$ A.

TYPES TIC44, TIC45, TIC46, TIC47

P-N-P-N PLANAR SILICON REVERSE-BLOCKING TRIODE THYRISTORS

THERMAL INFORMATION

The minimum heat-sink requirements may be calculated for any anode-current, heat-sink combination by the following procedure:

1. Determine worst-case power dissipation from figure 3.
2. Calculate maximum allowable case-to-free-air thermal resistance by use of the equation:

$$\theta_{C-A} = \frac{T_J - T_A}{P_{A(av)}} - \theta_{J-C}$$

where: T_J = Junction temperature
 T_A = Free-air temperature
 $P_{A(av)}$ = Average anode power dissipation (see figure 3 for worst-case values)
 θ_{J-C} = Junction-to-case thermal resistance = 75 deg/W maximum.

3. Determine area of heat sink from figure 4.

EXAMPLE

Determine: Minimum size of 1/16"-thick aluminum heat sink for safe operation of thyristor at an average current of 0.4 A with a conduction angle of 180°.

Given: Maximum $T_J = 125^\circ\text{C}$
 $T_A = 35^\circ\text{C}$
 $\theta_{J-C} = 75 \text{ deg/W}$

Solution: From figure 3, $P_{A(av)} = 0.84 \text{ W}$ for 0.4 A with 180° conduction angle. Using the equation of step 2 above:

$$\theta_{C-A} = \frac{125^\circ\text{C} - 35^\circ\text{C}}{0.84 \text{ W}} - 75 \text{ deg/W} = 32 \text{ deg/W}$$

Figure 4 shows that for θ_{C-A} of 32 deg/W, the area is 18 sq. in. The minimum dimensions of the sides should be:

$$\sqrt{\frac{\text{area}}{2}} \times \sqrt{\frac{\text{area}}{2}} = \sqrt{\frac{18}{2}} \times \sqrt{\frac{18}{2}} = 3'' \times 3''$$

NOTES: 8. The thyristor is mounted in the center of a square heat sink vertically positioned in still free air with both sides exposed. The heat-sink area is twice the area of one side.

9. θ_{C-A} includes the case-to-heat sink thermal resistance, θ_{C-HS} , in addition to the heat-sink-to-free-air thermal resistance, θ_{HS-A} , and is defined by the equation, $\theta_{C-A} = \theta_{C-HS} + \theta_{HS-A}$.

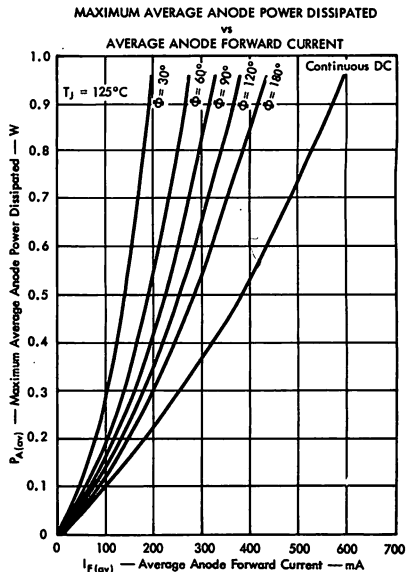

FIGURE 3

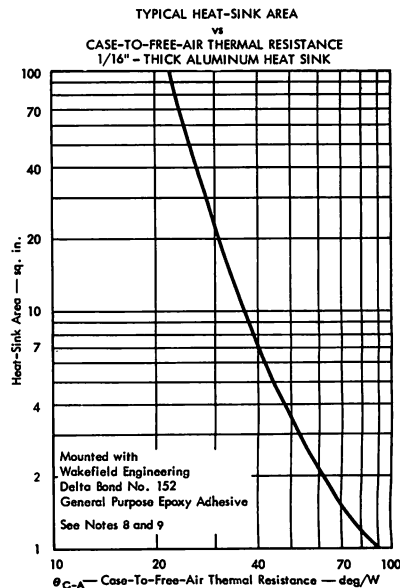

FIGURE 4

TYPES TIC44, TIC45, TIC46, TIC47 P-N-P-N PLANAR SILICON REVERSE-BLOCKING TRIODE THYRISTORS

THERMAL INFORMATION

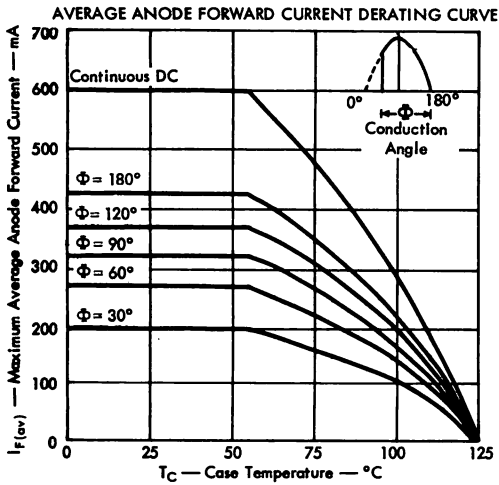

FIGURE 5

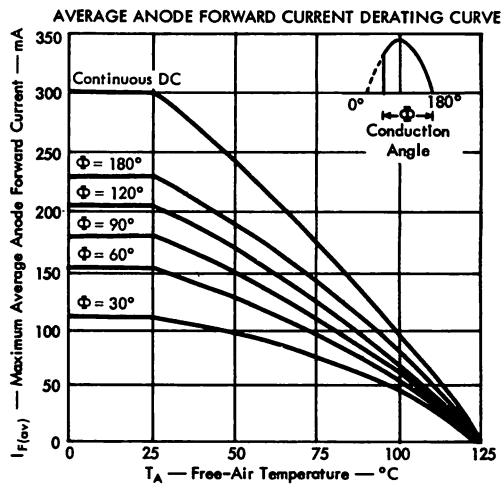

FIGURE 6

TYPICAL CHARACTERISTICS

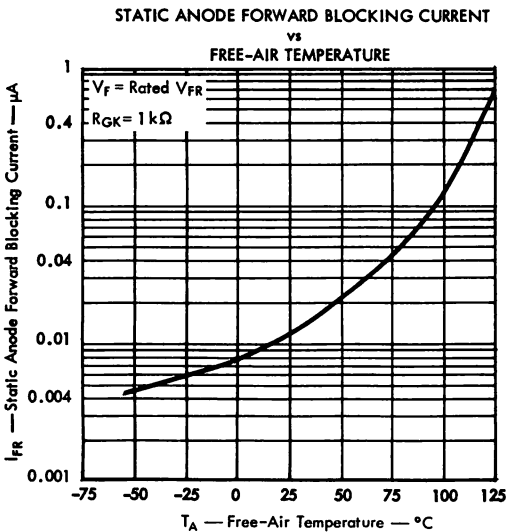

FIGURE 7

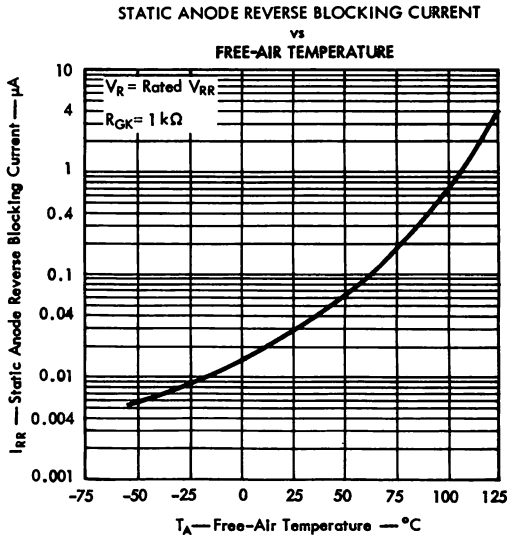

FIGURE 8

TYPES TIC44, TIC45, TIC46, TIC47

P-N-P-N PLANAR SILICON REVERSE-BLOCKING TRIODE THYRISTORS

TYPICAL CHARACTERISTICS

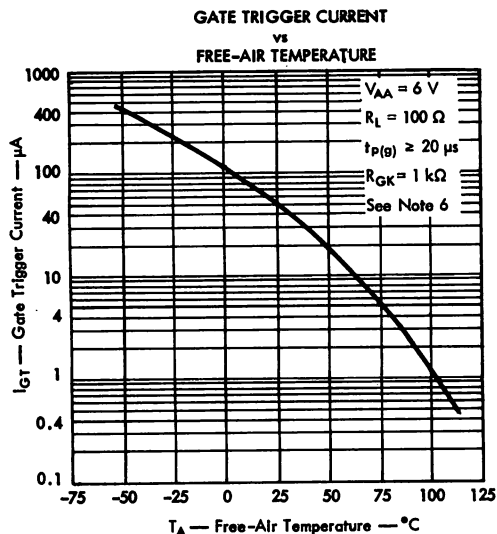

FIGURE 9

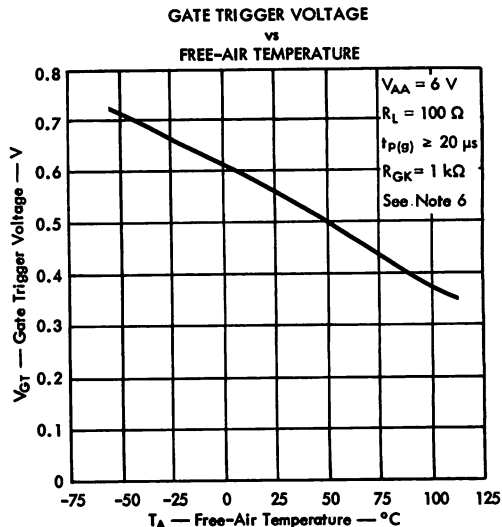

FIGURE 10

NOTE 6: When measuring these parameters, a 1 k Ω resistor should be used between gate and cathode to prevent triggering by random noise.

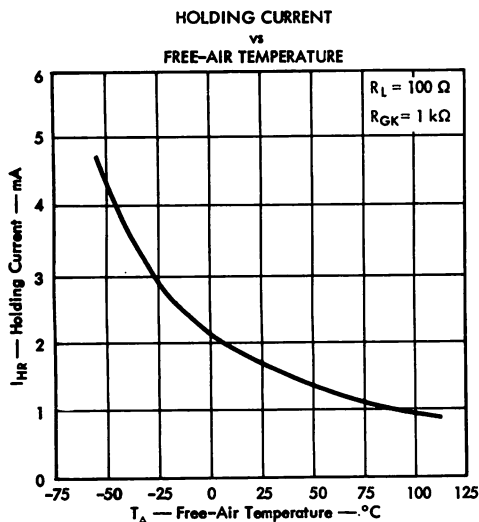

FIGURE 11

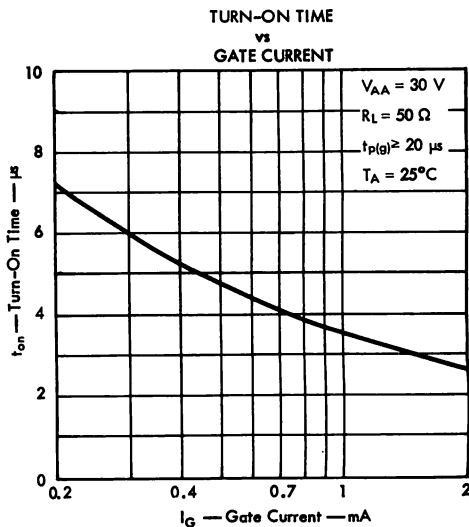
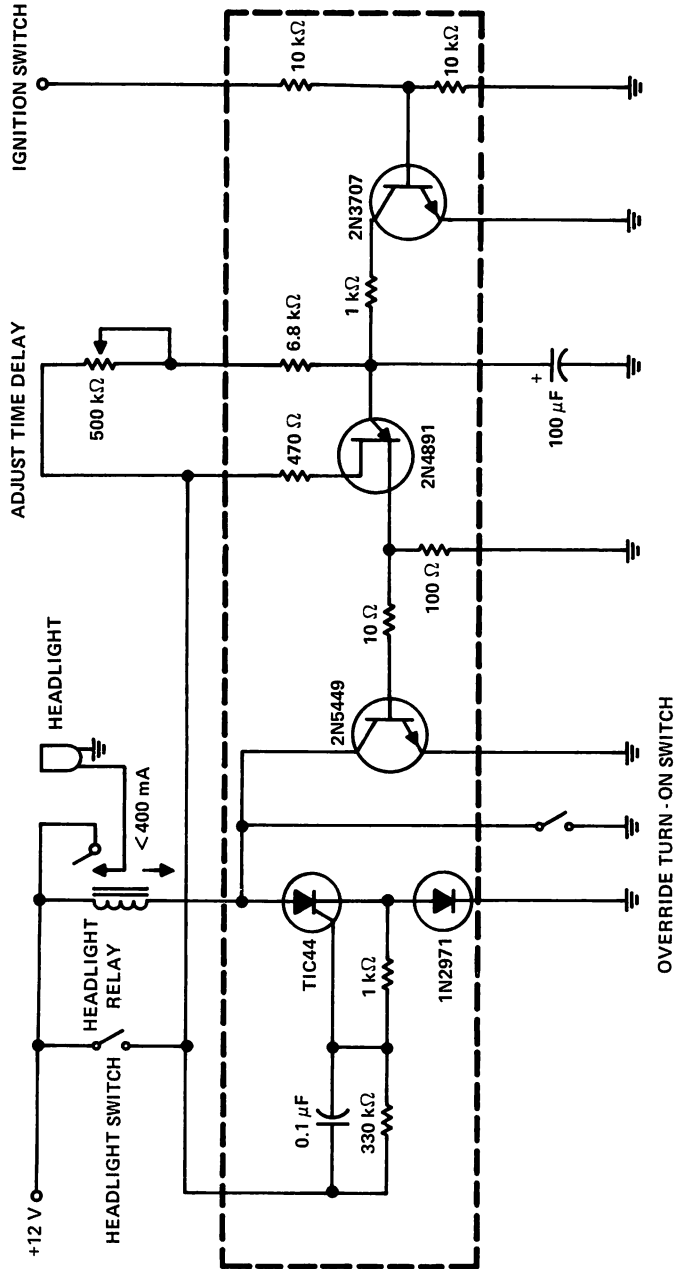

FIGURE 12

TYPES TIC44, TIC45, TIC46, TIC47 P-N-P-N PLANAR SILICON REVERSE-BLOCKING TRIODE THYRISTORS

TYPICAL APPLICATION DATA

AUTOMATIC TURN-OFF CONTROL FOR HEADLIGHTS



OVERRIDE TURN - ON SWITCH

CA17110

- Lights turn on with light switch.
- Lights turn off 1 second to 15 minutes (adjustable) after ignition is turned off.
- 2N4891 unijunction used as variable timer.

TI World-Wide Sales Offices

ALABAMA

Sahara Office Park Bldg., Suite 111
3313 Memorial Parkway, S.W.
Huntsville, Alabama 35801
205-881-4061

ARIZONA

2535 W. Camelback Rd., Suite 1D
Phoenix, Arizona 85017
602-279-5531

CALIFORNIA

1800 North Argyle Ave.
Hollywood, California 90028
213-466-7251

5005 West Century Blvd., Suite 208
Inglewood, California 90301
213-673-3943

230 California Ave., Suite 201
Palo Alto, California 94306
415-326-6770

1505 East 17th St., Suite 201
Santa Ana, California 92701
714-547-6506

4185 Adams Ave.
San Diego, California 92116
714-284-1181

COLORADO

2186 South Holly St., Suite 204
Denver, Colorado 80222
303-757-8548

CONNECTICUT

300 Amity Road
Woodbridge, Connecticut 06525
203-389-4521

FLORIDA

618 East South St., Suite 114
Orlando, Florida 32801
305-422-9894

ILLINOIS

Suite 205, Executive Towers
5901 N. Cicero Ave.
Chicago, Illinois 60646
312-286-1000

MASSACHUSETTS

60 Hickory Drive
Waltham, Mass. 02154
617-891-8450

MICHIGAN

Suite 706 West, Northland Towers Bldg.
15565 Northland Dr.
Southfield, Michigan 48075
313-357-1703

MINNESOTA

7615 Metro Blvd.
Suite 202, U.C.L.I. Bldg.
Edina, Minn. 55424
612-941-4384

NEW JERSEY

U.S. Highway #22
P.O. Box 366
Union, New Jersey 07083
201-687-7200

NEW YORK

P. O. Box 87, 2209 E. Mair.
Endicott, New York 13760
607-785-9987

4 Nevada Drive
New Hyde Park, N. Y. 11040
516-488-9894

131 Fulton Ave., Apt. J-2
Poughkeepsie, New York 12603
914-471-6095

6563 Ridings Rd.
Syracuse, New York 13206
315-463-9291

OHIO

22035 Chagrin Blvd.
Cleveland, Ohio 44122
216-751-2600

Suite 205, Paul Welch Bldg.
3300 South Dixie Dr.
Dayton, Ohio 45439
513-298-7513

PENNSYLVANIA

Benjamin Fox Pavilion
Suite 424, Foxcroft Square
Jenkintown, Pa. 19046
215-885-3454

TEXAS

MS80 — P.O. Box 5012
Dallas, Texas 75222
214-238-4861

3609 Buffalo Speedway
Houston, Texas 77006
713-526-3268

WASHINGTON

5801 Sixth Ave. S.
Seattle, Washington 98108
206-762-4240

WASHINGTON, D.C.

1875 Connecticut Ave., N.W., Suite 913
Washington, D.C. 20009
202-234-9320

CANADA

Geophysical Service Incorporated
280 Centre Str. East
Richmond Hills
Ontario, Canada
925-1035

663 Orly Avenue
Dorval
Quebec, Canada
631-6010

EUROPE

Texas Instruments Limited
Manton Lane
Bedford, England

Texas Instruments France S. A.
Boite Postale 5
Villeneuve-Loubet (A.M.), France

11 rue de Madrid
Paris 8°, France

Texas Instruments Holland N.V.
Semiconductor Division
Enschedeestraat 19
Hengelo (Ov), Holland

Texas Instruments Italia S.p.A.
Via Colautti 1
Milan, Italy

Texas Instruments Incorporated
118 Rue du Rhone
1204 Geneva, Switzerland

Texas Instruments Sweden A.B.
Timmermangatan 34, Box 17116
Stockholm 17, Sweden

Texas Instruments Deutschland GmbH
Hildesheimerstr. 19
3 Hannover, W. Germany

Texas Instruments Deutschland GmbH
Wolframstrasse 26
7 Stuttgart
West Germany

Texas Instruments Deutschland GmbH
Clemensstrasse 30
8 Munich 23
West Germany

Texas Instruments Deutschland GmbH
Kepserstrasse 33
805 Freising-Lerchenfeld
West Germany

Texas Instruments Deutschland GmbH
Koenigsbacherstrasse 22
6 Frankfurt, West Germany

MEXICO

Texas Instruments de Mexico S.A.
Poniente 116 #489
Col. Ind. Vallejo
Mexico 15, D.F.

ARGENTINA

Texas Instruments Argentina S.A.I.C.F.
(P. O. Box 2296 — Correo Central)
Ruta Panamericana Km. 13, 5
Don Torcuato
Buenos Aires, Argentina

BRAZIL

Texas Instrumentos Electronicos
do Brazil Ltda.
Rua Cesario Alvim 770
Caixa Postal 30.103
Sao Paulo 6, Brazil

AUSTRALIA

Texas Instruments Australia Ltd.
Box 63, Oldham Road
Elizabeth, South Australia

Texas Instruments Australia Ltd.
Room 5, Rural Bank Bldg.
Burwood, N.S.W., Australia

JAPAN

Texas Instruments Asia Limited
404 T.B.R. Building
No. 59, 2-chome, Nagata-cho
Chiyoda-du, Tokyo, Japan

TYPES 2N3001, 2N3002, 2N3003, 2N3004 P-N-P-N PLANAR SILICON REVERSE-BLOCKING TRIODE THYRISTORS



TYPES 2N3001, 2N3002, 2N3003, 2N3004
 BULLETIN NO. DL-5 634260, AUGUST 1963

350 ma — 30 to 200 VOLTS — 20 μ a GATE SENSITIVITY

**ALL PLANAR, OXIDE-PASSIVATED JUNCTIONS
NO SOLDER OR FLUXES**

- High Operating Temperatures
- High Surge Current Capability
- Fast Switching Speeds
- Low Forward Voltage Drop

mechanical data

The devices are in a hermetically sealed welded case with a glass-to-metal seal between case and leads. Approximate weight is 0.35 gram.

	<p>* THE ANODE IS IN ELECTRICAL CONTACT WITH THE CASE</p> <p>* ALL JEDEC TO-18 DIMENSIONS AND NOTES ARE APPLICABLE.</p>	
--	---	--

absolute maximum ratings over operating free-air temperature range (unless otherwise noted)

	2N3001	2N3002	2N3003	2N3004	UNIT
*Continuous Forward Blocking Voltage, V_{FB} (See Note 1)	30	60	100	200	v
*Continuous Reverse Blocking Voltage, V_R	30	60	100	200	v
*Peak Forward Blocking Voltage (See Note 1)	30	60	100	200	v
*Peak Reverse Blocking Voltage	30	60	100	200	v
Peak Gate Reverse Voltage	8				v
*Continuous Anode Forward Current at (or below) 55°C Free-Air Temperature (See Note 2)	350				ma
*Continuous Anode Forward Current at 130°C Free-Air Temperature (See Note-2)	75				ma
*Average Anode Forward Current (180° Conduction Angle) at (or below) 55°C Free-Air Temperature (See Note 2)	250				ma
*Anode Surge Current (See Note 3)	6				a
*Peak Gate Forward Current (Pulse width \leq 8 msec)	250				ma
*Average Gate Power Dissipation	100				mw
*Operating Free-Air Temperature Range	- 65 to + 150				°C
*Storage Temperature Range	- 65 to + 200				°C

NOTES: 1. This value applies when the Gate-Cathode Resistance, $R_{GK} \leq 1 \text{ k}\Omega$.

2. For operation above 55°C free-air temperature, refer to Anode Forward Current Derating Curve, Figure 1.

3. This rating applies for one half-cycle sine wave, 60 cps, when the device is conducting maximum rated current immediately before and after the surge. Surge may be repeated after the device has returned to original thermal equilibrium conditions.

*Indicates JEDEC registered data.



TEXAS INSTRUMENTS
 INCORPORATED
 POST OFFICE BOX 5012 • DALLAS, TEXAS 75222

TYPES 2N3001, 2N3002, 2N3003, 2N3004

P-N-P-N PLANAR SILICON REVERSE-BLOCKING TRIODE THYRISTORS

*electrical characteristics at 25°C free-air temperature (unless otherwise noted)

PARAMETER	TEST CONDITIONS	MIN	TYP	MAX	UNIT
I_F Anode Forward Blocking Current†	$V_{AK} = \text{Rated } V_{FB}, R_{GK} = 1 \text{ k}\Omega$			20	ma
	$V_{AK} = \text{Rated } V_{FB}, R_{GK} = 1 \text{ k}\Omega, T_A = 150^\circ\text{C}$			20	μa
I_R Anode Reverse Blocking Current†	$V_{KA} = \text{Rated } V_R, R_{GK} = \infty$			0.1	μa
	$V_{KA} = \text{Rated } V_R, R_{GK} = \infty, T_A = 150^\circ\text{C}$			100	μa
I_{GR} Gate Reverse Current	$V_{KG} = 5 \text{ v}, R_L = \infty$			0.1	μa
$I_{GT(on)}$ Gate Trigger Current†	$V_{AA} = 5 \text{ v}, R_L = 12 \Omega$		5.0	20	μa
$V_{GT(on)}$ Gate Trigger Voltage†	$V_{AA} = 5 \text{ v}, R_L = 12 \Omega, T_A = -65^\circ\text{C}$			0.9	v
	$V_{AA} = 5 \text{ v}, R_L = 12 \Omega$		0.55	0.7	v
	$V_{AA} = 5 \text{ v}, R_L = 12 \Omega, T_A = 150^\circ\text{C}$	0.2			v
			1.2	3.0	ma
I_H Holding Current	$R_{GK} = 1 \text{ k}\Omega$			4.0	ma
v_F Peak Instantaneous Fwd. Voltage	$I_F = 350 \text{ ma}$, (See Note 4)			1.1	v
dV/dt Critical Rate of Anode Voltage Rise	$V_{KG} = 1.0 \text{ v}$		400		$\text{v}/\mu\text{sec}$

†For additional TI guaranteed characteristics, see Figures 2, 3, 6, and 7.

switching characteristics at 25°C free-air temperature

PARAMETER	TEST CONDITIONS	2N3004	UNIT
		TYP	
t_{on} Turn-On Time	$V_{AA} = 200 \text{ v}, R_L = 2.2 \text{ k}\Omega, R_G = 100 \Omega,$ $V_{in} = 3.0 \text{ v}$, (See Fig. 14)	0.3	μsec
t_{off} Commutating Turn-Off Time	$V_{AA} = 50 \text{ v}, R_L = 140 \Omega$, 1N645 between gate and cathode, (See Fig. 15)	3.5	μsec

thermal characteristics

PARAMETER	TYP	UNIT
θ_{J-C} Junction-to-Case Thermal Resistance	75	$^\circ\text{C}/\text{watt}$
θ_{J-A} Junction-to-Free-Air Thermal Resistance	275	$^\circ\text{C}/\text{watt}$

NOTE 4: These parameters must be measured using pulse techniques. Anode pulse width = 300 μsec , PRR = 10 pps.

* Indicates JEDEC registered data (typical data excluded).

ANODE FORWARD CURRENT DERATING CURVES

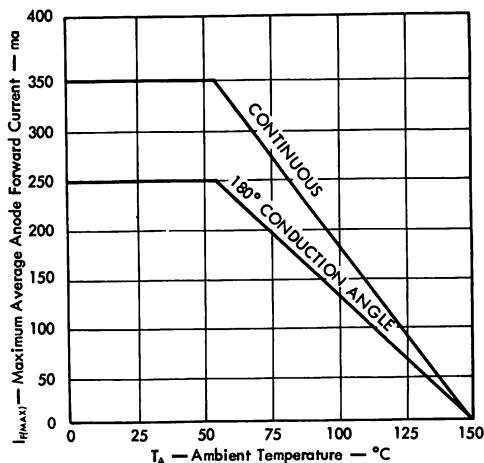
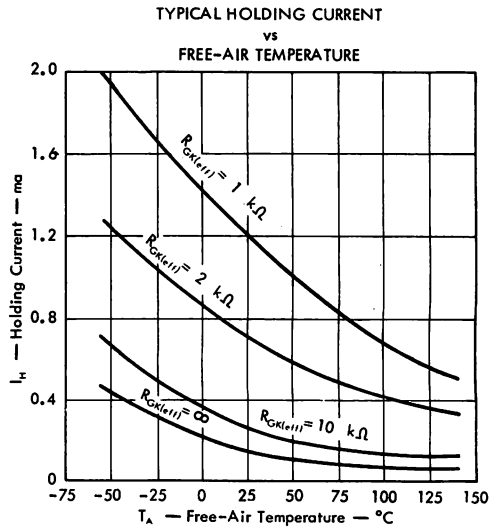
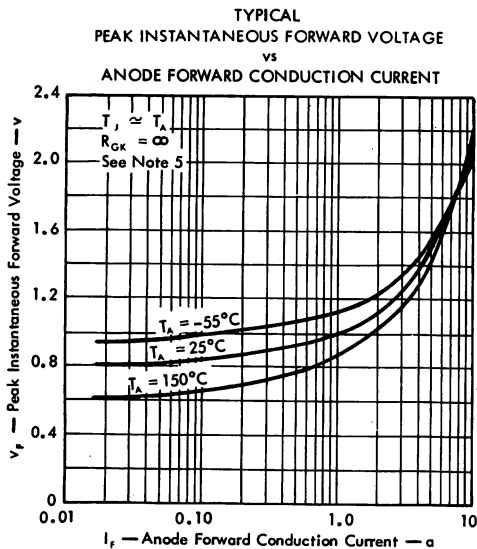
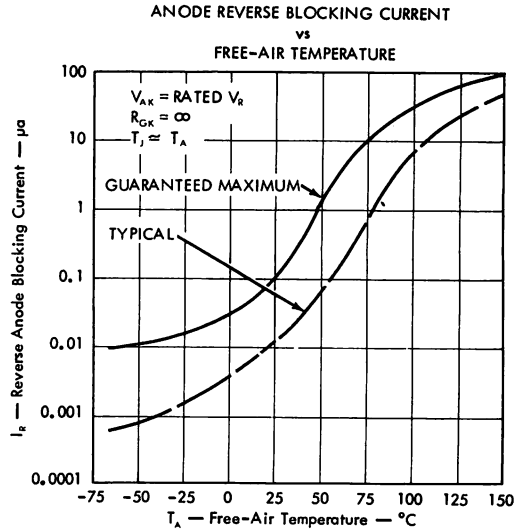
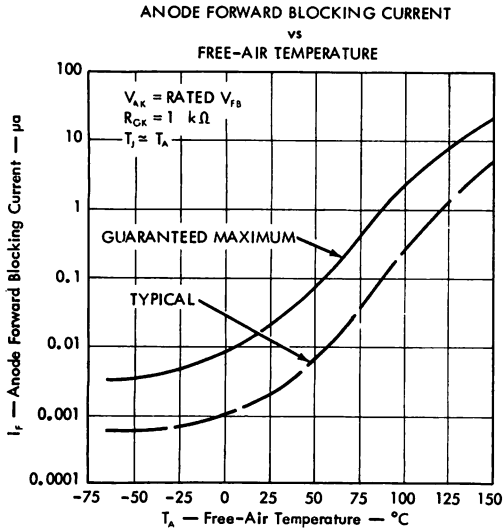

FIGURE 1

TYPES 2N3001, 2N3002, 2N3003, 2N3004 P-N-P-N PLANAR SILICON REVERSE-BLOCKING TRIODE THYRISTORS

ANODE CHARACTERISTICS



NOTE: 5. These parameters were measured using pulse techniques. Anode pulse width = 300 μ sec, PRR = 10 pps.

TYPES 2N3001, 2N3002, 2N3003, 2N3004 P-N-P-N PLANAR SILICON REVERSE-BLOCKING TRIODE THYRISTORS

GATE CHARACTERISTICS

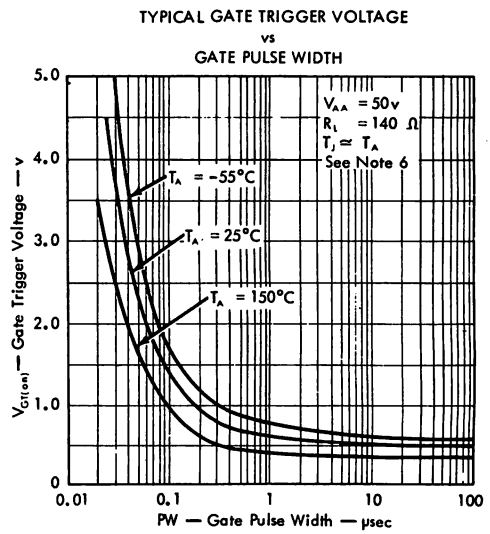
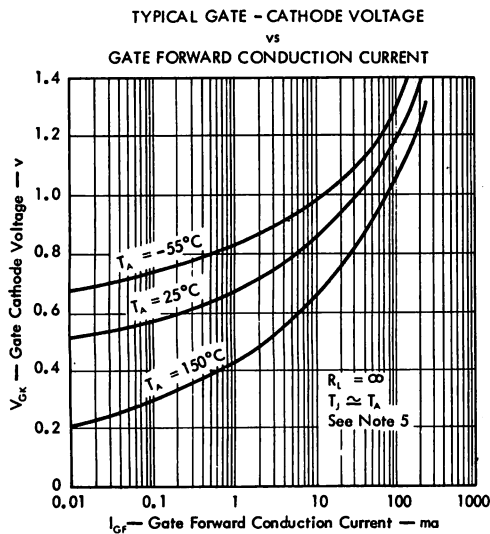
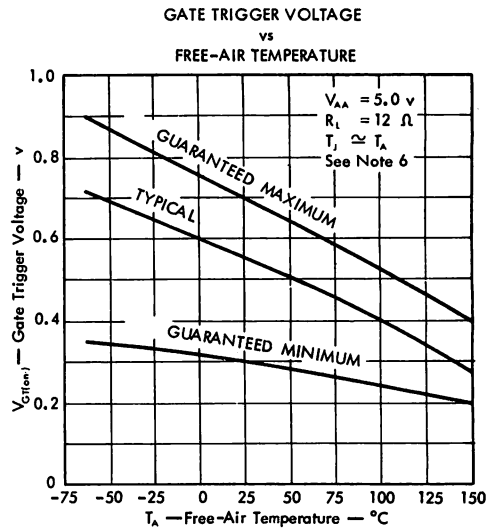
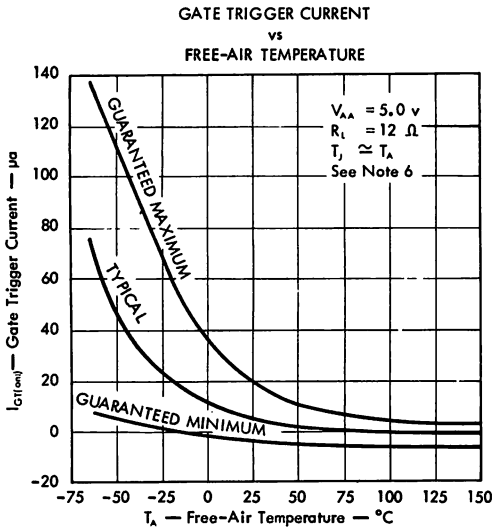

NOTE: 6. These parameters were measured using single pulse techniques. Anode pulse width = 300 μsec, Duty Cycle = 0.

TYPES 2N3001, 2N3002, 2N3003, 2N3004 P-N-P-N PLANAR SILICON REVERSE-BLOCKING TRIODE THYRISTORS

TYPICAL SWITCHING CHARACTERISTICS, $T_A = 25^\circ\text{C}$

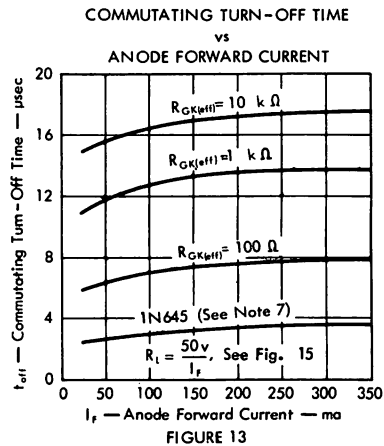
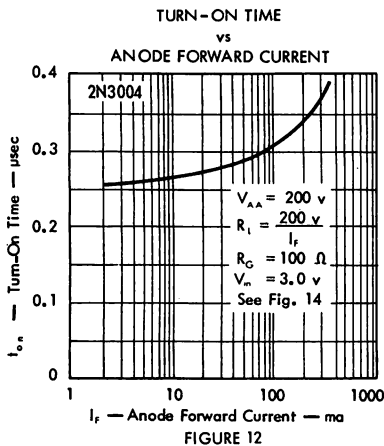
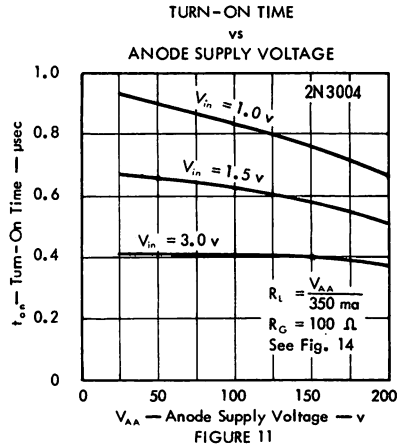
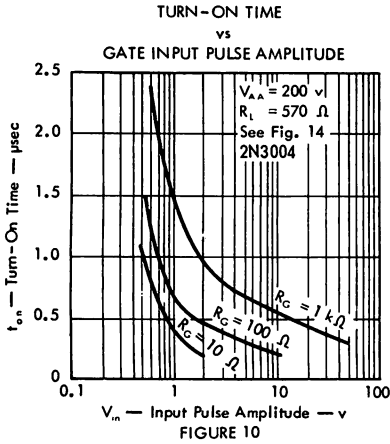

PARAMETER MEASUREMENT INFORMATION

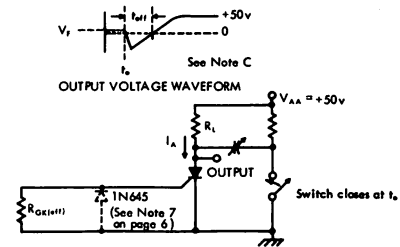
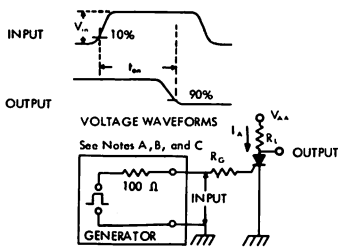

- NOTES: A. V_{in} is measured with gate and cathode terminals connected as shown and anode terminal open.
B. The input waveform has the following characteristics: $t_r \leq 40$ nsec, $PW \geq$ device turn-on time at the operating point.
C. Waveforms are monitored on an oscilloscope with following characteristics: $t_r \leq 14$ nsec, $R_{in} \geq 10$ M Ω , $C_{in} \leq 12$ pf.

TYPES 2N3001, 2N3002, 2N3003, 2N3004

P-N-P-N PLANAR SILICON REVERSE-BLOCKING TRIODE THYRISTORS

TYPICAL APPLICATION DATA

20-kc RING COUNTER

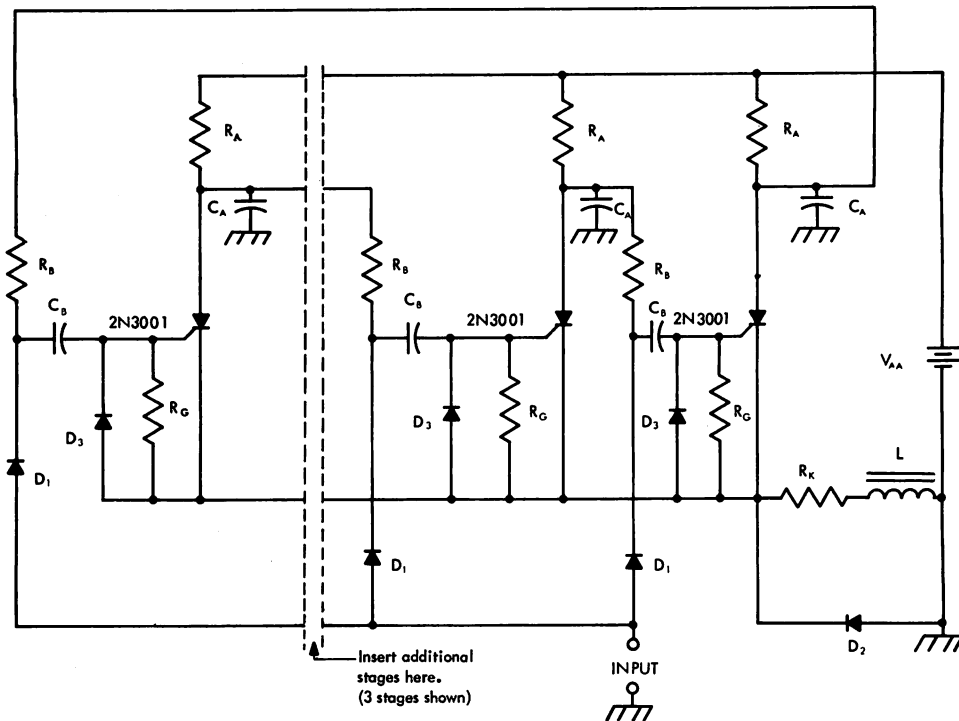

CIRCUIT PERFORMANCE CHARACTERISTICS FOR 10 STAGE OPERATION AT $T_A = 25^\circ\text{C}$

- V_{AA} Range for 20kc Operation: 6 v to 30 v (Rated V_{FB})
- V_{AA} Range for 10kc Operation: 2.75 v to 30 v (Rated V_{FB})
- Range of Input Amplitude for 10kc operation: 3v to 8 v

CIRCUIT COMPONENT INFORMATION

R_A : 330 Ω	C_A : 0.06 $\mu\text{f} \pm 20\%$
R_B : 33 k Ω	C_B : 0.001 $\mu\text{f} \pm 20\%$
R_G : 1 k Ω	L : 40 mh
R_K : 33 Ω	$D_1, D_2,$ and D_3 : 1N914

All Resistors, $\pm 5\%$ tolerance, $\frac{1}{2}$ w

NOTE: 7. The commutating turn-off time of the 2N3001 series thyristor is significantly affected by the source impedance of the gate firing circuit as shown in Fig. 13. Faster turn-off times are achieved when this impedance is low. However, some circuits require the use of a high source impedance, even though fast turn-off is desired. In these applications, a diode may be used to by-pass the gate-cathode junction, as shown in the circuit in Fig. 15. This diode improves commutating turn-off time by eliminating the effect of the gate-cathode recovery time.

TYPES 2N3005, 2N3006, 2N3007, 2N3008 P-N-P-N PLANAR SILICON REVERSE-BLOCKING TRIODE THYRISTORS



TYPES 2N3005, 2N3006, 2N3007, 2N3008
BULLETIN NO. D1-S 634267, SEPTEMBER 1963

350 ma — 30 to 200 VOLTS — 200 μ a GATE SENSITIVITY

**ALL PLANAR, OXIDE-PASSIVATED JUNCTIONS
NO SOLDER OR FLUXES**

- High Operating Temperatures
- Fast Switching Speeds
- High Surge Current Capability
- Low Forward Voltage Drop
- Gate Turn-Off Capability

mechanical data

The devices are in a hermetically sealed welded case with a glass-to-metal seal between case and leads. Approximate weight is 0.35 gram.

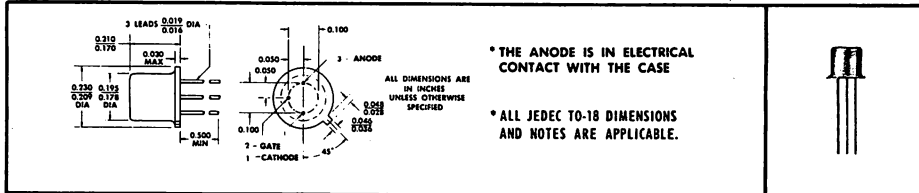

absolute maximum ratings over operating free-air temperature range (unless otherwise noted)

	2N3005	2N3006	2N3007	2N3008	UNIT
*Continuous Forward Blocking Voltage, V_{FB} (See Note 1)	30	60	100	200	v
*Continuous Reverse Blocking Voltage, V_R	30	60	100	200	v
*Peak Forward Blocking Voltage (See Note 1)	30	60	100	200	v
*Peak Reverse Blocking Voltage	30	60	100	200	v
Peak Gate Reverse Voltage	8				v
*Continuous Anode Forward Current at (or below) 55°C Free-Air Temperature (See Note 2)	350				ma
*Continuous Anode Forward Current at 130°C Free-Air Temperature (See Note 2)	75				ma
*Average Anode Forward Current (180° Conduction Angle) at (or below) 55°C Free-Air Temperature (See Note 2)	250				ma
*Anode Surge Current (See Note 3)	6				a
*Peak Gate Forward Current (Pulse width \leq 8 msec)	250				ma
*Average Gate Power Dissipation	100				mw
*Operating Free-Air Temperature Range	- 65 to + 150				°C
*Storage Temperature Range	- 65 to + 200				°C

NOTES: 1. This value applies when the Gate-Cathode Resistance, $R_{GK} \leq 1 \text{ k}\Omega$.

2. For operation above 55°C free-air temperature, refer to Anode Forward Current Derating Curve, Figure 1.

3. This rating applies for one half-cycle sine wave, 60 cps, when the device is conducting maximum rated current immediately before and after the surge. Surge may be repeated after the device has returned to original thermal equilibrium conditions.

*Indicates JEDEC registered data.



TEXAS INSTRUMENTS
INCORPORATED
POST OFFICE BOX 5012 • DALLAS, TEXAS 75222

TYPES 2N3005, 2N3006, 2N3007, 2N3008

P-N-P-N PLANAR SILICON REVERSE-BLOCKING TRIODE THYRISTORS

*electrical characteristics at 25°C free-air temperature (unless otherwise noted)

PARAMETER	TEST CONDITIONS	MIN	TYP	MAX	UNIT
I_F Anode Forward Blocking Current†	$V_{AK} = \text{Rated } V_{FB}, R_{GK} = 1 \text{ k}\Omega$			20	na
	$V_{AK} = \text{Rated } V_{FB}, R_{GK} = 1 \text{ k}\Omega, T_A = 150^\circ\text{C}$			20	μa
I_R Anode Reverse Blocking Current†	$V_{KA} = \text{Rated } V_{RB}, R_{GK} = \infty$			0.1	μa
	$V_{KA} = \text{Rated } V_{RB}, R_{GK} = \infty, T_A = 150^\circ\text{C}$			100	μa
I_{GR} Gate Reverse Current	$V_{KG} = 5 \text{ v}, R_L = \infty$			0.1	μa
$I_{GT(on)}$ Gate Trigger Current†	$V_{AA} = 5 \text{ v}, R_L = 12 \Omega$		90	200	μa
$V_{GT(on)}$ Gate Trigger Voltage†	$V_{AA} = 5 \text{ v}, R_L = 12 \Omega, T_A = -65^\circ\text{C}$			0.9	v
	$V_{AA} = 5 \text{ v}, R_L = 12 \Omega$		0.6	0.8	v
	$V_{AA} = 5 \text{ v}, R_L = 12 \Omega, T_A = 150^\circ\text{C}$	0.2			v
I_H Holding Current	$R_{GK} = 1 \text{ k}\Omega$		1.8	5.0	ma
	$R_{GK} = 1 \text{ k}\Omega, T_A = -65^\circ\text{C}$			8.0	ma
V_F Peak Instantaneous Fwd. Voltage	$I_F = 350 \text{ ma}$, (See Note 4)			1.1	v
dV/dt Critical Rate of Anode Voltage Rise	$V_{KG} = 1.0 \text{ v}$		400		$\text{v}/\mu\text{sec}$

†For additional TI guaranteed characteristics, see Figures 2, 3, 6, and 7.

switching characteristics at 25°C free-air temperature

PARAMETER	TEST CONDITIONS	2N3008	
		TYP	UNIT
t_{on} Turn-On Time	$V_{AA} = 200 \text{ v}, R_L = 2.2 \text{ k}\Omega, R_G = 100 \Omega,$ $V_{in} = 3.0 \text{ v}$, (See Fig. 14)	0.55	μsec
t_{off} Commutating Turn-Off Time	$V_{AA} = 50 \text{ v}, R_L = 140 \Omega,$ 1N645 between gate and cathode, (See Fig. 15)	2.2	μsec
$I_{GT(off)}$ Gate Turn-Off Current	$I_F = 200 \text{ ma}$ (See Note 5)	40	ma
$V_{GT(off)}$ Gate Turn-Off Voltage	$V_{AA} \leq 100 \text{ v}$ (Not to exceed Rated V_{FB})	4.0	v

thermal characteristics

PARAMETER	TYP	UNIT
θ_{J-C} Junction-to-Case Thermal Resistance	75	$^\circ\text{C}/\text{watt}$
θ_{J-A} Junction-to-Free-Air Thermal Resistance	275	$^\circ\text{C}/\text{watt}$

NOTE 4: These parameters must be measured using pulse techniques. Anode pulse width = 300 μsec , PRR = 10 pps.

NOTE 5: Anode current not to exceed 200 ma for gate turn-off applications.

* Indicates JEDEC registered data (typical data excluded).

ANODE FORWARD CURRENT DERATING CURVES

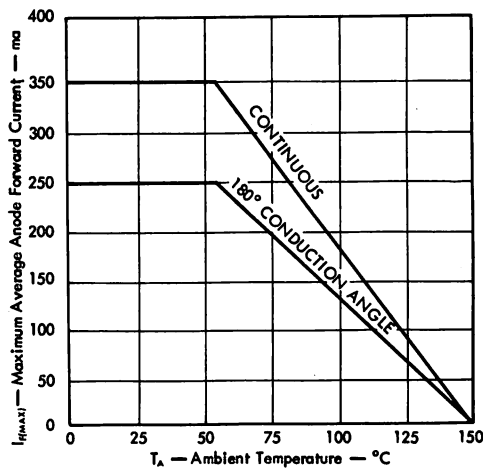
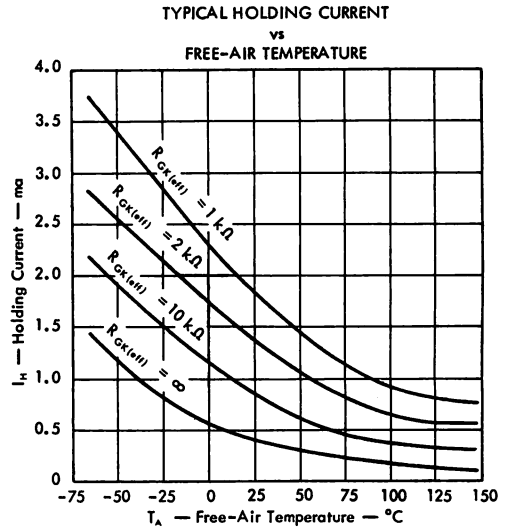
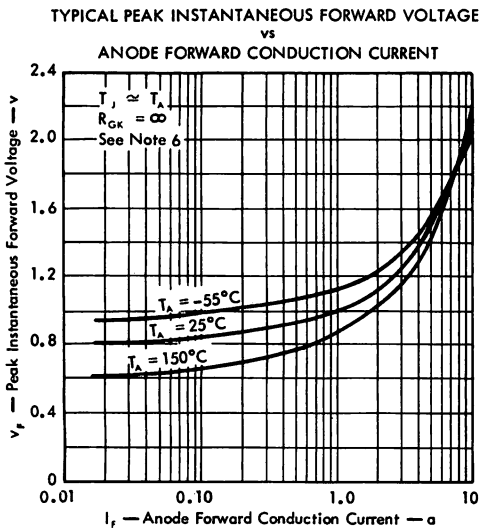
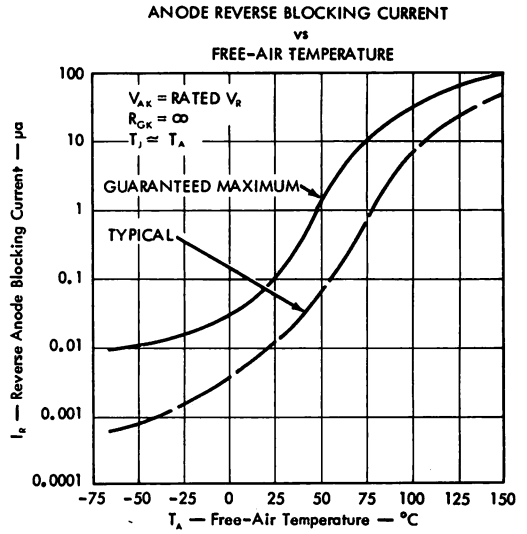
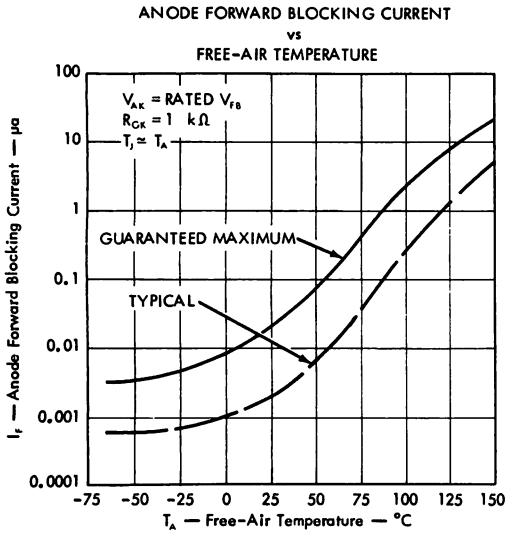

FIGURE 1

TYPES 2N3005, 2N3006, 2N3007, 2N3008 P-N-P-N PLANAR SILICON REVERSE-BLOCKING TRIODE THYRISTORS

ANODE CHARACTERISTICS



NOTE 6: These parameters were measured using pulse techniques. Anode pulse width = 300 μ sec, PRR = 10 pps.

TYPES 2N3005, 2N3006, 2N3007, 2N3008 P-N-P-N PLANAR SILICON REVERSE-BLOCKING TRIODE THYRISTORS

GATE CHARACTERISTICS

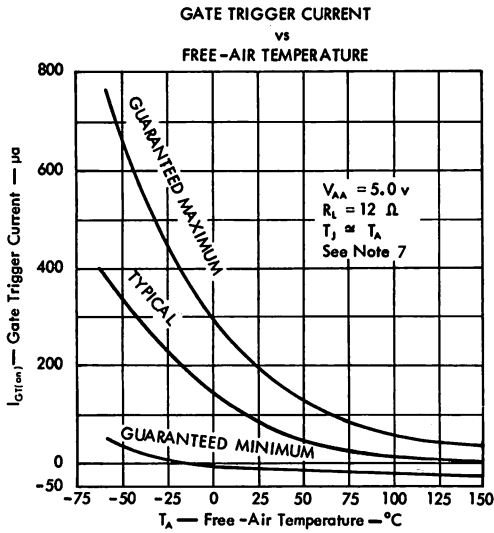

FIGURE 6

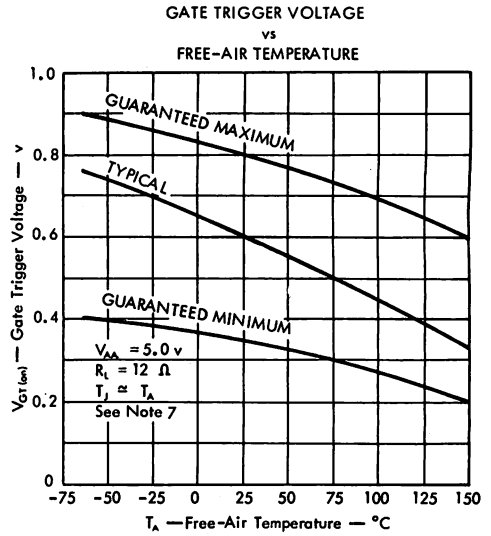

FIGURE 7

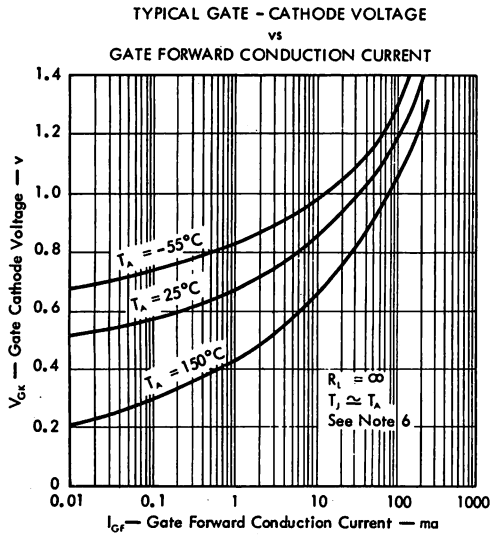

FIGURE 8

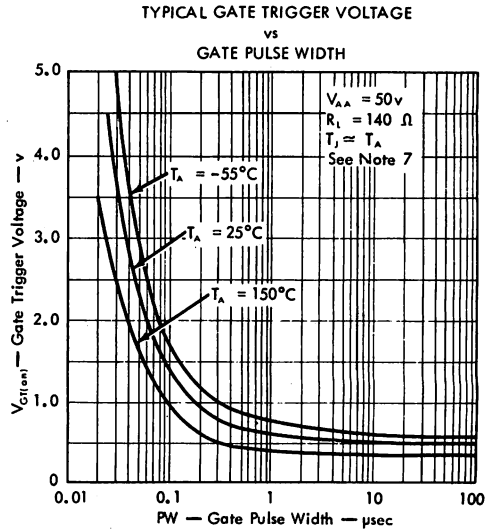
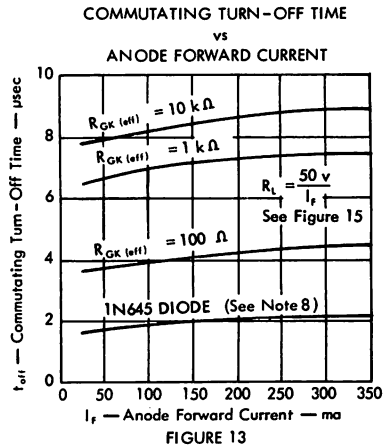
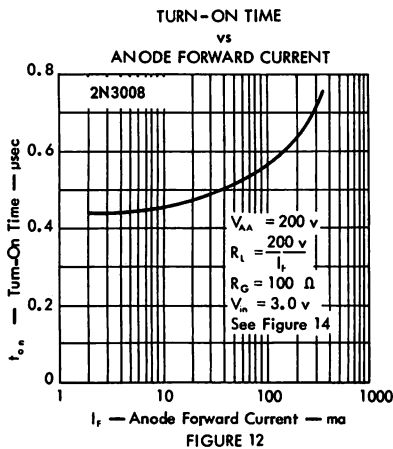
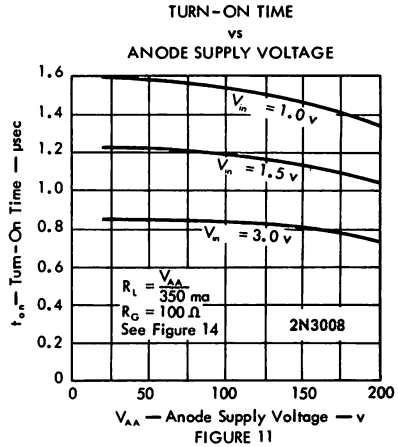
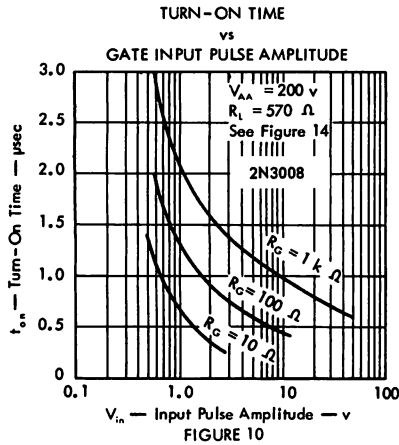

FIGURE 9

NOTE 7: These parameters were measured using single pulse techniques. Anode pulse width = 300 μ sec, Duty Cycle = 0.

TYPES 2N3005, 2N3006, 2N3007, 2N3008 P-N-P-N PLANAR SILICON REVERSE-BLOCKING TRIODE THYRISTORS

TYPICAL SWITCHING CHARACTERISTICS, $T_A = 25^\circ\text{C}$



PARAMETER MEASUREMENT INFORMATION

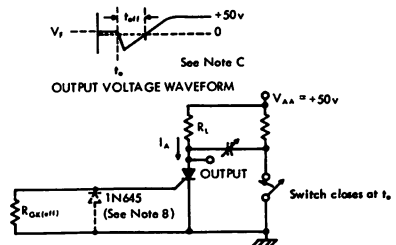
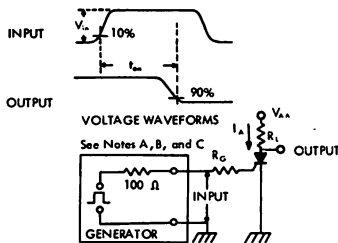

- NOTES: A. V_{in} is measured with gate and cathode terminals connected as shown and anode terminal open.
B. The input waveform has the following characteristics: $t_r \leq 40 \text{ nsec}$, $PW \geq$ device turn-on time at the operating point.
C. Wave forms are monitored on an oscilloscope with following characteristics $t_r \leq 14 \text{ nsec}$, $R_{in} \geq 10 \text{ M}\Omega$, $C_{in} \leq 12 \text{ pf}$.

TYPES 2N3005, 2N3006, 2N3007, 2N3008 P-N-P-N PLANAR SILICON REVERSE-BLOCKING TRIODE THYRISTORS

TYPICAL GATE TURN-OFF CHARACTERISTICS

The 2N3005 series thyristors exhibit gate turn-off gain, in addition to the standard controlled switch characteristics. Figure 16 shows the typical gate turn-off gain as a function of anode current. This characteristic offers increased flexibility in the design of pulse-width modulators, pulse-forming networks, static switches, choppers, bistable-circuits and inverters.

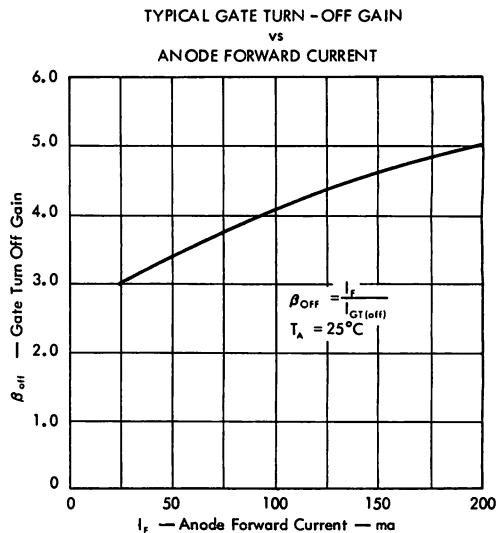
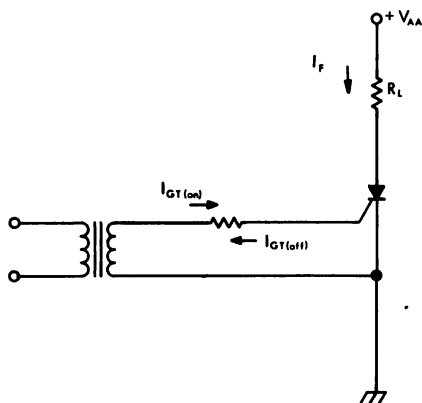
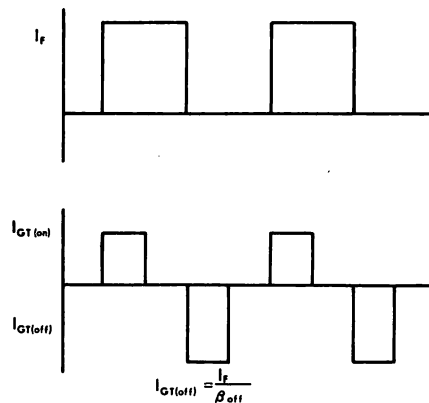

FIGURE 16



TYPICAL GATE TURN - OFF CIRCUIT



TYPICAL WAVEFORMS

Improved turn-off time may be realized using the gate turn-off method. A combination of gate turn-off and standard commutating turn-off will further improve the turn-off time. For applications requiring a guaranteed β_{off} , contact your nearest TI Sales Office for information on special types.

NOTE 8: The commutating turn-off time of the 2N3005 series thyristor is significantly affected by the source impedance of the gate firing circuit as shown in Fig. 13. Faster turn-off times are achieved when this impedance is low. However, some circuits require the use of a high source impedance, even though fast turn-off is desired. In these applications, a diode may be used to by-pass the gate-cathode junction, as shown in the circuit in Fig. 15. This diode improves commutating turn-off time by eliminating the effect of the gate-cathode recovery time.

TYPES 2N3555, 2N3556, 2N3557, 2N3558 P-N-P-N PLANAR SILICON REVERSE-BLOCKING TRIODE THYRISTORS



TYPES 2N3555, 2N3556, 2N3557, 2N3558
BULLETIN NO. DL-5 645905, AUGUST 1964

1 AMP AVG — 30 to 200 VOLTS — 20 μ a GATE SENSITIVITY
ALL PLANAR, OXIDE-PASSIVATED JUNCTIONS
NO SOLDER OR FLUXES

- High Operating Temperatures
- High Surge Current Capability
- Fast Switching Speeds
- Low Forward Voltage Drop

mechanical data

These devices are in precision welded, hermetically sealed enclosures. Extreme cleanliness during the assembly process prevents sealed-in contamination. The approximate unit weight is 1.8 grams.

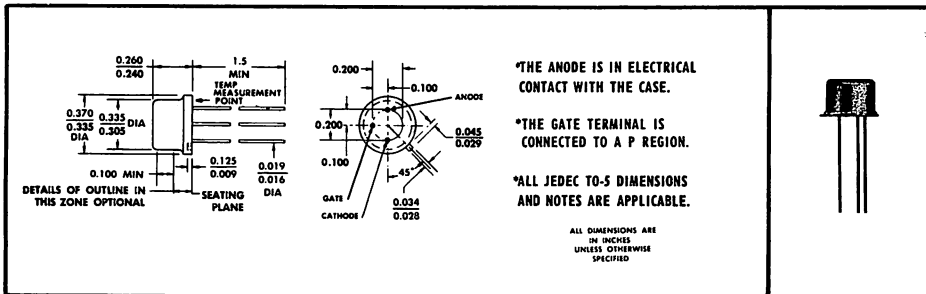

*absolute maximum ratings over operating case temperature range (unless otherwise noted)

	2N3555	2N3556	2N3557	2N3558	UNIT
Continuous Forward Blocking Voltage, V_{FR} (See Note 1)	30	60	100	200	v
Peak Forward Blocking Voltage (See Note 1)	30	60	100	200	v
Continuous Reverse Blocking Voltage, V_{RC} (See Note 2)	30	60	100	200	v
Peak Reverse Blocking Voltage (See Note 2)	30	60	100	200	v
Continuous or RMS Anode Forward Current at (or below) 100°C Case Temperature (See Note 3)	1.6				a
Average Anode Forward Current (180° Conduction Angle) at (or below) 100°C Case Temperature (See Note 4)	1				a
Peak Anode Surge Current (See Note 5)	18				a
Peak Gate Reverse Voltage	8				v
Peak Gate Forward Current (Pulse width \leq 8 msec)	250				ma
Average Gate Power Dissipation	100				mw
Operating Case Temperature Range	-65 to +150				°C
Storage Temperature Range	-65 to +200				°C

- NOTES: 1. These values apply when the gate-cathode resistance $R_{GK} \leq 1 \text{ k}\Omega$.
 2. These values apply when the gate-cathode resistance $R_{GK} = \infty$.
 3. This value applies for continuous d-c or single-phase, 60-cps, half-sine-wave operation with resistive load. Above 100°C, derate according to Figure 13.
 4. This value may be applied continuously under single-phase, 60-cps, half-sine-wave operation with resistive load. Above 100°C, derate according to Figure 13.
 5. This value applies for one 60-cps half sine wave when the device is operating at (or below) rated values of peak reverse blocking voltage and anode forward current. Surge may be repeated after the device has returned to original thermal equilibrium.

*Indicates JEDEC registered data



TEXAS INSTRUMENTS
INCORPORATED
POST OFFICE BOX 5012 • DALLAS, TEXAS 75222

TYPES 2N3555, 2N3556, 2N3557, 2N3558

P-N-P-N PLANAR SILICON REVERSE-BLOCKING TRIODE THYRISTORS

*electrical characteristics at 25°C case temperature (unless otherwise noted)

PARAMETER	TEST CONDITIONS	MIN	TYP	MAX	UNIT
I_{FR} Static Anode Forward Blocking Current	$V_{AK} = \text{Rated } V_{FR}, R_{GK} = 1 \text{ k}\Omega$			20	na
	$V_{AK} = \text{Rated } V_{FR}, R_{GK} = 1 \text{ k}\Omega, T_C = 150^\circ\text{C}$			20	μa
I_{RO} Static Anode Reverse Blocking Current	$V_{KA} = \text{Rated } V_{RO}, I_G = 0$			0.1	μa
	$V_{KA} = \text{Rated } V_{RO}, I_G = 0, T_C = 150^\circ\text{C}$			100	μa
I_{GKO} Gate Reverse Current	$V_{KG} = 5 \text{ v}, I_A = 0$			-0.1	μa
I_{GT} Gate Trigger Current	$V_{AA} = 5 \text{ v}, R_L = 12 \Omega, PW_G \geq 10 \mu\text{sec}$		5	20	μa
V_{GT} Gate Trigger Voltage	$V_{AA} = 5 \text{ v}, R_L = 12 \Omega, PW_G \geq 10 \mu\text{sec}, T_C = -65^\circ\text{C}$			0.9	v
	$V_{AA} = 5 \text{ v}, R_L = 12 \Omega, PW_G \geq 10 \mu\text{sec}$		0.55	0.7	v
	$V_{AA} = 5 \text{ v}, R_L = 12 \Omega, PW_G \geq 10 \mu\text{sec}, T_C = 150^\circ\text{C}$	0.2			v
I_{HR} Holding Current	$R_{GK} = 1 \text{ k}\Omega, R_L = 2 \text{ k}\Omega$		1.2	3	ma
	$R_{GK} = 1 \text{ k}\Omega, R_L = 2 \text{ k}\Omega, T_C = -65^\circ\text{C}$			4	ma
V_F Forward Voltage	$I_F = 1.6 \text{ a}, R_{GK} \geq 1 \text{ k}\Omega, \text{ See Note 6}$			1.4	v
dv/dt Critical Rate of Anode Voltage Rise	$V_{KG} = 1 \text{ v}$		400		v/ μsec

switching characteristics at 25°C case temperature (unless otherwise noted)

PARAMETER	TEST CONDITIONS	2N3558	UNIT
		TYP	
t_{on} Turn-On Time	$V_{AA} = 200 \text{ v}, R_L = 2.2 \text{ k}\Omega, R_G = 100 \Omega, V_{in} = 3 \text{ v}, \text{ See Fig. 14}$	0.3	μsec
t_{off} Commutating Turn-Off Time	$V_{AA} = 50 \text{ v}, R_L = 140 \Omega, 1N645 \text{ between gate and cathode, See Fig. 15}$	3.5	μsec

thermal characteristics

PARAMETER	MAX	UNIT
θ_{J-C} Junction-to-Case Thermal Resistance	35	$^\circ\text{C}/\text{w}$

NOTE 6: The initial instantaneous value is measured using pulse techniques. Anode-pulse width = 300 μsec , PRR = 10 pps.

*Indicates JEDEC registered data (typical data excluded).

TYPES 2N3555, 2N3556, 2N3557, 2N3558 P-N-P-N PLANAR SILICON REVERSE-BLOCKING TRIODE THYRISTORS

ANODE CHARACTERISTICS

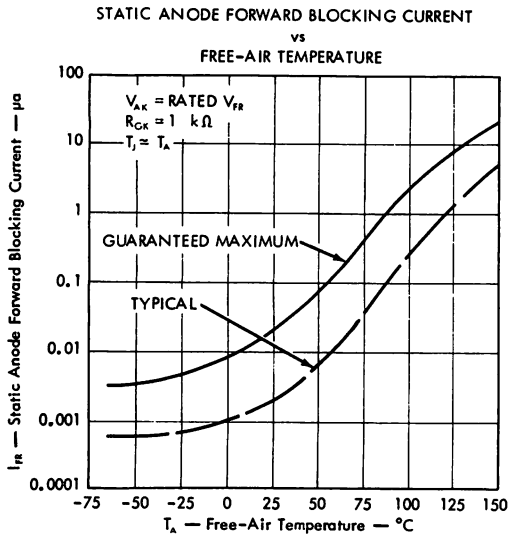

FIGURE 1

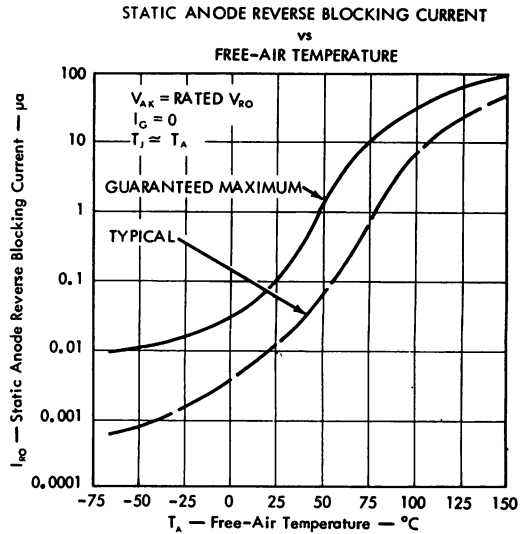

FIGURE 2

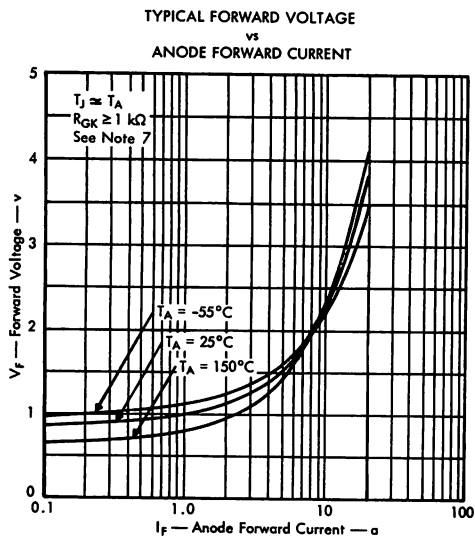

FIGURE 3

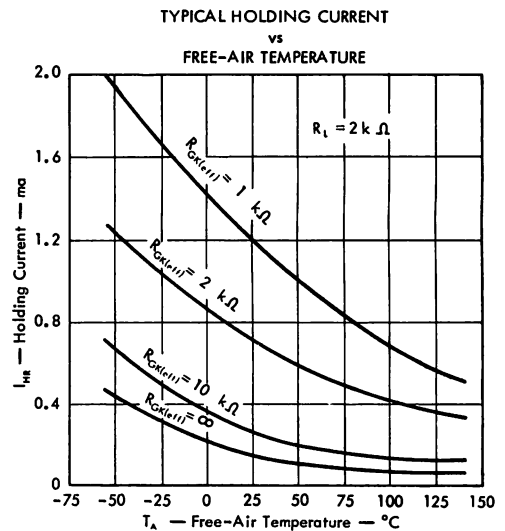

FIGURE 4

NOTE 7: These parameters were measured using pulse techniques. Anode-pulse width = 300 μsec , PRR = 10 pps.

TYPES 2N3555, 2N3556, 2N3557, 2N3558

P-N-P-N PLANAR SILICON REVERSE-BLOCKING TRIODE THYRISTORS

GATE CHARACTERISTICS

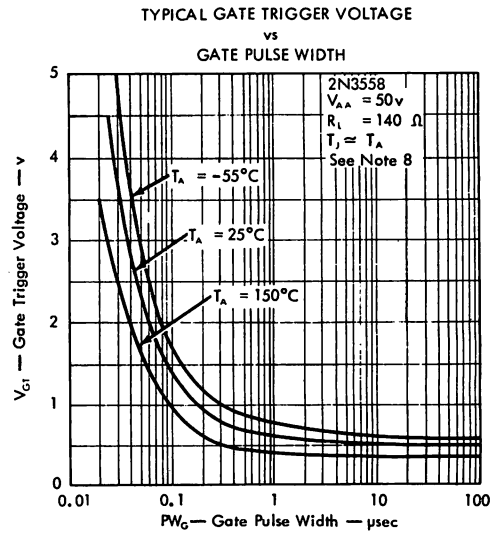
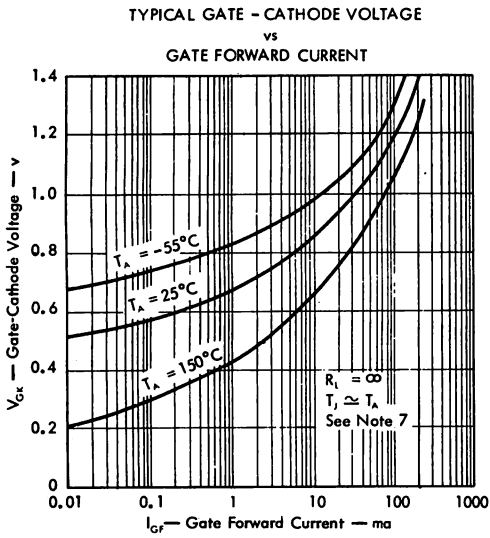
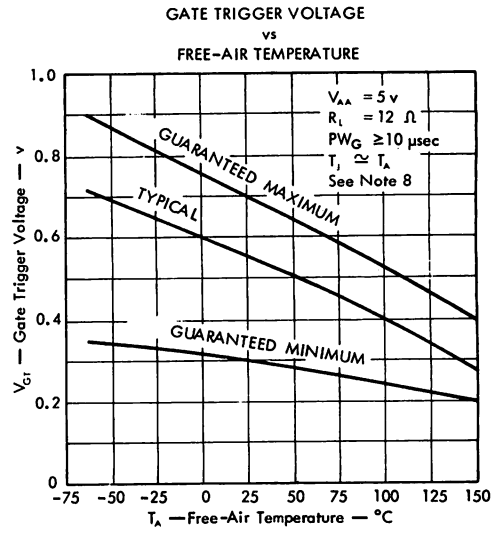
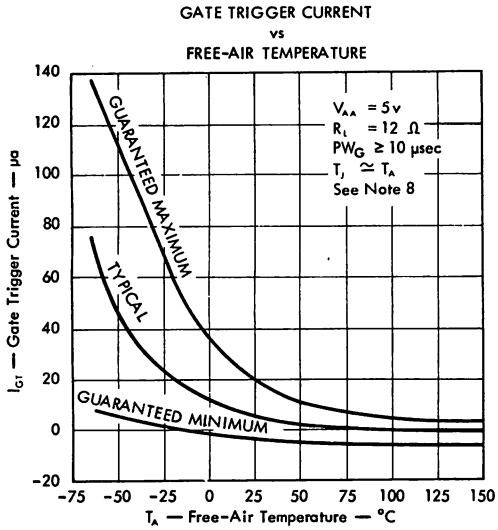

NOTES: 7. These parameters were measured using pulse techniques. Anode-pulse width = 300 μ sec, PRR = 10 pps.

8. These parameters were measured using single pulse techniques. Anode-pulse width = 300 μ sec, Duty Cycle = 0.

TYPES 2N3555, 2N3556, 2N3557, 2N3558 P-N-P-N PLANAR SILICON REVERSE-BLOCKING TRIODE THYRISTORS

TYPICAL SWITCHING CHARACTERISTICS, $T_A = 25^\circ\text{C}$

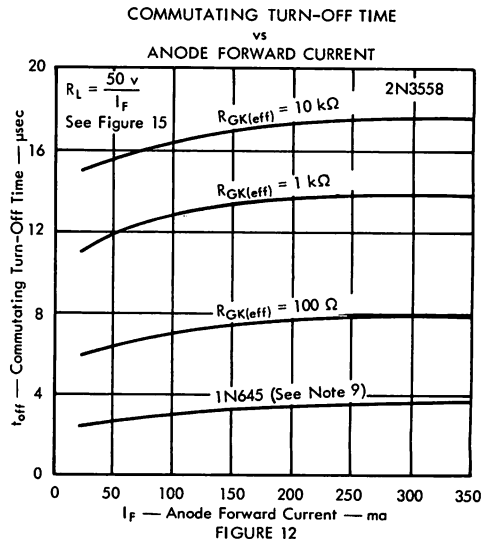
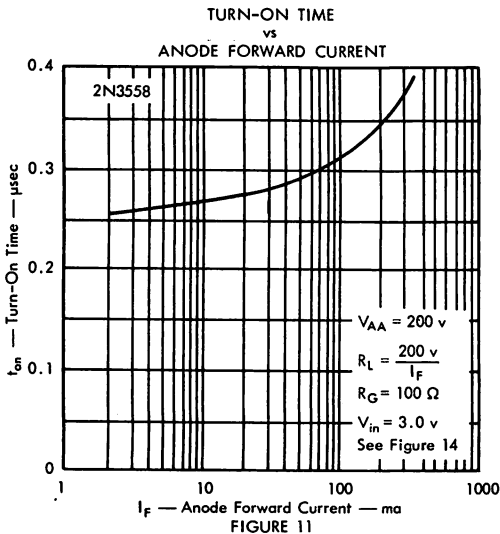
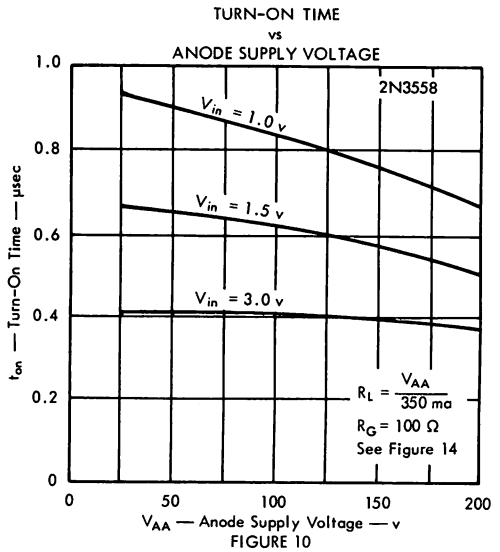
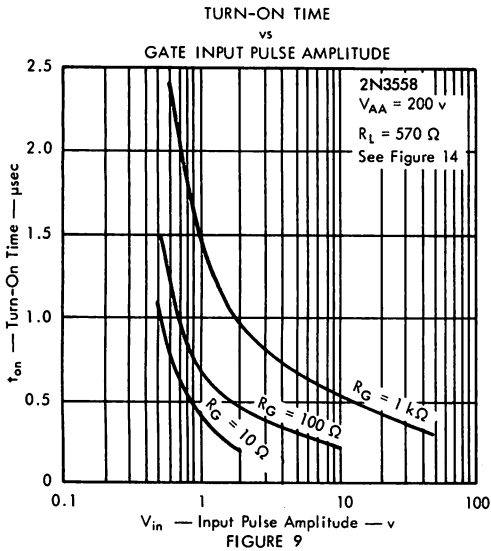

NOTE 9: The commutating turn-off time of the 2N3555 series thyristor is significantly affected by the source impedance of the gate firing circuit as shown in Figure 12. Faster turn-off times are achieved when this impedance is low. However, some circuits require the use of a high source impedance, even though fast turn-off is desired. In these applications, a diode may be used to by-pass the gate-cathode junction, as shown in the circuit in Figure 15. This diode improves commutating turn-off time by eliminating the effect of the gate-cathode recovery time.

TYPES 2N3555, 2N3556, 2N3557, 2N3558

P-N-P-N PLANAR SILICON REVERSE-BLOCKING TRIODE THYRISTORS

ANODE FORWARD CURRENT DERATING CURVE

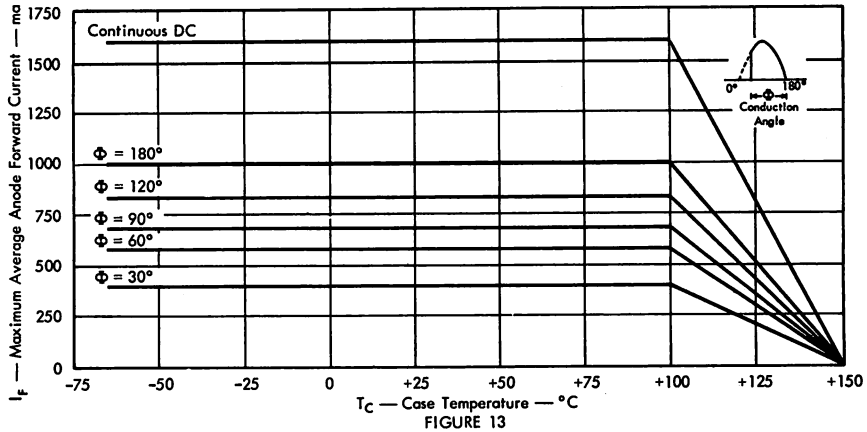

PARAMETER MEASUREMENT INFORMATION

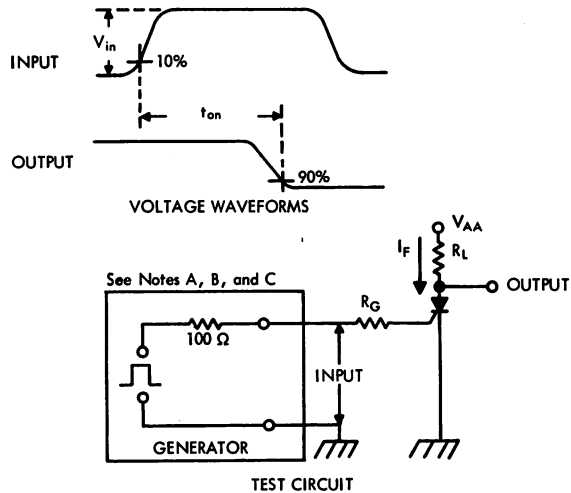
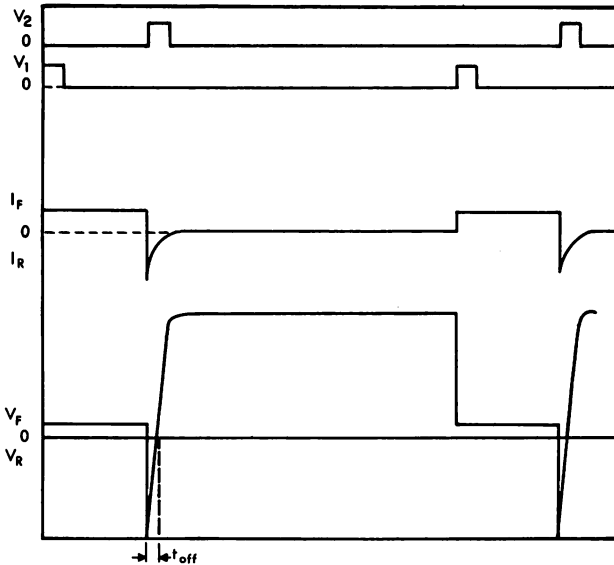

FIGURE 14 — TURN-ON TIME

- NOTES:
- V_{in} is measured with gate and cathode terminals connected as shown and anode terminal open.
 - The input waveform of Figure 14 has the following characteristics: $t_r \leq 40$ nsec, $PW \geq$ device turn-on time at the operating point.
 - Waveforms are maintained on an oscilloscope with following characteristics: $t_r \leq 14$ nsec, $R_{in} \geq 10$ k Ω , $C_{in} \leq 12$ pf.

TYPES 2N3555, 2N3556, 2N3557, 2N3558 P-N-P-N PLANAR SILICON REVERSE-BLOCKING TRIODE THYRISTORS

PARAMETER MEASUREMENT INFORMATION



WAVEFORMS

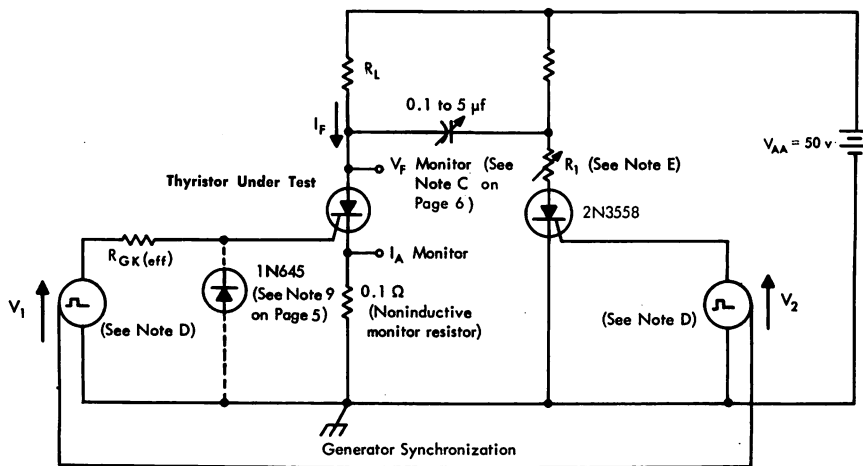

TEST CIRCUIT

FIGURE 15 — COMMUTATING TURN-OFF TIME

- D. Pulse generators for V_1 and V_2 are synchronized to provide an anode current waveform with the following characteristics: $PW=50$ to $300 \mu\text{sec}$, Duty Cycle = 1%. The pulse widths of V_1 and V_2 are $\geq 10 \mu\text{sec}$.
- E. Resistor R_1 is adjusted for $I_R=1 \text{ a}$.

TYPES 2N3555, 2N3556, 2N3557, 2N3558

P-N-P-N PLANAR SILICON REVERSE-BLOCKING TRIODE THYRISTORS

TYPICAL APPLICATION DATA

20-kc RING COUNTER

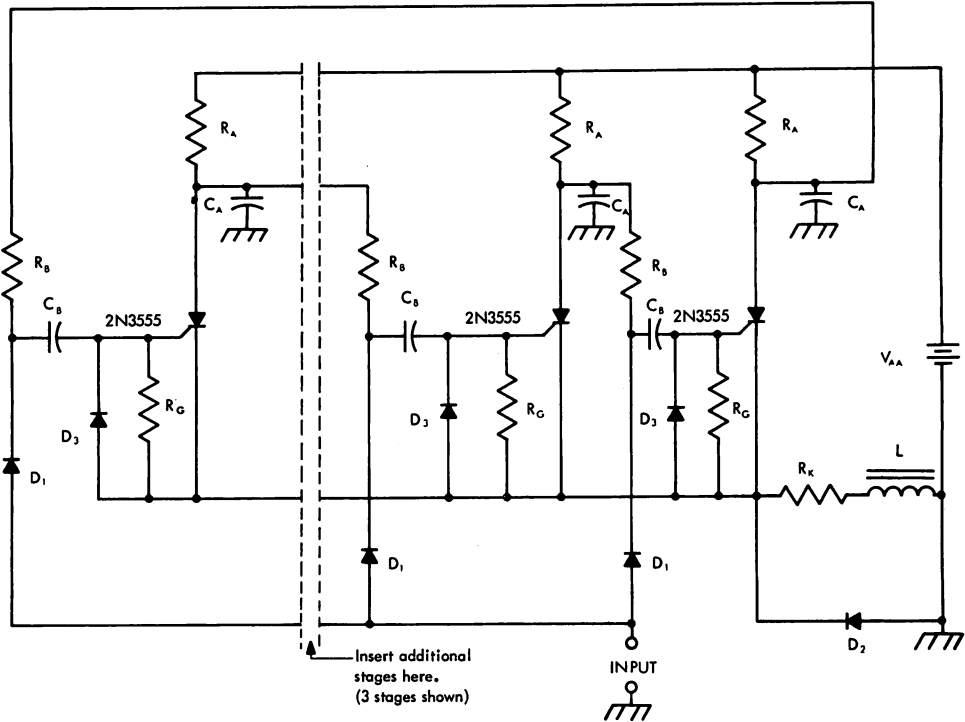

CIRCUIT PERFORMANCE CHARACTERISTICS FOR 10-STAGE OPERATION AT $T_A = 25^\circ\text{C}$

- V_{AA} Range for 20-kc Operation: 6 v to 30 v (Rated V_{FR})
- V_{AA} Range for 10-kc Operation: 2.75 v to 30 v (Rated V_{FR})
- Range of Input Amplitude for 10-kc operation: 3 v to 8 v

CIRCUIT COMPONENT INFORMATION

R_A : 330 Ω

C_A : 0.06 $\mu\text{f} \pm 20\%$

R_B : 33 k Ω

C_B : 0.001 $\mu\text{f} \pm 20\%$

R_C : 1 k Ω

L : 40 mh

R_K : 33 Ω

$D_1, D_2,$ and D_3 : 1N914

All Resistors, $\pm 5\%$ tolerance, $\frac{1}{2}$ w

TYPES 2N3559, 2N3560, 2N3561, 2N3562 P-N-P-N PLANAR SILICON REVERSE-BLOCKING TRIODE THYRISTORS



TYPES 2N3559, 2N3560, 2N3561, 2N3562
 BULLETIN NO. DL-5 645906, AUGUST 1964

1 AMP AVG — 30 to 200 VOLTS — 200 μ a GATE SENSITIVITY
ALL PLANAR, OXIDE-PASSIVATED JUNCTIONS
NO SOLDER OR FLUXES

- High Operating Temperatures
- High Surge Current Capability
- Fast Switching Speeds
- Low Forward Voltage Drop

mechanical data

These devices are in precision welded, hermetically sealed enclosures. Extreme cleanliness during the assembly process prevents sealed-in contamination. The approximate unit weight is 1.8 grams.

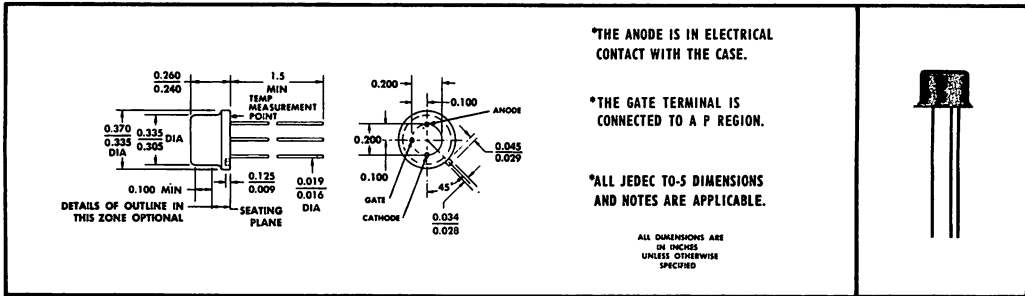

* absolute maximum ratings over operating case temperature range (unless otherwise noted)

	2N3559	2N3560	2N3561	2N3562	UNIT
Continuous Forward Blocking Voltage, V_{FR} (See Note 1)	30	60	100	200	v
Peak Forward Blocking Voltage (See Note 1)	30	60	100	200	v
Continuous Reverse Blocking Voltage, V_{RO} (See Note 2)	30	60	100	200	v
Peak Reverse Blocking Voltage (See Note 2)	30	60	100	200	v
Continuous or RMS Anode Forward Current at (or below) 100°C Case Temperature (See Note 3)	1.6				a
Average Anode Forward Current (180° Conduction Angle) at (or below) 100°C Case Temperature (See Note 4)	1				a
Peak Anode Surge Current (See Note 5)	18				a
Peak Gate Reverse Voltage	8				v
Peak Gate Forward Current (Pulse width \leq 8 msec)	250				ma
Average Gate Power Dissipation	100				mw
Operating Case Temperature Range	-65 to +150				°C
Storage Temperature Range	-65 to +200				°C

- NOTES: 1. These values apply when the gate-cathode resistance $R_{GK} \leq 1 \text{ k}\Omega$.
 2. These values apply when the gate-cathode resistance $R_{GK} = \infty$.
 3. This value applies for continuous d-c or single-phase, 60-cps, half-sine-wave operation with resistive load. Above 100°C, derate according to Figure 13.
 4. This value may be applied continuously under single-phase, 60-cps, half-sine-wave operation with resistive load. Above 100°C derate according to Figure 13.
 5. This value applies for one 60-cps half sine wave when the device is operating at (or below) rated values of peak reverse blocking voltage and anode forward current. Surge may be repeated after the device has returned to original thermal equilibrium.

*Indicates JEDEC registered data.



TEXAS INSTRUMENTS
 INCORPORATED
 POST OFFICE BOX 5012 • DALLAS, TEXAS 75222

TYPES 2N3559, 2N3560, 2N3561, 2N3562

P-N-P-N PLANAR SILICON REVERSE-BLOCKING TRIODE THYRISTORS

*electrical characteristics at 25°C case temperature (unless otherwise noted)

PARAMETER	TEST CONDITIONS	MIN	TYP	MAX	UNIT
I_{FR} Static Anode Forward Blocking Current	$V_{AK} = \text{Rated } V_{FR}, R_{GK} = 1 \text{ k}\Omega$			20	na
	$V_{AK} = \text{Rated } V_{FR}, R_{GK} = 1 \text{ k}\Omega, T_C = 150^\circ\text{C}$			20	μa
I_{RO} Static Anode Reverse Blocking Current	$V_{KA} = \text{Rated } V_{RO}, I_G = 0$			0.1	μa
	$V_{KA} = \text{Rated } V_{RO}, I_G = 0, T_C = 150^\circ\text{C}$			100	μa
I_{GKO} Gate Reverse Current	$V_{KG} = 5 \text{ v}, I_A = 0$			-0.1	μa
I_{GT} Gate Trigger Current	$V_{AA} = 5 \text{ v}, R_L = 12 \Omega, P_{WG} \geq 10 \mu\text{sec}$			90	μa
V_{GT} Gate Trigger Voltage	$V_{AA} = 5 \text{ v}, R_L = 12 \Omega, P_{WG} \geq 10 \mu\text{sec}, T_C = -65^\circ\text{C}$			0.9	v
	$V_{AA} = 5 \text{ v}, R_L = 12 \Omega, P_{WG} \geq 10 \mu\text{sec}$		0.6	0.8	v
	$V_{AA} = 5 \text{ v}, R_L = 12 \Omega, P_{WG} \geq 10 \mu\text{sec}, T_C = 150^\circ\text{C}$	0.2			v
I_{HR} Holding Current	$R_{GK} = 1 \text{ k}\Omega, R_L = 2 \text{ k}\Omega$		1.8	5	ma
	$R_{GK} = 1 \text{ k}\Omega, R_L = 2 \text{ k}\Omega, T_C = -65^\circ\text{C}$			8	ma
V_F Forward Voltage	$I_F = 1.6 \text{ a}, R_{GK} \geq 1 \text{ k}\Omega, \text{ See Note 6}$			1.4	v
I_{GO} Gate Turn-Off Current	$I_F = 200 \text{ ma}$ (See Note 7),		-40		ma
V_{GO} Gate Turn-Off Voltage	$V_{AA} \leq 100 \text{ v}$ (Not to exceed Rated V_{FR})		-4		v
dv/dt Critical Rate of Anode Voltage Rise	$V_{KG} = 1 \text{ v}$		400		v/ μsec

switching characteristics at 25°C case temperature (unless otherwise noted)

PARAMETER	TEST CONDITIONS	2N3562	UNIT
		TYP	
t_{on} Turn-On Time	$V_{AA} = 200 \text{ v}, R_L = 2.2 \text{ k}\Omega, R_G = 100 \Omega, V_{in} = 3 \text{ v}, \text{ See Fig. 14}$	0.55	μsec
t_{off} Commutating Turn-Off Time	$V_{AA} = 50 \text{ v}, R_L = 140 \Omega, 1N645 \text{ between gate and cathode}, \text{ See Fig. 15}$	2.2	μsec

thermal characteristics

PARAMETER	MAX	UNIT
θ_{JC} Junction-to-Case Thermal Resistance	35	$^\circ\text{C}/\text{w}$

NOTES: 6. The initial instantaneous value is measured using pulse techniques. Anode-pulse width = 300 μsec , PRR = 10 pps.
7. Anode current not to exceed 200 ma for gate turn-off applications.

*Indicates JEDEC registered data (typical data excluded).

TYPES 2N3559, 2N3560, 2N3561, 2N3562 P-N-P-N PLANAR SILICON REVERSE-BLOCKING TRIODE THYRISTORS

ANODE CHARACTERISTICS

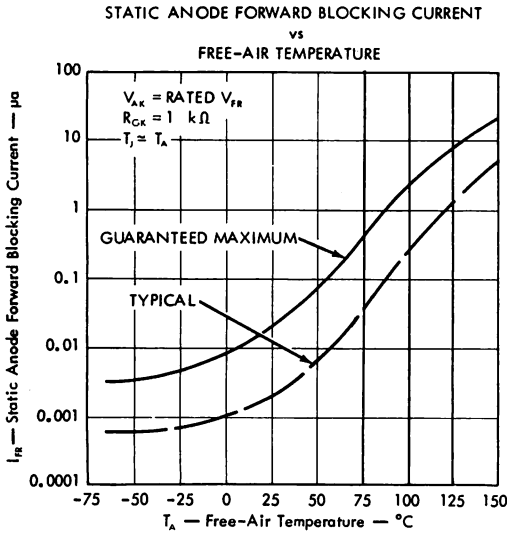

FIGURE 1

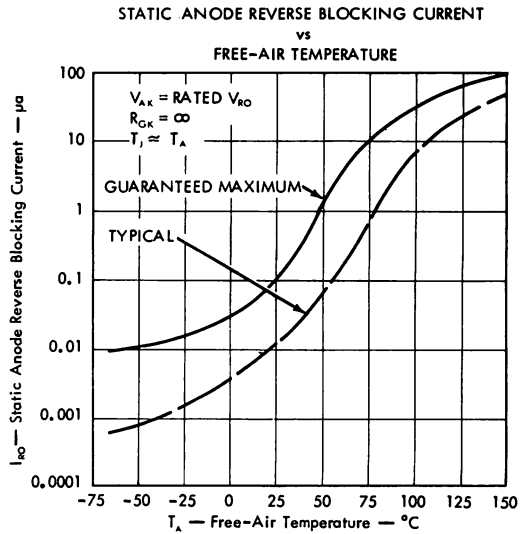

FIGURE 2

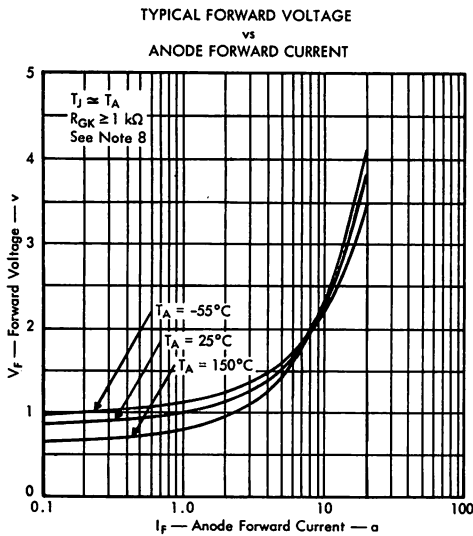

FIGURE 3

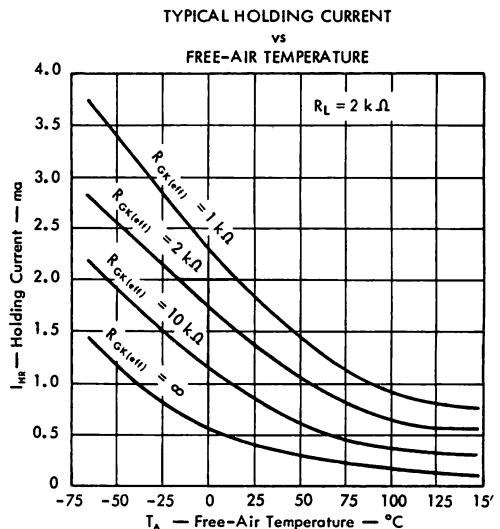

FIGURE 4

NOTE 8: These parameters were measured using pulse techniques. Anode-pulse width = 300 μ sec, PRR = 10 pps.

TYPES 2N3559, 2N3560, 2N3561, 2N3562

P-N-P-N PLANAR SILICON REVERSE-BLOCKING TRIODE THYRISTORS

GATE CHARACTERISTICS

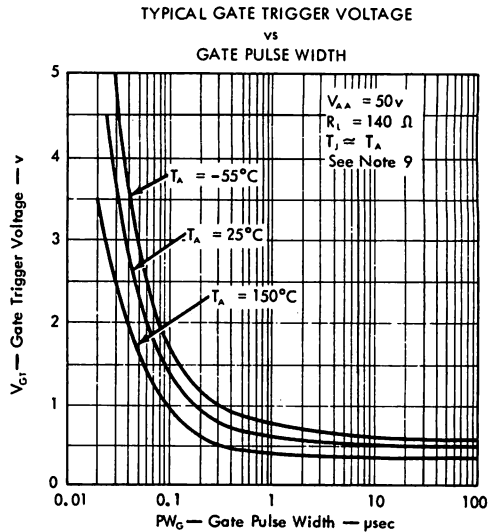
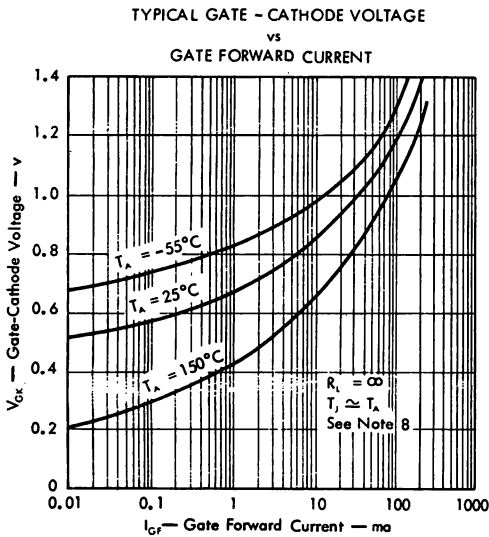
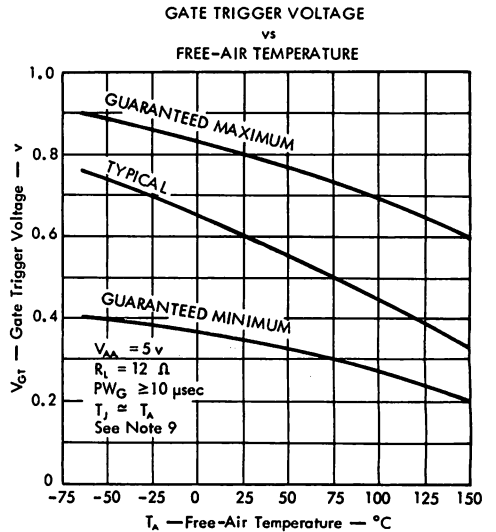
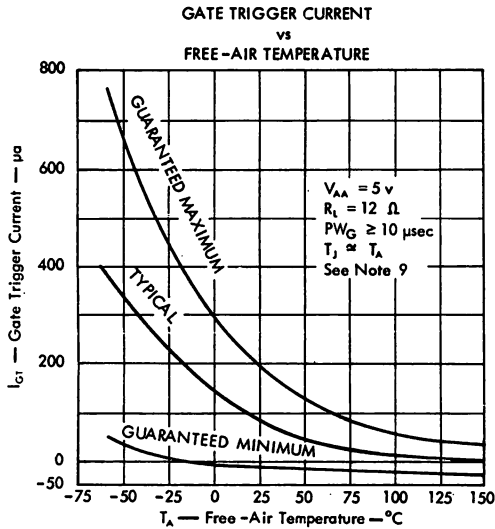

NOTES: 8. These parameters were measured using pulse techniques. Anode-pulse width = 300 μ sec, PRR = 10 pps.

9. These parameters were measured using single pulse techniques. Anode-pulse width = 300 μ sec, Duty Cycle = 0.

TYPES 2N3559, 2N3560, 2N3561, 2N3562 P-N-P-N PLANAR SILICON REVERSE-BLOCKING TRIODE THYRISTORS

TYPICAL SWITCHING CHARACTERISTICS, $T_A = 25^\circ\text{C}$

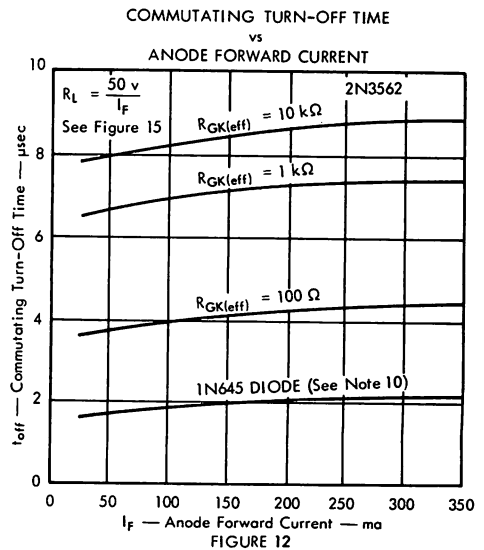
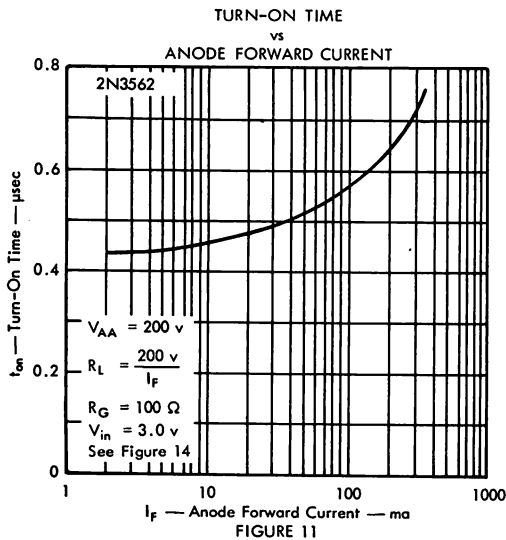
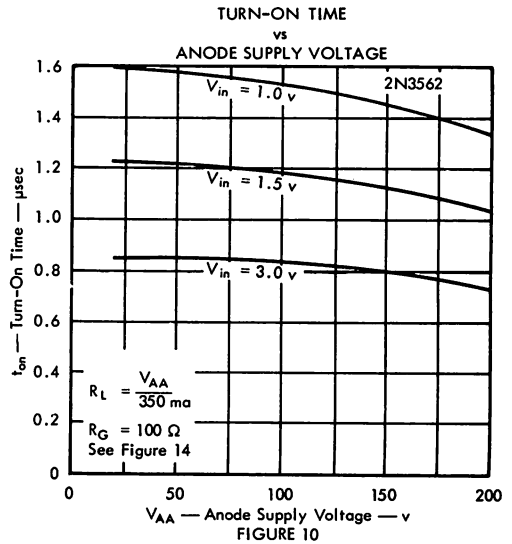
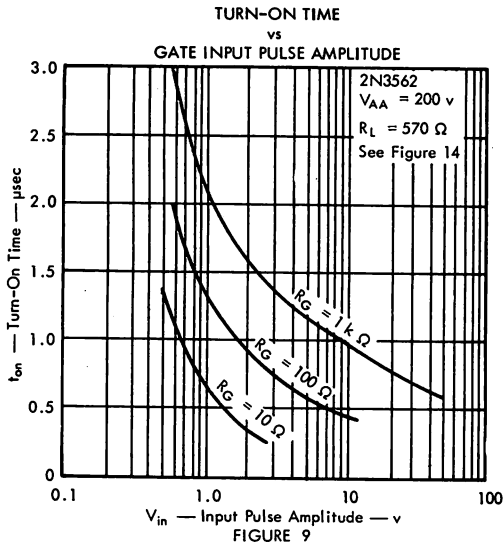

NOTE 10: The commutating turn-off time of the 2N3559 series thyristor is significantly affected by the source impedance of the gate firing circuit as shown in Fig. 12. Faster turn-off times are achieved when this impedance is low. However, some circuits require the use of a high source impedance, even though fast turn-off is desired. In these applications, a diode may be used to bypass the gate-cathode junction, as shown in the circuit in Fig. 15. This diode improves commutating turn-off time by eliminating the effect of the gate-cathode recovery time.

TYPES 2N3559, 2N3560, 2N3561, 2N3562

P-N-P-N PLANAR SILICON REVERSE-BLOCKING TRIODE THYRISTORS

ANODE FORWARD CURRENT DERATING CURVE

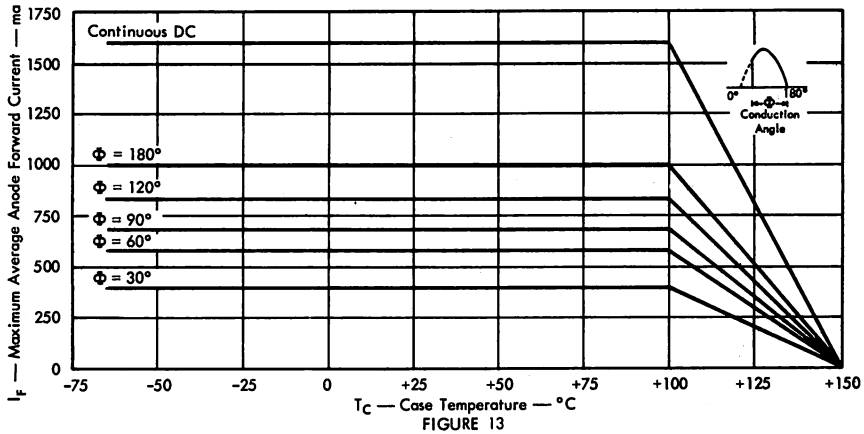

PARAMETER MEASUREMENT INFORMATION

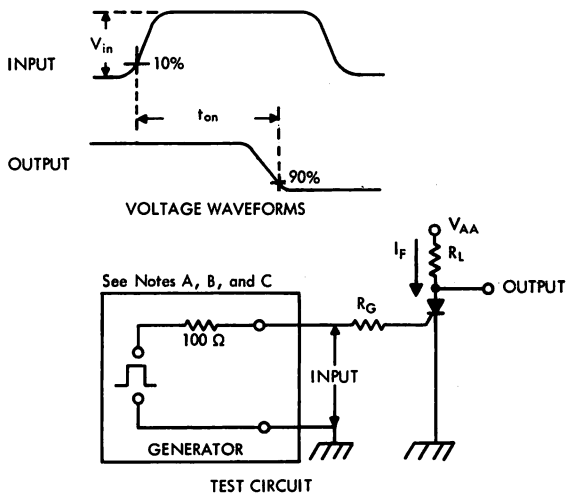
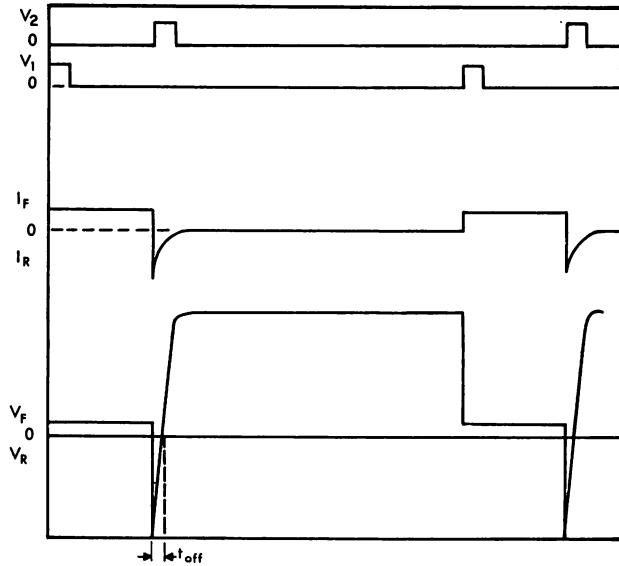

FIGURE 14 — TURN-ON TIME

- NOTES: A. V_{in} is measured with gate and cathode terminals connected as shown and anode terminal open.
 B. The input waveform of Figure 14 has the following characteristics: $t_r \leq 40$ nsec, $PW \geq$ device turn-on time at the operating point.
 C. Waveforms are monitored on an oscilloscope with following characteristics $t_r \leq 14$ nsec, $R_{in} \geq 10$ M Ω , $C_{in} \leq 12$ pf.

TYPES 2N3559, 2N3560, 2N3561, 2N3562 P-N-P-N PLANAR SILICON REVERSE-BLOCKING TRIODE THYRISTORS

PARAMETER MEASUREMENT INFORMATION



WAVEFORMS

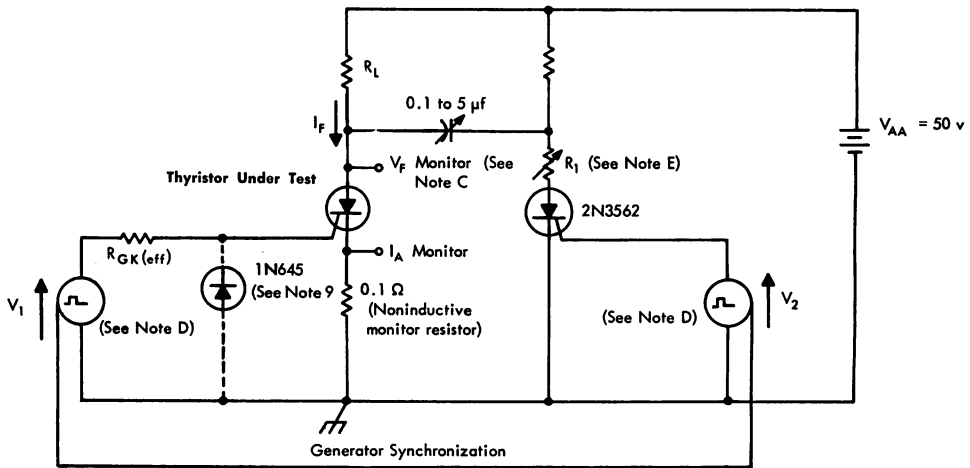

TEST CIRCUIT

FIGURE 15 — COMMUTATING TURN-OFF TIME

D. Pulse generators for V_1 and V_2 are synchronized to provide an anode current waveform with the following characteristics: PW=50 to 300 μsec , duty cycle=1%. The pulse widths of V_1 and V_2 are $\geq 10 \mu sec$.

E. Resistor R_1 is adjusted for $I_R=1 a$.

TYPES 2N3559, 2N3560, 2N3561, 2N3562

P-N-P-N PLANAR SILICON REVERSE-BLOCKING TRIODE THYRISTORS

TYPICAL GATE TURN-OFF CHARACTERISTICS

The 2N3559 series thyristors exhibit gate-turn-off gain, in addition to the standard controlled switch characteristics. Figure 16 shows the typical gate-turn-off gain as a function of anode current. This characteristic offers increased flexibility in the design of pulse-width modulators, pulse-forming networks, static switches, choppers, bistable circuits and inverters.

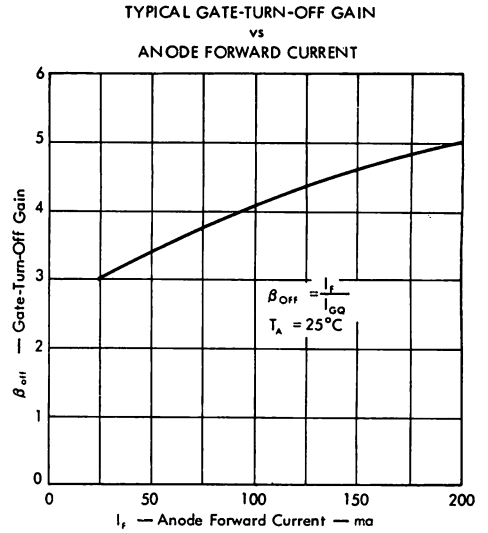
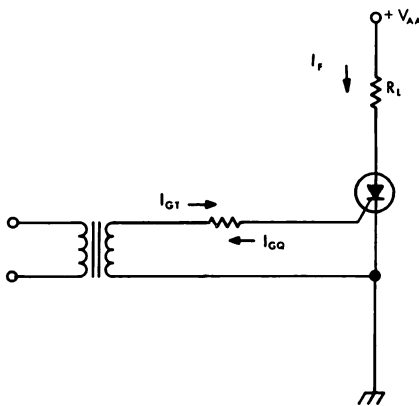
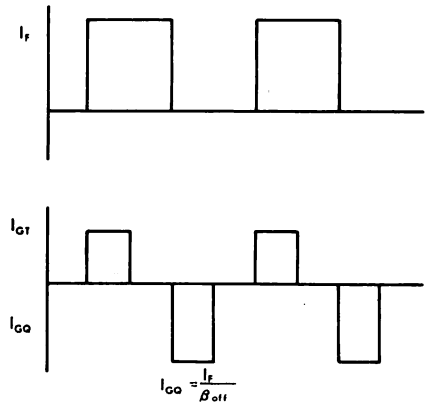

FIGURE 16



TYPICAL GATE-TURN - OFF CIRCUIT



TYPICAL WAVEFORMS

Improved turn-off time may be realized using the gate-turn-off method. A combination of gate-turn-off and standard commutating turn-off will further improve the turn-off time. For applications requiring a guaranteed β_{off} , contact your nearest TI Sales Office for information on special types.

TYPES 2N5273, 2N5274, 2N5275 SILICON BIDIRECTIONAL TRIODE THYRISTORS



FORMERLY L140A, L140B, L140C

- HIGH TEMPERATURE • HIGH CURRENT • HIGH VOLTAGE
- GATED, SYMMETRICAL SWITCHES
- 200, 400, AND 600 VOLTS
- 25 AMPS RMS

description

The 2N5273 through 2N5275 are bidirectional triode thyristors (triacs) which may be triggered from the off-state to the on-state by either polarity of gate signal with Main Terminal 2 positive, or by a negative gate signal with Main Terminal 2 negative.

*mechanical data

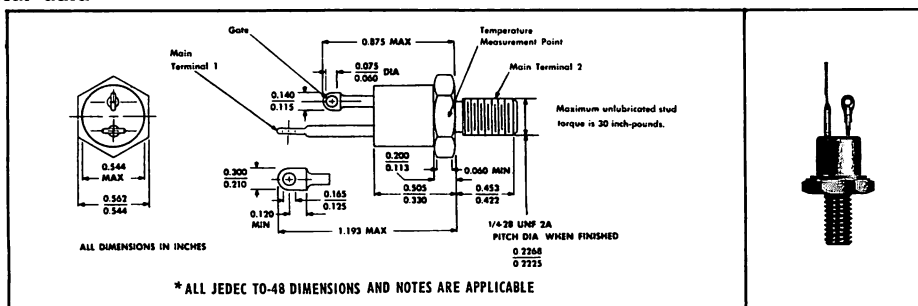

*absolute maximum ratings over operating case temperature range (unless otherwise noted)

	2N5273	2N5274	2N5275	UNIT
Continuous Off-State Voltage, V_D (See Note 1)	200	400	600	V
Repetitive Peak Off-State Voltage, V_{DRM} (See Note 1)	200	400	600	V
Full-Cycle RMS On-State Current at (or below) 60°C Case Temperature, $I_{T(rms)}$ (See Note 2)	25			A
Peak On-State Surge Current, I_{TSM} (See Note 3)	400			A
Peak Gate Voltage, V_{GM}	±10			V
Peak Gate Current, I_{GM}	±2			A
Peak Gate Power Dissipation, P_{GM} , at (or below) 60°C Case Temperature (Pulse Width ≤ 200 μs)	10			W
Average Gate Power Dissipation, $P_{G(av)}$, at (or below) 60°C Case Temperature (See Note 4)	2			W
Operating Case Temperature Range	-40 to 125			°C
Storage Temperature Range	-65 to 150			°C
Terminal Temperature 1/8 Inch from Case for 10 Seconds	260			°C

- NOTES: 1. These values apply bidirectionally when the resistance between the gate and Main Terminal 1, R_{G1} , ≤ ∞.
 2. This value applies for 50-Hz to 60-Hz full-sine-wave operation with resistive load. Above 60°C derate according to figure 2.
 3. This value applies for one 60-Hz full sine wave when the device is operating at (or below) the rated value of on-state current. Surge may be repeated after the device has returned to original thermal equilibrium. During the surge, gate control may be lost.
 4. This value applies for a maximum averaging time of 16.6 ms.

*Indicates JEDEC registered data



TEXAS INSTRUMENTS
INCORPORATED
POST OFFICE BOX 5012 • DALLAS, TEXAS 75222

TYPES 2N5273, 2N5274, 2N5275

SILICON BIDIRECTIONAL TRIODE THYRISTORS

*electrical characteristics

PARAMETER	TEST CONDITIONS	TYPE	TYP	MAX	UNIT
I_{DRM} Repetitive Peak Off-State Current	$V_{DRM} = \pm 200$ V, $I_E = 0$, $T_C = 125^\circ\text{C}$	2N5273		± 1	mA
	$V_{DRM} = \pm 400$ V, $I_E = 0$, $T_C = 125^\circ\text{C}$	2N5274		± 1	
	$V_{DRM} = \pm 600$ V, $I_E = 0$, $T_C = 125^\circ\text{C}$	2N5275		± 1	
I_{GTM} Peak Gate Trigger Current	$V_{supply} = +12$ V†, $R_L = 10 \Omega$, $t_{p(g)} \geq 50 \mu\text{s}$, $T_C = -40^\circ\text{C}$	ALL		+150	mA
	$V_{supply} = +12$ V†, $R_L = 10 \Omega$, $t_{p(g)} \geq 50 \mu\text{s}$, $T_C = -40^\circ\text{C}$			-150	
	$V_{supply} = -12$ V†, $R_L = 10 \Omega$, $t_{p(g)} \geq 50 \mu\text{s}$, $T_C = -40^\circ\text{C}$			-150	
V_{GTM} Peak Gate Trigger Voltage	$V_{supply} = +12$ V†, $R_L = 10 \Omega$, $t_{p(g)} \geq 50 \mu\text{s}$, $T_C = -40^\circ\text{C}$	ALL		+3.5	V
	$V_{supply} = +12$ V†, $R_L = 10 \Omega$, $t_{p(g)} \geq 50 \mu\text{s}$, $T_C = -40^\circ\text{C}$			-3.5	
	$V_{supply} = -12$ V†, $R_L = 10 \Omega$, $t_{p(g)} \geq 50 \mu\text{s}$, $T_C = -40^\circ\text{C}$			-3.5	
I_H Holding Current	$V_{supply} = \pm 12$ V†, $I_E = 0$, Initiating $I_{TM} = \pm 500$ mA, $T_C = -40^\circ\text{C}$	ALL	± 12	± 100	mA
I_L Latching Current	$V_{supply} = \pm 12$ V†, See Note 5, $T_C = -40^\circ\text{C}$	ALL	± 23		mA
dV/dt Critical Rate of Rise of Off-State Voltage	$V_{DRM} = \pm 200$ V, $I_E = 0$, $T_C = 125^\circ\text{C}$	2N5273		300	V/ μs
	$V_{DRM} = \pm 400$ V, $I_E = 0$, $T_C = 125^\circ\text{C}$	2N5274		300	
	$V_{DRM} = \pm 600$ V, $I_E = 0$, $T_C = 125^\circ\text{C}$	2N5275		300	
V_{TM} Peak On-State Voltage	$I_{TM} = \pm 35$ A, $I_E = 150$ mA, See Note 6, $T_C = 25^\circ\text{C}$	ALL		± 1.7	V

†The supply voltage is called positive when it causes Main Terminal 2 to be positive with respect to Main Terminal 1.

NOTES: 5. The triacs are triggered by a 15-V (open-circuit amplitude) pulse supplied by a generator with the following characteristics: $R_G = 100 \Omega$, $t_p = 50 \mu\text{s}$, $t_r \leq 15$ ns, $t_f \leq 15$ ns, PRR = 1 kHz.

6. The initial instantaneous value is measured using pulse techniques. $t_p \leq 1$ ms, duty cycle $\leq 2\%$.

*thermal characteristics

PARAMETER	MAX	UNIT
θ_{J-C} Junction-to-Case Thermal Resistance	1.75	deg/W
θ_{J-A} Junction-to-Free-Air Thermal Resistance	50	

*Indicates JEDEC registered data (typical values excluded)

TYPES 2N5273, 2N5274, 2N5275 SILICON BIDIRECTIONAL TRIODE THYRISTORS

switching characteristics at 25°C case temperature (unless otherwise noted)

PARAMETER	TEST CONDITIONS	TYP	UNIT
t_{gt} Gate-Controlled Turn-On Time	$V_{supply} = 25\text{ V}$, $R_L = 25\ \Omega$, $R_{G(off)} = 60\ \Omega$, $V_{in} = 18\text{ V}$, See Figure 1	0.3	μs

PARAMETER MEASUREMENT INFORMATION

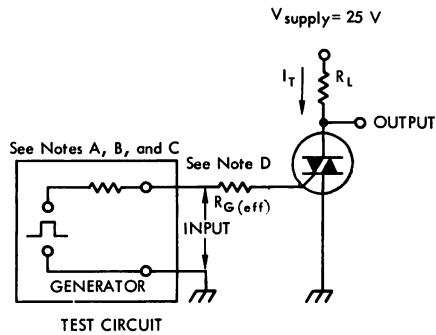
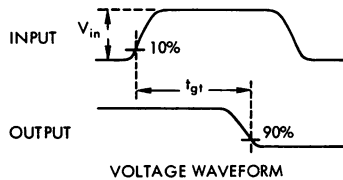

FIGURE 1 — GATE-CONTROLLED TURN-ON TIME

- NOTES:**
- A. V_{in} is measured with gate terminal open.
 - B. The input waveform of figure 1 has the following characteristics:
 $t_r \leq 40\text{ ns}$, $t_p \geq 20\ \mu\text{s}$.
 - C. Waveforms are monitored on an oscilloscope with the following characteristics: $t_r \leq 14\text{ ns}$, $R_{in} \geq 10\text{ M}\Omega$, $C_{in} \leq 12\text{ pF}$.
 - D. $R_{G(off)}$ includes the total resistance of the generator and the external resistor.

TYPES 2N5273, 2N5274, 2N5275 SILICON BIDIRECTIONAL TRIODE THYRISTORS

THERMAL INFORMATION

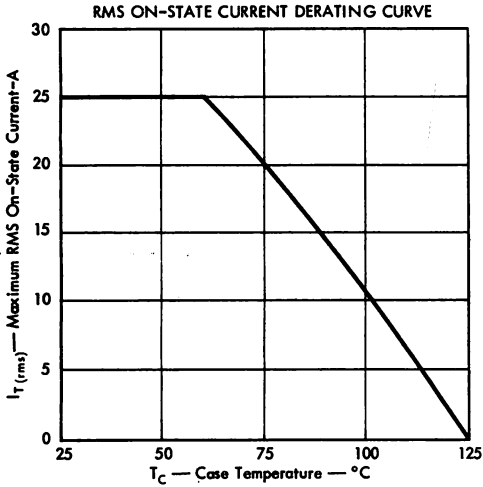

FIGURE 2

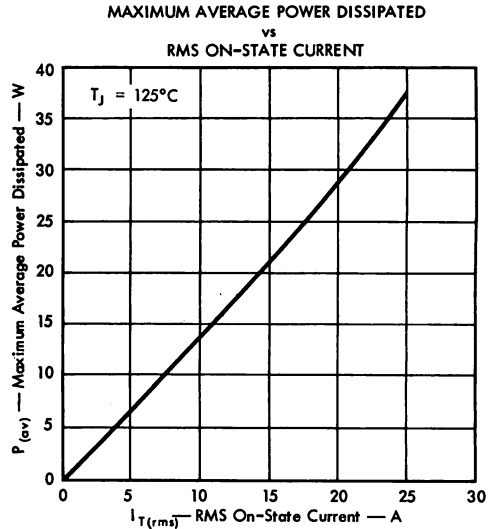

FIGURE 3

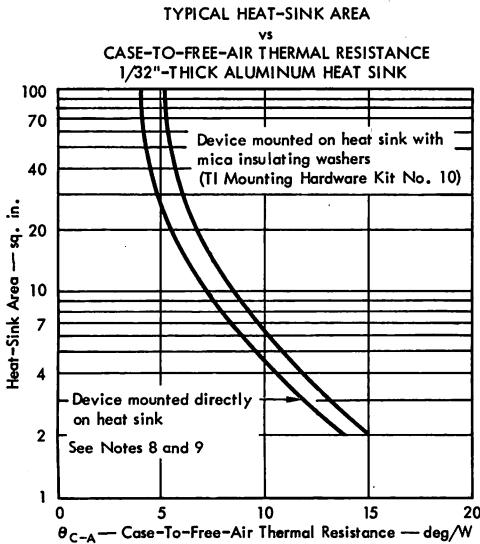

FIGURE 4

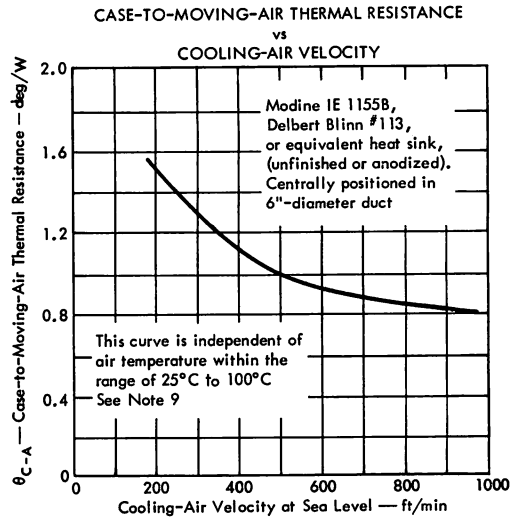

FIGURE 5

NOTES: 8. The thyristor is mounted in the center of a square heat sink vertically-positioned in still free air with both sides exposed. The heat-sink area is twice the area of one side.

9. θ_{C-A} includes the case-to-heat-sink thermal resistance, θ_{C-HS} , in addition to the heat-sink-to-air thermal resistance, θ_{HS-A} , and is defined by the equation $\theta_{C-A} = \theta_{C-HS} + \theta_{HS-A}$.

TYPES 2N5273, 2N5274, 2N5275 SILICON BIDIRECTIONAL TRIODE THYRISTORS

THERMAL INFORMATION

The minimum heat-sink requirements may be calculated for any on-state current, heat-sink combination by the following procedure:

1. Determine worst-case power dissipation from figure 3.
2. Calculate maximum allowable case-to-free-air thermal resistance by use of the equation:

$$\theta_{C-A} = \frac{T_J - T_A}{P_{(av)}} - \theta_{J-C}$$

- where: T_J = Junction temperature
 T_A = Free-air temperature
 $P_{(av)}$ = Average power dissipation
 (see figure 3 for worst-case values)
 θ_{J-C} = Junction-to-case thermal resistance = 1.75 deg/W maximum.

3. If possible, determine area of heat sink from figure 4. If figure 4 cannot be used, a forced-air-cooling heat-sink system must be used, see figure 5.

EXAMPLE NO. 1

Determine minimum size of 1/32"-thick aluminum heat sink for safe operation of the thyristor at an rms current of 10 A, with device mounted directly on heat sink.

- Given: Maximum $T_J = 125^\circ\text{C}$
 $T_A = 35^\circ\text{C}$
 $\theta_{J-C} = 1.75 \text{ deg/W}$

Solution: From figure 3, $P_{(av)} = 13 \text{ W}$ for 10 A rms. Using the equation of step 2 above:

$$\theta_{C-A} = \frac{125^\circ\text{C} - 35^\circ\text{C}}{13 \text{ W}} - 1.75 \text{ deg/W} = 5.1 \text{ deg/W}$$

Figure 4 is applicable and shows that for θ_{C-A} of 5.1 deg/W, the area is 24 sq. in. The minimum dimensions of the sides should be:

$$\sqrt{\frac{\text{area}}{2}} \times \sqrt{\frac{\text{area}}{2}} = \sqrt{\frac{24}{2}} \times \sqrt{\frac{24}{2}} = 3.5'' \times 3.5''$$

EXAMPLE NO. 2

Determine minimum heat sink requirements for safe operation of the thyristor at an rms current of 25 A.

- Given: Maximum $T_J = 125^\circ\text{C}$
 $T_A = 25^\circ\text{C}$
 $\theta_{J-C} = 1.75 \text{ deg/W}$

Solution: From figure 5, $P_{(av)} = 37.5 \text{ W}$ for 25 A rms. Using the equation of step 2 above:

$$\theta_{C-A} = \frac{125^\circ\text{C} - 25^\circ\text{C}}{37.5 \text{ W}} - 1.75 \text{ deg/W} = 0.92 \text{ deg/W}$$

Figure 5 is applicable and shows for $\theta_{C-A} = 0.92 \text{ deg/W}$, a Modine IE 1155B, Delbert Blinn #113 or equivalent heat sink should be used and be cooled by an air velocity of 630 ft/min.

TYPES 2N5273, 2N5274, 2N5275 SILICON BIDIRECTIONAL TRIODE THYRISTORS

TYPICAL CHARACTERISTICS

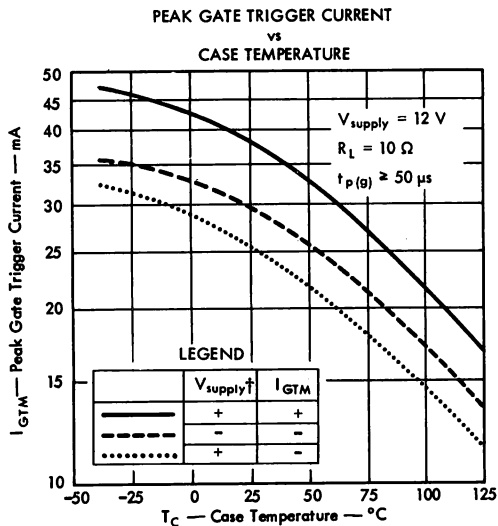

FIGURE 6

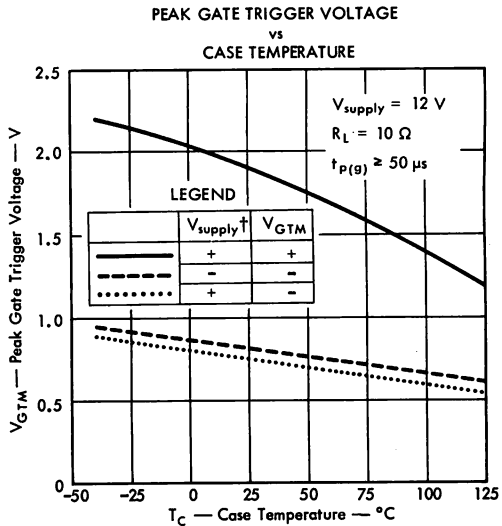

FIGURE 7

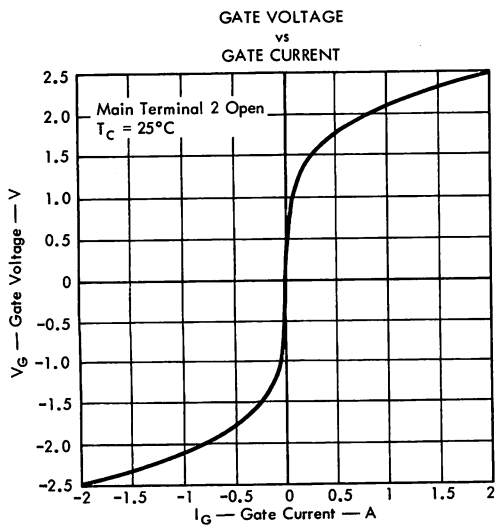

FIGURE 8

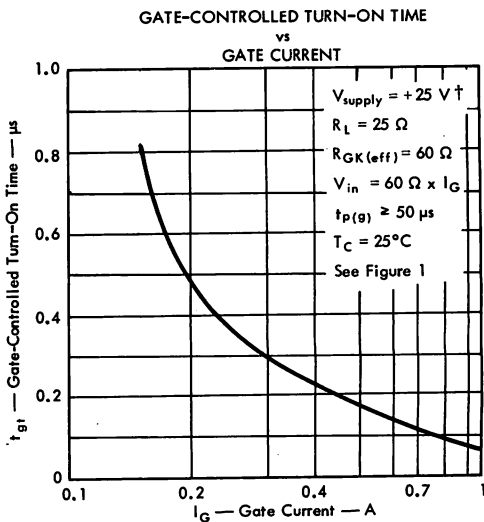

FIGURE 9

† The supply voltage is called positive when it causes Main Terminal 2 to be positive with respect to Main Terminal 1.

TYPES 2N5273, 2N5274, 2N5275 SILICON BIDIRECTIONAL TRIODE THYRISTORS

TYPICAL CHARACTERISTICS

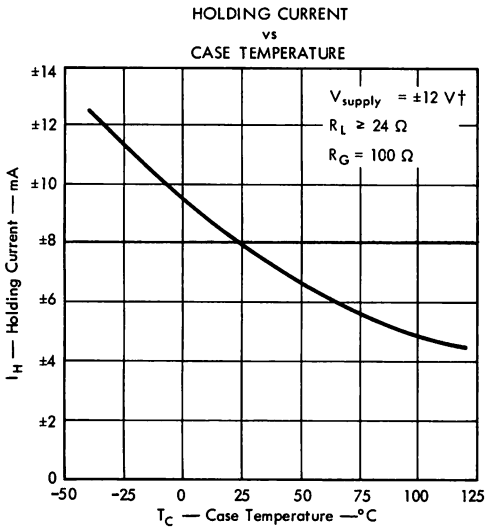

FIGURE 10

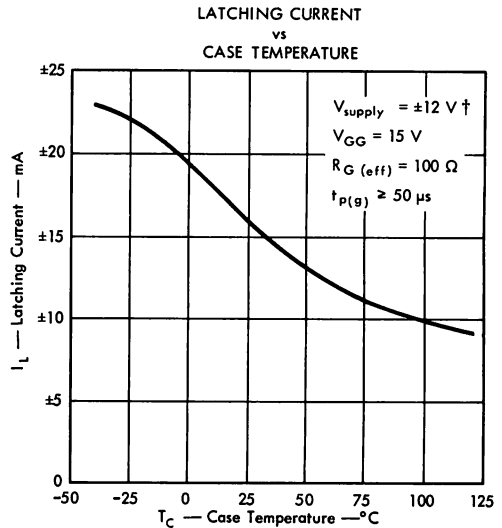

FIGURE 11

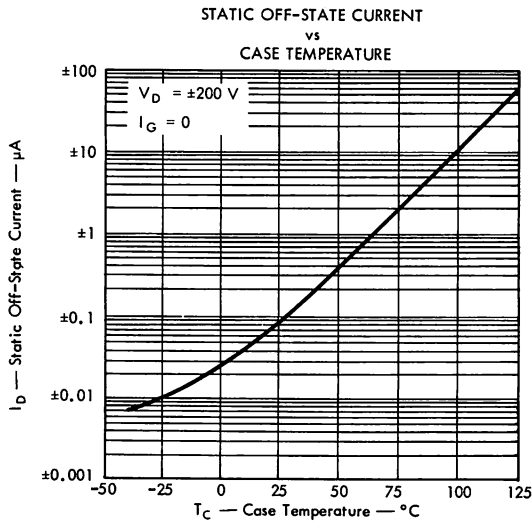

FIGURE 12

†The supply voltage is called positive when it causes Main Terminal 2 to be positive with respect to Main Terminal 1.

TYPES 2N5273, 2N5274, 2N5275 SILICON BIDIRECTIONAL TRIODE THYRISTORS

TYPICAL CHARACTERISTICS

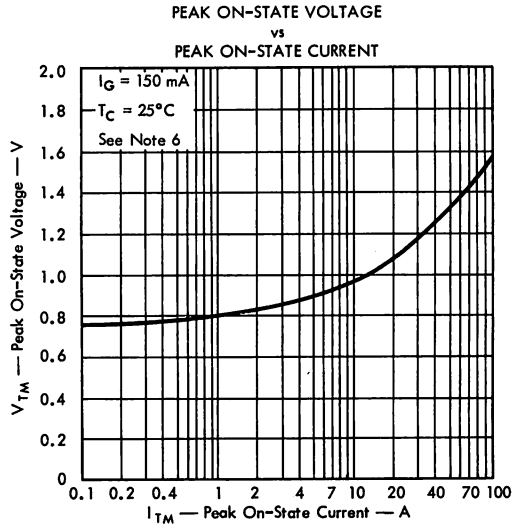
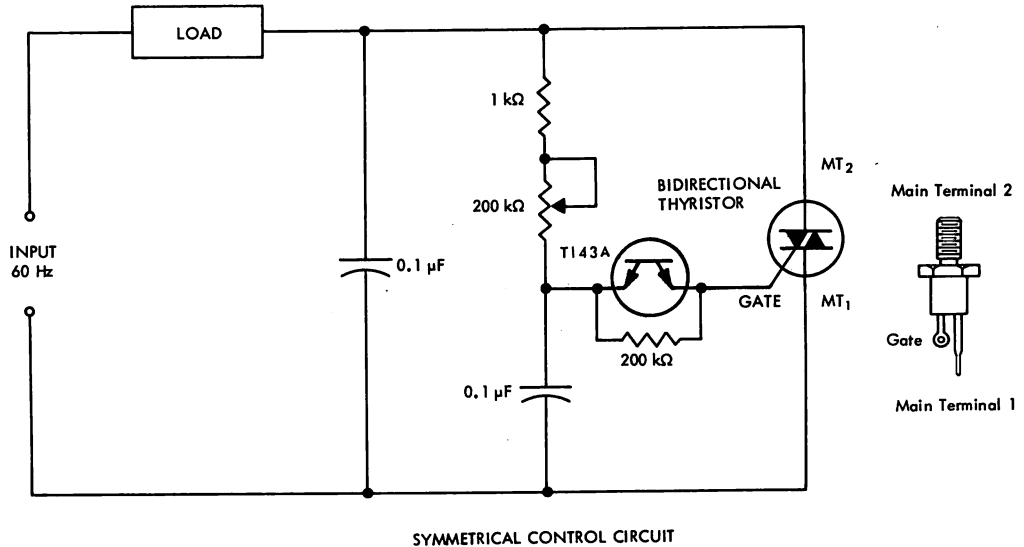

FIGURE 13

NOTE 6: The initial instantaneous value is measured using pulse techniques. $t_p \leq 1 \text{ ms}$, duty cycle $\leq 2\%$.

TYPICAL APPLICATION DATA



TYPES 2N5273, 2N5274, 2N5275 SILICON BIDIRECTIONAL TRIODE THYRISTORS

TYPICAL APPLICATION DATA

LOW POWER CONTROLS FOR HEAVY LOADS USING 25-A TRIAC

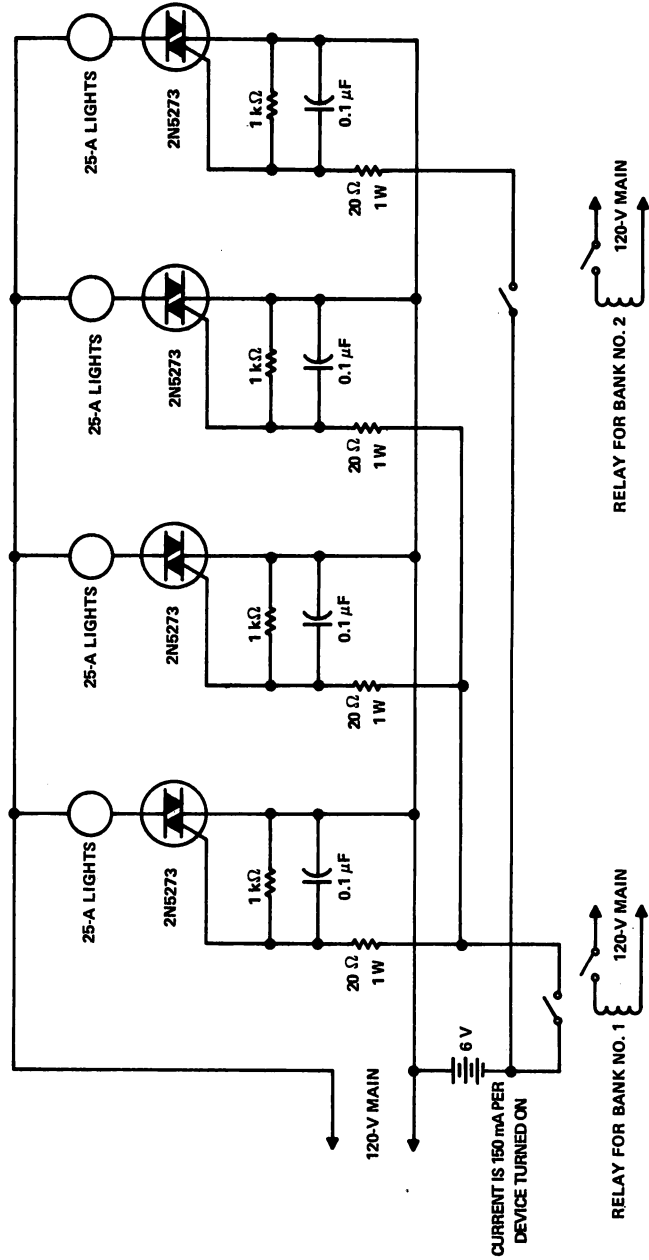

C-A17112

TI Microlibrary Books for Creative Circuit Designers



TRANSISTOR CIRCUIT DESIGN

523 Pages • 526 Illustrations • Published January '63 •
Shipping Weight 3-lb 4 oz • \$15.00

FIELD-EFFECT TRANSISTORS • L. J. SEVIN

138 Pages • 137 Illustrations • Published April '65 •
Shipping Weight 1-lb 10-oz • \$10.00

MOSFET IN CIRCUIT DESIGN • ROBERT H. CRAWFORD

136 Pages • 100 Illustrations • Published May '67 •
Shipping Weight 1-lb 10-oz • \$10.00

CIRCUIT DESIGN FOR AUDIO, AM/FM AND TV

352 Pages • 145 Illustrations • Published February '67 •
Shipping Weight 2-lb 8-oz • \$14.50

SILICON SEMICONDUCTOR TECHNOLOGY • W. R. RUNYAN

256 Pages • 301 Illustrations • Published May '65 •
Shipping Weight 2-lb 9-oz • \$16.50

DESIGN AND APPLICATION OF TRANSISTOR SWITCHING CIRCUITS • LOUIS DELHOM

278 Pages • 315 Illustrations • Published January '68 •
Shipping Weight 2-lb • \$14.50

SOLID STATE COMMUNICATIONS

366 Pages • 417 Illustrations • Published April '66 •
Shipping Weight 2-lb 9-oz • \$12.50

SOLID STATE ELECTRONICS • ROBERT G. HIBBERD

170 Pages • 90 Illustrations • Published January '68 •
Shipping Weight 1-lb 12-oz • \$8.95

Terms: F.O.B. destination, bulk rate.

Other than bulk rate,
indicate method of shipment,
add shipping charges.

Outside U.S.: Indicate method of shipment,
add shipping charges.

Send check or money order
(no purchase orders) to:

EXECUTIVE SERVICES DISTRIBUTION
Suite 148
8383 Stemmons Freeway
Dallas, Texas 75247

TYPES 1N4001 THROUGH 1N4007 DIFFUSED-JUNCTION SILICON RECTIFIERS



50-1000 VOLTS • 1 AMP AVG

- MINIATURE MOLDED PACKAGE
- INSULATED CASE
- IDEAL FOR HIGH-DENSITY CIRCUITRY

TYPES 1N4001 THROUGH 1N4007
BULLETIN NO. DL-5 637366, FEBRUARY 1965

*mechanical data

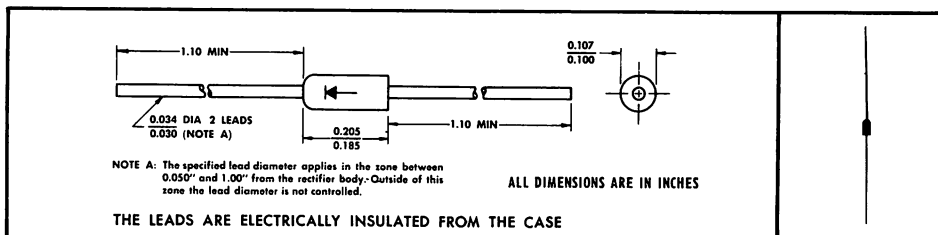

*absolute maximum ratings at specified ambient† temperature

	1N4001	1N4002	1N4003	1N4004	1N4005	1N4006	1N4007	UNIT
V_{RM}	Peak Reverse Voltage from -65°C to +175°C (See Note 1)							
	50	100	200	400	600	800	1000	v
V_R	Steady State Reverse Voltage from 25°C to 75°C							
	50	100	200	400	600	800	1000	v
I_O	Average Rectified Forward Current from 25°C to 75°C (See Notes 1 and 2)							
				1				a
$I_{FM(rep)}$	Repetitive Peak Forward Current, 10 cycles, at (or below) 75°C (See Note 3)							
				10				a
$I_{FM(surge)}$	Peak Surge Current, One Cycle, at (or below) 75°C (See Note 3)							
				30				a
$T_{A(opr)}$	Operating Ambient Temperature Range							
				-65 to +175				°C
T_{stg}	Storage Temperature Range							
				-65 to +200				°C
	Lead Temperature $\frac{3}{8}$ Inch from Case for 10 Seconds							
				350				°C

NOTES: 1. These values may be applied continuously under single-phase, 60-cps, half-sine-wave operation with resistive load. Above 75°C derate I_O according to Figure 1.

2. This rectifier is a lead-conduction-cooled device. At (or above) ambient temperatures of 75°C, the lead temperature $\frac{3}{8}$ inch from case must be no higher than 5°C above the ambient temperature for these ratings to apply.

3. These values apply for 60-cps half sine waves when the device is operating at (or below) rated values of peak reverse voltage and average rectified forward current. Surge may be repeated after the device has returned to original thermal equilibrium.

* Indicates JEDEC registered data.

† The ambient temperature is measured at a point 2 inches below the device. Natural air cooling shall be used.



TEXAS INSTRUMENTS
INCORPORATED
POST OFFICE BOX 5012 • DALLAS, TEXAS 75222

TYPES 1N4001 THROUGH 1N4007 DIFFUSED-JUNCTION SILICON RECTIFIERS

*electrical characteristics at specified ambient† temperature

PARAMETER		TEST CONDITIONS	MAX	UNIT
I_R	Static Reverse Current	$V_R = \text{Rated } V_R, T_A = 25^\circ\text{C}$	10	μa
		$V_R = \text{Rated } V_R, T_A = 100^\circ\text{C}$	50	μa
$I_{R(\text{avg})}$	Average Reverse Current	$V_{RM} = \text{Rated } V_{RM}, I_O = 1 \text{ a},$ $f = 60 \text{ cps}, T_A = 75^\circ\text{C}$	30	μa
V_F	Static Forward Voltage	$I_F = 1 \text{ a}, T_A = 25^\circ\text{C to } 75^\circ\text{C}$	1.1	v
$V_{F(\text{avg})}$	Average Forward Voltage	$V_{RM} = \text{Rated } V_{RM}, I_O = 1 \text{ a},$ $f = 60 \text{ cps}, T_A = 25^\circ\text{C to } 75^\circ\text{C}$	0.8	v
V_{FM}	Peak Forward Voltage	$V_{RM} = \text{Rated } V_{RM}, I_O = 1 \text{ a},$ $f = 60 \text{ cps}, T_A = 25^\circ\text{C to } 75^\circ\text{C}$	1.6	v

†Indicates JEDEC registered data.

THERMAL INFORMATION

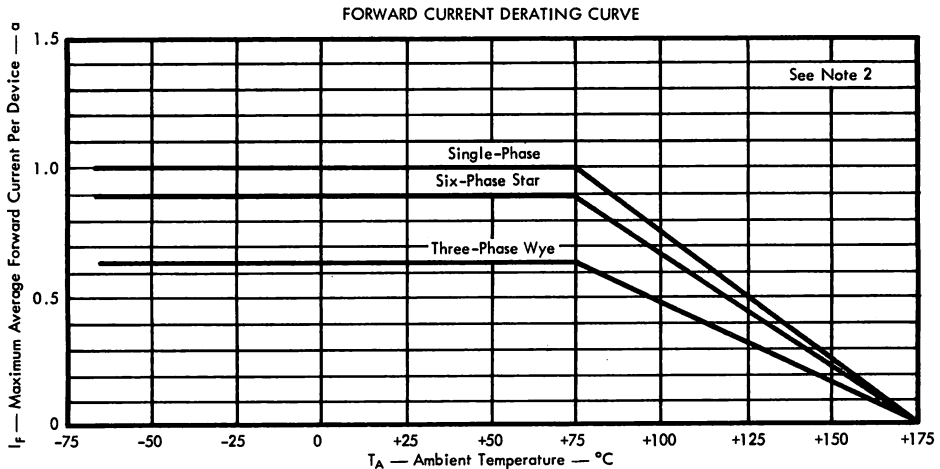

FIGURE 1

† The ambient temperature is measured at a point 2 inches below the device. Natural air cooling shall be used.

NOTE 2: This rectifier is a lead-conduction-cooled device. At (or above) ambient temperatures of 75°C , the lead temperature $\frac{3}{8}$ inch from case must be no higher than 5°C above the ambient temperature for these ratings to apply.

TYPE LS 400 N-P-N PLANAR SILICON PHOTO DEVICE



For Application in:
Character Recognition,
Tape Read-out, Photo Switching,
Proportional Control,
Differential Amplifiers

30 VOLTS 50 MILLIWATTS
Operation to 125° C
Designed for High Sensitivity,
Fast Response

TYPE LS 400
 BULLETIN NO. DL-5, 682721, JUNE 1962
 REVISED MAY 1968

mechanical data

Hard glass, hermetically sealed case. Unit weight 0.1 gram.

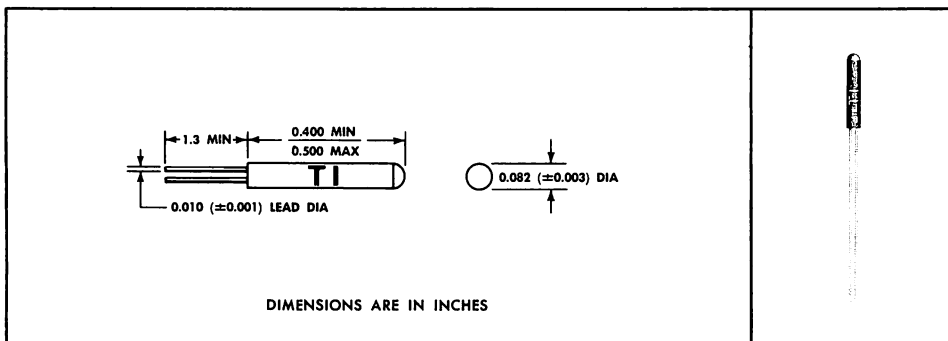

ratings — conditions at 25°C (unless otherwise noted)

	symbol	min	typical	max	unit
Power dissipation	P			50	mw
Reverse voltage	V _R			30	v
Operating temperature	T _A			125	°C
Forward breakdown @ 100 μa	BV _F		8		v
Reverse breakdown @ 100 μa	BV _R		50		v

electrical specifications

Light current @ 5 v *	I _L	1.0	3.0		ma
Dark current @ 30 v	I _d		0.01	0.025	μa
Dark current @ 30 v @ 125°C	I _d		10		μa
Rise time**	t _r		1.5		μs
Fall time**	t _f		15		μs
Light current sensitivity between 300 and 600 foot candles @ 5 v			7		μa/foot candle

*Measured with radiation of 9 mw/cm² in wavelengths from 0.7 to 1.0 microns.
 **Measured with 1000 ohm series resistance in wavelengths from 0.7 to 1.0 microns.



TYPE LS400 N-P-N PLANAR SILICON PHOTO DEVICE

TYPICAL APPLICATION DATA

LIGHT-PULSE-DURATION INDICATOR

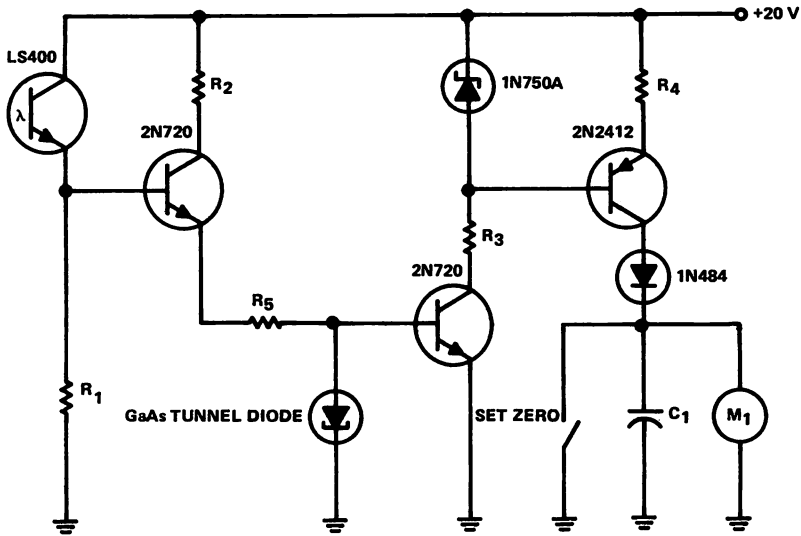

CA17113

TIME IN SECONDS EQUALS ONE TENTH OF VOLTMETER READING IN VOLTS.

TYPICAL PERFORMANCE

Maximum Pulse Width	1 s
Minimum Pulse Width	1 μ s
Operating Temperature Range	0°C to 70°C

CIRCUIT COMPONENT INFORMATION

- R₁: 4.7 k Ω
- R₂: 1 k Ω
- R₃: 1.5 k Ω
- R₄: 3.6 k Ω
- R₅: 500 Ω
- C₁: 100 μ F, Mylar[†]
- M₁: VTVM, 10-M Ω input impedance

[†]Trademark of E. I. duPont

TYPE LS 600
 BULLETIN NO. DI-S-633820, JUNE 1963
 REVISED OCTOBER 1965

**MICRO SENSOR DESIGNED FOR
HIGH-DENSITY MATRIX AND
LINE READ-OUT EQUIPMENT**

- Recommended for Application in Character Recognition, Tape and Card Readers, Velocity Indicators, and Encoders
- Unique Package Design Allows for Assembly into Printed Circuit Boards
- Small Diameter Reduces Optical "Cross-Talk"
- Power Dissipation 50 mw

mechanical data

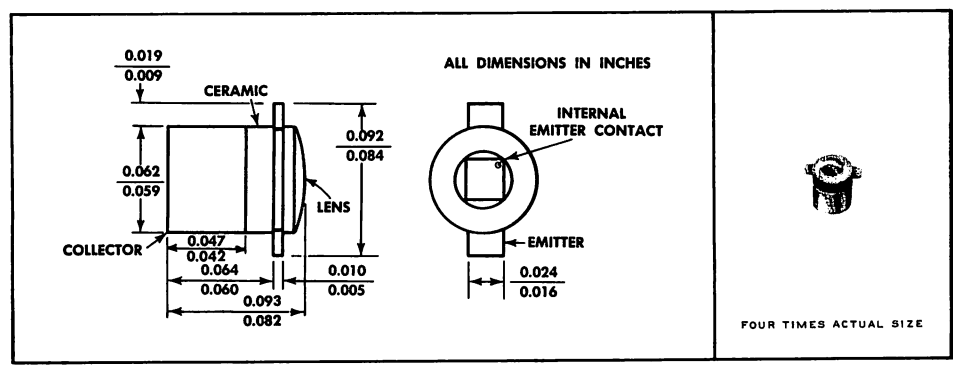

absolute maximum ratings at 25°C free-air temperature (unless otherwise noted)

Collector-Emitter Voltage	50 v
Emitter-Collector Voltage	7 v
Total Device Dissipation at (or below) 25°C Free-Air Temperature (See Note 1)	50 mw
Operating Free-Air Temperature Range	-65°C to +125°C
Storage Temperature Range	-65°C to +150°C
Soldering Temperature (3 minutes)	240°C

NOTE 1: Derate linearly to 125°C free-air temperature at the rate of 0.5 mw/°C

TYPE LS 600 N-P-N PLANAR SILICON LIGHT SENSOR

electrical characteristics at 25°C free-air temperature (unless otherwise noted)

PARAMETER	TEST CONDITIONS	MIN	TYP	MAX	UNIT
I_L Light Current	$V_{CE} = 5 \text{ v}$, $H = 20 \text{ mw/cm}^2$ (See Note 2)	0.8	1.0		ma
I_D Dark Current	$V_{CE} = 30 \text{ v}$, $H = 0$		0.01	0.025	μa
I_D Dark Current	$V_{CE} = 30 \text{ v}$, $H = 0$ $T_A = 100^\circ\text{C}$		10		μa
$V_{CE(sat)}$ Collector-Emitter Saturation Voltage	$I_L = 0.4 \text{ ma}$, $H = 20 \text{ mw/cm}^2$ (See Note 2)		0.3		v

NOTE 2. Irradiance (H) is the radiant power per unit area incident upon a surface. For this measurement the source is an unfiltered tungsten linear filament bulb operating at a 2870°K color temperature.

switching characteristics at 25°C free-air temperature

PARAMETER	TEST CONDITIONS	TYP	UNIT
t_r Rise Time	$V_{CC} = 35 \text{ v}$, $I_L = 800 \mu\text{a}$ $R_L = 1 \text{ k}\Omega$, (See Figure 1)	1.5	μsec
t_f Fall Time		15	μsec

PARAMETER MEASUREMENT INFORMATION

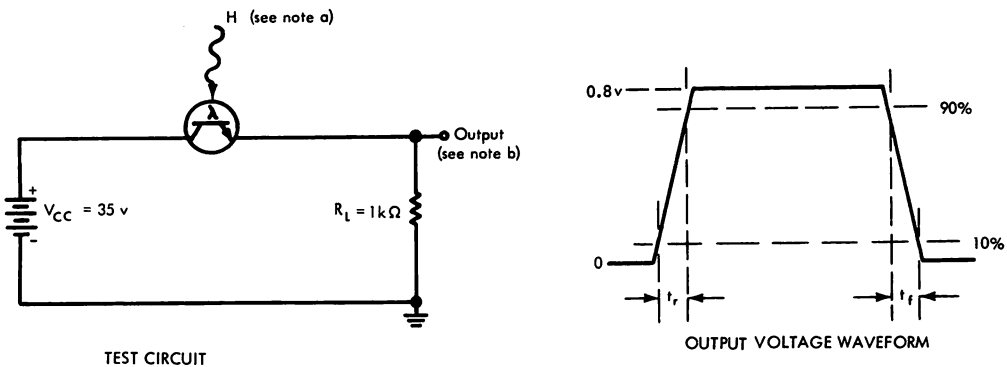

FIGURE 1

NOTES: a. Input irradiance is supplied by a pulsed xenon bulb source. Incident irradiation is adjusted for $I_L = 800 \mu\text{a}$.

b. Output waveform is monitored on an oscilloscope with the following characteristics:

$$t_r \leq 12 \text{ nsec}; R_{in} \geq 1 \text{ megohm}, C_{in} \leq 20 \text{ pf.}$$

TYPE 1N2175 N-P-N DIFFUSED SILICON PHOTO-DUO-DIODE



FOR APPLICATION IN:

Tape readout
Card readout
Light switching
Measurement indicators

50 VOLTS
250 MILLIWATTS
Designed for 125°C operation
Unlimited altitude range

TYPE 1N2175
BULLETIN NO. DL-S-62313, DECEMBER 1962
REPLACES BULLETIN NO. DL-S 1044, FEBRUARY 1959

mechanical data

Hermetically sealed case. Unit weight 0.16 gram.

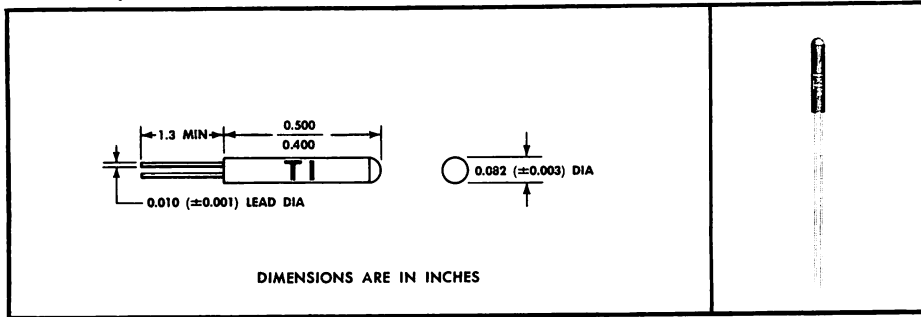

ratings

conditions	min	typical	max	unit
Bias Voltage @25°C			±50	v
Power Dissipation @25°C			250	mW
Operating Temperature	-65		125	°C
Storage Temperature	-65		125	°C
‡ Dark Current @25°C @ ±50 v		0.01	0.5	μA
‡ Dark Current @100°C @ ±50 v		20	100	μA
† Light Current @25°C @ ±10 v	100	200		μA
* Typical Photocurrent Rise Time		2		μs
Typical Photocurrent Fall Time		45		μs
Typical Sensitivity		22.3		μA/mW/cm ²

specifications

NOTES:

‡ Dark current is leakage current across diode with no incident irradiation.

† Light current is measured for a value of irradiance. Irradiance = 9 mw/cm² in a wave length range of .7 to 1.1 microns as defined by a Corning CS 7-69 filter.

* Rise time is the time required for the photocurrent ** to rise from 10% to 90% of its final value after instantaneous application of excitation. Fall time is the time for the photocurrent to decay from 90% to 10% of its initial value after instantaneous removal of excitation.

**Photocurrent is the difference between Light Current and Dark Current.

APPLICATION NOTES:

The 1N2175 is a subminiature symmetrically diffused silicon unit. The two junctions are symmetrical so either diode terminal can be biased positively or negatively. Because of this unique design, AC or DC bias voltage can be used. The small size and high light sensitivity of this unit makes it particularly useful in high speed reading of punched cards and tapes, light detection systems, and in production line screening or counting. Numerous other commercial and military applications exist.



TEXAS INSTRUMENTS
INCORPORATED
POST OFFICE BOX 5012 • DALLAS, TEXAS 75222

TYPE 1N2175 N-P-N DIFFUSED SILICON PHOTO-DUO-DIODE

TYPICAL CHARACTERISTICS

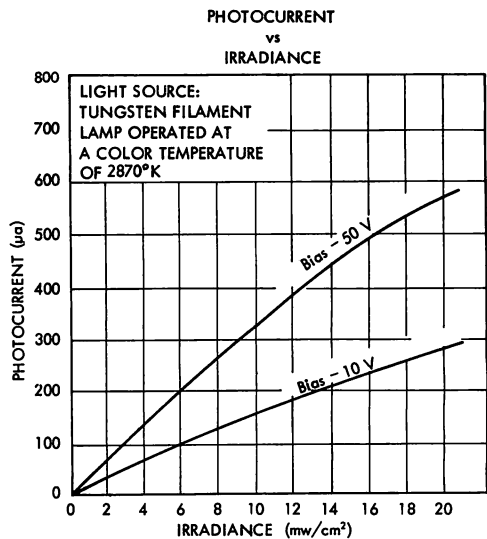
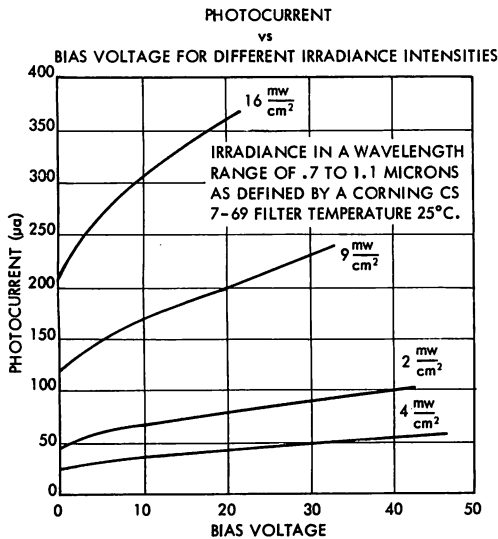
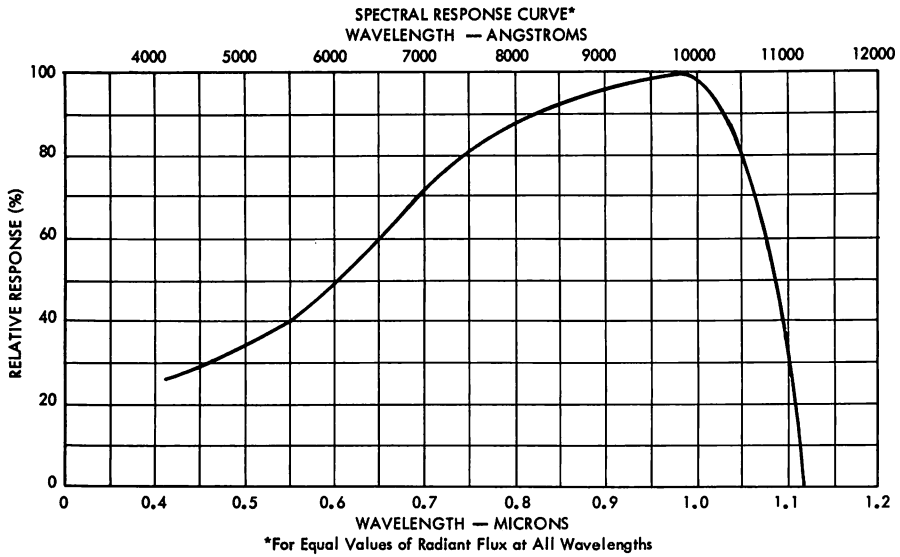

TYPE 1N2175 N-P-N DIFFUSED SILICON PHOTO-DUO-DIODE

TYPICAL CHARACTERISTICS

TYPICAL DARK CURRENT CHARACTERISTIC
vs TEMPERATURE
FOR ANY CONSTANT VOLTAGE
BETWEEN 10 AND 50 V

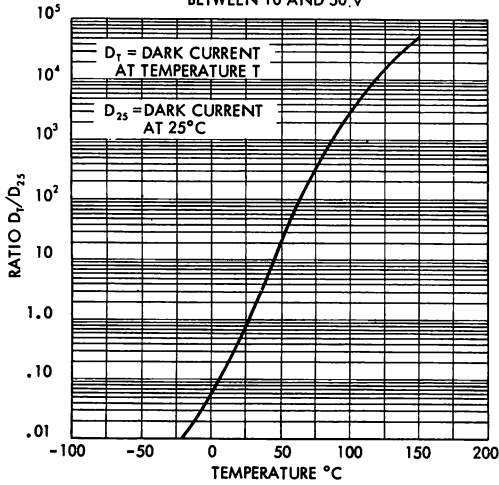

DERATING CURVE

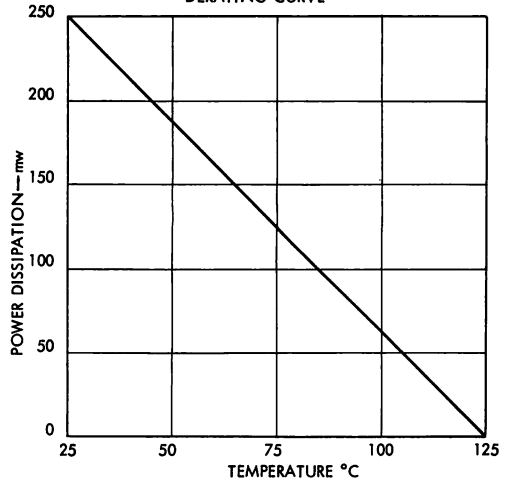

FREQUENCY RESPONSE AT BIAS VOLTAGE OF 10 V AND 25°C

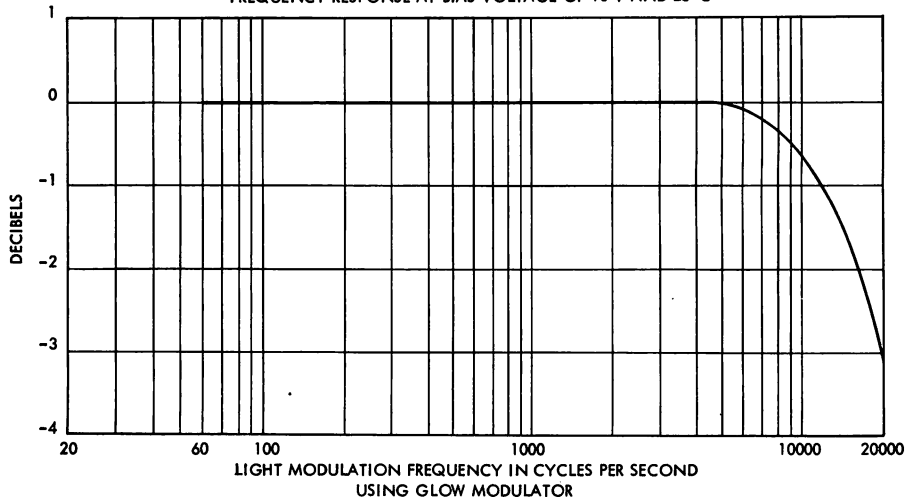

TYPE 1N2175 N-P-N DIFFUSED SILICON PHOTO-DUO-DIODE

TYPICAL APPLICATION DATA

PHOTO DUO-DIODE PREAMPLIFIER

This circuit was designed for use with the TI 1N2175 photo duo-diode. A voltage amplification of 30 db was obtained. This varied less than 1 db changing from low h_{FE} units at -40°C to high h_{FE} units at 100°C . An output of 4 volts peak to peak can be obtained across a $1\text{ k}\Omega$ load resistor. The amplifier response is ± 1 db from 10 cps to 10 kc.

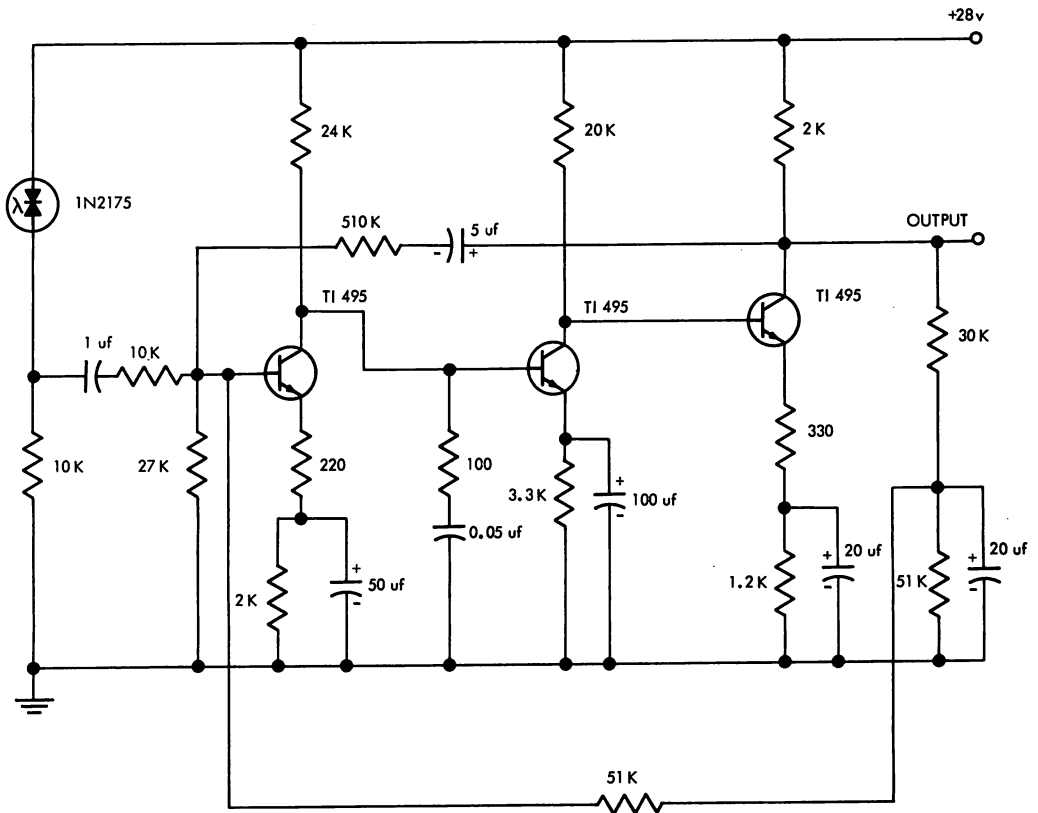

Resistor values are in ohms.

TYPE 1N2175 N-P-N DIFFUSED SILICON PHOTO-DUO-DIODE

TYPICAL APPLICATION DATA

LOW-NOISE PHOTODIODE PREAMPLIFIER

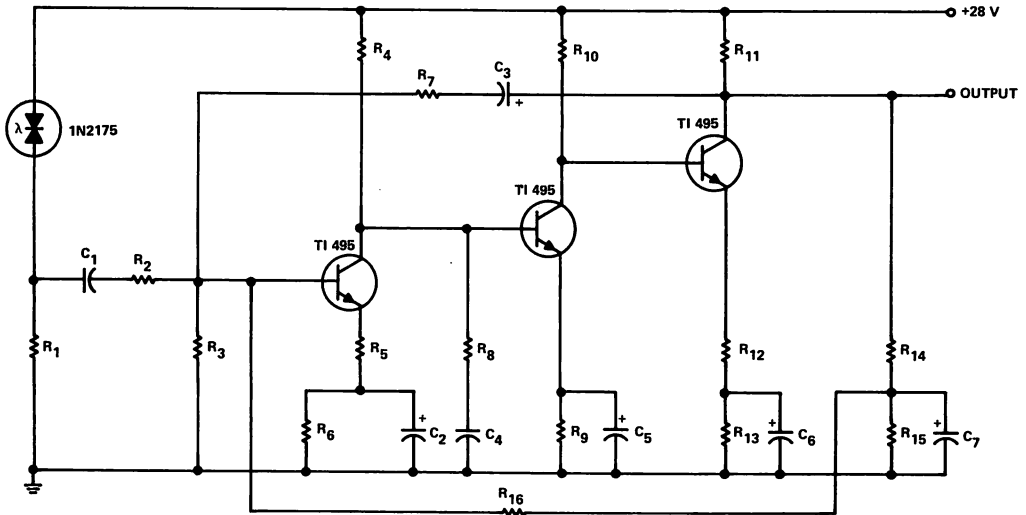

CA17114

CIRCUIT COMPONENT INFORMATION

RESISTORS

R_1 : 10 k Ω R_9 : 3,3 k Ω
 R_2 : 10 k Ω R_{10} : 20 k Ω
 R_3 : 27 k Ω R_{11} : 2 k Ω
 R_4 : 24 k Ω R_{12} : 330 Ω
 R_5 : 220 Ω R_{13} : 1,2 k Ω
 R_6 : 2 k Ω R_{14} : 30 k Ω
 R_7 : 510 Ω R_{15} : 51 k Ω
 R_8 : 100 Ω R_{16} : 51 k Ω

CAPACITORS

C_1 : 1 μ F
 C_2 : 50 μ F
 C_3 : 5 μ F
 C_4 : 0,05 μ F
 C_5 : 100 μ F
 C_6 : 20 μ F
 C_7 : 20 μ F

TYPICAL PERFORMANCE DATA

Voltage Gain	30 dB
Output Voltage	4 V
Frequency Response	1 Hz to 10 kHz
Operating Temperature Range	-40°C to 100°C

TI World-Wide Sales Offices

ALABAMA

Sahara Office Park Bldg., Suite 111
3313 Memorial Parkway, S.W.
Huntsville, Alabama 35801
205-881-4061

ARIZONA

2535 W. Camelback Rd., Suite 1D
Phoenix, Arizona 85017
602-279-5531

CALIFORNIA

1800 North Argyle Ave.
Hollywood, California 90028
213-466-7251

5005 West Century Blvd., Suite 208
Inglewood, California 90301
213-673-3943

230 California Ave., Suite 201
Palo Alto, California 94306
415-326-6770

1505 East 17th St., Suite 201
Santa Ana, California 92701
714-547-6506

4185 Adams Ave.
San Diego, California 92116
714-284-1181

COLORADO

2186 South Holly St., Suite 204
Denver, Colorado 80222
303-757-8548

CONNECTICUT

300 Amity Road
Woodbridge, Connecticut 06525
203-389-4521

FLORIDA

618 East South St., Suite 114
Orlando, Florida 32801
305-422-9894

ILLINOIS

Suite 205, Executive Towers
5901 N. Cicero Ave.
Chicago, Illinois 60646
312-286-1000

MASSACHUSETTS

60 Hickory Drive
Waltham, Mass. 02154
617-891-8450

MICHIGAN

Suite 706 West, Northland Towers Bldg.
15565 Northland Dr.
Southfield, Michigan 48075
313-357-1703

MINNESOTA

7615 Metro Blvd.
Suite 202, U.C.L.I. Bldg.
Edina, Minn. 55424
612-941-4384

NEW JERSEY

U.S. Highway #22
P.O. Box 366
Union, New Jersey 07083
201-687-7200

NEW YORK

P. O. Box 87, 2209 E. Main
Endicott, New York 13760
607-785-9987

4 Nevada Drive
New Hyde Park, N. Y. 11040
516-488-9894

131 Fulton Ave., Apt. J-2
Poughkeepsie, New York 12603
914-471-6095

6563 Ridings Rd.
Syracuse, New York 13206
315-463-9291

OHIO

22035 Chagrin Blvd.
Cleveland, Ohio 44122
216-751-2600

Suite 205, Paul Welch Bldg.
3300 South Dixie Dr.
Dayton, Ohio 45439
513-298-7513

PENNSYLVANIA

Benjamin Fox Pavilion
Suite 424, Foxcroft Square
Jenkintown, Pa. 19046
215-885-3454

TEXAS

MS80 — P.O. Box 5012
Dallas, Texas 75222
214-238-4861

3609 Buffalo Speedway
Houston, Texas 77006
713-526-3268

WASHINGTON

5801 Sixth Ave. S.
Seattle, Washington 98108
206-762-4240

WASHINGTON, D.C.

1875 Connecticut Ave., N.W., Suite 913
Washington, D.C. 20009
202-234-9320

CANADA

Geophysical Service Incorporated
280 Centre Str. East
Richmond Hills
Ontario, Canada
925-1035

663 Orly Avenue
Dorval
Quebec, Canada
631-6010

EUROPE

Texas Instruments Limited
Manton Lane
Bedford, England

Texas Instruments France S. A.
Boite Postale 5
Villeneuve-Loubet (A.M.), France

11 rue de Madrid
Paris 8^e, France

Texas Instruments Holland N.V.
Semiconductor Division
Enschedeestraat 19
Hengelo (Ov), Holland

Texas Instruments Italia S.p.A.
Via Colautti 1
Milan, Italy

Texas Instruments Incorporated
118 Rue du Rhone
1204 Geneva, Switzerland

Texas Instruments Sweden A.B.
Timmermansgatan 34, Box 17116
Stockholm 17, Sweden

Texas Instruments Deutschland GmbH
Hildesheimerstr. 19
3 Hannover, W. Germany

Texas Instruments Deutschland GmbH
Wolframstrasse 26
7 Stuttgart
West Germany

Texas Instruments Deutschland GmbH
Clemensstrasse 30
8 Munich 23
West Germany

Texas Instruments Deutschland GmbH
Kesperstrasse 33
805 Freising-Lerchenfeld
West Germany

Texas Instruments Deutschland GmbH
Koenigsbacherstrasse 22
6 Frankfurt, West Germany

MEXICO

Texas Instruments de Mexico S.A.
Poniente 116 #489
Col. Ind. Vallejo
Mexico 15, D.F.

ARGENTINA

Texas Instruments Argentina S.A.I.C.F.
(P. O. Box 2296 — Correo Central)
Ruta Panamericana Km. 13, 5
Don Torcuato
Buenos Aires, Argentina

BRAZIL

Texas Instrumentos Electronicos
do Brazil Ltda.
Rua Cesario Alvim 770
Caixa Postal 30.103
Sao Paulo 6, Brazil

AUSTRALIA

Texas Instruments Australia Ltd.
Box 63, Oldham Road
Elizabeth, South Australia

Texas Instruments Australia Ltd.
Room 5, Rural Bank Bldg.
Burwood, N.S.W., Australia

JAPAN

Texas Instruments Asia Limited
404 T.B.R. Building
No. 59, 2-chome, Nagata-cho
Chiyoda-du, Tokyo, Japan

TYPES CG $\frac{1}{8}$, CG $\frac{1}{4}$ AND CG $\frac{1}{2}$ PRECISION, CARBON-FILM, GLASS-ENCAPSULATED HERMETIC RESISTORS



- Proven high reliability — > 40,000,000 test data hours
- -65°C to 175°C storage temperature
- Hermetically sealed in hard glass
- Meet or exceed all requirements of Specification MIL-R-10509D for Characteristics B, D & G
- Leads welded to end caps
- $\pm 1\%$ ohmic tolerance

TYPES CG $\frac{1}{8}$, CG $\frac{1}{4}$, CG $\frac{1}{2}$
 BULLETIN NO. DI-5 634364, SEPTEMBER 1963
 REPLACES BULLETIN NO. DI-5 634364, MARCH 1963

environmental tests

To achieve maximum reliability, all TI glass resistors are 100% inspected for hermetic seal as a continuous process control. Tests are conducted to all electrical, environmental, and mechanical specifications to insure full and continuous compliance with Mil-R-10509D, Characteristics B,D, and G.

specifications

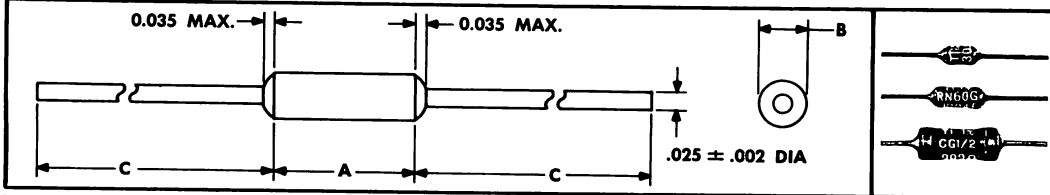

TI type number	wattage rating ($T_A \leq 70^\circ\text{C}$)*				MIL designation	standard resistance ranges	maximum working voltage**	body length*** (A)	body diameter (B)	lead length (C)	lead size	avg. weight per 100 unpacked units
	MIL											
	TI	B	D	G								
CG $\frac{1}{8}$	$\frac{1}{8}$	—	$\frac{1}{8}$	$\frac{1}{10}$	RN55	10 Ω to 100K Ω	250	0.240 (+.010 / -.020)	0.125 (± 0.015)	1.500 (± 0.125)	22	0.076
CG $\frac{1}{4}$	$\frac{1}{4}$	$\frac{1}{8}$	$\frac{1}{4}$	$\frac{1}{8}$	RN60	10 Ω to 1 Meg Ω	350	0.360 (+.025 / -.015)	0.140 (± 0.020)	1.500 (± 0.125)	22	0.09
CG $\frac{1}{2}$	$\frac{1}{2}$	$\frac{1}{4}$	$\frac{1}{2}$	$\frac{1}{4}$	RN65	10 Ω to 2 Meg Ω	500	0.560 ($\pm .025$)	0.225 (± 0.020)	1.500 (± 0.125)	22	0.228

*For operation at higher temperature, see Dissipation Derating Curves, Page 2.

**Critical ohmic value and above. For lower values use $E = \sqrt{PR}$. See Paragraph 3.6 of MIL-R-10509D

***Length of glass package. Fillets on leads extend 0.035" max. beyond glass.

symbolization

CG $\frac{1}{8}$ — Standard stock symbolization includes manufacturer's identification, tolerance and ohmic value (e.g. — TI, 1%, 100 K).

CG $\frac{1}{4}$ — Standard stock symbolization includes manufacturer's identification, tolerance, mil-type designation and ohmic value (e.g. — TI, 1%, RN60G, 1003F, 100 K).

CG $\frac{1}{2}$ — Standard stock symbolization includes manufacturer's identification, tolerance, mil-type designation and ohmic value (e.g. — TI, 1%, RN65G, 1003F, 100 K).

modifications available on request

- $\pm 1\%$, 2% or 5% Resistance Tolerance
- Resistance Values Outside Published Ranges
- Special symbolization

performance characteristics †

- Temperature Cycling per MIL-R-10509D (4.6.4)
- Low Temperature Operation per MIL-R-10509D (4.6.5)
- Short Time Overload per MIL-R-10509D (4.6.6)
- Effect of Soldering per MIL-R-10509D (4.6.10)
- Insulation Resistance per MIL-R-10509D (4.6.9)
- Moisture Resistance per MIL-R-10509D (4.6.11)
- Shock per MIL-R-10509D (4.6.15)
- Vibration, High Frequency per MIL-R-10509D (4.6.16)
- Shelf Life, Change per Year
- Voltage Coefficient

average performance of TI CG $\frac{1}{4}$ resistors

- less than $\pm 0.05\%$
- less than $\pm 0.05\%$
- less than $\pm 0.05\%$
- less than $\pm 0.03\%$
- greater than 1,000,000 megohms
- less than $\pm 0.08\%$
- less than $\pm 0.05\%$
- less than $\pm 0.05\%$
- less than $\pm 0.04\%$
- less than 0.002%/volt

limits

MIL Char D	TI and MIL Char G
$\pm 0.50\%$	$\pm 0.25\%$
$\pm 0.50\%$	$\pm 0.25\%$
$\pm 0.50\%$	$\pm 0.25\%$
$\pm 0.50\%$	$\pm 0.10\%$
greater than 10,000 megohms	greater than 10,000 megohms
$\pm 1.50\%$	$\pm 0.50\%$
$\pm 0.50\%$	$\pm 0.25\%$
$\pm 0.50\%$	$\pm 0.25\%$
no requirement	no requirement
no requirement	no requirement

†Unless otherwise noted, data is % change in initial resistance. The two-sigma limits were used as the range indications for average performance.



TEXAS INSTRUMENTS
INCORPORATED
POST OFFICE BOX 5012 • DALLAS, TEXAS 75222

TYPES CG $\frac{1}{8}$, CG $\frac{1}{4}$ AND CG $\frac{1}{2}$ PRECISION, CARBON-FILM, GLASS-ENCAPSULATED HERMETIC RESISTORS

THERMAL INFORMATION DISSIPATION DERATING CURVES

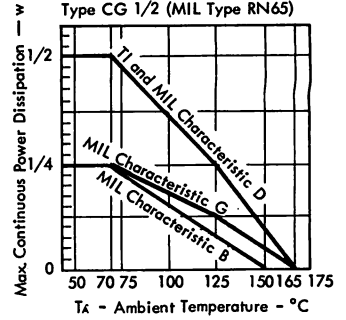
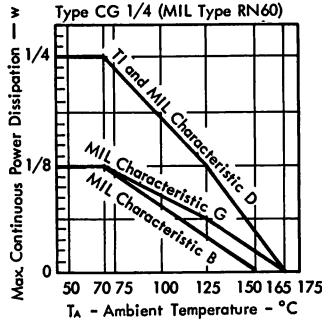
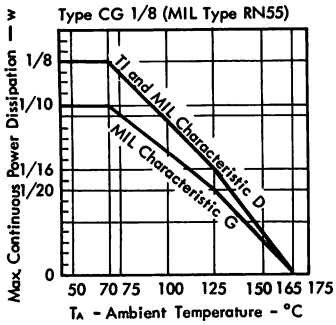

TYPICAL CHARACTERISTICS

TEMPERATURE COEFFICIENT vs RESISTANCE

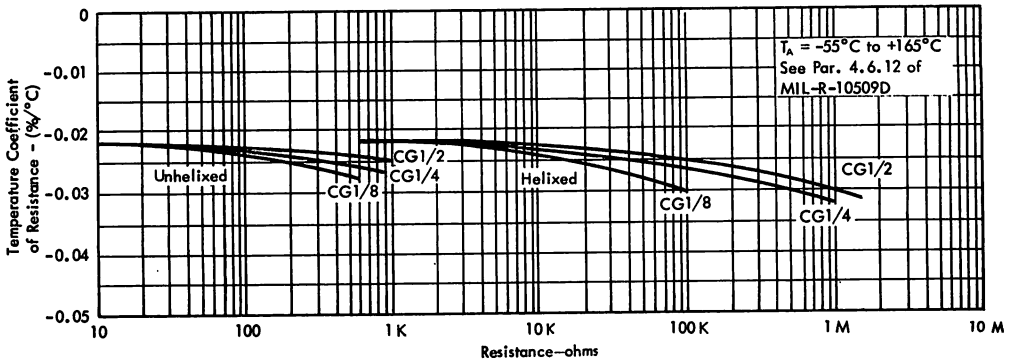

LOAD LIFE PERCENT CHANGE vs TIME

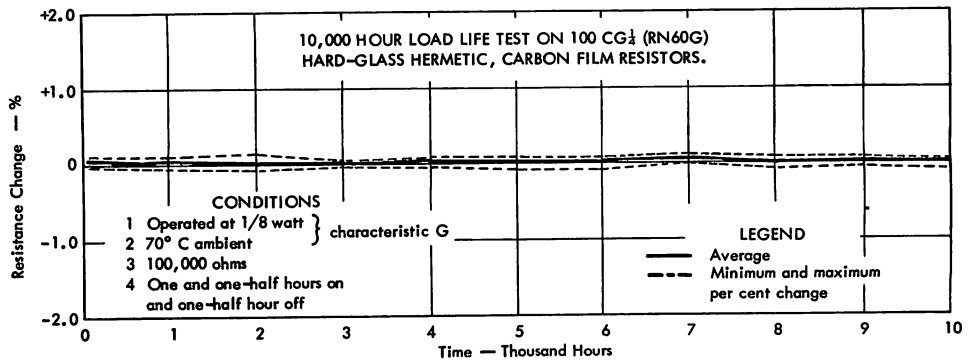

TYPES MC55, MC60, MC65, MC55D, MC60D, MC65D EPOXY-ENCAPSULATED PRECISION METAL-FILM RESISTORS



TYPES MC55, MC60, MC65, MC55D, MC60D, MC65D
 BULLETIN NO. DL-5 685630, JULY 1964
 REVISED MAY 1968

Designed to meet or exceed all requirements of
Specification MIL-R-10509F for Characteristic C, D, E, & F.

- Load-rated for 125°C or 70°C applications
- High degree of stability and reliability
- Precision resistance tolerances
- Rugged cap-and-lead construction
- Temperature Coefficients ± 10 , ± 25 , ± 50 and ± 100 ppm/°C
- Tough Epoxy coating • Fully insulated

specifications

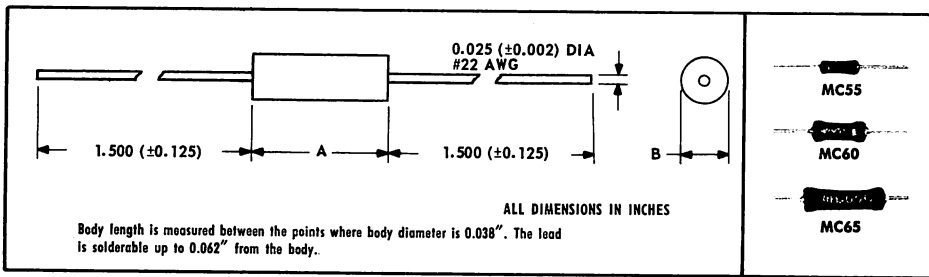

MIL-R-10509F DESIGNATION			ELECTRICAL RATINGS AND CHARACTERISTICS				MECHANICAL DATA		
type	applicable characteristic	power rating†	TI TYPE	power rating‡	maximum working voltage	resistance value range§ (T _A = 25°C)	body size		average weight for 100 unpacked units
							length — A	diameter — B	
		W		W	V		inch	inch	lb
RN55	C & E	1/10	MC55	1/8	250	24.9 Ω to 100 k Ω	0.250 (±0.031)	0.095 (±0.015)	0.075
	D	1/8	MC55D	1/4					
RN60	C & E	1/8	MC60	1/4	300	49.9 Ω to 499 k Ω	0.375 (±0.031)	0.140 (±0.015)	0.101
	D	1/4	MC60D	3/8					
RN65	C & E	1/4	MC65	1/2	350	49.9 Ω to 1 M Ω	0.575 (±0.031)	0.171 (±0.015)	0.198
	F	1/2							
	D	1/2	MC65D	1					

symbolization

Standard stock symbolization includes TI Type Number, Resistance Value, Tolerance, and Temperature Coefficient, depending upon wattage size and space available. Military type symbolization is used when applicable. Resistance values are symbolized to a maximum of three significant figures per Table 1.

military devices

The resistors are available in accordance with the requirements of MIL-R-10509F. For current availability of resistance values, tolerances, and characteristics consult a TI Sales Office.

modifications available upon request

Special testing
"A" nickel weldable leads

Resistance values outside published ranges
Special paint coverage

†These ratings apply at (or below) 125°C ambient temperature for characteristics C, E, and F and at (or below) 70°C ambient temperature for characteristic D. For higher temperatures refer to MIL-R-10509F.

‡These ratings apply at (or below) 125°C ambient temperature for MC55, MC60, and MC65 and at (or below) 70°C ambient temperature for "D" suffix devices. For higher temperatures refer to Power Dissipation Derating Curves Page 2.

§The value ranges shown are for a temperature coefficient of 25 ppm. See "high- and low-value availability" on Page 2.



TEXAS INSTRUMENTS
INCORPORATED
POST OFFICE BOX 5012 • DALLAS, TEXAS 75222

TYPES MC55, MC60, MC65, MC55D, MC60D, MC65D EPOXY-ENCAPSULATED PRECISION METAL-FILM RESISTORS

RESISTANCE VALUE

standard values and tolerance

The following resistance values are standard and in most cases are available from stock. Nonstandard values will be manufactured to specific requirements.

TABLE 1 — 1% TOLERANCE

1.00	1.10	1.21	1.33	1.47	1.62	1.78	1.96	2.15	2.37	2.61	2.87	3.16	3.48	3.83	4.22	4.64	5.11	5.62	6.19	6.81	7.50	8.25	9.09
1.02	1.13	1.24	1.37	1.50	1.65	1.82	2.00	2.21	2.43	2.67	2.94	3.24	3.57	3.92	4.32	4.75	5.23	5.76	6.34	6.98	7.68	8.45	9.31
1.05	1.15	1.27	1.40	1.54	1.69	1.87	2.05	2.26	2.49	2.74	3.01	3.32	3.65	4.02	4.42	4.87	5.36	5.90	6.49	7.15	7.87	8.66	9.53
1.07	1.18	1.30	1.43	1.58	1.74	1.91	2.10	2.32	2.55	2.80	3.09	3.40	3.74	4.12	4.53	4.99	5.49	6.04	6.65	7.32	8.06	8.87	9.76

Standard stock tolerance is $\pm 1\%$ (F). Tolerances of $\pm 0.5\%$ (D), $\pm 0.25\%$ (C), and $\pm 0.1\%$ (B) are also available upon request. The MC-D series is also available with $\pm 2\%$ tolerance. The parenthetical letters are equivalent MIL-R-10509F tolerance designations.

temperature coefficient

T-C Code Designation	Comparable MIL-R-10509F Characteristic	T-C Range	Temperature Range
T-1	D	± 100 ppm/ $^{\circ}\text{C}$	-55° to $+175^{\circ}\text{C}$
T-2	C & F	± 50 ppm/ $^{\circ}\text{C}$	-55° to $+175^{\circ}\text{C}$
T-9	E	± 25 ppm/ $^{\circ}\text{C}$	-55° to $+175^{\circ}\text{C}$
T-10		± 10 ppm/ $^{\circ}\text{C}$	$+25^{\circ}$ to $+150^{\circ}\text{C}$

Special tracking requirements, temperature ranges, etc., are available.

hi- and low-value availability

The range of available resistance values is dependent upon temperature coefficient, e.g., the available range is extended for temperature coefficient of 100 ppm compared to 25 ppm. Contact a TI sales office for extended value ranges currently available in each T-C range.

POWER RATING AND PERFORMANCE CHARACTERISTICS

power dissipation derating curves

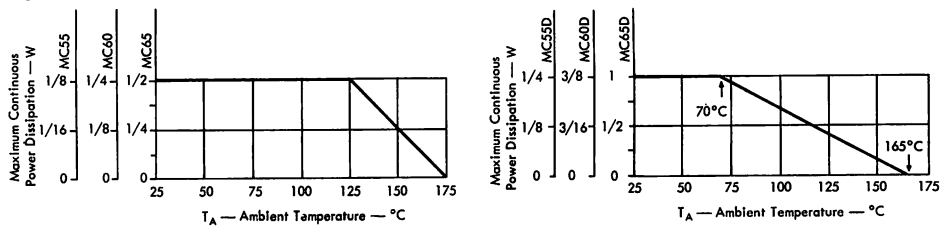

performance characteristics

Resistance-value stability is affected by power dissipation in operational-environment tests. Following are two typical examples. In one, the more stable MC series is tested to a low-power MIL-R-10509 application demonstrating maximum stability. In the other example, the lower-cost MC-D series is tested at its maximum TI-rated power to demonstrate its excellent stability under these extreme power conditions.

TEST PER APPLICABLE MIL-R-10509F PROCEDURE	MC55, MC60, MC65		MC55D, MC60D, MC65D	
	MIL-R-10509F Char E LIMITS	TI TYPICAL PERFORMANCE	MIL-R-10509F Char D LIMITS	TI TYPICAL PERFORMANCE
1000-Hour Load Life	$\pm 0.50\%$ max	$+0.14\%$ avg	$\pm 1.0\%$	$+0.30\%$ avg [■]
Moisture Resistance	$\pm 0.50\%$ max	$+0.15\%$ avg	$\pm 1.5\%$	$+0.40\%$ avg [■]
Low-Temperature Operation	$\pm 0.25\%$ max	$< \pm 0.05\%$	$\pm 0.50\%$	$+0.10\%$ avg
Temperature Cycling	$\pm 0.25\%$ max	$< \pm 0.05\%$	$\pm 0.50\%$	$< \pm 0.05\%$
Short-Time Overload	$\pm 0.25\%$ max	$< \pm 0.05\%$	$\pm 0.50\%$	$+0.10\%$ avg [■]
Effect of Soldering	$\pm 0.10\%$ max	$< \pm 0.05\%$	$\pm 0.50\%$	$< \pm 0.05\%$
Insulation Resistance	$> 10^{10} \Omega$	$> 10^{12} \Omega$	$> 10^{10} \Omega$	$> 10^{12} \Omega$ [■]
Shock	$\pm 0.25\%$ max	$< \pm 0.05\%$	$\pm 0.50\%$	$< \pm 0.05\%$
Vibration	$\pm 0.25\%$ max	$< \pm 0.05\%$	$\pm 0.50\%$	$< \pm 0.05\%$

Unless otherwise noted, data is percent change from initial resistance. [■] Operated at maximum TI-rated power.



**HERMETICALLY SEALED, TEMPERATURE-SENSING, TEMPERATURE-COMPENSATING
POSITIVE-TEMPERATURE-COEFFICIENT THERMISTOR**

- **Designed to meet or exceed all electrical requirements of MIL-T-23648A for positive-TC thermistors**

TYPE TG 1/8
BULLETIN NO. DLS-668132, JUNE 1966

mechanical data

The resistors are encapsulated in a hard-glass, hermetically sealed package with welded unborated solder-coated dumet leads.

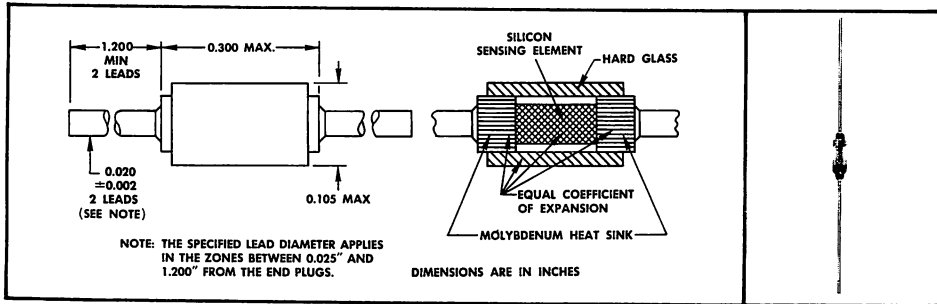

maximum ratings

Power Dissipation at (or below) 25°C Ambient Temperature (See Figure 1)	250 mW
Power Dissipation at 100°C Ambient Temperature (See Figure 1)	125 mW
Operating Ambient Temperature Range	-65°C to 150°C
Storage Temperature Range	-65°C to 150°C

electrical and thermal characteristics

Zero-Power Resistance Ratio, $R_{25^{\circ}\text{C}}/R_{125^{\circ}\text{C}}$	$0.55 \pm 15\%$
Thermal Time Constant, τ	60 s max, 35 s typ

standard zero-power resistance values (ohms) at 25°C ambient temperature

10	12	15	18	22	27	33	39	47	50	56	68	82
100	120	150	180	220	270	330	390	470	500	560	680	820
1000	1200	1500	1800	2200	2700							

Standard stock tolerances are $\pm 5\%$ and $\pm 10\%$



TYPE TG 1/8

SOLID-STATE TEMPERATURE-SENSING RESISTOR

performance characteristics

TEST PER APPLICABLE MIL-T-23648A PROCEDURE	MAXIMUM RESISTANCE CHANGE, $T_A=25^\circ\text{C}$
Short-Time Overload	$\pm 1\%$
Dielectric Withstanding Voltage	$\pm 1\%$
Low-Temperature Storage	$\pm 1\%$
High-Temperature Storage	$\pm 2\%$
Terminal Strength	$\pm 1\%$
Thermal Shock	$\pm 2\%$
Resistance to Soldering Heat	$\pm 1\%$
Moisture Resistance	$\pm 2\%$
1000-Hour Load Life, $T_A = 100^\circ\text{C}$	$\pm 2\%$
Vibration, High-Frequency	$\pm 1\%$
Shock	$\pm 1\%$
Immersion	$\pm 1\%$

military applications

The SENSISTOR silicon resistor has been designed to operate under military test conditions as stated above. Production lots are regularly tested to these criteria as part of TI's continuing process-control testing program.

Special methods have been developed for load-life and temperature-coefficient testing. Test details, recommended test parameters, and test results are available upon request.

nominal resistance multiplying factor vs ambient temperature

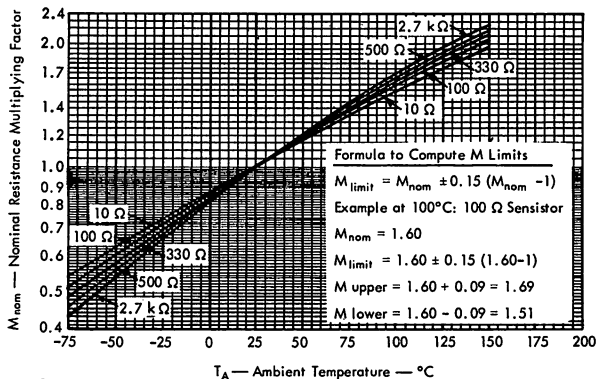

dissipation derating curve

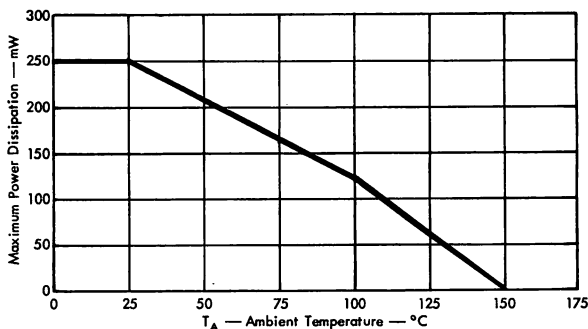



TYPES TM 1/8, TM 1/4, TC 1/8 AND P-100 PROBE SOLID-STATE TEMPERATURE-SENSING SILICON RESISTORS



TYPES TM 1/8, TM 1/4, TC 1/8 AND P-100 PROBE
BULLETIN NO. DLS-679254, JANUARY 1967
REPLACES BULLETIN NO. DLS-611284

Temperature Compensating • Temperature Sensing POSITIVE-TEMPERATURE-COEFFICIENT THERMISTORS

Amplifiers • Power Supplies • Servos • Thermometry
Mag Amps • Computers • Telemetry

Large positive temperature coefficient of resistance (approx. 0.7%/deg)



**Molded
Silicon Types TM 1/4 & TM 1/8**
Axial Leads
Full Load at 100°C
Derated Linearly to 150°C

mechanical data

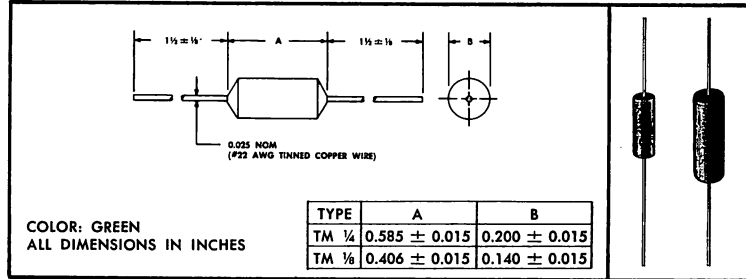

**Round Welded Case
Silicon Type TC 1/8**
Glass-to-Metal Hermetic Seal
Between Case and Leads
Full Load at 100°C
Derated Linearly to 150°C

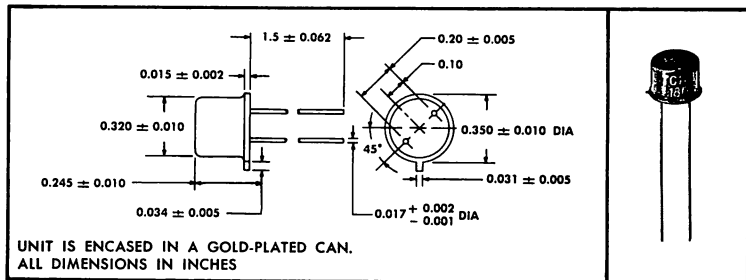

**Glass-Encased
Silicon Type P-100 Probe**
All Glass Package
Glass-to-Metal Hermetic
Seal at Leads
Accurate
Resistance-Temperature Relationship
From -180°C to +200°C

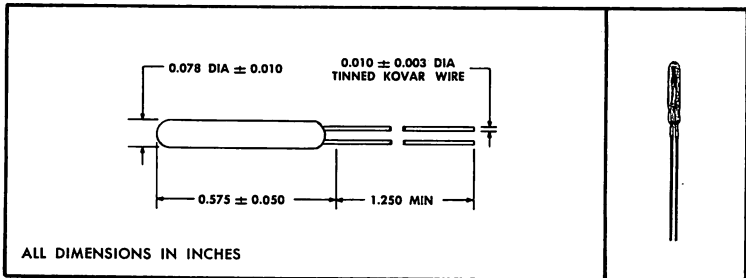

TEXAS INSTRUMENTS
INCORPORATED
POST OFFICE BOX 5012 • DALLAS, TEXAS 75222

TYPES TM 1/8, TM 1/4, TC 1/8 AND P-100 PROBE SOLID-STATE TEMPERATURE-SENSING SILICON RESISTORS

TM 1/8, TM 1/4, & TC 1/8

POWER DERATING CURVE

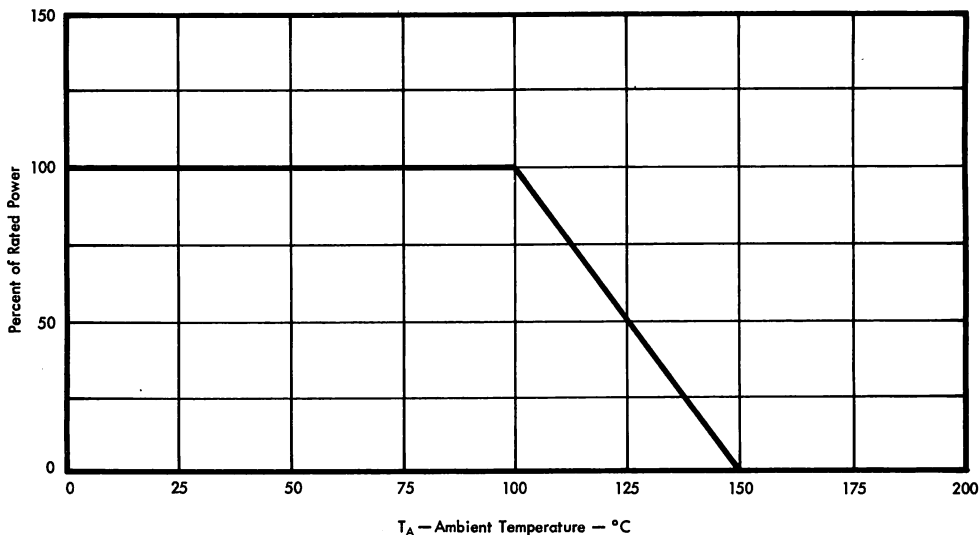

performance characteristics

TEST PER APPLICABLE MIL-T-23648A PROCEDURE	MAXIMUM RESISTANCE CHANGE, T _A = 25°C
Short-Time Overload	±1%
Dielectric Withstanding Voltage	±1%
Low-Temperature Storage	±1%
High-Temperature Storage	±2%
Terminal Strength	±1%
Thermal Shock	±2%
Resistance to Soldering Heat	±1%
Moisture Resistance	±2%
1000-Hour Load Life, T _A = 100°C	±2%
Vibration, High-Frequency	±1%
Shock	±1%
Immersion	±1%

military applications

The SENSISTOR silicon resistor has been designed to operate under military test conditions as stated above. Production lots are regularly tested to these criteria as part of TI's continuing process-control testing program.

Special methods have been developed for load-life and temperature-coefficient testing. Test details, recommended test parameters, and test results are available upon request.

TYPES TM 1/8, TM 1/4, TC 1/8 AND P-100 PROBE SOLID-STATE TEMPERATURE-SENSING SILICON RESISTORS

TYPICAL CHARACTERISTICS

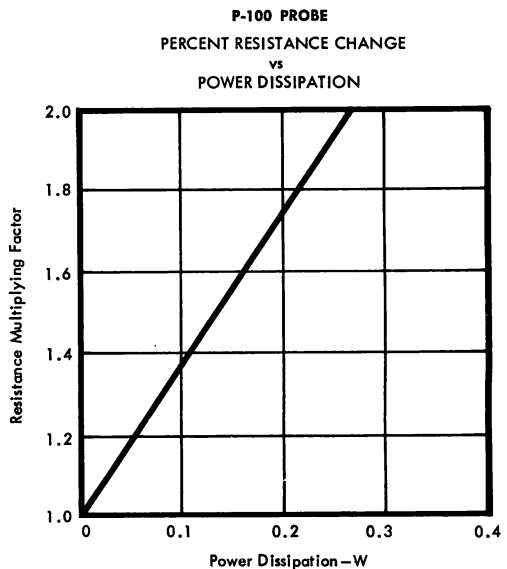
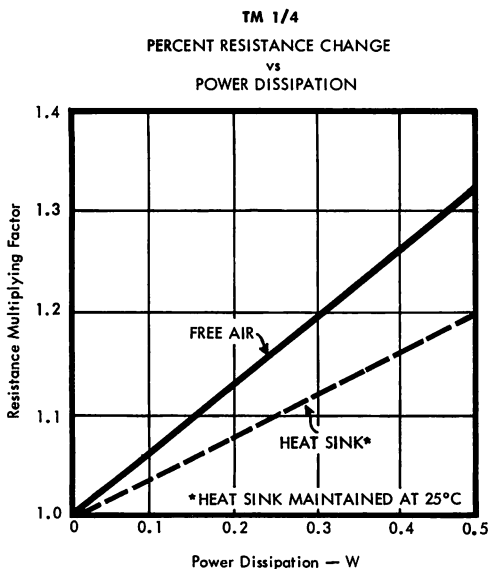
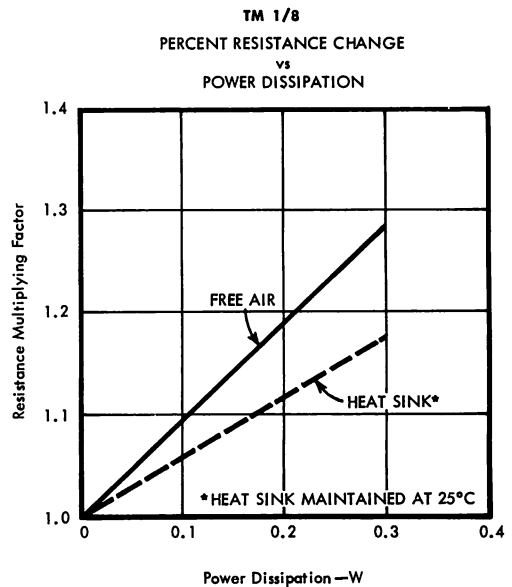
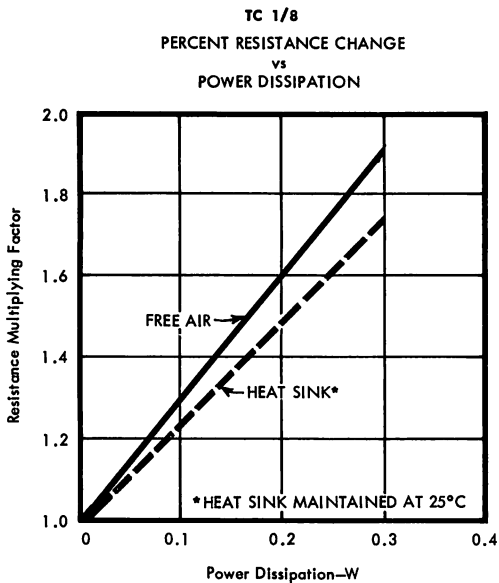

To correct resistance value for self-heating effect, determine correction factor from the above curve. Choose the nearest approximate heat-dissipation condition (free still air or strapped to the chassis or heat sink). Multiply the factor thus obtained by resistor value which has been corrected for no-load ambient temperature if necessary.

TYPES TM 1/8, TM 1/4, TC 1/8 AND P-100 PROBE SOLID-STATE TEMPERATURE-SENSING SILICON RESISTORS

electrical specifications

	TC 1/8	TM 1/8	TM 1/4	P-100	UNIT
Wattage Rating	1/8	1/8	1/4	not applicable	W
Standard Resistance Range*	10 - 5600	10 - 5600	10 - 10,000	100 - 4000	Ω
Maximum Thermal Time Constant	60	40	60	11	s

*Resistances calibrated at $25^{\circ}\text{C} \pm 0.20^{\circ}\text{C}$; resistance tolerance $\pm 10\%$.

standard resistance values (ohms) for 1 to 10 decade† – TM 1/8, TM 1/4, and TC 1/8

1.0	1.2	1.5	1.8	2.2	2.7	3.3
3.9	4.7	5.0	5.6	6.8	8.2	

†Resistance values not listed will be considered nonstandard.

standard resistance values (ohms) – P-100 Probe

100 500 1000 2000 4000

$\pm 5\%$ tolerances, matched pairs, and other resistance values available as special devices.

nominal resistance multiplying factor vs ambient temperature

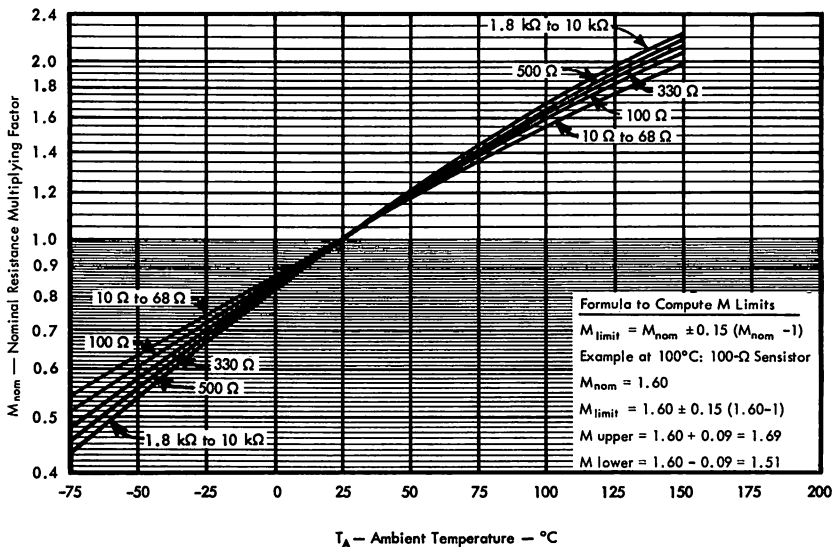

NOTES

NOTES

NOTES

NOTES

NOTES

NOTES

TI world-wide sales offices

ALABAMA

Sahara Office Park Bldg., Suite 111
3313 Memorial Parkway, S.W.
Huntsville, Alabama 35801
205-881-4061

ARIZONA

2535 W. Camelback Rd., Suite 1D
Phoenix, Arizona 85017
602-279-5531

CALIFORNIA

1800 North Argyle Ave.
Hollywood, California 90028
213-466-7251

5005 West Century Blvd., Suite 208
Inglewood, California 90301
213-673-3943

230 California Ave., Suite 201
Palo Alto, California 94306
415-326-6770

1505 East 17th St., Suite 201
Santa Ana, California 92701
714-547-6506

4185 Adams Ave.
San Diego, California 92116
714-284-1181

COLORADO

2186 South Holly St., Suite 204
Denver Colorado 80222
303-757-8548

CONNECTICUT

300 Amity Road
Woodbridge, Connecticut 06525
203-389-4521

FLORIDA

618 East South St., Suite 114
Orlando, Florida 32801
305-422-9894

ILLINOIS

Suite 205, Executive Towers
5901 N. Cicero Ave.
Chicago, Illinois 60646
312-286-1000

MASSACHUSETTS

60 Hickory Drive
Waltham, Mass. 02154
617-891-8450

MICHIGAN

Suite 706 West, Northland Towers Bldg.
15565 Northland Dr.
Southfield, Michigan 48075
313-357-1703

MINNESOTA

7615 Metro Blvd.
Suite 202, U.C.L.I. Bldg.
Edina, Minn. 55424
612-941-4384

NEW JERSEY

25 U.S. Highway 22
Springfield, New Jersey 07081
201-376-9400

NEW YORK

P. O. Box 87, 2209 E. Main
Endicott, New York 13760
607-785-9987

4 Nevada Drive
New Hyde Park, N. Y. 11040
516-488-9894

131 Fulton Ave., Apt. J-2
Poughkeepsie, New York 12603
914-471-6095

6563 Ridings Rd.
Syracuse, New York 13206
315-463-9291

OHIO

22035 Chagrin Blvd.
Cleveland, Ohio 44122
216-751-2600

Suite 205, Paul Welch Bldg.
3300 South Dixie Dr.
Dayton, Ohio 45439
513-298-7513

PENNSYLVANIA

Benjamin Fox Pavilion
Suite 424, Foxcroft Square
Jenkintown, Pa. 19046
215-885-3454

TEXAS

MS80 — P.O. Box 5012
Dallas, Texas 75222
214-238-4861

3609 Buffalo Speedway
Houston, Texas 77006
713-526-3268

WASHINGTON

5801 Sixth Ave. S.
Seattle, Washington 98108
206-762-4240

WASHINGTON, D.C.

1875 Connecticut Ave., N.W., Suite 913
Washington, D.C. 20009
202-234-9320

CANADA

Geophysical Service Incorporated
280 Centre Str. East
Richmond Hills
Ontario, Canada
925-1035

663 Orly Avenue
Dorval
Quebec, Canada
631-6010

EUROPE

Texas Instruments Limited
Manton Lane
Bedford, England

Texas Instruments France S. A.
Boite Postale 5
Villeneuve-Loubet (A.M.), France

11 rue de Madrid
Paris 8^e, France

Texas Instruments Holland N.V.
Semiconductor Division
Enschedeestraat 19
Hengelo (Ov), Holland

Texas Instruments Italia S.p.A.
Via Colautti 1
Milan, Italy

Texas Instruments Incorporated
118 Rue du Rhone
1204 Geneva, Switzerland

Texas Instruments Sweden A.B.
Timmermangatan 34, Box 17116
Stockholm 17, Sweden

Texas Instruments Deutschland GmbH
Hildesheimerstr. 19
3 Hannover, W. Germany

Texas Instruments Deutschland GmbH
Wolframstrasse 26
7 Stuttgart
West Germany

Texas Instruments Deutschland GmbH
Clemensstrasse 30
8 Munich 23
West Germany

Texas Instruments Deutschland GmbH
Kepserstrasse 33
805 Freising-Lerchenfeld
West Germany

Texas Instruments Deutschland GmbH
Koenigsbacherstrasse 22
6 Frankfurt, West Germany

MEXICO

Texas Instruments de Mexico S.A.
Poniente 116 #489
Col. Ind. Vallejo
Mexico 15, D.F.

ARGENTINA

Texas Instruments Argentina S.A.I.C.F.
(P. O. Box 2296 — Correo Central)
Ruta Panamericana Km. 13, 5
Don Torcuato
Buenos Aires, Argentina

BRAZIL

Texas Instrumentos Electronicos
do Brazil Ltda.
Rua Cesario Alvim 770
Caixa Postal 30.103
Sao Paulo 6, Brazil

AUSTRALIA

Texas Instruments Australia Ltd.
Box 63, Oldham Road
Elizabeth, South Australia

Texas Instruments Australia Ltd.
Room 5, Rural Bank Bldg.
Burwood, N.S.W., Australia

JAPAN

Texas Instruments Asia Limited
404 T.B.R. Building
No. 59, 2-chome, Nagata-cho
Chiyoda-ku, Tokyo, Japan